

# ETP HYDRO-FIX®

Hydraulic high precision clamping unit

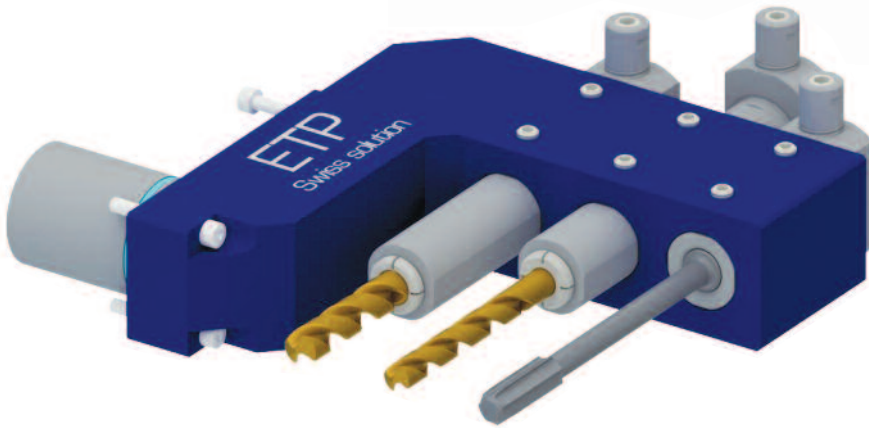

Swiss type  
Lathes

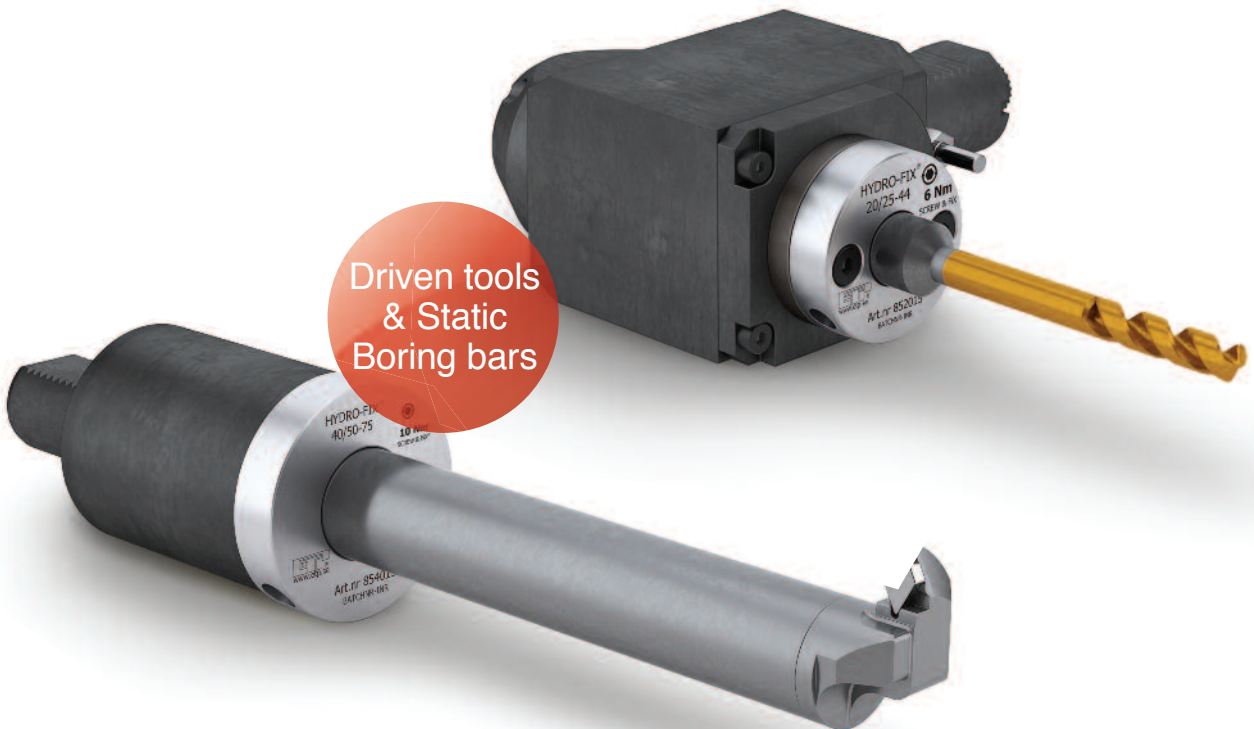

Driven tools  
& Static  
Boring bars



# Increases your productivity!



ETP HYDRO-FIX S clamping units are excellent for static front and back operations such as drilling, reaming and boring. With the one screw fix system it is quick and easy to handle. Precision hydraulic tool centering is achieved and therefore the tool life and setup time is improved. The clamping unit allows for larger/deeper drilling, quick tool changes, absorbs/reduces vibration, improves surface quality and best of all: increases your productivity!

## Static front & back working tools

### BENEFITS & FEATURES

- Replaces ER11 – ER32 collet holders
- Use larger and longer tools
- Shank clamping range: 1 to 25 mm and 1/8" to 13/16" using reduction sleeves
- Quick and easy handling
- Reduced vibrations
- Improved surface quality
- Increased tool life

## Designs

### Cylindrical

Hydraulic clamping on the tool shank and expansion of the holder inside the machine block!

Perfect centering



### Flat

Hydraulic clamping on the tool shank!

Easy length adjustability



# Swiss machine turning – with ETP HYRO-FIX S hydraulic high precision clamping unit



Front activation version in Drill arm application. Tool change in 30 seconds!



Back activation version in Drill arm application. Tool change in 30 seconds!

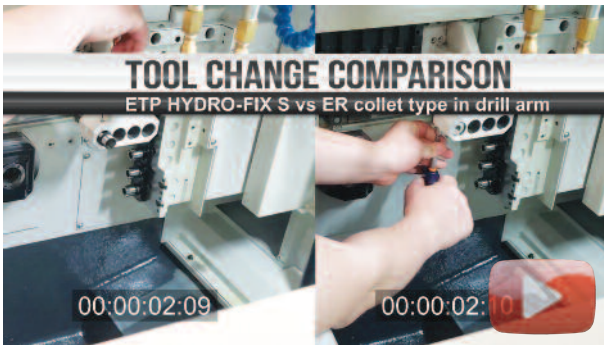

HYDRO-FIX S vs ER collet type tool holder in Drill arm application. Save valuable time in set-up and tool changes!

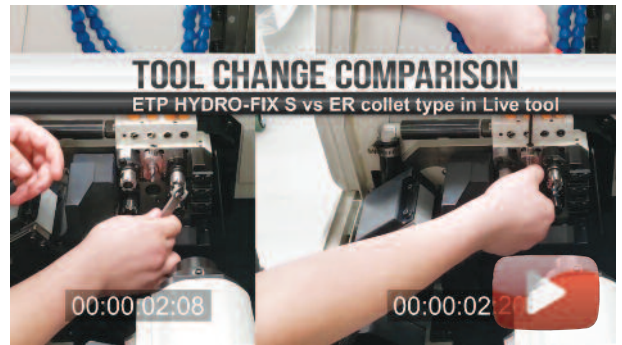

HYDRO-FIX S vs ER collet type tool holder in Live tool station for static drilling. Save valuable time in set-up and tool changes!

[youtube.com/etptransmission](https://youtube.com/etptransmission)

Follow us on YouTube

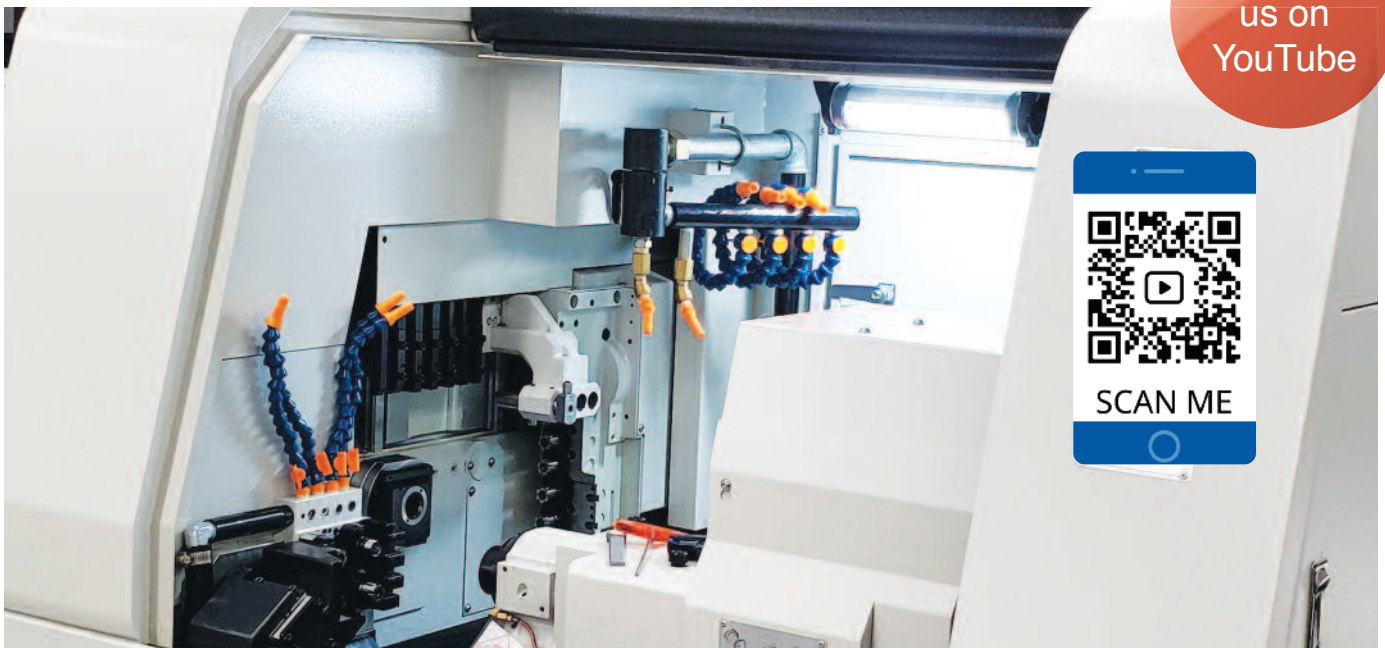

# ETP HYDRO-FIX SFC®

Front activation – Cylindrical design

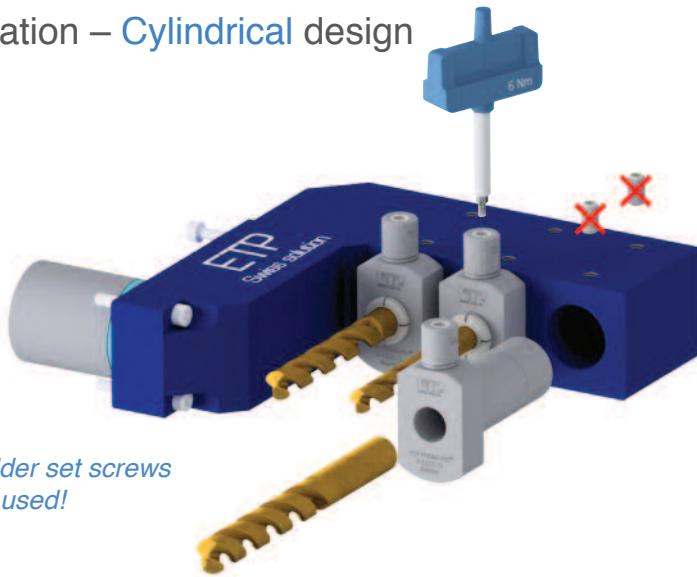

Block/holder set screws are **NOT** used!



Perfect centering

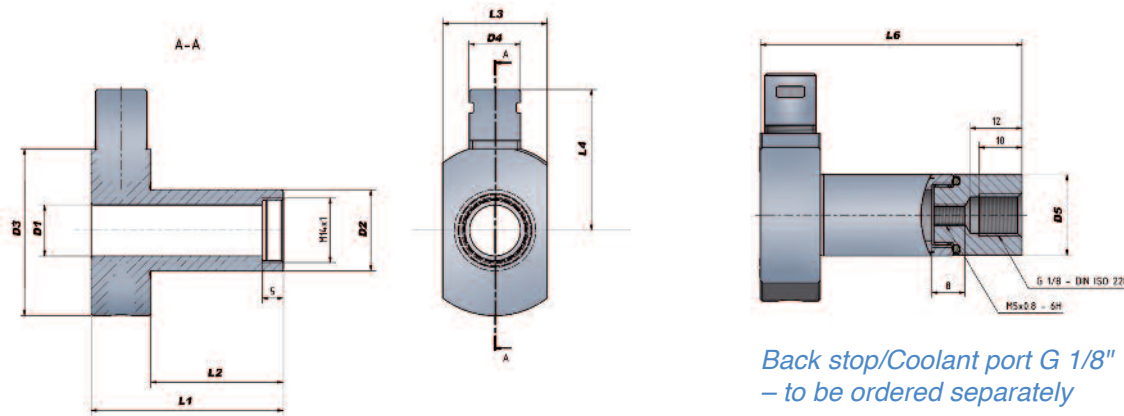

Back stop/Coolant port G 1/8" – to be ordered separately

## Technical Specification

Part no.	Item description	Dimensions, mm								Dimensions with Back stop/Coolant port G 1/8"		
		D1*	D2**	D3	D4	L1	L2	L3	L4	L6	D5	Part no. - Back stop/Coolant port G 1/8" Includes adjustment screw M5x0.8-16***
● 664090	HYDRO-FIX SFC-12/3/4"-31	12	19.05	40	12	45	31	21.5	33	61	18.85	664000-10
○ 664100	HYDRO-FIX SFC-12/20-31	12	20	40	12	45	31	22.5	33	61	18.85	664000-10
● 663740	HYDRO-FIX SFC-12/22-31	12	22	40	12	45	31	24.5	33	61	18.85	664000-10
○ 664110	HYDRO-FIX SFC-12/25-31	12	25	40	12	45	31	27.5	33	61	18.85	664000-10
● 664120	HYDRO-FIX SFC-12/1"-31	12	25.4	40	12	45	31	27.5	33	61	18.85	664000-10
● 663750	HYDRO-FIX SFC-20/25-30*	20	25	44	12	44	30	27.5	35			
○ 664130	HYDRO-FIX SFC-20/1"-30*	20	25.4	44	12	44	30	27.5	35			
● 664140	HYDRO-FIX SFC-25/1 1/4"-34*	25	31.75	50	12	48	34	34.5	38			
● 663760	HYDRO-FIX SFC-25/32-34*	25	32	50	12	48	34	34.5	38			

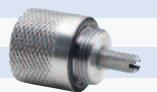

\*) These sizes are **NOT** threaded with an M14x1 for a Back stop/coolant port. Pressure screw angled 15°.



- From stock
- On request

### Information:

- \*) Tool/toolbar shank h6 or h7 can be used.
- \*\*) Recommended tolerance of toolholder bore - H7.
- \*\*\*) Adjustment screw M5x0.8-16 can also be ordered separately as spare part. Part no. S041

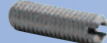

### Accessories:

Use preset Torque Wrench to ensure correct mounting of tools. 6 Nm - Part no. 19055



ETP HYDRO-FIX can be used with reduction sleeves. For additional information see section Accessories.



### Adaptors:

Male G 1/8" to Female 1/8" NPT Part no. 19151

Male G 1/8" to Male 1/4" JIC Part no. 19150

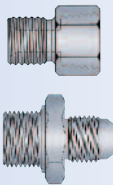

# ETP HYDRO-FIX SFF®

Front activation – Flat design

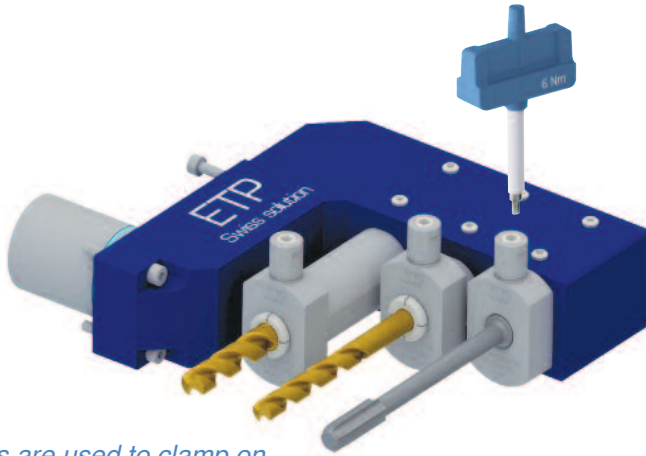

Easy length adjustability



Set screws are used to clamp on the milled flat, after adjusting the length of the assembly.

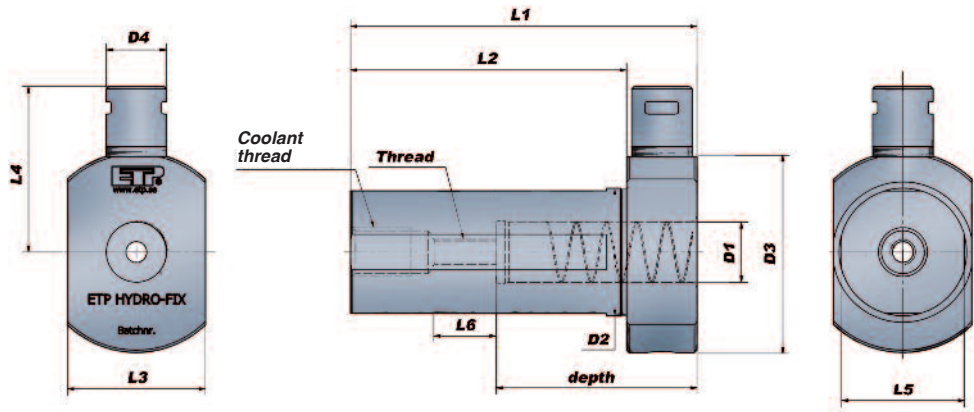

## Technical Specification

Part no.	Item description	Dimensions, mm											Thread	L6	Coolant thread DIN ISO 228
		D1	D2	D3	D4	L1	L2	depth	L3	L4	L5				
○ 706010	HYDRO-FIX SFF-12/3/4"-50	12	19.05	40	12	64	50	40	21.5	33	18.05	M5x0.8 - 6H	7	G 1/8	
○ 706158	HYDRO-FIX SFF-12/3/4"-75	12	19.05	40	12	89	75	40	21.5	33	18.05	M5x0.8 - 6H	16	G 1/8	
○ 706159	HYDRO-FIX SFF-12/20-75	12	20	40	12	89	75	40	22.5	33	19	M5x0.8 - 6H	16	G 1/8	
● 706012	HYDRO-FIX SFF-12/25-150	12	25	40	12	164	150	40	27.5	33	24	M5x0.8 - 6H	16	G 1/8	
○ 706053	HYDRO-FIX SFF-12/1"-55	12	25.4	40	12	69	55	40	27.5	33	24.4	M5x0.8 - 6H	12	G 1/8	
● 706011	HYDRO-FIX SFF-12/1"-100	12	25.4	40	12	114	100	40	27.5	33	24.4	M5x0.8 - 6H	16	G 1/8	

● From stock  
○ On request

### Information:

- \*) Tool/toolbar shank h6 or h7 can be used.
- \*\*) Recommended tolerance of toolholder bore - H7.

Adjustment screw M5x0.8-16 included in shipment. It can also be ordered separately as spare part. Part no. S041

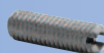

### Accessories:

Use preset Torque Wrench to ensure correct mounting of tools. 6 Nm - Part no. 19055



ETP HYDRO-FIX can be used with reduction sleeves. For additional information see section Accessories.



### Adaptors:

Male G 1/8" to Female 1/8" NPT Part no. 19151

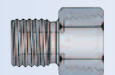

Male G 1/8" to Male 1/4" JIC Part no. 19150

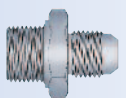

# ETP HYDRO-FIX SBF®

Back activation – Flat design

Easy length adjustability

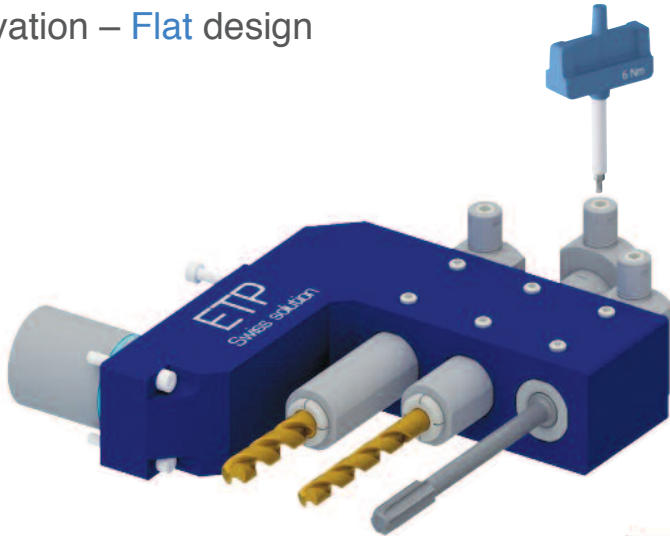

Set screws are used to clamp on the milled flat, after adjusting the length of the assembly.

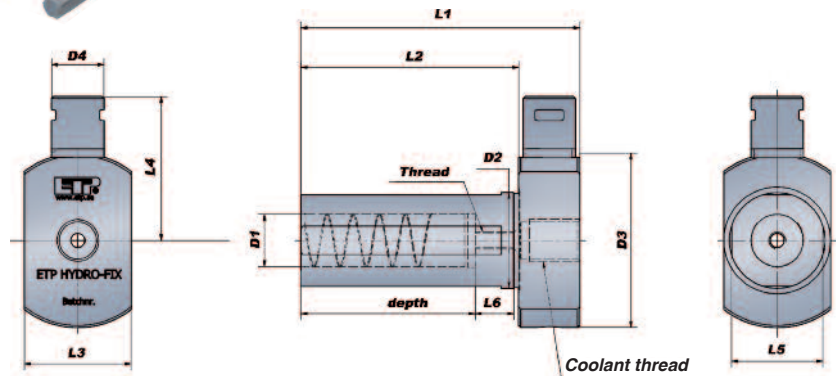

## Technical Specification

Dimensions, mm

Part no.	Item description	D1	D2	D3	D4	L1	L2	depth	L3	L4	L5	Thread	L6	Coolant thread DIN ISO 228
● 664000	HYDRO-FIX SBF-12/3/4"-50	12	19.05	40	12	64	50	40	21.5	33	21	M5x0.8 - 6H	9	G 1/8
● 664010	HYDRO-FIX SBF-12/3/4"-75	12	19.05	40	12	89	75	40	21.5	33	21	M5x0.8 - 6H	10	G 1/8
○ 664020	HYDRO-FIX SBF-12/3/4"-100	12	19.05	40	12	114	100	40	21.5	33	21	M5x0.8 - 6H	10	G 1/8
○ 664030	HYDRO-FIX SBF-12/20-75	12	20	40	12	89	75	40	22.5	33	21	M5x0.8 - 6H	10	G 1/8
○ 664040	HYDRO-FIX SBF-12/20-100	12	20	40	12	114	100	40	22.5	33	21	M5x0.8 - 6H	10	G 1/8
● 663700	HYDRO-FIX SBF-12/22-50	12	22	40	12	64	50	40	24.5	33	21	M5x0.8 - 6H	9	G 1/8
● 663770	HYDRO-FIX SBF-12/22-75	12	22	40	12	89	75	40	24.5	33	21	M5x0.8 - 6H	10	G 1/8
● 663720	HYDRO-FIX SBF-12/22-100	12	22	40	12	114	100	40	24.5	33	21	M5x0.8 - 6H	10	G 1/8
● 663780	HYDRO-FIX SBF-12/22-115	12	22	40	12	129	115	40	24.5	33	21	M5x0.8 - 6H	10	G 1/8
● 663710	HYDRO-FIX SBF-12/25-50	12	25	40	12	64	50	40	27.5	33	24	M5x0.8 - 6H	9	G 1/8
● 663790	HYDRO-FIX SBF-12/25-75	12	25	40	12	89	75	40	27.5	33	24	M5x0.8 - 6H	10	G 1/8
● 663730	HYDRO-FIX SBF-12/25-100	12	25	40	12	114	100	40	27.5	33	24	M5x0.8 - 6H	10	G 1/8
● 664050	HYDRO-FIX SBF-12/1"-50	12	25.4	40	12	64	50	40	27.5	33	24	M5x0.8 - 6H	9	G 1/8
○ 664060	HYDRO-FIX SBF-12/1"-75	12	25.4	40	12	89	75	40	27.5	33	24	M5x0.8 - 6H	10	G 1/8
● 664070	HYDRO-FIX SBF-12/1"-100	12	25.4	40	12	114	100	40	27.5	33	24	M5x0.8 - 6H	10	G 1/8
○ 664080	HYDRO-FIX SBF-20/32-50	20	32	40	12	64	50	52	34.5	33	30.8	M5x0.8 - 6H	9	–
○ 663810	HYDRO-FIX SBF-20/32-75	20	32	40	12	89	75	52	34.5	33	30.8	M5x0.8 - 6H	10	G 1/8
○ 663820	HYDRO-FIX SBF-20/32-100	20	32	40	12	114	100	52	34.5	33	30.8	M5x0.8 - 6H	10	G 1/8

● From stock  
○ On request

### Information:

- \*) Tool/toolshank h6 or h7 can be used.
- \*\*) Recommended tolerance of toolholder bore - H7.

Adjustment screw M5x0.8-16 included in shipment. It can also be ordered separately as spare part. Part no. S041

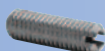

### Accessories:

Use preset Torque Wrench to ensure correct mounting of tools. 6 Nm - Part no. 19055



ETP HYDRO-FIX can be used with reduction sleeves. For additional information see section Accessories.



### Adaptors:

Male G 1/8" to Female 1/8" NPT Part no. 19151

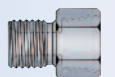

Male G 1/8" to Male 1/4" JIC Part no. 19150

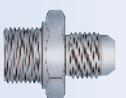

# ETP HYDRO-FIX®

For Driven tools & Static Boring bars

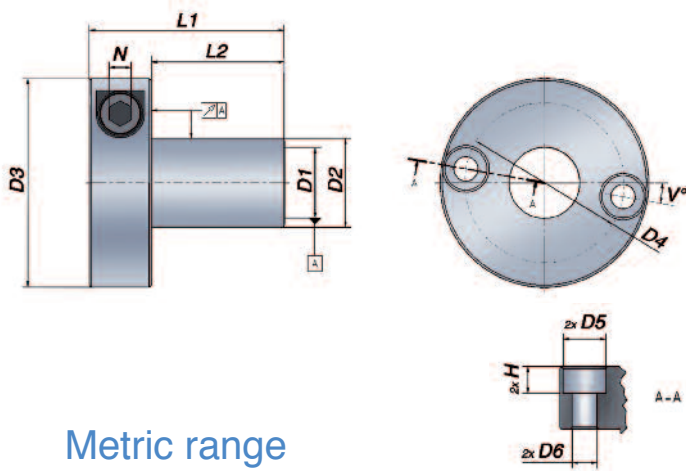

## Metric range

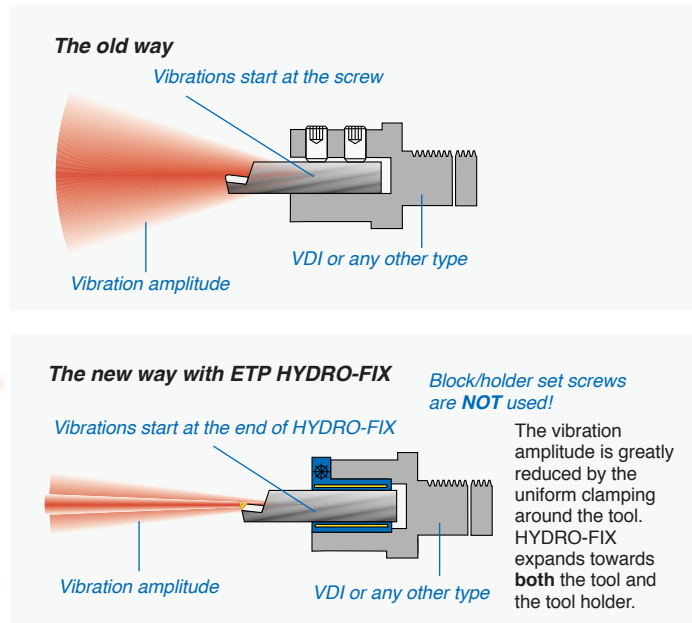

### Technical Specification

Part no.	Item description	Dimensions, mm					Recommended screws DIN 915, 12.9					Pressure screw		Runout mm	T* Nm	Weight kg
		D1*	D2**	D3	L1	L2	D4	D5	D6	H	V°	N	Tt*** Nm			
● 851215	HYDRO-FIX 12/16-38	12	16	43.5	38	24	28	9.5	5.5	6	5	5	6	0.006	60	0.15
● 851615	HYDRO-FIX 16/20-44	16	20	47	44	30	36	9.5	5.5	6	10	5	6	0.006	165	0.17
● 852015	HYDRO-FIX 20/25-44	20	25	52	44	30	36	11	6.5	7	5	6	0.006	260	0.21	
● 852515	HYDRO-FIX 25/32-48	25	32	59	48	34	44	11	6.5	7	5	6	0.010	350	0.30	
● 853215	HYDRO-FIX 32/40-53	32	40	69.5	53	39	52	11	6.5	7	5	6	0.010	630	0.43	
○ 854015	HYDRO-FIX 40/50-69	40	50	79	69	55					5	6	0.015	320	0.96	
○ 854215	HYDRO-FIX 42/50-76	42	50	89	76	56					8	10	0.015	800	0.94	
○ 855015	HYDRO-FIX 50/60-80	50	60	98.5	80	60					8	10	0.015	800	1.23	
○ 856015	HYDRO-FIX 60/80-90	60	80	115.5	90	70					8	10	0.015	800	2.34	

## Inch range

### Technical Specification

Part no.	Item description	Dimensions, inch					Recommended screws DIN 915, 12.9					Pressure screw		Runout inch	T* ft·lb	Weight kg
		D1*	D2**	D3	L1	L2	D4	D5	D6	H	V°	N	Tt*** Nm			
● 851315	HYDRO-FIX 1/2"/5/8"-38	0.500	0.625	1.713	1.496	0.945	1.102	0.374	0.217	0.236	5	0.197	6	0.00024	44	0.15
● 851515	HYDRO-FIX 5/8"/3/4"-44	0.625	0.750	1.850	1.732	1.181	1.417	0.374	0.217	0.236	10	0.197	6	0.00024	121	0.17
● 851915	HYDRO-FIX 3/4"/1"-44	0.750	1.000	2.047	1.732	1.181	1.417	0.433	0.256	0.276	5	0.197	6	0.00039	191	0.21
● 852615	HYDRO-FIX 1"/1 1/4"-48	1.000	1.250	2.323	1.890	1.339	1.732	0.433	0.256	0.276	5	0.197	6	0.00039	258	0.30
● 853115	HYDRO-FIX 1 1/4"/1 1/2"-53	1.250	1.500	2.736	2.087	1.535	2.047	0.433	0.256	0.276	5	0.197	6	0.00039	465	0.43
● 853915	HYDRO-FIX 1 1/2"/2"-69	1.500	2.000	3.110	2.717	2.165					5	0.197	6	0.00059	118	1.06
● 855115	HYDRO-FIX 2"/2 1/2"-80	2.000	2.500	3.996	3.150	2.362					10	0.315	10	0.00059	590	1.42
○ 856315	HYDRO-FIX 2 1/2"/3"-93	2.500	3.000	4.685	3.661	2.874					10	0.315	10	0.00059	885	1.98

\*\*\*)  $T_t$  = Recommended tightening torque for the screw in Nm! Further tightening does not increase the pressure.

\*) T = Transmittable torque using a h6 cylindrical tool, full depth (L1) insert.

For dimensions 12 mm (1/2") – 20 mm (3/4"):

When using a non-cylindrical tool/toolbar – we recommend the use of a reduction sleeve to avoid plastic deformation of ETP HYDRO-FIX.

● From stock

○ On request

### Information:

- \*) Tool/toolbar shank h6 or h7 can be used.
- \*\*\*) Recommended tolerance of toolholder bore - H7. Balanced by design. For use above 3 000 rpm - we recommend individual balancing.

### Accessories:

- Use preset Torque Wrench to ensure correct mounting of tools.
- 6 Nm - Part no. 19050
- 10 Nm - Part no. 19054



### Digital Spirit Level

- For easy toolbar alignment use the ETP Digital Spirit Level \*
- Part no. 885010



\*) 3x CR2032 battery - not included.

# Reduction Sleeves for ETP Clamping units



## Reduction sleeve HS - for internal cooling

The reduction sleeves are designed to fit with the ETP clamping units. They are specially suited for high precision clamping of cylindrical tool shanks per DIN 6335 form HA, HB and HE, as well as tool shanks per DIN 1835 form B, C, D and E.

The special design of the reduction sleeves allows an efficient use of coolant through cutting tools.



## Reduction sleeve HS-CF - for peripheral cooling.

Outer-Ø of reduction sleeve corresponds to the type.

HS12 = Ø 12 mm  
HS20 = Ø 20 mm  
HS25 = Ø 25 mm  
HS32 = Ø 32 mm

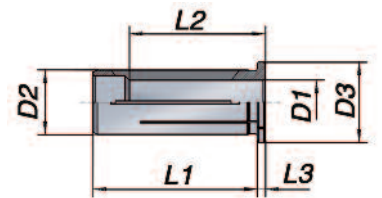

### BENEFITS & FEATURES

- Standard version HS suited for internal cooling**  
 Metal-to-metal seal for cutting tools with internal coolant channels.
- HS-CF version suited for peripheral cooling**  
 The coolant flush reduction sleeves HS-CF can be used for peripheral cooling due to their coolant channels.
- Accurate precision**  
 High runout accuracy < 3 µm.
- High flexibility**  
 Clamping of different tool shank diameters. 12, 20, 25, 32 mm and 1/2", 3/4", 1", 1 1/4".
- Power increase**  
 When using reduction sleeves the transmittable torque is increased.

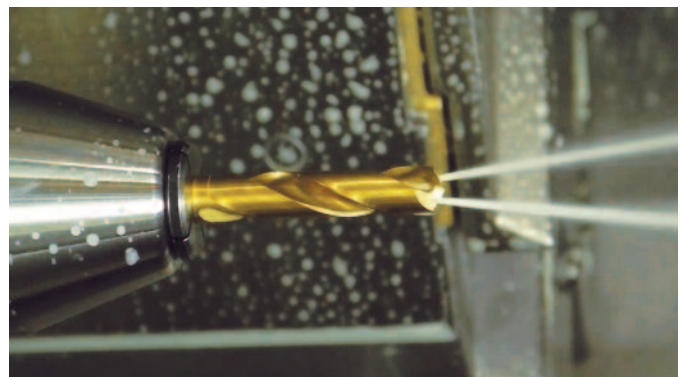

Using Reduction sleeve HS - for internal cooling.

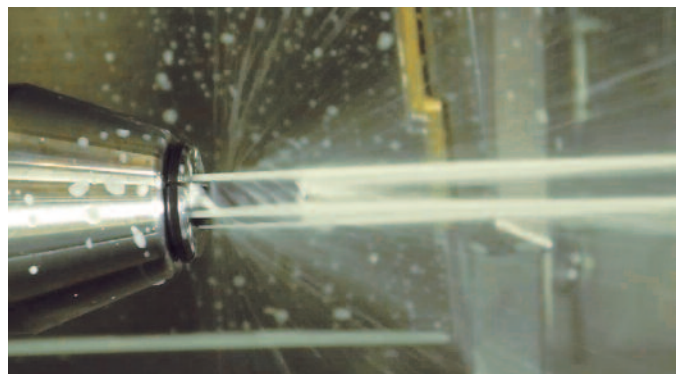

Using Reduction sleeve HS-CF - for peripheral cooling.



## Reduction Sleeves Inch to inch

## mm to inch

Reduction Sleeves inch to inch							
Part no.	Item description	D2 inch	D1 inch	D3 inch	L1 inch	L2 inch	L3 inch
Reduction Sleeves HS 1/2"							
● R1913.03182	HS 1/2" / 1/8"	0.500	0.1250	0.630	1.575	1.142	0.157
● R1913.04762	HS 1/2" / 3/16"	0.500	0.1875	0.630	1.575	1.142	0.157
● R1913.06352	HS 1/2" / 1/4"	0.500	0.2500	0.630	1.575	1.417	0.157
● R1913.07942	HS 1/2" / 5/16"	0.500	0.3125	0.630	1.575	1.457	0.157
● R1913.09522	HS 1/2" / 3/8"	0.500	0.3750	0.630	1.575	1.575	0.157
Reduction Sleeves HS 1/2"-CF							
● R1913.06353	HS 1/2"-CF / 1/4"	0.500	0.2500	0.630	1.575	1.417	0.157
● R1913.09523HS	1/2"-CF / 3/8"	0.500	0.3750	0.630	1.575	1.575	0.157
Reduction Sleeves HS 3/4"							
● R1919.03182	HS 3/4" / 1/8"	0.750	0.1250	0.984	1.969	1.102	0.157
● R1919.04762	HS 3/4" / 3/16"	0.750	0.1875	0.984	1.969	1.102	0.157
● R1919.06352	HS 3/4" / 1/4"	0.750	0.2500	0.984	1.969	1.417	0.157
● R1919.07942	HS 3/4" / 5/16"	0.750	0.3125	0.984	1.969	1.457	0.157
● R1919.09522	HS 3/4" / 3/8"	0.750	0.3750	0.984	1.969	1.417	0.157
● R1919.11112	HS 3/4" / 7/16"	0.750	0.4375	0.984	1.969	1.575	0.157
● R1919.12702	HS 3/4" / 1/2"	0.750	0.5000	0.984	1.969	1.772	0.157
● R1919.14292	HS 3/4" / 9/16"	0.750	0.5625	0.984	1.969	1.772	0.157
● R1919.15882	HS 3/4" / 5/8"	0.750	0.6250	0.984	1.969	1.890	0.157
Reduction Sleeves HS 3/4"-CF							
● R1919.06353	HS 3/4"-CF / 1/4"	0.750	0.2500	0.984	1.969	1.417	0.157
● R1919.09523	HS 3/4"-CF / 3/8"	0.750	0.3750	0.984	1.969	1.417	0.157
● R1919.12703	HS 3/4"-CF / 1/2"	0.750	0.5000	0.984	1.969	1.772	0.157
● R1919.15883	HS 3/4"-CF / 5/8"	0.750	0.6250	0.984	1.969	1.890	0.157
Reduction Sleeves HS 1"							
● R1926.03182	HS 1" / 1/8"	1.000	0.1250	1.181	2.205	1.142	0.157
○ R1926.04762	HS 1" / 3/16"	1.000	0.1875	1.181	2.205	1.142	0.157
● R1926.06352	HS 1" / 1/4"	1.000	0.2500	1.181	2.205	1.457	0.157
● R1926.07942	HS 1" / 5/16"	1.000	0.3125	1.181	2.205	1.457	0.157
● R1926.09522	HS 1" / 3/8"	1.000	0.3750	1.181	2.205	1.496	0.157
● R1926.11112	HS 1" / 7/16"	1.000	0.4375	1.181	2.205	1.575	0.157
● R1926.12702	HS 1" / 1/2"	1.000	0.5000	1.181	2.205	1.811	0.157
● R1926.14292	HS 1" / 9/16"	1.000	0.5625	1.181	2.205	1.850	0.157
● R1926.15882	HS 1" / 5/8"	1.000	0.6250	1.181	2.205	1.890	0.157
● R1926.17462	HS 1" / 11/16"	1.000	0.6875	1.181	2.205	1.890	0.157
● R1926.19052	HS 1" / 3/4"	1.000	0.7500	1.181	2.205	1.890	0.157
Reduction Sleeves HS 1"-CF							
● R1926.06353	HS 1"-CF / 1/4"	1.000	0.2500	1.181	2.205	1.457	0.157
● R1926.09523	HS 1"-CF / 3/8"	1.000	0.3750	1.181	2.205	1.496	0.157
● R1926.12703	HS 1"-CF / 1/2"	1.000	0.5000	1.181	2.205	1.811	0.157
● R1926.15883	HS 1"-CF / 5/8"	1.000	0.6250	1.181	2.205	1.890	0.157
● R1926.19053	HS 1"-CF / 3/4"	1.000	0.7500	1.181	2.205	1.890	0.157
Reduction Sleeves HS 1 1/4"							
○ R1931.04762	HS 1 1/4" / 3/16"	1.250	0.1875	1.417	2.362	1.142	0.157
● R1931.06352	HS 1 1/4" / 1/4"	1.250	0.2500	1.417	2.362	1.417	0.157
● R1931.07942	HS 1 1/4" / 5/16"	1.250	0.3125	1.417	2.362	1.417	0.157
● R1931.09522	HS 1 1/4" / 3/8"	1.250	0.3750	1.417	2.362	1.457	0.157
○ R1931.11112	HS 1 1/4" / 7/16"	1.250	0.4375	1.417	2.362	1.772	0.157
● R1931.12702	HS 1 1/4" / 1/2"	1.250	0.5000	1.417	2.362	1.772	0.157
○ R1931.14292	HS 1 1/4" / 9/16"	1.250	0.5625	1.417	2.362	1.811	0.157
● R1931.15882	HS 1 1/4" / 5/8"	1.250	0.6250	1.417	2.362	1.811	0.157
● R1931.17462	HS 1 1/4" / 11/16"	1.250	0.6875	1.417	2.362	1.890	0.157
● R1931.19052	HS 1 1/4" / 3/4"	1.250	0.7500	1.417	2.362	1.969	0.157
● R1931.25402	HS 1 1/4" / 1"	1.250	1.000	1.417	2.362	2.205	0.157
Reduction Sleeves HS 1 1/4"-CF							
● R1931.12703	HS 1 1/4"-CF / 1/2"	1.250	0.5000	1.417	2.362	1.772	0.157
● R1931.15883	HS 1 1/4"-CF / 5/8"	1.250	0.6250	1.417	2.362	1.811	0.157
● R1931.19053	HS 1 1/4"-CF / 3/4"	1.250	0.7500	1.417	2.362	1.969	0.157
● R1931.25403	HS 1 1/4"-CF / 1"	1.250	1.000	1.417	2.362	2.205	0.157

Reduction Sleeves mm to inch							
Part no.	Item description	D2 mm	D1 inch	D3 mm	L1 mm	L2 mm	L3 mm
Reduction Sleeves HS 12							
● R1912.03181	HS 12 / 1/8"	12	0.1250	16	40	29	4
● R1912.04761	HS 12 / 3/16"	12	0.1875	16	40	29	4
● R1912.06351	HS 12 / 1/4"	12	0.2500	16	40	29	4
● R1912.07941	HS 12 / 5/16"	12	0.3125	16	40	36	4
● R1912.09521	HS 12 / 3/8"	12	0.3750	16	40	37	4
Reduction Sleeves HS 20							
● R1920.03181	HS 20 / 1/8"	20	0.1250	25	50	28	4
● R1920.04761	HS 20 / 3/16"	20	0.1875	25	50	28	4
● R1920.06351	HS 20 / 1/4"	20	0.2500	25	50	36	4
● R1920.07941	HS 20 / 5/16"	20	0.3125	25	50	37	4
● R1920.09521	HS 20 / 3/8"	20	0.3750	25	50	36	4
● R1920.11111	HS 20 / 7/16"	20	0.4375	25	50	40	4
● R1920.12701	HS 20 / 1/2"	20	0.5000	25	50	45	4
● R1920.14291	HS 20 / 9/16"	20	0.5625	25	50	45	4
● R1920.15881	HS 20 / 5/8"	20	0.6250	25	50	48	4
Reduction Sleeves HS 25							
● R1925.03181	HS 25 / 1/8"	25	0.1250	30	56	29	4
○ R1925.04761	HS 25 / 3/16"	25	0.1875	30	56	29	4
● R1925.06351	HS 25 / 1/4"	25	0.2500	30	56	37	4
○ R1925.07941	HS 25 / 5/16"	25	0.3125	30	56	37	4
● R1925.09521	HS 25 / 3/8"	25	0.3750	30	56	38	4
○ R1925.11111	HS 25 / 7/16"	25	0.4375	30	56	40	4
● R1925.12701	HS 25 / 1/2"	25	0.5000	30	56	46	4
○ R1925.14291	HS 25 / 9/16"	25	0.5625	30	56	47	4
● R1925.15881	HS 25 / 5/8"	25	0.6250	30	56	48	4
● R1925.17461	HS 25 / 11/16"	25	0.6875	30	56	48	4
● R1925.19051	HS 25 / 3/4"	25	0.7500	30	56	48	4
○ R1925.20631	HS 25 / 13/16"	25	0.8125	30	56	50	4
Reduction Sleeves HS 32							
○ R1932.04761	HS 32 / 3/16"	32	0.1875	36	60	29	4
● R1932.06351	HS 32 / 1/4"	32	0.2500	36	60	36	4
○ R1932.07941	HS 32 / 5/16"	32	0.3125	36	60	36	4
● R1932.09521	HS 32 / 3/8"	32	0.3750	36	60	37	4
○ R1932.11111	HS 32 / 7/16"	32	0.4375	36	60	45	4
● R1932.12701	HS 32 / 1/2"	32	0.5000	36	60	45	4
○ R1932.14291	HS 32 / 9/16"	32	0.5625	36	60	46	4
● R1932.15881	HS 32 / 5/8"	32	0.6250	36	60	46	4
● R1932.17461	HS 32 / 11/16"	32	0.6875	36	60	48	4
● R1932.19051	HS 32 / 3/4"	32	0.7500	36	60	50	4
○ R1932.20631	HS 32 / 13/16"	32	0.8125	36	60	50	4
● R1932.22221	HS 32 / 7/8"	32	0.8750	36	60	50	4
○ R1932.23811	HS 32 / 15/16"	32	0.9375	36	60	52	4
● R1932.25401	HS 32 / 1"	32	1.000	36	60	56	4

# Reduction Sleeves

## mm to mm

Reduction Sleeves mm to mm							
Part no.	Item description	D2 mm	D1 mm	D3 mm	L1 mm	L2 mm	L3 mm
<b>Reduction Sleeves HS 12-MB (Micro Bore)</b>							
○ R1912.01009	HS 12-MB / 1 mm	12	1.000	16	40	20	4
○ R1912.01509	HS 12-MB / 1,5 mm	12	1.500	16	40	20	4
○ R1912.02009	HS 12-MB / 2 mm	12	2.000	16	40	20	4
○ R1912.02509	HS 12-MB / 2,5 mm	12	2.500	16	40	20	4
<b>Reduction Sleeves HS 12</b>							
● R1912.03000	HS 12 / 3 mm	12	3.000	16	40	29	4
● R1912.04000	HS 12 / 4 mm	12	4.000	16	40	29	4
● R1912.05000	HS 12 / 5 mm	12	5.000	16	40	29	4
● R1912.06000	HS 12 / 6 mm	12	6.000	16	40	36	4
● R1912.07000	HS 12 / 7 mm	12	7.000	16	40	37	4
● R1912.08000	HS 12 / 8 mm	12	8.000	16	40	37	4
● R1912.09000	HS 12 / 9 mm	12	9.000	16	40	37	4
● R1912.10000	HS 12 / 10 mm	12	10.000	16	40	40	4
<b>Reduction Sleeves HS 12-CF</b>							
● R1912.03002	HS 12-CF / 3 mm	12	3.000	16	40	29	4
● R1912.04002	HS 12-CF / 4 mm	12	4.000	16	40	29	4
● R1912.05002	HS 12-CF / 5 mm	12	5.000	16	40	29	4
● R1912.06002	HS 12-CF / 6 mm	12	6.000	16	40	36	4
● R1912.08002	HS 12-CF / 8 mm	12	8.000	16	40	37	4
<b>Reduction Sleeves HS 20</b>							
● R1920.03000	HS 20 / 3 mm	20	3.000	25	50	28	4
● R1920.04000	HS 20 / 4 mm	20	4.000	25	50	28	4
● R1920.05000	HS 20 / 5 mm	20	5.000	25	50	28	4
● R1920.06000	HS 20 / 6 mm	20	6.000	25	50	36	4
● R1920.07000	HS 20 / 7 mm	20	7.000	25	50	38	4
● R1920.08000	HS 20 / 8 mm	20	8.000	25	50	37	4
● R1920.09000	HS 20 / 9 mm	20	9.000	25	50	38	4
● R1920.10000	HS 20 / 10 mm	20	10.000	25	50	40	4
● R1920.11000	HS 20 / 11 mm	20	11.000	25	50	40	4
● R1920.12000	HS 20 / 12 mm	20	12.000	25	50	45	4
● R1920.13000	HS 20 / 13 mm	20	13.000	25	50	45	4
● R1920.14000	HS 20 / 14 mm	20	14.000	25	50	45	4
● R1920.15000	HS 20 / 15 mm	20	15.000	25	50	45	4
● R1920.16000	HS 20 / 16 mm	20	16.000	25	50	48	4
● R1920.18000	HS 20 / 18 mm	20	18.000	25	50	48	4
<b>Reduction Sleeves HS 20-CF</b>							
○ R1920.03002	HS 20-CF / 3 mm	20	3.000	25	50	28	4
● R1920.04002	HS 20-CF / 4 mm	20	4.000	25	50	28	4
● R1920.05002	HS 20-CF / 5 mm	20	5.000	25	50	28	4
● R1920.06002	HS 20-CF / 6 mm	20	6.000	25	50	36	4
● R1920.08002	HS 20-CF / 8 mm	20	8.000	25	50	37	4
● R1920.10002	HS 20-CF / 10 mm	20	10.000	25	50	40	4
● R1920.12002	HS 20-CF / 12 mm	20	12.000	25	50	45	4
● R1920.14002	HS 20-CF / 14 mm	20	14.000	25	50	45	4
● R1920.16002	S 20-CF / 16 mm	20	16.000	25	50	48	4

Reduction Sleeves mm to mm							
Part no.	Item description	D2 mm	D1 mm	D3 mm	L1 mm	L2 mm	L3 mm
<b>Reduction Sleeves HS 25</b>							
● R1925.03000	HS 25 / 3 mm	25	3.000	30	56	29	4
● R1925.04000	HS 25 / 4 mm	25	4.000	30	56	29	4
● R1925.05000	HS 25 / 5 mm	25	5.000	30	56	29	4
● R1925.06000	HS 25 / 6 mm	25	6.000	30	56	37	4
● R1925.07000	HS 25 / 7 mm	25	7.000	30	56	37	4
● R1925.08000	HS 25 / 8 mm	25	8.000	30	56	37	4
● R1925.09000	HS 25 / 9 mm	25	9.000	30	56	38	4
● R1925.10000	HS 25 / 10 mm	25	10.000	30	56	40	4
● R1925.12000	HS 25 / 12 mm	25	12.000	30	56	46	4
● R1925.14000	HS 25 / 14 mm	25	14.000	30	56	47	4
● R1925.16000	HS 25 / 16 mm	25	16.000	30	56	48	4
● R1925.18000	HS 25 / 18 mm	25	18.000	30	56	48	4
● R1925.20000	HS 25 / 20 mm	25	20.000	30	56	50	4
<b>Reduction Sleeves HS 32</b>							
○ R1932.03000	HS 32 / 3 mm	32	3.000	36	60	29	4
○ R1932.04000	HS 32 / 4 mm	32	4.000	36	60	29	4
○ R1932.05000	HS 32 / 5 mm	32	5.000	36	60	29	4
● R1932.06000	HS 32 / 6 mm	32	6.000	36	60	36	4
● R1932.07000	HS 32 / 7 mm	32	7.000	36	60	37	4
● R1932.08000	HS 32 / 8 mm	32	8.000	36	60	36	4
● R1932.09000	HS 32 / 9 mm	32	9.000	36	60	37	4
● R1932.10000	HS 32 / 10 mm	32	10.000	36	60	40	4
○ R1932.11000	HS 32 / 11 mm	32	11.000	36	60	40	4
● R1932.12000	HS 32 / 12 mm	32	12.000	36	60	45	4
● R1932.13000	HS 32 / 13 mm	32	13.000	36	60	45	4
● R1932.14000	HS 32 / 14 mm	32	14.000	36	60	46	4
○ R1932.15000	HS 32 / 15 mm	32	15.000	36	60	46	4
● R1932.16000	HS 32 / 16 mm	32	16.000	36	60	48	4
○ R1932.17000	HS 32 / 17 mm	32	17.000	36	60	48	4
● R1932.18000	HS 32 / 18 mm	32	18.000	36	60	49	4
○ R1932.19000	HS 32 / 19 mm	32	19.000	36	60	49	4
● R1932.20000	HS 32 / 20 mm	32	20.000	36	60	50	4
● R1932.22000	HS 32 / 22 mm	32	22.000	36	60	50	4
● R1932.25000	HS 32 / 25 mm	32	25.000	36	60	56	4
<b>Reduction Sleeves HS 32-CF</b>							
○ R1932.06002	HS 32-CF / 6 mm	32	6.000	36	60	36	4
○ R1932.08002	HS 32-CF / 8 mm	32	8.000	36	60	36	4
○ R1932.10002	HS 32-CF / 10 mm	32	10.000	36	60	40	4
○ R1932.12002	HS 32-CF / 12 mm	32	12.000	36	60	45	4
○ R1932.14002	HS 32-CF / 14 mm	32	14.000	36	60	46	4
○ R1932.16002	HS 32-CF / 16 mm	32	16.000	36	60	48	4
○ R1932.18002	HS 32-CF / 18 mm	32	18.000	36	60	49	4
○ R1932.20002	HS 32-CF / 20 mm	32	20.000	36	60	50	4
○ R1932.25002	HS 32-CF / 25 mm	32	25.000	36	60	56	4

# Accessories

## Torque wrench and Extractor



### Comparison of Transmittable Torque at Ø 20 mm

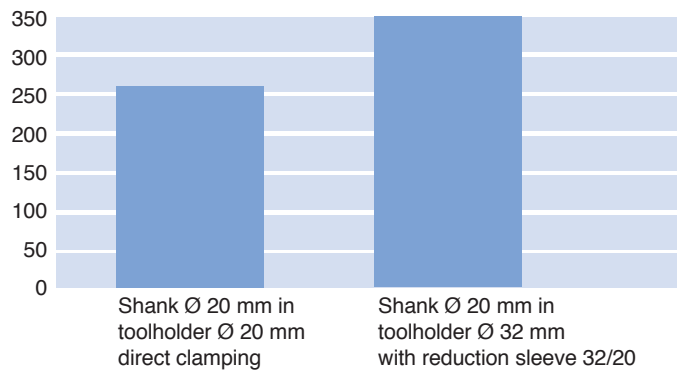

### Torque wrench

Use torque wrench to ensure correct tightening independent on user. Should be used with all HYDRO-FIX® holders.

Item description	Tightening torque:		Part no.
	Nm	ft · lb	
• Torque wrench (4 mm Hex)	6	4.4	19055
• Torque wrench (5 mm Hex)	6	4.4	19050
• Torque wrench (8 mm Hex)	10	7.4	19054

### Extractor

Item description	Part no.	For Sizes	A B	
			[mm]	[mm]
• EHS 12 - 1/2"	E7321.12000	HS 12	24.6	100
• EHS 20 - 3/4"	E7321.20000	HS 20	38.0	160
• EHS 25 - 1"	E7321.25000	HS 25	51.0	180
• EHS 32 - 1 1/4"	E7321.32000	HS 32	63.0	200

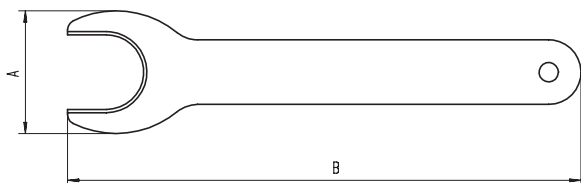

The extractor helps to remove the reduction sleeve from the clamping unit.

- Improper assembly can damage the concentricity of the reduction sleeve.
- Insert tools the full length of the reduction sleeve.
- Tool shank h6 or h7 can be used.
- Do not clamp reduction sleeve without a tool. Reduction Sleeve will be damaged.

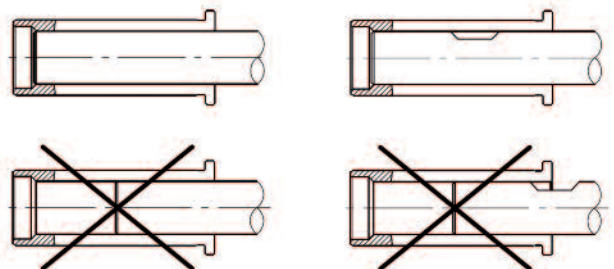

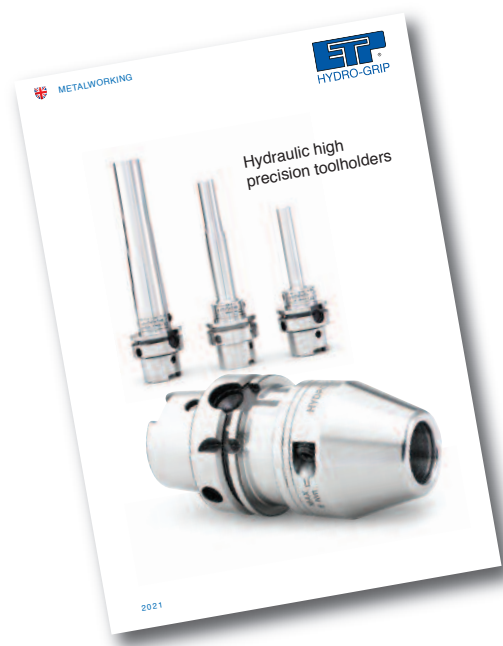

*More Hydraulic high  
precision toolholders  
- see our main catalogue*



*Examples: Holders for rotary transfer machines*

ETP HYDRO-GRIP®  
HSK Form C - DIN 69893



ETP HYDRO-GRIP®  
HSK Form C - For HYDROMAT®



Box 1120, SE-581 11 Linköping, Sweden  
Tel. +46 (0)13 24 71 00  
E-mail: info@etp.se, Internet: www.etp.se