



Tailored to your manufacturing
MAPAL SERVICES





"These days our customers cannot afford a stoppage, either in production or in the optimisation of their processes. However, introducing additional new processes during on-going production is scarcely feasible using internal capacity. We therefore support our customers in relation to their needs in the area of tool and process solutions".



Dr. Jochen Kress, member of the senior management at MAPAL Dr. Kress KG



CONTENTS

01 MAPAL as technology partner

Individualised support	04
------------------------------	----

02 Engineering

Introduction	06
Overview	08
Modules	10
TET service package	14
re.tooling service package	16
Technology centre	18

03 Logistics

Introduction	20
Overview	22
Modules	24
In practice: Tool logistics	28
In practice: Tool management	30

04 Maintenance

Introduction	32
Overview	34
Reconditioning, optimisation and repair	36
Maintenance and inspection	38
Worldwide service centres	40

05 Training

Introduction	42
Overview	44
Training and further training	46
Technology, sector and part seminars	48
Customer-specific seminars	50
Organisation	51

INDIVIDUALISED SUPPORT TO SUIT YOUR NEEDS EXACTLY

In the metal-machining industry, the focus is on process costs. Anybody who wants to control them must understand all processes. Here it is good if businesses can rely on a technology partner who offers comprehensive support from planning to the series production process.

MAPAL's roots lie in the manufacture of custom tools. For this reason we have always focussed on holistic advice and support for machining tasks and processes.

We support you in all phases and all areas of production with our services. Irrespective of whether you are setting up a new production facility, optimising your processes, introducing new technologies, re-tooling your machines for new parts, optimising your tool inventory, or want to expand the know-how of your employees.



STRAIGHT TO PROCESSES OPTIMISED FOR YOU:

SERVICES CAN BE SELECTED INDIVIDUALLY

You can either combine the individual service modules to suit your needs, or request services in the form of pre-defined service packages. You always receive exactly the support you need.

EVERYTHING FROM A SINGLE SOURCE

At MAPAL you receive everything from a single source and profit from the tools and process competence of a specialist. You save time and costs for co-ordination and can be certain that all solutions are perfectly harmonised.

ON-SITE SERVICES AROUND THE WORLD

Thanks to sites worldwide we can get to you quickly, anywhere. Our engineering experts go straight to your production; upon request our logistic specialists take over your complete tool management on-site.

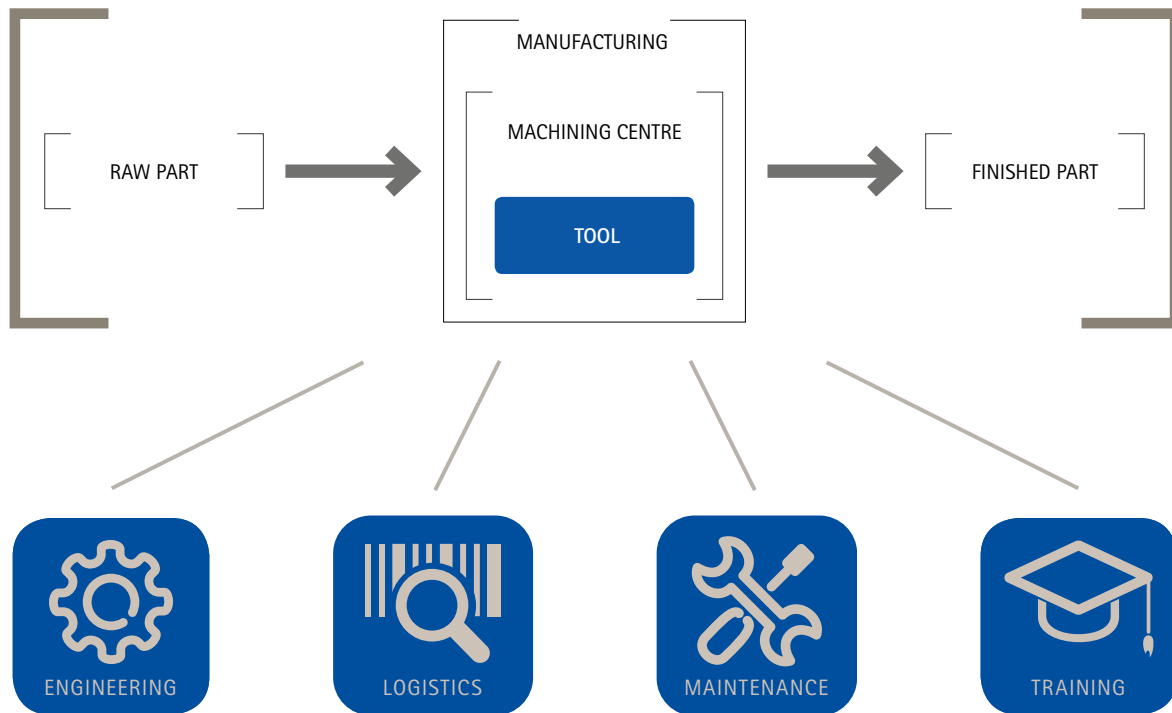

■ CUSTOMER ■ MAPAL

With our engineering services, we ensure that you manufacture quickly, precisely and reliably. We tap further potential for savings for you in the logistics and maintenance area. And in the training area we pass on to you our accumulated specialist know-how – so that you obtain that crucial lead over your competitors.

Irrespective of the degree to which you make use of our services, we ensure processes are optimal and accompany you on your way to Industry 4.0. Our objective: that you manufacture more smoothly, more productively and more cost-effectively.

MANUFACTURING COSTS IN DETAIL

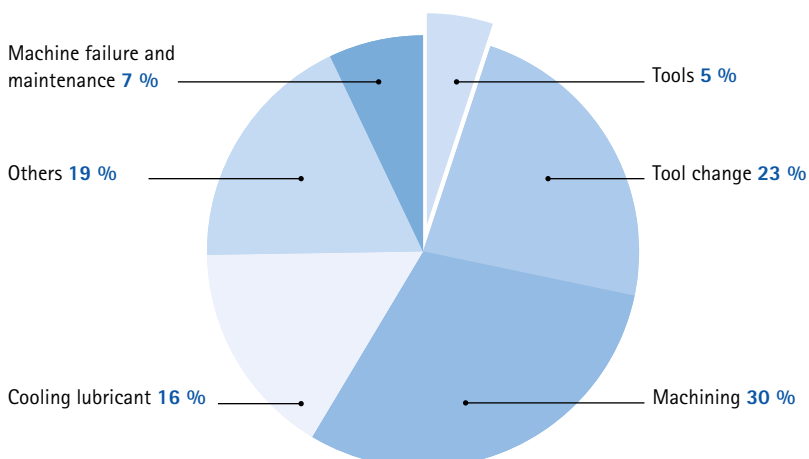

THE MAPAL EFFECT

POSITIVE IMPACT ON MANUFACTURING COSTS

The direct tool costs only make up approx. 5 % of your manufacturing costs. With MAPAL services you improve all the processes related to the tool and can have a positive impact on your total manufacturing costs.



TECHNICAL LEAD DIRECTLY ONSITE IN YOUR FACILITY

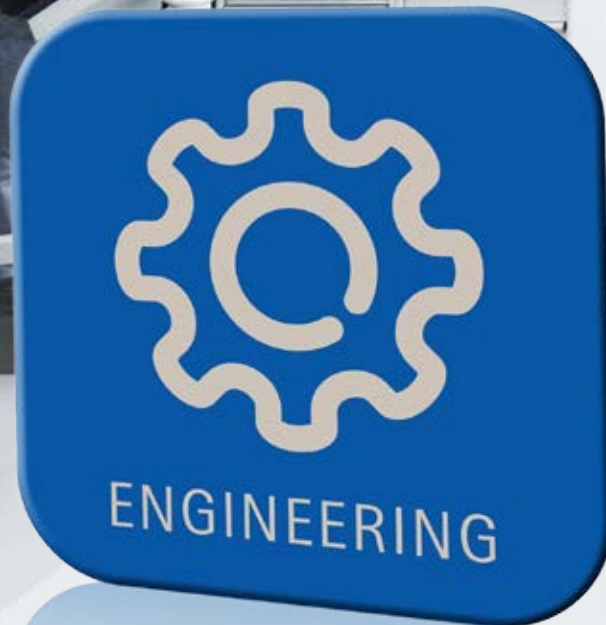

Irrespective of whether you need a tailor-made custom tool or want to commission us to design a complete process: we guarantee reliable processes and create that crucial technological lead for you.

Our Technology Expert Teams (TET) are familiar with the latest machining strategies and are specialists for the development of innovative tool solutions. We support you worldwide on-site and work closely with your staff. As it is our intention that you should be able to rely on optimal processes in every respect.



100

TECHNOLOGY EXPERTS

Our Technology Expert Teams (TET) comprises of engineers who, with their long-term experience, have specialised in planning projects for specific parts. Based on this know-how you receive innovative, reliable solutions quickly and directly.



INVEST IN PROGRESS

As an engineering partner, we accompany you from the planning to the optimisation of your production. You can select from our service modules as required, or make use of service packages specially tailored to your needs.

In both cases you profit from our high level of innovative and our holistic perspective of your process. Our engineering experts have many years of experience in a very wide range of sectors. Our technology centre is equipped with the latest equipment, as such we are able to simulate every production process exactly and during this process we are able to find new, even better solutions.

We have driven forward modern processes, e.g. minimum quantity lubrication, with innovative tool solutions. We are also very familiar with the machining of the modern materials. Furthermore, we are continually testing possible applications for new processes, e.g. 3D printing. Here we receive stimuli from our partnership-based collaboration with users, machine and material manufacturers, as well as colleges and universities.



YOUR INITIAL SITUATION

YOU WANT TO RE-DESIGN A MANUFACTURING PROCESS

Concentrate on your core competence. We take over the project planning for your complete workpieces and plan and realise a reliable process – quickly, flexibly, on-site, with transparent costs and complete documentation.

YOU WANT TO RE-TOOL YOUR MANUFACTURING FOR NEW PARTS?

Continuing to use existing machines saves time and costs. With our know-how we guarantee the highest process reliability. We support you individually according to your needs and, upon request, take over the complete responsibility for your re-tooling.

YOU WANT TO OPTIMISE YOUR TOOLS AND PROCESSES?

You want to introduce modern machining strategies and innovative tool solutions during on-going production? We take over this task for you. The result: longer tool lives, improved part quality and increased productivity.

OUR ENGINEERING SERVICES: CAN BE COMBINED INDIVIDUALLY

E1

PROJECT ANALYSIS

E2

PROCESS DESIGN

E3

TOOL SOLUTIONS

E4CUSTOMER-SPECIFIC
DOCUMENTATION**E5**

FIXTURE SOLUTIONS

E6TOOL RESTRICTION
STUDY**E7**

NC PROGRAMMING

E8BREAKING-IN &
COMMISSIONING**E9**

START-UP SUPPORT

SERVICES PROVIDED BY THE MAPAL TECHNOLOGY CENTRE

PROCESS VALIDATION
AND ASSURANCEENDURANCE TESTS
FOR TOOLS TO CHECK
THE PROCESS
RELIABILITYPRE-PRODUCTION
WITH INITIAL
SAMPLINGMANUFACTURE OF
NEAR SERIES
PRODUCTION
PROTOTYPES



ENGINEERING SERVICE MODULES E1 – E6

Our Technology Expert Teams implement your project quickly, flexibly and as per your requirements. From the start we do not place the emphasis on isolated tool costs, but on the complete process.

It also pays off to transfer the complete process responsibility to MAPAL in relation to the technology. We can then perfectly match all components, optimally design the fixture and in this way fully exploit the performance of our innovative tools. To extract the full potential from the tool and machine, we also work closely with machine manufacturers.

E1



PROJECT ANALYSIS

Based on raw part and finished part drawings as well as machine data, in close collaboration with you we analyse the manufacturing task and develop effective machining strategies for all steps.

- Machining proposals for all machining steps
- Tool list
- Tool sketches
- Feasibility study
- Harmonisation with the machine situation
- Preparation of bore and surface plans

E2



PROCESS DESIGN

Irrespective of whether the focus is on flexibility or productivity: by means of the sound design of your machining process, we support you on the way to stable, economic manufacturing.

- Cycle time studies
- Definition of technology data
- Division of process over individual machines
- Clamping principle sketches

E3



TOOL SOLUTIONS

Outstanding performance, simple handling, cost-effective reconditioning: we specifically select the best, latest, cost-effective tools for your application, or we develop them.

- Tool design
- Tool engineering
- Combination tools for reducing process steps
- Design of clamping technology
- Tool drawings
- Assembly, setting and balancing (at MAPAL)
- Delivery to the place of use
- Professional support during breaking-in



E4



DOCUMENTATION

Upon request we adapt the documentation prepared as part of our services specifically to your requirements. This ensures the rapid implementation of the new processes and makes future changes easier.

- Setting plans
- Tool plans
- Setting and installation instructions
- Work instructions
- Inspection and measurement logs/reports
- Trials logs
- Process capability reports

E5



FIXTURE SOLUTIONS

With individual solutions we ensure that as many workpieces and as many machining steps as possible can be reliably machined with μ -precision in one clamping system.

- Preparation of drafts
- Engineering
- Manufacture/buying-in
- Assembly and commissioning
- Technical support
- Pre-acceptance with clamping trial

E6



TOOL RESTRICTION STUDY

To prevent collisions and to identify optimisation potential, based on 3D models we simulate your planned machining process in advance in a virtual environment.

- Collision analyses
- 3D study
- Optimal harmonisation of tools to fixture, workpiece and machine compartment
- Prerequisite: virtual models of tools, workpiece, clamping fixture and machine



ENGINEERING SERVICE MODULES

E7 — E9

Our engineering support ranges from process planning to the start-up of your production. Here for all the services selected, you have a central point of contact who co-ordinates the collaboration with your staff.

During the implementation phase, we again specifically ensure that you manufacture as productively and economically as possible. Here the holistic perspective of your processes pays off, a perspective we then have, in particular, if we support your project from the start. When the process is finally transferred to the responsibility of your staff, we train them in detail to ensure a smooth process also in future.



NC PROGRAMMING

To design your process so it is as productive as possible, we optimise the machining parameters during NC programming. In this way secondary activities such as loading/unloading and tool change can be accelerated.

- Preparation of NC program taking into account manufacturer-specific machine functions
- Preparation of special milling cycles (e.g. interpolation turning, trochoidal milling)
- Computer-based generation of machining contours (2D/3D)
- Customer-specific program structure

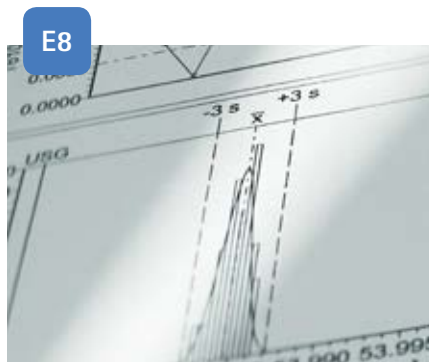

BREAKING-IN & COMMISSIONING

So that you produce reliably and without scrap, we take over the commissioning and the breaking-in of your process on-site. If the schedule is tight, breaking-in can also be undertaken in our technology centre.

- Checking and logging the machine geometry
- Installation of NC technology
- Breaking-in the complete machining process
- Preparation and implementation of process capability study
- Transfer of process to the customer



START-UP SUPPORT

We also support you on-site as your production starts up. So that you can manufacture as productively and economically as possible, our specialists continuously check the tool lives and cutting data for the tools.

- Support for production start-up
- Troubleshooting
- Technical support
- Training on operation, programming and process sequence



YOUR ADVANTAGES

- Solutions for complete workpieces from experienced specialists
- Complete process design and implementation from a single source
- Latest manufacturing methods
- Efficient, cost-optimised tool technology
- Optimal harmonisation of tool, workpiece, fixture and machine
- Highest product quality, process reliability and cost-effectiveness from the start
- Quick transition from planning to implementation with completely dependable planning



SOLUTIONS FOR COMPLETE WORKPIECES TET SERVICE PACKAGE

E1

E2

E3

E4

The Technology Expert Team (TET) service package as a rule encompasses the engineering modules 1–4. With TET we take over the project planning for complete workpieces. You profit specifically from our engineering experience.



CYCLE TIME REDUCED BY 60 %
TOOL LIFE INCREASED BY 40 %

INTERPOLATION TURNING TOOL

AN EXAMPLE OF SUCCESS

Turbochargers are complex systems that compensate for the power lost due to the reduced engine capacity of downsized engines. To obtain optimal efficiencies they must be manufactured extremely precisely.

As part of a TET project, MAPAL has developed an extremely cost-effective method for the complete machining of turbocharger components. This method makes it possible, for instance, to machine all the features for the main bore in the turbine housing in only four steps. Here ISO tools with tangential technology are used and in this way as many machining steps as possible combined. During the pre-machining and semi-finishing machining, for example, a total of six machining features and a control cut are made using only one tool.

MAPAL has also developed a particularly cost-effective process for the contour of the recess for the V-band connection on the turbine housing. While conventional machining using multiple cutting edge chamfering milling cutters, as a rule, results in long machining times with only moderate tool lives, MAPAL has been able to reduce the cycle time from 55 to 35 seconds and increase the tool life by up to 40%. The change to interpolation turning tools with shaped inserts and continuous cut made this possible.

For the fine machining of turbine and compressor housings, often a lathe is used in addition during the conventional machining process. MAPAL has replaced this time-consuming and expensive manufacturing process with the mechatronic actuating tool TOOLTRONIC® – a fully-fledged interchangeable tool axis that makes it possible to machine any contours or recesses and that is regulated using the machine control system.

To keep the total weight of the complete turbocharger low, the compressor housing is cast in aluminium alloys. The housing is predestined for the use of MAPAL PCD tools. For machining the main bore, MAPAL has developed a combination tool that combines the recessing, fine boring and countersinking machining steps. As a consequence in total only eleven tools are needed to completely machine the compressor housing.

6 MACHINING FEATURES

1 REFERENCE BLANK

ISO COMBINATION TOOL

LATHE SAVED
INTERCHANGEABLE TOOL AXIS

TOOLTRONIC®



YOUR ADVANTAGES

- Solutions for complete workpieces from experienced specialists
- Innovative machining process
- Latest tool technology
- Optimal machining results and machining times due to individual tool solutions (e.g. combination tools)
- Reliable, competitive manufacturing process
- Quick and flexible support on-site
- Complete documentation included



The part to be machined:
a turbocharger.



PROCESS DESIGN AND IMPLEMENTATION FROM A SINGLE SOURCE RE.TOOLING SERVICE PACKAGE

E1

E2

E3

E4

E5

E6

E7

E8

E9

For initial equipping or re-tooling existing machinery, we offer the re.tooling service package. As a rule this package comprises of the modules 1–9, however it can be specifically adapted to your needs.



AN EXAMPLE OF SUCCESS

MAPAL tools are used successfully worldwide for machining aluminium steering rack tubes. In particular, MAPAL PCD tools have proven themselves in the series production manufacture of these parts.

For a time-critical project related to the manufacture of steering rack tubes, a customer transferred the complete process responsibility to MAPAL. On the one hand the customer did not have the resources to be able to tackle such a project on schedule. On the other hand the customer also wanted to profit specifically from the experience of the tool and process specialists at MAPAL.

The MAPAL team undertook a cycle time study and drafted a clamping concept which allowed the complete part to be manufactured in one clamping system on a 5-axis machining centre. After the definition of the most cost-effective tools and a detailed collision assessment, MAPAL manufactured the tools and the clamping fixture parallel. To this MAPAL staff prepared the NC program for the machine controller.

MAPAL also undertook the complete installation of the process and the adaptation of the NC program. For this purpose, MAPAL staff worked on-site at the customer at the machine. After successful installation, MAPAL transferred the process to the customer on schedule. And despite the tight schedule, the customer profited from a process implemented with extremely high quality that, from then on, made possible particularly cost-effective manufacture.

COMPLETE EXTERNAL
CONTOUR ON ONE TOOL
ACCURATE MACHINING

PCD CIRCULAR MILLING TOOL

REVERSE MACHINING SPINDLE
INSERT
HIGH-ACCURACY MACHINING
WITHOUT CHANGEOVER ERROR

PCD BORING TOOL

HEAVY METAL CORE FOR
VIBRATION-FREE MACHINING
BEST SURFACE FINISH

PCD BORING TOOL

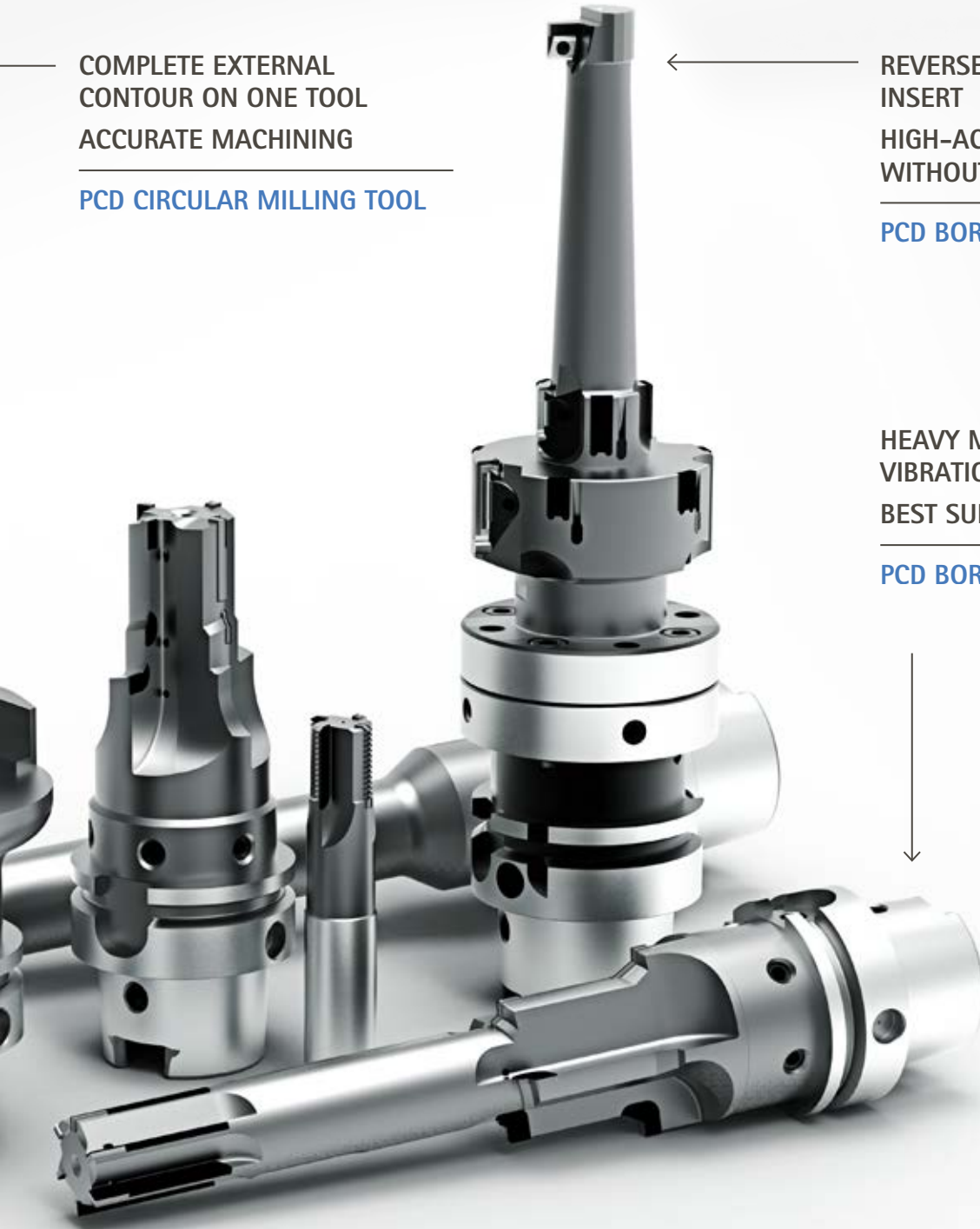

YOUR ADVANTAGES

- Cost-effective manufacturing without investing in new machines
- Solutions for complete workpieces including tools, fixtures, NC program and commissioning
- Process planning and implementation from a single source by experienced specialists
- Usage of the latest machining technology and efficient, cost-optimised tools
- Quick and flexible support on-site
- High-quality implementation also with tight schedules



The part to be machined:
a steering rack tube.

MAPAL TECHNOLOGY CENTRE: THE CRADLE FOR ADVANCED TECHNOLOGIES

Simulating, testing and breaking-in processes without tying up your own capacity, for this purpose the MAPAL technology centre offers you a real manufacturing environment with 11 modern machining centres, grinding machine and high-precision measuring systems, as well as the possibility of additive manufacture (3D printing). 50 engineers and technicians support and accompany you from the idea to implementation on your premises.

SERVICES PROVIDED BY THE TECHNOLOGY CENTRE:

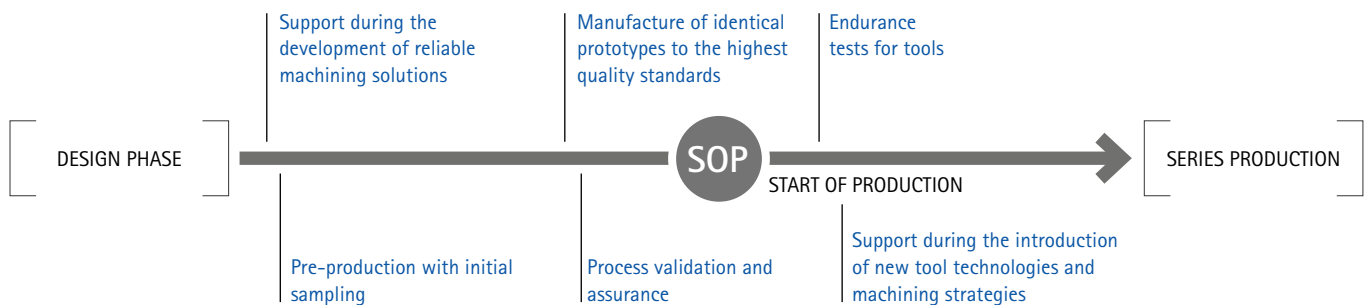

ALWAYS ONE STEP AHEAD

Our goal is to apply the latest findings from research for you in practice to make your manufacturing even more efficient. For this purpose we co-operate with universities and leading research institutes and are in close contact with machine manufacturers. With more than 410 trial series per year, the MAPAL technology centre is the cradle for advanced technologies.

LEADING SOLUTIONS

We offer you reliable solutions for your part based on the latest machining strategies and production processes, for instance minimum quantity lubrication (MQL) or additive manufacturing (3D printing). For your machining task our engineers specifically develop tool solutions that are perfectly adapted to the material to be machined.

FOCUS ON PROCESS COSTS

Crucial for the productivity of your process is the cycle time. By using combination tools we reduce the number of process steps. In addition, we determine the maximum machining values for your machining process. An increase in the cutting speed of 20 % can reduce the costs per part by as much as 15 %.



TECHNOLOGY HIGHLIGHTS:

IMPROVED CYCLE TIME
MINIMISED SETTING EFFORT

MULTI-BLADED PCD FINE BORING TOOL FOR
MACHINING VALVE BORES



PREVENTS DELAMINATION AND FIBRE PROTRUSION
LONGER TOOL LIFE

DIAMOND-COATED MILLING CUTTER FOR
MACHINING FIBRE COMPOSITE MATERIALS



75 % REDUCED MACHINING TIME DUE TO
ONE-SHOT SOLUTION

OPTIMAL EMBEDDED PCD BLADES

SPIRALLED PCD STEP DRILL



55 % WEIGHT SAVING DUE TO ADDITIVE
MANUFACTURING

SHORTER MACHINING TIME

WEIGHT-OPTIMISED EXTERNAL REAMER





FINANCIAL SCOPE EVERYWHERE IN YOUR TOOL INVENTORY



Too many tools in the store signify unnecessary costs. Not enough will result in production stoppage. There is therefore significant potential for savings both in your tool inventory and in the tool management process.

Our logistics experts will help you to tap all the available financial scope. Depending on your needs, we initially ensure that information on your tool inventory can be retrieved transparently and at any time. As controlling your tools is the basis for efficient tool management.



48 %

SAVING PER PART

For a special engine manufacturing process, the costs per part were reduced by 48% in 14 months with the aid of the logistics experts from MAPAL. And that even though the volume produced per day increased from 65 to 130 in the same period.



INVEST IN TOOL CONTROL

Our range of logistics services ranges from the analysis of the tool inventory with suggestions for optimisation, to complete tool management by MAPAL. Here you can select individual service modules or a complete service package.

Irrespective of the services you purchase from us, in any case you will profit from our tool competence, free up capacity in your production and will therefore be able to concentrate specifically on your core business. As a long-term technology partner we continuously optimise your processes related to the tool and in this way increase your productivity.

Depending on the size of your production and the way it is organised, the parts produced and the tool consumption, we prepare an individual, cost-optimised logistics concept. Our possibilities range from a single service to full service. Here the latter signifies that MAPAL staff on-site on your premises completely take over the procurement, assembly, disassembly and pre-setting of the tools.



YOUR INITIAL SITUATION

YOU WANT TO ORGANISE YOUR TOOL INVENTORY CLEARLY

We ensure the clear organisation and optimisation of your tool inventory based on transparent data. In this way you avoid unnecessary machine stoppages and unnecessary capital commitment.

YOU WANT TO OPTIMISE YOUR INVENTORY CONTINUOUSLY

Upon request a MAPAL specialist is also available on-site who provides long-term support and implements continuous measures for the optimisation of your tool costs.

YOU WANT TO OUTSOURCE YOUR TOOL MANAGEMENT

In this case MAPAL staff take over the complete procurement and management of the tools in your organisation, including all tasks in the setting room.

OUR LOGISTICS SERVICES: CAN BE COMBINED INDIVIDUALLY

L1

INVENTORY ANALYSIS

L2

CATALOGUING

L3

PROCUREMENT
MANAGEMENT

L4

RECONDITIONING

L5

PICK-UP SERVICE

L6

TOOL DISPENSING
SYSTEM

L7

PLANNING

L8

STOCK MANAGEMENT

L9

ANALYSIS &
OPTIMISATION

L10

TECHNICAL SUPPORT

L11

PLANNING THE
SETTING ROOM

L12

ASSEMBLY & SETTING

OUR BILLING OPTIONS

AFTER WITHDRAWAL

With this billing model you receive one invoice with all the tools used at the end of the month. The effort for your procurement and your financial bookkeeping is reduced significantly as a result.

SHARP CUTTING EDGE

The price for the tools used is calculated here as a mixture of the new price, re-grind price and number of times reconditioning is possible. This means predictable, constant tool costs.

COST PER PART

You remain particularly flexible and are guaranteed annual savings. With this model the tool costs per part produced are calculated. This option ensures optimal cost distribution with fluctuating volumes.



LOGISTICS SERVICE MODULES L1 – L6

Do your machine operators spend unnecessary time looking for tools? Is part of your inventory never used? And are you not able to deliver some orders on time because the necessary tools are not in stock?

With MAPAL as your logistics partner, you will be able to answer all these questions with "no". We analyse and optimise your inventory in relation to costs and organisation, and ensure that your staff always find the right tool in the right place. The basis for this service is a transparent pool of data that can be retrieved at any time, an intelligent tool dispensing system, a purged list of suppliers and the perfect reconditioning of your tools.

L1



INVENTORY ANALYSIS

To determine your needs, our experts initially analyse your tool inventory and your tool management, and based on this analysis prepare a quotation for the optimisation.

- Analysis of the actual inventory situation
- Proposal for optimisation
- MAPAL expert team on-site

L2



CATALOGUING

By cataloguing your tool inventory, we create a uniform, permanently retrievable pool of data. This pool of data acts as the basis for the clear organisation of your tools.

- Consistent master data
- Preparation of tool drawings and setting sheets
- Preparation of planning data (minimum, maximum, re-order stock levels)

L3



PROCUREMENT MANAGEMENT

Also important for the clear organisation of your tool inventory is optimised procurement management. We take over the responsibility for this aspect and reduce the load on your staff.

- Processing of MAPAL articles
- Optional procurement of articles from other manufacturers
- Supplier purging



RECONDITIONING

You can save costs by reconditioning your tools to original quality in good time. We offer a complete service for all types of tools.

- Reconditioning of own tools and tools from other manufacturers
- Inspection & maintenance of actuating tools, setting and measuring devices
- Repair service



PICK-UP SERVICE

To ensure quick and reliable processing during reconditioning, we pick up the tools from your premises and then return them back to you freight paid.

- Collection by service driver or courier
- Safe transport in the MAPAL toolbox
- Delivery of reconditioned tools



TOOL DISPENSING SYSTEM

With our tool dispensing system you can continuously monitor your tool inventory electronically. We install the system and, if required, train your staff.

- Automatic tool dispensing
- Intuitive software
- Variable drawer division
- Simple order processing



LOGISTICS SERVICE MODULES L7 – L12

The clear, transparent, cost-optimised organisation of your tool inventory (service modules L1–L6) is only the first step on the way to maximum cost-effectiveness. With our service modules L7–L12 we offer you further possibilities.

Here you profit from an expanded view of the interaction of all processes related to the tool and in production. By adapting the tool inventory to the volume produced, by holistically optimising the machining process and by professionally setting your tools, we tap further potential for you to make savings.

L7



PLANNING

With our planning service we adapt the tool inventory exactly to your orders and the volumes produced. In this way you work particularly cost-effectively.

- Inventory management
- Consideration of changes in production volumes
- Continuous maintenance of planning data (minimum, maximum, re-order stock levels)

L8



STOCK MANAGEMENT

Upon request, we also take over the complete management of your stock including purging and identifying slow/non-moving articles.

- Stock purging
- Identification of slow/non-moving articles
- Consignment store

L9



ANALYSIS & OPTIMISATION

Anybody who wants to realise savings in the area of tool costs must take into account the complete machining process. Here you profit from our process competence.

- Tool costs per machine
- Tool costs per part
- Analysis of reasons for withdrawal and tool fractures
- Joint definition of optimisation objectives
- Holistic optimisation of the machining process



L10



TECHNICAL SUPPORT

As part of this service you receive long-term support from a MAPAL specialist who implements, on-site, continuous measures for the optimisation of your tool costs.

- Technical contact on-site
- Troubleshooting

L11



PLANNING THE SETTING ROOM

You also profit from our experience as a tool specialist during the planning of your setting room. Here we create the basis for precise, cost-effective manufacturing.

- Planning and implementation of the setting room

L12



ASSEMBLY & SETTING

Upon request MAPAL staff also undertake the assembly and setting of your tools on your premises over the long term.

- Disassembly and assembly of the tools
- Precision setting of the tools to drawing by MAPAL personnel
- Maintenance of the tool body



LOGISTICS IN PRACTICE: TOOL LOGISTICS

Our individually selectable logistics support ranges from the one-off optimisation of your inventory to taking over your tool management entirely. In the following example the responsibility for tool procurement lay entirely with MAPAL.

The customer's goal in this case was to reduce tool costs sustainably by means of the clear organisation and optimisation of the inventory, and at the same time to make the tool costs predictable and flexible. With the outsourcing of the tool procurement, the customer was also able to concentrate on his core competence.

Specifically, the customer used the MAPAL logistics service modules 1–8. The project covered all tools for the parts: ABS housing, brake mounting and brake caliper. To make the tool inventory controllable and transparent, MAPAL used three UNIBASE-M tool cabinets with integrated data acquisition. Parallel to this, the MAPAL team set up a consignment store. This store ensured that the tool inventory at the customer was always kept as low as possible and in this way it was possible to avoid unnecessary cost commitment. The monthly billing for the tools per cutting edge and the reports prepared by MAPAL also ensured the best possible predictability.

The complete responsibility for the procurement, goods receipt inspection and storage of all tools (including articles from other manufacturers) as well as for the reconditioning by an external service was now with MAPAL. In addition, MAPAL supplied and filled the dispensing systems at the customer. By means of the continuous exchange of information, it was possible to continuously optimise the inventory. The customer always had a competent contact person available on-site who ensured the processes ran smoothly.

"Thanks to MAPAL, today we profit from the maximum availability of the necessary tools while maintaining maximum control of the tool costs at the same time. We were able to significantly reduce processes that did not add value and in this way sustainably increase the efficiency of our production", concludes the customer.

THE PROJECT AT A GLANCE

MAPAL TASKS:

- Setting up a consignment store
- Management and planning
- Withdrawal of blunt tools and placing new tools in store
- Pick-up of used tools and delivery of new tools

CUSTOMER TASKS:

- Withdrawal of new/reconditioned tools
- Placing blunt tools in store
- Assembly, disassembly and setting of the tools



LOGISTICS IN PRACTICE: TOOL MANAGEMENT

Beyond procurement, upon request MAPAL takes over all other tasks related to your tools. Based on our many years of tools and process experience, we achieve notable successes for you during these tasks.

In one example, a customer transferred the responsibility for the complete tool management to MAPAL. The customer's goal was to reduce as far as possible the tool costs, and also the value of the inventory and the costs per part, and in this way to significantly increase the efficiency of his production. To further increase productivity, the cycle time was also to be reduced. Here MAPAL's combined tool and process experience paid off particularly well.

In this case the customer used the complete logistics service modules 1–12. Specifically, the tools were for cylinder head and engine block parts. Ten UNIBASE-M tool dispensing cabinets were in use, there was also a tool manager and a tool logistics specialist from MAPAL, who took over the responsibility for the entire process chain on-site at the customer. Thanks to the full service from MAPAL from a single source, it was possible to exploit the greatest possible optimisation potential.

The experts from MAPAL initially analysed the complete manufacturing and machining process and optimised, independently of the supplier, the tools and the setting room based on the results. During this process they took into account the optimal tool flow, and also the existing equipment. The tasks undertaken by MAPAL also included the training of the customer's staff on how to handle the tools correctly.

The cost per part billing model ensured that the customer had controlled, adapted tool costs, even with fluctuating production volumes. And the continuous analysis and optimisation of the machining process by MAPAL experts on-site paid off massively: Within six years the customer achieved minimum costs with maximum volume, with a total reduction in the tool costs of 60%.

THE PROJECT AT A GLANCE

TASKS, MAPAL TOOL MANAGER:

- First point of contact for the customer
- Reporting and controlling
- Inventory and cost control for all tools
- Supplier-independent tool optimisation
- Material management and planning for all wearing parts

TASKS, MAPAL TOOL LOGISTICS SPECIALIST:

- Ordering and procurement of all wearing parts
- Stock management
- Goods receipts inspection/distribution
- Inventory 1x per quarter
- Planning and checking the tool stock
- Co-ordination and processing of reconditioning
- Continuous inventory reduction
- Assembly, disassembly and pre-setting

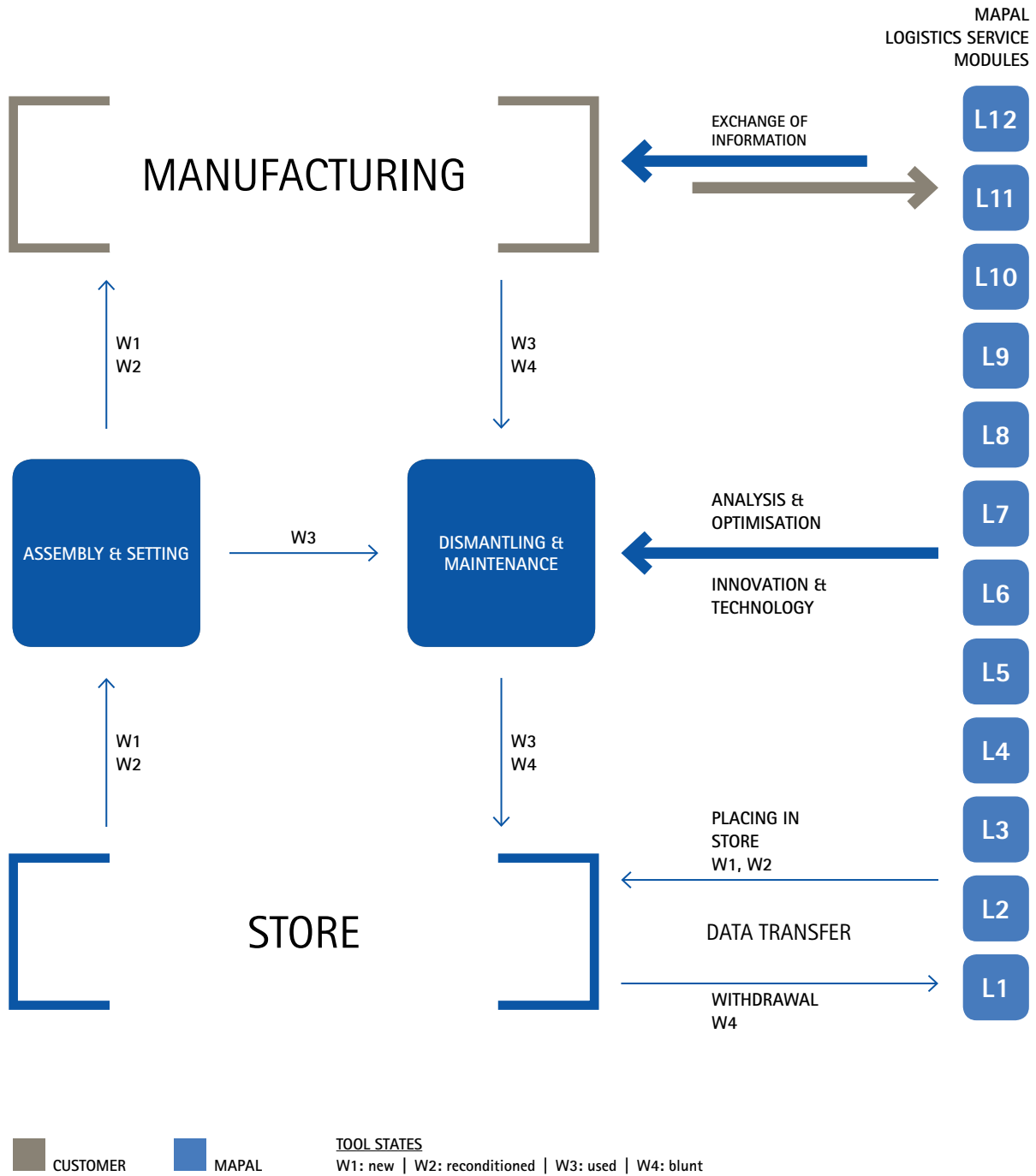

YOUR ADVANTAGES

- 24-hour tool availability in the place of use
- Reduction of the number of suppliers and tools
- Reduction of the tool, inventory, management and invoice costs
- Cost control due to transparent data that can be evaluated electronically
- Defined annual savings
- Lower capital commitment
- Increased machine utilisation
- Use of the latest tool technology

THE MAPAL EFFECT

60 %

COST SAVING

Within six years the customer's production volume increased five-fold. Despite this increase, MAPAL was able to reduce the tool costs in the same period by a total of 60%.



REPEATED SAVINGS BY MEANS OF RECONDITIONING TO ORIGINAL QUALITY



You want to use your tools for longer to save costs? We pick them up and return them quickly and directly in original quality and, upon request, individually modified. Also in the area of actuating, measuring and setting, we ensure long tool life and device service life.

With our know-how and our experience in the area of tool solutions, for us it is straightforward to increase the utilisation of your tools and devices, or to modify standard tools individually for you. During this process you can rely on tailored solutions and worldwide service on-site. You can assemble the support you need as required from our service modules.





A photograph of a modern industrial factory floor. Two men in dark work clothes are standing in the foreground. The man on the left is holding a tablet and looking at the man on the right, who is operating a large yellow and white CNC machine. The machine has a control panel with a screen and a keyboard. In the background, other similar machines and workers are visible, creating a sense of a busy manufacturing environment.

100 %

PERFORMANCE

65 %

LOWER COSTS

If machining tools are re-sharpened to original quality at the right time, the tool costs drop enormously. On a MAPAL twist drill made of solid carbide with high-performance coating, with four re-grinding cycles you save 65% of the costs compared to new procurement.



INVEST IN A LONG TOOL LIFE.

If the issue is the maintenance of your tools, you have all the options at MAPAL. You can send us individual tools for reconditioning, or conclude a complete maintenance contract for specific tools and devices.

We offer our reconditioning service for MAPAL tools as well as for tools from other manufacturers. In addition, as part of our repair service we also repair your tool bodies that are damaged due to chipping or erosion, or that have a damaged insert seat.

Upon request we supply a measurement report that documents the precision and performance of the reconditioned tools. And so that maximum precision is always ensured in your setting room, we also take over the inspection and maintenance of your mechanical or electronic actuating tools, setting and measuring devices. We also offer telephone support and remote maintenance for our tool dispensing systems.

YOUR INITIAL SITUATION

YOU WANT TO CONTINUE TO USE YOUR TOOLS IN ORIGINAL QUALITY

We increase your tool life and reduce your tool costs with original re-grinding and original coating. We pick up your tools on schedule and return them punctually, ready for use, in original quality.

YOU WANT TO HAVE YOUR TOOLS INDIVIDUALLY MODIFIED

Irrespective of whether our tools or tools from other manufacturers; irrespective of whether new or used: on request we individually adapt your standard tools to your requirements. For example, by changing the diameter, polishing chip flutes or adapting the cutting edge geometry to your machining situation.

YOU WANT TO ENSURE PRECISION AND DURABILITY BY MEANS OF MAINTENANCE

To increase the service life of actuating tools, setting and measuring devices, we offer to inspect and service these for you. By means of regular inspection and maintenance, we guarantee precision and process reliability in your production.

OUR MAINTENANCE SERVICES: FOR ALL APPLICATIONS

M1

RECONDITIONING
MAPAL TOOL OR TOOL
FROM OTHER
MANUFACTURER

M2

MODIFICATION OF
TOOLS

M3

REPAIR SERVICE

M4

PREVENTIVE
INSPECTION &
MAINTENANCE



RECONDITIONING, MODIFICATION AND REPAIR IN MAPAL QUALITY

You receive your tools back in original quality, in the shortest possible time, after reconditioning, modification or repair at MAPAL. So that the process is even quicker, upon request we also take over the collection and delivery of your tools.

M1



RECONDITIONING MAPAL TOOL OR TOOL FROM OTHER MANUFACTURER

By reconditioning your tools to original MAPAL quality you again achieve almost 100 % of the tool life of newly purchased tools. That saves costs.

- Re-grinding and coating
- Re-eroding
- Re-tipping with indexable inserts or milling cartridges
- Replacement of wearing parts
- Chromium plating and re-grinding of shanks
- Measurement report service

M2



MODIFICATION OF TOOLS

Beyond the original quality, we individually modify your tools for your production task and return them to you quickly and punctually.

- Modification of length, diameter and cutting edge geometry
- Polishing of the chip flutes
- Individual undercutting on shanks
- High-performance coatings

M3



REPAIR SERVICE

Tool bodies with chipping, erosion and damaged insert seats also receive a second life with our help. We repair them and restore the accuracy true to the original.

- Chromium plating and re-grinding
- Laser deposit welding

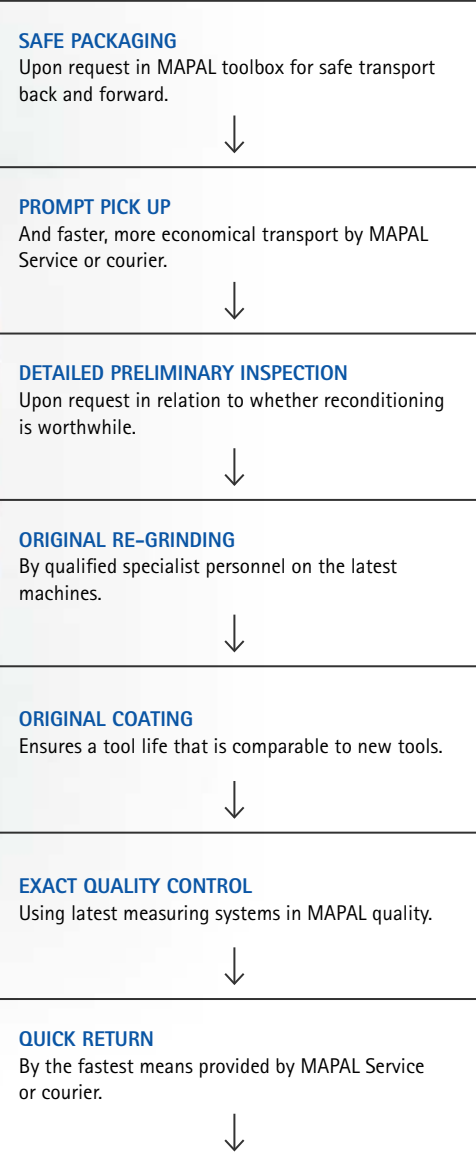

65% COST SAVING
 On reconditioning a MAPAL twist drill made of solid carbide four times with high-performance coating.

BEFORE

AFTER



WE CAN RECONDITION THESE TOOLS FOR YOU

	SINGLE-STEP		MULTI-STEPPED	
	Complete re-grinding	Re-tipping	Axial/radial re-grinding	Complete/partial re-tipping*
TOOLS MADE OF SOLID CARBIDE	■	-	-	-
TOOLS WITH PCD	■	■	-	■
TOOLS WITH GUIDE PADS	-	■	-	-
FIXED MULTI-BLADED REAMERS	■	■	-	-
DRILL HEADS TTD	-	-	-	-
INDEXABLE INSERTS QTD	■	-	-	-

*Nature and scope of the repair is dependent on the related tool.



MAINTENANCE AND INSPECTION BY EXPERTS

By means of expert inspection and maintenance of your actuating tools, setting and measuring devices, we ensure precision, process reliability and reduced costs in your manufacturing.

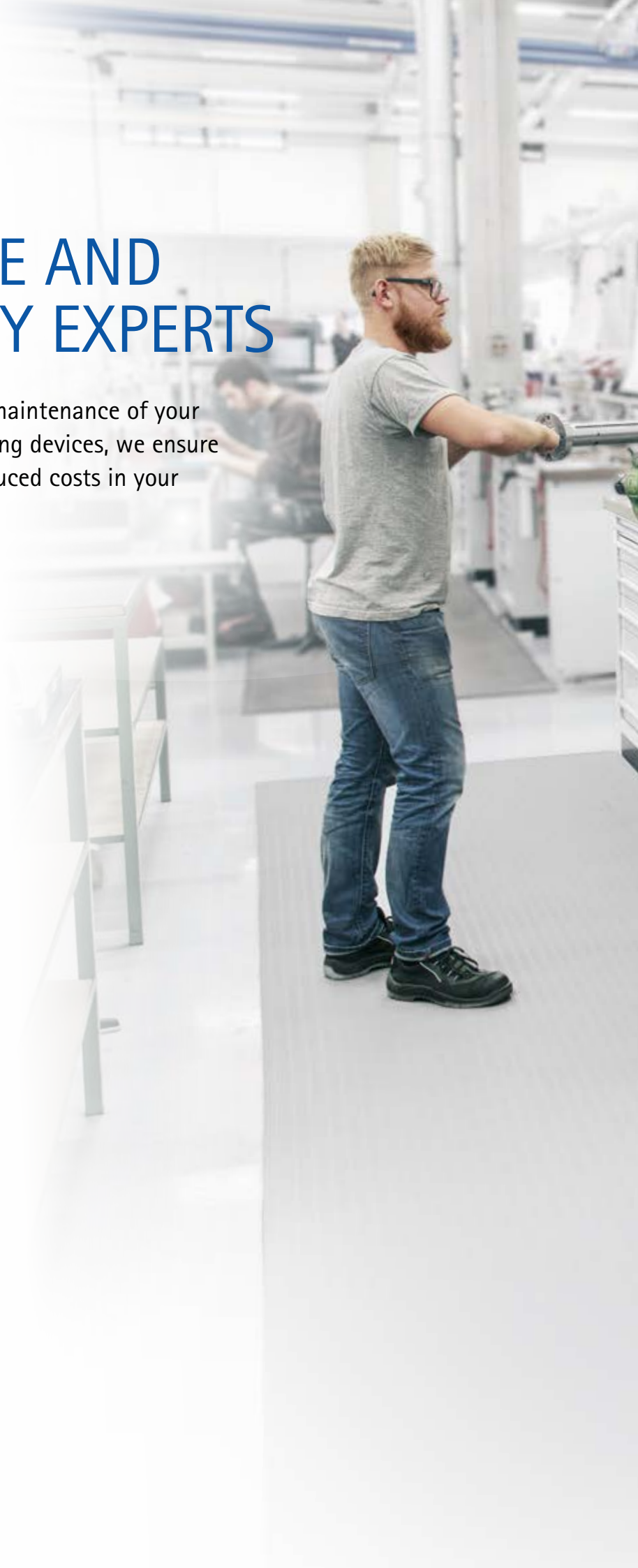

M4



PREVENTIVE MAINTENANCE & INSPECTION

By means of the regular maintenance of your actuating tools, setting and measuring devices, we increase their service life. In this way you avoid irreparable wear and ensure processes are precise and reliable.

- Function check
- Replacement of wearing parts and faulty components
- Balancing of actuating tools
- Calibration of setting and measuring devices
- Software updates for electronic devices
- Telephone support and remote maintenance for tool dispensing systems

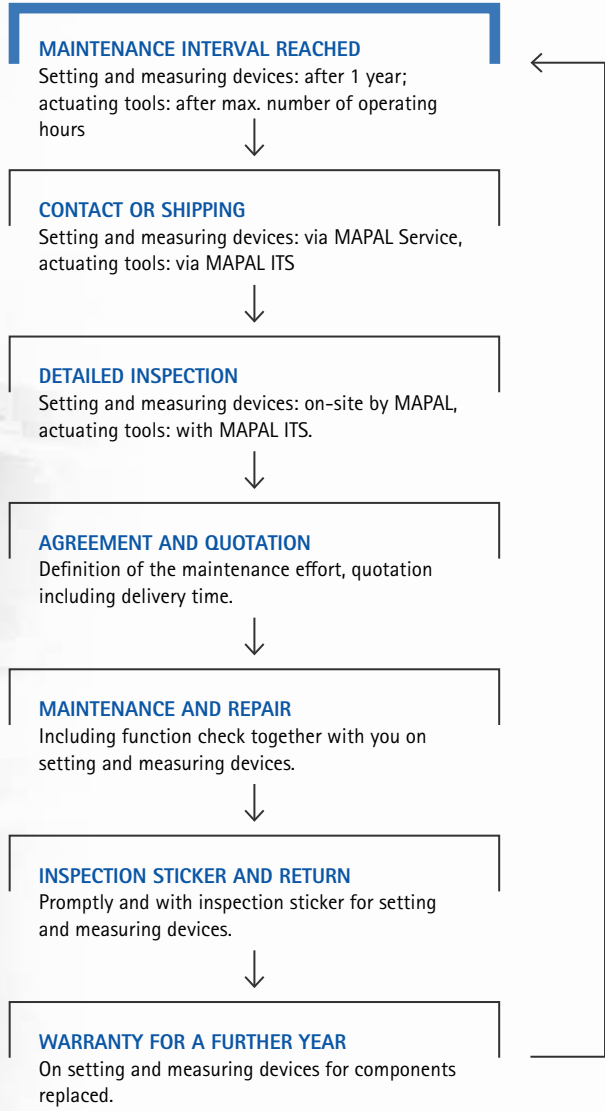

INDIVIDUAL SERVICE CONTRACTS

We would be pleased to prepare, with you, a service concept optimised to your specific needs. Our range of service models includes, for example, customer-specific maintenance contracts that cover all the costs for personnel and their travel expenses. For actuating tools you can conclude three types of service contracts:

1 BASIC

We maintain your various tools at intervals defined in advance. Here we also agree how the maintenance is undertaken with you in advance.

2 COMFORT

Upon request we also stock wearing parts defined together with you. In this way we can repair your tools significantly faster if they need service or repair.

3 COMPLETE

With your service contract, you can completely transfer to us not only the maintenance work that arises, but also the logistics processing and the documentation of the maintenance.

	1 BASIC	2 COMFORT	3 COMPLETE
MAINTENANCE OF THE TOOLS	■	■	■
SPARE PART STOCKING	-	■	■
LOGISTICS PROCESSING	-	-	■



MAINTENANCE SERVICES WORLDWIDE

Irrespective of where you produce in the world, you can be certain to profit on-site from our services for the maintenance of your devices and reconditioning of your tools to original MAPAL quality.



GLOBALLY CONSISTENT **QUALITY STANDARDS**



MANUFACTURING AND RECONDITIONING OF TOOLS **FROM A SINGLE SOURCE**



RECONDITIONING WORLDWIDE USING **IDENTICAL** MACHINES AND SOFTWARE



CONTACT PARTNERS IN EVERY COUNTRY



SERVICE ON-SITE ALSO FOR COMPLEX TOOL SYSTEMS
e.g. ACTUATING TOOLS AND SETTING FIXTURES



EASY, QUICK AND PUNCTUAL **PROCESSING**



HIGH-QUALITY EQUIPMENT, GRINDING WHEELS, ETC.



ALL PRODUCTION SITES COVERED BY **LOCAL SERVICE CENTRES**



QUALIFIED, SPECIFICALLY **TRAINED SERVICE PERSONNEL** WORLDWIDE



KNOW-HOW FROM THE SPECIALISTS. PREPARED ORIENTATED ON PRACTICE FOR YOUR STAFF.



If the issue is the optimisation of your processes, your staff are an important factor. As only qualified employees can fully exploit the potential of your tools and machines and in this way achieve cost savings.

With our training program, we start from where your staff are. Irrespective of whether the issue is to convey basic knowledge, or you want to profit from our wide-ranging know-how in the area of modern machining processes. With the associated training workshop and the technology centre, the MAPAL Academy offers the greatest possible relevance to practice in every case.



500

PARTICIPANTS PER YEAR

From machine operators to staff in process technology: during tailored seminars everyone who is involved in the planning, setting up, programming and operation of your machines and processes quickly profits directly from our know-how as a technology leader in machining.



INVEST IN YOUR STAFF.

Divided into five training areas, our range of training courses convey comprehensive know-how. Here you can choose whether to have your staff trained on-site in your organisation, or in the MAPAL Academy in Aalen.

Our didactically qualified training experts provide your staff with special knowledge directly from practice. Further training seminars on the basics of machining form only the basis. In addition, we offer technology, sector and part seminars during which your staff learn all about the usage of the latest manufacturing processes. Last but not least, our training program includes individual seminars that are exactly tailored to your needs. We agree the content and objectives in detail with you in advance.

Theory and practice are closely interlinked in all our seminars. With the associated training workshop and technology centre, our MAPAL Academy offers seminar participants the possibility, in particular, to experience and try out training content directly in practice.



YOUR INITIAL SITUATION

YOU WANT TO FURTHER TRAIN YOUR STAFF IN A SPECIFIC AREA

In our basic seminars and advanced seminars we convey sound knowledge related to machining. The seminars are aimed in particular at qualified personnel, supervisors, technicians and engineers.

YOU WANT TO INCREASE YOUR COMPETITIVENESS

In our technology, sector and part seminars you learn everything about the usage of the latest manufacturing technologies and processes with which you can sustainably increase your productivity.

YOU WANT TO INCREASE YOUR PROCESS RELIABILITY

Our technology experts prepare customer-specific seminars especially to suit your requirements. Whether part, product or process-related: the objective is always to make your processes as effective and reliable as possible.

OUR TRAINING COURSES: NEEDS-BASED AND WITH HIGH LEVEL OF PRACTICAL CONTENT

T1

BASIC SEMINARS

T2

ADVANCED SEMINARS

T3

TECHNOLOGY
SEMINARS

T4

SECTOR AND PART
SEMINARS

T5

CUSTOMER-SPECIFIC
SEMINARS

YOU SELECT THE LOCATION

MAPAL ACADEMY AALEN

The seminar rooms in our academy are equipped with the latest media equipment. In addition, knowledge can also be conveyed and tried out in our highly modern technology centre and our training workshop directly at the machine.

ON-SITE IN YOUR ORGANISATION

You want to have your staff trained on-site in your premises and specifically define the timing and the duration of the training course? This again is not a problem. Irrespective of where you produce in the world, our training experts will come to you.



SPECIFIC FURTHER TRAINING BY EXPERTS

In our basic seminars engineers, technicians and experienced specialist personnel obtain insights into machining technology and the MAPAL product range. This know-how can then be specifically reinforced in advanced seminars.



The starting point is always the latest state-of-the-art. All participants profit from the machining competence and the wealth of experience of our speakers. And because the seminar content is conveyed in small groups, trusting and effective collaboration develops between the participants and trainers after a very short time.

T1



BASIC SEMINARS

Theory and practice of machining for engineers, technicians and specialist staff from the metal sector.

OUR RANGE OF SEMINARS

- Machining theory
- Reaming and fine boring tools
- Tools for drilling, boring, countersinking
- Milling tools
- Clamping system
- Actuating tools
- Devices for measuring, setting, dispensing

YOUR ADVANTAGES

- Seminars with high level of practical content
- Experienced speakers
- Latest state-of-the-art
- Knowledge conveyed effectively in small groups



Theory and practice go hand in hand, in this way even challenging technical details are immediately understandable for all participants. Insights into production as well as application examples and examples of successes supplement the theoretical information. And because our participants are actively involved in the seminar content, they can ask questions and raise problems at any time and are therefore committed and enthusiastic.

T2



ADVANCED SEMINARS

For participants who have completed our basic seminars and others with comparable knowledge.

OUR RANGE OF SEMINARS

- Machining theory for the advanced
- Design of PCD tools for drilling, boring, countersinking
- Milling tools II
- Actuating tools TOOLTRONIC®

YOUR ADVANTAGES

- Specific reinforcement of the know-how from the basic seminars



TECHNOLOGY, SECTOR AND PART SEMINARS

In our technology, sector and part seminars you profit from our many years of experience, our sound know-how as a tool and process specialist, as well as our latest findings from research and development.



In our technology seminars your staff become familiar with modern processes from machining technology and try them out directly on-site at the machine. The participants are then able to introduce the related methods into your production and in this way to optimise your production processes.

T3



TECHNOLOGY SEMINARS

For engineers, technicians and experienced specialist personnel with sound knowledge of machining.

OUR RANGE OF SEMINARS

- Hard machining
- Minimum quantity lubrication
- Machining thermal spray coatings
- Machining lightweight materials
- Trochoidal milling
- Interpolation turning and TOOLTRONIC®

YOUR ADVANTAGES

- Preparation of your staff for the introduction of new machining processes and tool technologies
- Increase in the technical know-how of your staff
- Practice-orientated seminars at the machine for sustainable learning success
- High-quality learning content due to experienced specialists from practice

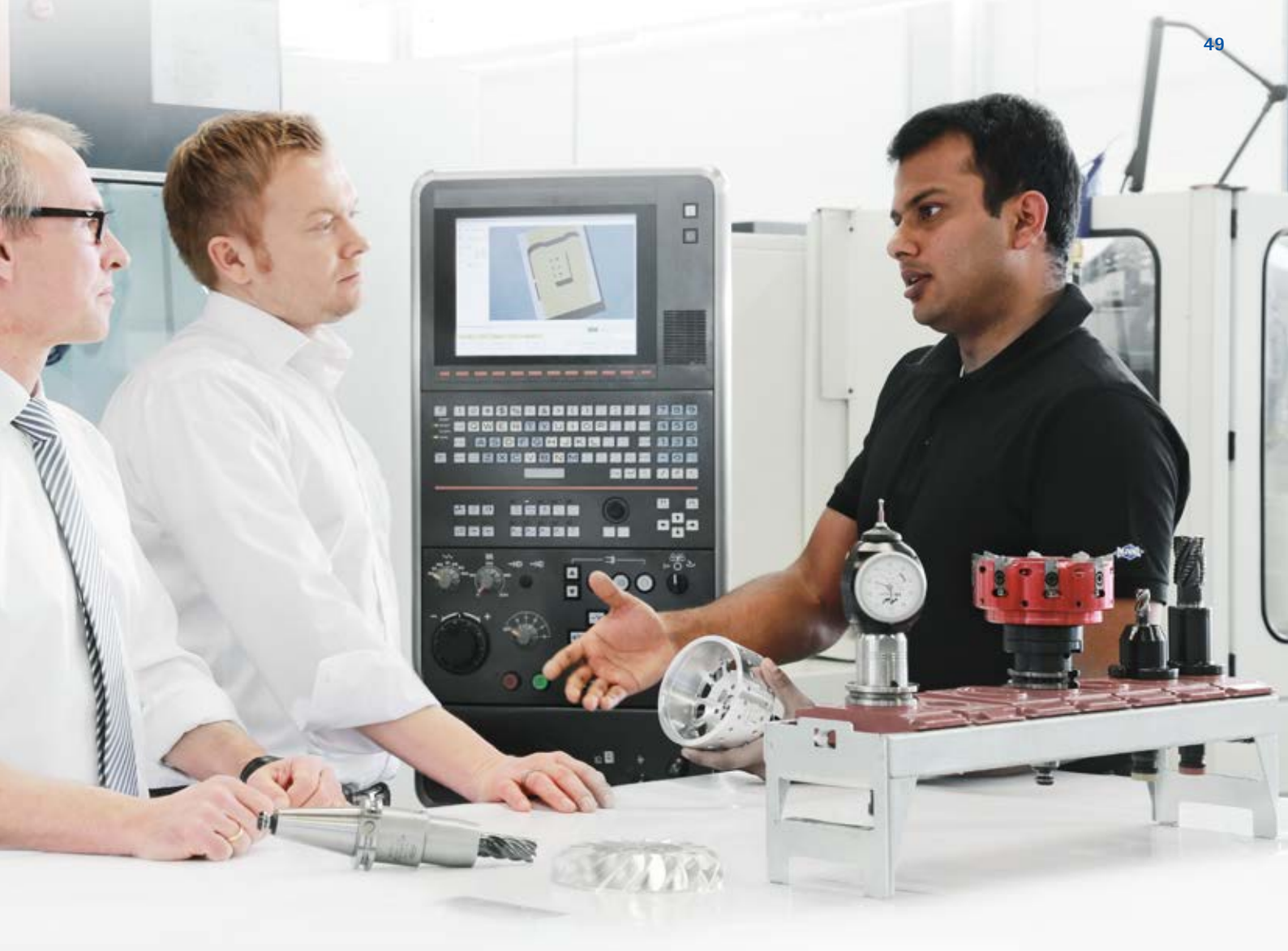

In our sector and part seminars we convey to your staff detailed knowledge of the machining of specific parts. Learning content here is, e.g., part clamping systems, cutting data and tool lives, cost per part calculations and general figures for the total cost of ownership. The seminars are based on the knowledge of our technology experts who have specialised on specific parts based on many years of experience. The participants are able to optimise the machining processes for the related parts and during this process profit from special MAPAL tool solutions.

T4



SECTOR AND PART SEMINARS

For engineers, technicians and experienced specialist personnel with sound knowledge of machining.

OUR RANGE OF SEMINARS

- Automotive (e.g. turbocharger, brake caliper, engine block, gearbox housing)
- Aerospace (e.g. structural parts, propulsion)
- Machine and plant engineering (e.g. bearing housing, actuator)
- Wind power (e.g. rotor blade, rotor hub, gearbox, generator)

YOUR ADVANTAGES

- Comprehensive understanding of the process by your staff for the complete machining of various parts
- Full exploitation of the potential of your tools
- Increased productivity of your machining process
- Know-how directly from practice from experienced technology experts



CUSTOMER-SPECIFIC SEMINARS

To increase your process reliability, together with you we develop customer-specific seminars that are individually tailored to the training needs of your staff.



We agree the exact schedule and the content with you in detail in advance. During this process we analyse the individual training needs of your staff and develop a training concept specially tailored to your requirements.

Possible objectives that you can achieve by means of customer-specific seminars from MAPAL are, for example: better utilisation of machine potential, reduction of tool or tool change costs, optimisation of machining processes and costs, increased tool lives and reduced machine downtime. You achieve these objectives by increasing, with our help, the know-how and understanding of your staff in relation to the processes and the technical relationships. As you can only increase the reliability of your processes with staff who think and act in a solution-orientated manner.

T5



CUSTOMER-SPECIFIC SEMINARS

Individually tailored to your machining processes and the training needs of your staff.

OUR RANGE OF SEMINARS

- Tailored training courses matched to your needs

YOUR ADVANTAGES

- Specifically increase the know-how of your staff
- Full exploitation of the potential of your machines
- Increased process reliability

ORGANISATION

MAPAL ACADEMY

Since July 2014 most of our seminars have been held in the MAPAL Academy in Aalen. Our academy has seminar rooms with the latest media equipment. Due to the direct connection to the MAPAL technology centre and training workshop, our academy offers the opportunity to combine theory and practice perfectly. All seminars can also be held on-site in your organisation.



TRAINERS

Our trainers have gained many years of experience as technology experts at MAPAL and are didactically qualified to pass on this experience to your staff practically and using the latest training methods. The findings from our research and development also flow continuously into the seminars.

SEMINAR DOCUMENTATION & CERTIFICATES

Following successful participation in one or more seminars, your staff will receive a certificate of attendance. In addition, we make comprehensive seminar documentation available to all participants. In this way they can refer back at any time and refresh their know-how.

LANGUAGES & DATES

We hold the seminars in German, English and, upon request, also in French. Simply ask the MAPAL Academy about the related dates or agree a training course in your organisation.

SERVICE

We would be pleased to advise you on the selection of the seminars or seminar content. We will also provide suggestions for travel, make flight and hotel bookings, collect your staff from the railway station or airport and make suggestions for the evening and weekend program.



Discover tool and service solutions now that give you a lead:

REAMING | FINE BORING

DRILLING FROM THE SOLID | BORING | COUNTERSINKING

MILLING

TURNING

CLAMPING

ACTUATING

SETTING | MEASURING | DISPENSING

SERVICES

www.mapal.com