

EUROPEAN
CATALOGUE
[DIN · JIS · ANSI]

YEU21

“Reliable screw threads” is
YAMAWA’s theme



 Think threads with
YAMAWA

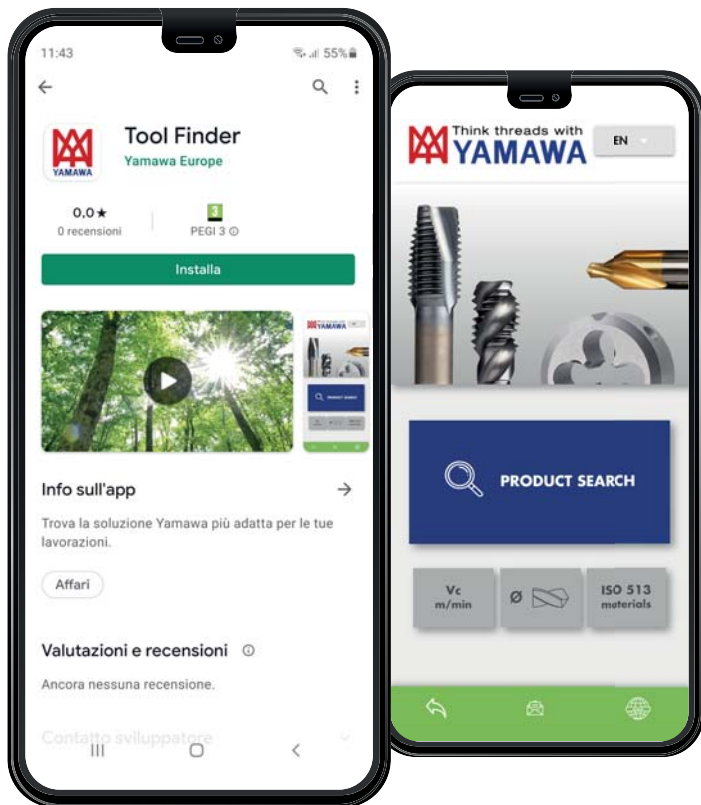

APP TOOL FINDER YAMAWA

Scan the QR code to get the app or look for Tool Finder Yamawa on app stores.

- Tool Finder is free of charge and does not require registration.
- The stock range is constantly updated.
- Data are available online, so database download on the device is not necessary.

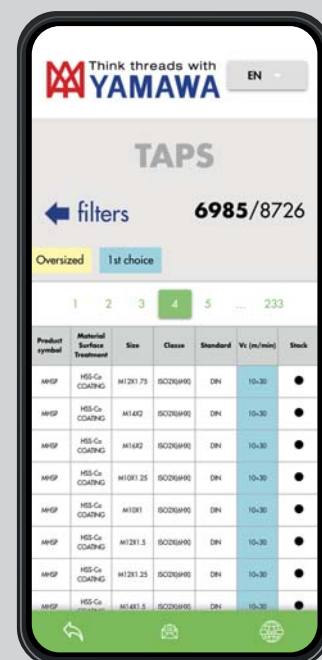
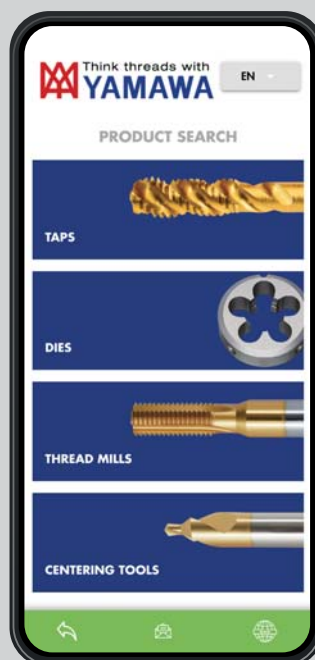



APP

TOOL FINDER

- FIND THE MOST SUITABLE TOOL
- BORED HOLE CALCULATOR
- PARAMETERS CALCULATOR
- MATERIALS BY ISO 513 STANDARD
- AVAILABLE IN 6 LANGUAGES

All Yamawa solutions at your fingertips

It takes only a few seconds to choose from the wide range of taps, dies, threading mills, or centering tools.



A close-up photograph of a green stem with several small, light pink flowers. The flowers are in various stages of bloom, with some showing their delicate petals and stamens. The background is a soft, out-of-focus light blue and green, suggesting a natural setting. The overall mood is fresh and vibrant.

**“Reliable screw threads” is
YAMAWA’s theme**

General Index	4
Alphanumeric Index	6
Tap Series Classification	7
Catalogue Structure	10
Product Search System	16
Hardness conversion table	20
System Chart by ISO 513 Classification	21
Line Up arranged by type of threads	45
Icons	70

General Index



INTRO

- 6 Alphanumeric Index
- 7 Tap Series classification
- 10 Catalogue Structure
- 16 Product Search System
- 20 Hardness conversion table
- 21 System Chart Index by ISO 513 Classification
- 45 Line up arranged by type of thread
- 70 Icons

- 73 **SP**
Spiral fluted taps
for blind hole



- 191 **SL**
Left spiral fluted taps
for through hole



- 207 **PO**
Spiral pointed taps
for through hole



- 259 **ST**
Straight fluted taps for
blind and through hole

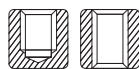

- 347 **ROLL**
Thread forming taps



- 391 **CARBIDE**
Carbide taps



- 427 **LONG**
Long shank taps





495

HAND TAPS

Taps for manual use and for drilling machines

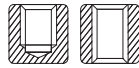

507

EG (STI)

Taps for Helical coil wire screw thread inserts

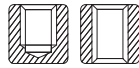

531

SPECIAL THREADS, GAUGES

Taps for special threads and simple measuring instruments for internal thread and bored hole diameters



583

THREAD MILLS



591

DIES



603

CENTER DRILLS

Center drills and centering tools



623

TECHNICAL INFO

751

COMPANY INFORMATION

Alphanumeric index

🇮🇹 Indice alfanumerico 🇩🇪 Alphanumerischer Index 🇫🇷 Index alphanumérique 🇪🇸 Índice alfanumérico 🇷🇺 Алфавитный указатель

Intro

SP

SL

PO

ST

ROLL

CARBIDE

LONG

HAND TAPS

EG (STI)

SPECIAL THREADS, GAUGES

THREAD MILLS

DIES

CENTER DRILLS

Technical info

PRODUCT NAME	DIN	JIS	ANSI	YMW
6000	537			
6110	498			
6412	502			
ACHSP		420		
AL+SP/AL-SP	140	168		
AL-HT STI		514		
AL-PO STI		512		
AL-SP 1.5P		170		
AL-SP STI		510		
AU+SL	196			
AU+SP	120			
AUCDS				612
AUCES				610
AUPEQ				618
AUPES				620
AUSP G	84			
AUSP Rc	86			
AUSP Rp	85			
AUXSL	198			
AUXSP	122			
AXE-HT	286			
CD-A	606			
CD-R	607			
CD-SL				608
CPC-S				568
CPR-S				580
CT FC	394			
CT LA	396			
CT-PF		407		
DPO	594			
EH-CT	398			
EH-HT	274			
EH-PO	224			
F-SL	202			
F-SP	146			
GG-HT	278			
GG-HT TiCN	280			
GG-HT-OH TiCN	282			
GGST	264			
GGST CH	266			
GGST CH E(1.5P)	268			
HDISL	203			
HFACT-B		424		
HFACT-P		425		
HFAHS	149			
HFASP	150			
HFICT-B		422		
HFICT-P		423		
HFIHS	147			
HFISP	148			
HP+RZ/HP-RZ	358	378	388	
HPsRZ		543		
HS-D		598		
HT	270	288	334	
HT BC		552		
HT CTC		554		
HT CTG		555		
HT CTV		551		
HT DIN352	500			
HT DIN5157	503			
HT LH		314		
HT Pg	536			
HT STI			528	
HT TRI		547		
HT TV		549		
HVSP	88			
IHT		506		

PRODUCT NAME	DIN	JIS	ANSI	YMW
IPO		505		
ISP		504		
LA-HT	284	328		
LO-SP	116			
LO-SP OX	118			
LS-HT		462		
LS-HT LH		480		
LS-HT V		484		
LS-N-CT		408		
LS-N-RS		492		
LS-N-RZ		490		
LS-NPT		478		
LS-NPTF		479		
LS-PF		474		
LS-PM-PO		458		
LS-PM-SP		444		
LS-PO		448		
LS-PO V		455		
LS-PO-K		454		
LS-PS		475		
LS-PT		476		
LS-SP		432		
LS-SP LH		440		
LS-SP V		441		
LS-SP-K		439		
LS-SP-PF		438		
LS-SU-S-PO		460		
LS-SU-S-SP		446		
MC-AD-CT		418		
MC-HT		486		
MC-PO		456		
MC-SP		442		
MG-HT		331		
MHCDS				614
MHRZ	350			
MHSL	194			
MHSP	92			
MS+RS		542		
MS+TR		541		
N+RS/N-RS	357	372		
N+RZ/N-RZ	356	366		
N-CT FC		402		
N-CT LA		414		
N-CT-PO		412		
N-CT-SP		410		
N-RS STI		518		
NC-SD V				616
NPS			342	
NPSF			343	
NPT			340	
NPTF			341	
NT		538		
OL+RZ/OL-RZ	360	386		
PF LH		323		
PH-SP	124			
PL1		332		
PM-PO	222			
PM-SP	126			
PMSP	128			
PMST	276			
PO	212	232		
PO LH		240		
PO OX	218			
PO STI			524	
PO V	220			
PO-VA	226			
PO-VA TiCN	229			

PRODUCT NAME	DIN	JIS	ANSI	YMW
PRML				586
PRML TI				588
R+V		362		
R-D	352			
R-D V	354			
RLS-HT		548		
SC-TL-RZ		384		
SIT				556
SITD				562
SL LH Tr		545		
SL Tr		544		
SL+VA	199			
SP	94	152	172	
SP 1.5P		160		
SP LH	104	162		
SP OX	108			
SP STI			520	
SP TRI		546		
SP V	114			
SP+VA	130			
SP-BLF	100			
SP-BLF 1.5P	102			
SP-BLF OX	106			
SP-BLF V	112			
SP-VA	132			
SP-VA TiCN	136			
SU+PO/SU-PO		242		
SU+SP/SU-SP		164		
SU-HT		324		
SU2-SP	138			
SURZ		382		
UH-CT	400			
VUPO	210			
VUSP	80			
VUSP E(1.5P)	82			
ZELX AL PO			254	
ZELX AL SP			182	
ZELX MOLD			344	
ZELX MOLD NPT			346	
ZELX NI PO			256	
ZELX NI PO STI			526	
ZELX NI SP			184	
ZELX NI SP STI			522	
ZELX SS NPT			180	
ZELX SS NPTF			181	
ZELX SS PO			250	
ZELX SS SP			176	
ZELX TI LHSP			204	
ZELX TI SP			188	
ZEN-B	142			
ZEN-P	230			
ZET-B	144			
ZET-P	200			

Tap Series Classification

YAMAWA TAP SERIES





 Our range is composed by 6 different "TAP SERIES", each defined by specific technical features (raw materials, cutting geometries, surface treatments) and designed to match the various manufacturing reality such as small or large batches, cost or performance orientation, modern or conventional machines.

 Classifichiamo i nostri prodotti in diverse "TAP SERIES" caratterizzate da differenti specifiche tecniche in termini di materiale dell'utensile, geometria di taglio, trattamento superficiale per poter soddisfare al meglio le diverse esigenze produttive legate alla fabbricazione di piccoli o grandi lotti, al parco macchine più o meno moderno, alla necessità di porre il focus sul costo o sulle performance dell'utensile.

 Wir klassifizieren unsere Produkte nach verschiedenen "GEWINDEBOHRER-SERIEN", die sich durch unterschiedliche technische Spezifikationen in Bezug auf Werkzeugmaterial, Schneidengeometrie, Oberflächenbehandlung auszeichnen, um den unterschiedlichen Produktionsbedürfnissen im Zusammenhang mit der Herstellung von Klein- oder Großserien, dem mehr oder weniger modernen Maschinenpark, der Notwendigkeit, sich auf die Kosten oder die Leistung des Werkzeugs zu konzentrieren, am besten gerecht zu werden.

 Nous classons nos produits en différentes « TAP SERIES » caractérisées par des spécifications techniques différentes en termes de matériau de l'outil, de géométrie de coupe et de traitement superficiel pour répondre au mieux aux différents besoins de production liés à la fabrication de petites ou de grandes séries, au parc de machines récent ou traditionnel, à la nécessité de privilégier le coût ou les performances de l'outil.

 Nuestra gama de productos está compuesta por 6 diferentes "TAP SERIES", cada una definida por específicas características técnicas (materia prima, geometría de corte, tratamiento superficial) y diseñadas para satisfacer diferentes producciones de pequeño o gran consumo, orientadas al precio o al rendimiento y con máquinas modernas o convencionales.

 Наш инструмент классифицирован на 6 "Серий". Они различаются техническими характеристиками (исходный материал, геометрия, покрытие) и предназначены для решения определенных производственных задач. Принимается во внимание размер партии, важность низкой стоимости или высокой производительности, использование станка с ЧПУ или универсального оборудования.

Intro

SP

SL

PO

ST

ROLL

CARBIDE

LONG

HAND TAPS

EG (STI)

SPECIAL THREADS, GAUGES

THREAD MILLS

DIES

CENTER DRILLS

Technical info

Intro

SP

Z PRO Series



SL

✚ The evolution of high performance tapping.

High performance solution for various kinds of workpiece materials and applications. Z-Pro series represent the outstanding result of almost 100 years of expertise in combining high quality raw materials and coatings with innovative cutting geometries.

🇫🇷 L'évolution du taraudage haute performance.

Solution haute performance pour les machines CNC de dernière génération; produits adaptés au filetage d'une grande variété de matériaux avec utilisation d'émulsion. Pour les entreprises à la recherche d'outils performants, fiables et polyvalents.

PO

🇮🇹 L'evoluzione della maschiatura ad alto rendimento.

Soluzioni alto performanti per un'ampia gamma di materiali e applicazioni. La serie Z-Pro rappresenta l'eccezionale risultato di quasi 100 anni di esperienza nel combinare materiali di base di alta qualità e rivestimenti di ultima generazione con geometrie di taglio innovative.

🇪🇸 La evolución del roscado de alto rendimiento.

Solución de alto rendimiento para diferentes materiales y aplicaciones. La serie Z-Pro es el fruto de casi 100 años de experiencia combinando materia prima y recubrimientos de alta calidad con geometrías de corte innovadoras.

ST

🇩🇪 Die Evolution des Hochleistungs-Gewindeschneidens.

Hochleistungswerkzeuge, geeignet für das Gewindeschneiden einer Vielzahl von Materialien. Die Z-Pro Produktlinie ist das hervorragende Ergebnis einer fast 100-jährigen Erfahrung. Die Kombination von hochqualitativen Substraten mit spezieller Beschichtung und innovativen Schnittgeometrien.

🇷🇺 Новое слово в области высокопроизводительного нарезания резьбы.

Высокопроизводительное решение для обработки различных материалов. Z-Pro серия обладает высокими рабочими характеристиками, благодаря высочайшему качеству исходного материала, специальному покрытию и особой режущей геометрии.

ROLL

CARBIDE

HT HAND TAPS Series



LONG

✚ HAND TAP

Products designed for hand and drilling machine application (HT hand sets and I series).

🇫🇷 TARAUDS À MAIN

Gamme développée pour les applications manuelles ou sur perceuses (série HT manuelle et Série I).

HAND TAPS

🇮🇹 MASCHI A MANO

Gamma sviluppata per applicazioni manuali o su trapani. (HT serie a mano e I Series)

🇪🇸 MACHOS DE MANO

Gama desarrollada para aplicaciones manuales o con taladro. (Serie HT a mano y Serie I)

EG (STI)

🇩🇪 HANDGEWINDEBOHRER

Eine Produktreihe, die für manuelle Anwendungen oder für die Bohrmaschine entwickelt wurde (Serie HT Handgewindebohrer und Serie I)

🇷🇺 РУЧНЫЕ МЕТЧИКИ

Инструмент предназначен для нарезания резьбы вручную или с помощью универсального оборудования (наборы метчиков в серии HT и серия I).

SPECIAL THREADS, GAUGES

GP GENERAL PURPOSE Series



THREAD MILLS

✚ GENERAL PURPOSE

The ideal solution for small batches on various kind of workpiece materials.

🇫🇷 UTILISATION GENERALE

La solution idéale pour la production de petites séries. Applicable sur différents matériaux.

DIES

🇮🇹 GENERAL PURPOSE

La soluzione ideale per produzione di piccoli lotti. Applicabile su vari materiali.

🇪🇸 USO GENERAL

La solución ideal para el roscado de lotes pequeños. Aplicable a varios materiales.

CENTER DRILLS

🇩🇪 ALLGEMEINE ANWENDUNG

Die ideale Lösung für die Kleinserienproduktion. Anwendbar auf verschiedenen Materialien.

🇷🇺 ОБЩЕЕ НАЗНАЧЕНИЕ

Идеальное решение для обработки небольших партий деталей из различных материалов.

Technical info

MP MULTI PURPOSE Series



SP

SL

PO

ST

ROLL

CARBIDE

LONG

HAND TAPS

EG (STI)

SPECIAL THREADS, GAUGES

THREAD MILLS

DIES

CENTER DRILLS

Technical info

✚ MULTI PURPOSE

High performance solution for various kind of work-piece materials. Suitable for those users looking for performance (tool life, speed), reliability and flexibility.

🇮🇹 POLIVALENTI

Soluzione ad alto rendimento per una vasta gamma di materiali. Per aziende che ricercano utensili performanti, affidabili e versatili.

🇩🇪 MULTI-MEHRZWECK

Hochleistungslösung für eine breite Palette von Materialien. Für Unternehmen, die leistungsstarke, zuverlässige und vielseitige Werkzeuge suchen.

🇫🇷 POLYVALENCE

Solution à haut rendement pour une vaste gamme de matériaux. Pour les entreprises à la recherche d'outils performants, fiables et polyvalents.

🇪🇸 MULTIUSO

Solución de alto rendimiento para una amplia gama de materiales. Para clientes que buscan rendimiento (vida útil, velocidad,...), fiabilidad y versatilidad.

🇷🇺 УНИВЕРСАЛЬНЫЕ

Высокопроизводительное решение для широкого спектра материалов. Для предприятий, нуждающихся в высокопроизводительных, надежных и универсальных инструментах.

MS MATERIAL SPECIFIC Series



✚ MATERIAL SPECIFIC

In this product family, each cutting geometry is designed to deliver the best performance (life and reliability) on a specific workpiece materials.

🇮🇹 PER MATERIALI SPECIFICI

Questa serie di prodotti è caratterizzata da utensili con geometrie di taglio per ottenere le migliori performance (durata e affidabilità) su materiali specifici.

🇩🇪 MATERIALSPEZIFISCHE ANWENDUNG

Hochleistungslösung für eine breite Palette von Materialien. Für Unternehmen, die leistungsstarke, zuverlässige und vielseitige Werkzeuge suchen.

🇫🇷 MATÉRIAUX SPÉCIFIQUES

Pour cette série de tarauds chaque géométrie de coupe est étudiée pour obtenir les meilleures performances (durée et fiabilité) sur des matériaux spécifiques.

🇪🇸 MATERIALES ESPECÍFICOS

En esta serie, cada geometría de corte está desarrollada para obtener el mejor rendimiento (durabilidad y fiabilidad) en materiales específicos.

🇷🇺 СПЕЦИАЛИЗИРОВАННЫЕ МЕТЧИКИ

Каждый инструмент этой серии специально разработан для достижения оптимального результата (стойкости и надежности) при обработке определенной группы материалов.

HS HIGH SPEED Series



✚ HIGH SPEED

In this product family, specific geometries, substrates and coatings allow long life even at Fast and Ultra Fast speed. Suitable for those customers looking for cost saving through to cycle-time reduction.

🇮🇹 ALTA VELOCITÀ

Questa serie di prodotti è stata sviluppata con geometria di taglio, substrato e trattamento superficiale specifici per garantire lunga durata anche alle alte velocità. Per aziende che ricercano il cost-saving grazie alla riduzione del tempo-ciclo.

🇩🇪 HOHE GESCHWINDIGKEIT

Diese Produktreihe wurde mit einer speziellen Schneidengeometrie, einem speziellen Substrat und einer speziellen Oberflächenbehandlung entwickelt, um eine lange Lebensdauer auch bei hohen Geschwindigkeiten zu garantieren. Für Unternehmen, die Kosteneinsparungen durch die Reduzierung der Zykluszeit anstreben.

🇫🇷 HAUTE VITESSE

Cette série de produits a été développée avec une géométrie de coupe, un substrat et un traitement superficiel de surface spécifique pour garantir une plus longue durée de vie y compris à haute vitesse. Destinée aux utilisateurs qui veulent réduire leurs coûts en abaissant le temps de cycle.

🇪🇸 ALTA VELOCIDAD

En esta familia de productos, las geometrías de corte específicas, los substratos y los recubrimientos aportan una vida útil mayor en velocidades Fast y Ultra Fast. Adecuado para aquellos clientes que buscan un ahorro de costes a través de la reducción del tiempo de ciclo productivo.

🇷🇺 ВЫСОКОСКОРОСТНЫЕ МЕТЧИКИ

Инструменты этой серии обладают специальной геометрией и изготовлены из особых материалов с покрытием. Они обеспечивают высокую стойкость при работе с высокими и ультра-высокими скоростями резания. Предназначены для пользователей, которым необходимо снижение себестоимости продукции за счет уменьшения времени цикла обработки.

GENERAL INDEX STRUCTURE

SP

SL

PO

ST

ROLL

CARBIDE

LONG

HAND TAPS

EG (STI)

SPECIAL THREADS, GAUGES

THREAD MILLS

DIES

CENTER DRILLS

Technical info

General Index



INTRO

- 006 Alphanumeric Index
- 007 Tap Series classification
- 010 Catalogue Structure
- 016 Product Search System
- 020 Hardness conversion table
- 021 System Chart Index by ISO 513 Classification
- 045 Line up arranged by type of thread
- 070 Icons

SP

- 073 Spiral fluted taps for blind hole



SL

- 191 Left spiral fluted taps for through hole



PO

- 207 Spiral pointed taps for through hole



ST

- 259 Straight fluted taps for blind and through hole



ROLL

- 347 Thread forming taps



CARBIDE

- 391 Carbide taps



LONG

- 427 Long shank taps



15 THUMB INDEX MACRO SECTIONS

- INTRO - How to read the catalogue and product search
- SP - Spiral fluted taps for blind holes
- SL - Left spiral fluted taps for through holes
- PO - Spiral pointed taps for through holes
- ST - Straight fluted taps for blind and through holes
- ROLL - Forming taps for blind and through holes
- CARBIDE - Carbide taps
- LONG - Long shank taps
- HAND TAPS - Taps for manual use and for drilling machines
- EG (STI) - Taps for helical coil wire thread insert
- SPECIAL THREADS, GAUGES - Taps for special threads and simple measuring instruments for internal thread and bored hole diameters
- THREAD MILLS - Tools for helical interpolating process
- DIES - Solid dies
- CENTER DRILLS - Center drills and centering tools
- TECHNICAL INFO - Section with technical information









RUBRICATURA CON 15 MACRO CAPITOLI

- INTRO - Guida al catalogo e ricerca dei prodotti
- SP - Maschi elicoidali per fori ciechi
- SL - Maschi con elica sinistra per fori passanti
- PO - Maschi con imbocco corretto per fori passanti
- ST - Maschi con scanalature diritte per fori passanti e ciechi
- ROLL - Maschi a rullare per fori ciechi e passanti
- CARBIDE - Maschi in metallo duro
- LONG - Maschi con gambo lungo
- HAND TAPS - Serie di maschi a mano e per uso su trapani
- EG (STI) - Maschi per filetti riportati Helicoil
- SPECIAL THREADS, GAUGES - Maschi per filettature speciali e utensili di misura per filetti interni e prefori
- THREAD MILLS - Utensili per filettatura ad interpolazione
- DIES - Filiere integrali
- CENTER DRILLS - Punte e utensili a centrare
- TECHNICAL INFO - Sezione tecnica

REGISTER MIT 15 MAKROKAPITELN

- INTRO - Wie man den Katalog liest und die Produktsuche
- SP - Spiralgenuteter Gewindebohrer für Sacklöcher
- SL - Gewindebohrer mit linksgedrehter Spiralnut für Durchgangslöcher
- PO - Gewindebohrer mit Schälanschnitt für Durchgangslöcher
- ST - Geradegenuteter Gewindebohrer für Durchgangs- und Sacklöcher
- ROLL - Gewindeformer, für Sack- und Durchgangslöcher
- CARBIDE - Hartmetall-Gewindebohrer
- LONG - Gewindebohrer mit langem Schaft
- HAND TAPS - Serie von Handgewindebohrern für den Einsatz auf Bohrmaschinen
- EG (STI) - Gewindebohrer für Helicoil-Gewindeeinsätze
- SPECIAL THREADS, GAUGES - Gewindebohrer für Spezialgewinde und spezielle Branchen, Sortiment an Messwerkzeugen der Innengewinde und Kernlöcher
- THREAD MILLS - Werkzeuge zum Gewindefräsen mit Interpolation
- DIES - Nicht einstellbare Schneideisen
- CENTER DRILLS - Zentrierbohrer und -werkzeuge
- TECHNICAL INFO - Abschnitt mit technischen Infos

GENERAL INDEX STRUCTURE

495	HAND TAPS Taps for manual use and for drilling machines		
507	EG (STI) Taps for Helical coil wire screw thread inserts		
531	SPECIAL THREADS, GAUGES Taps for special threads and simple measuring instruments for internal thread and bored hole diameters		
583	THREAD MILLS		
591	DIES		
603	CENTER DRILLS Center drills and centering tools		
623	TECHNICAL INFO		
752	COMPANY INFORMATION		

RUBRIQUES ET 15 MACRO-CHAPITRES

- INTRO - Comment lire le catalogue et rechercher des produits
- SP - Tarauds hélicoïdaux pour trous borgnes
- SL - Tarauds à hélice à gauche pour trous débouchants
- PO - Tarauds à entrée gun pour trous débouchants
- ST - Tarauds à goujures droites pour trous débouchants et borgnes
- ROLL - Tarauds par déformation matière pour trous borgnes et débouchants
- CARBIDE - Tarauds en carbure
- LONG - Tarauds série longue
- HAND TAPS - Série de tarauds à main et pour perceuses
- EG (STI) - Tarauds pour filets rapportés Helicoil
- SPECIAL THREADS, GAUGES - Tarauds pour filetages spéciaux et industries spécifiques, gamme pour outils de mesure
- THREAD MILLS - Outils pour filetage par interpolation
- DIES - Filières intégrales
- CENTER DRILLS - Forets et outils à centrer
- TECHNICAL INFO - Section technique

GUÍA CON 15 MACRO CAPÍTULOS

- INTRO - Cómo leer el catálogo y la búsqueda de productos
- SP - Machos helicoidales para agujeros ciegos
- SL - Machos con hélice izquierda para agujeros pasantes
- PO - Machos con entrada corregida para agujeros pasantes
- ST - Machos con ranuras rectas para agujeros pasantes y ciegos
- ROLL - Machos de laminación para agujeros ciegos y pasantes
- CARBIDE - Machos de metal duro
- LONG - Machos con mango largo
- HAND TAPS - Serie de machos de mano y para uso en taladros
- EG (STI) - Machos para roscas Helicoil
- SPECIAL THREADS, GAUGES - Machos para roscas especiales e industrias específicas, gama de herramientas de medición
- THREAD MILLS - Herramientas para roscado e interpolación
- DIES - Terrajas integrales
- CENTER DRILLS - Brocas y herramientas de centrado
- TECHNICAL INFO - Sección técnica

СХЕМА РУБРИКАЦИИ С 15 РАЗДЕЛАМИ

- INTRO - порядок чтения каталога и поиска продуктов
- SP - спиральные метчики для глухих отверстий
- SL - спиральные метчики с левой спиралью для сквозных отверстий
- PO - метчики с подточкой заборной части для сквозных отверстий
- ST - метчики с прямыми канавками для сквозных и глухих отверстий
- ROLL - накатные метчики для глухих и сквозных отверстий
- CARBIDE - твердосплавные метчики
- LONG - метчики с удлиненным хвостовиком
- HAND TAPS - метчики для ручного и механизированного нарезания резьбы
- EG (STI) - метчики для резьбы под проволочную вставку
- SPECIAL THREADS, GAUGES - метчики для специальных резьб и контрольный инструмент для внутренних резьб и диаметр предварительных отверстий
- THREAD MILLS - резьбофрезы
- DIES - плашки
- CENTER DRILLS - центровочные сверла
- TECHNICAL INFO - Техническая информация

SP

SL

PO

ST

ROLL

CARBIDE

LONG

HAND TAPS

EG (STI)

SPECIAL THREADS, GAUGES

THREAD MILLS

DIES

CENTER DRILLS

Technical info

Catalogue Structure

Ricerca prodotto
 Produktsuche
 Recherche des produits
 Búsqueda de productos
 Поиск продукта

SELECTION CHART STRUCTURE

Selection Chart

Intro

1

Z-PRO GP General Purpose

2

3

VUSP	VUSP E(1.5P)	AUSP G	AUSP Rp	AUSP Rc	HVSP	MHSP	SP
HSS-P COATING	HSS-P COATING	HSS-E COATING	HSS-E COATING	HSS-E COATING	HSS-E OX	HSS-Co COATING	HSS-E

4

	DIN	DIN	DIN	DIN	DIN	DIN	DIN	JIS	ANSI
M	81	83				89	93	95	152
MF	81	83				89	93	96	154
UNC/UNF						90		97	157 173
UNEF						90			158
G (BSP)			84					98	159
Rp (BSPP)				85					
Rc (BSPT)					87				
NPT									
NPTF									
NPSC, NPSM, NPSF									
BSW									159
EG(STI) M, MF, UNC/UNF									
Pg									
Tr									
S miniature									
Special threads									

Vc (m/min)

	★ 10÷25	★ 10÷25	★ 5÷10	★ 5÷10	★ ≤7	★ 3÷8	★ 10÷30	★ 5÷10
P1	★ 10÷25	★ 10÷25	★ 5÷10	★ 5÷10	★ ≤7	★ 3÷8	★ 10÷30	★ 5÷10
P2	★ 10÷25	★ 10÷25	★ 5÷10	★ 5÷10	★ ≤7	★ 3÷8	★ 10÷30	★ 5÷10
P3	★ 10÷25	★ 10÷25	★ 5÷10	★ 5÷10	★ ≤7	★ 3÷8	★ 10÷25	★ 5÷10
P4	★ 10÷20	★ 10÷20	☆ 5÷10	☆ 5÷10	☆ ≤5	☆ 3÷8	★ 10÷20	☆ 5÷8
P5							☆ 10÷15	
P6								
P7	★ 5÷15	★ 5÷15	★ ≤5	★ ≤5	★ ≤3	★ 3÷8		
P8								
M1	★ 5÷15	★ 5÷15	★ ≤5	★ ≤5	★ ≤3	★ 3÷8		
M2	★ 5÷10	★ 5÷10	★ ≤5	★ ≤5	★ ≤3	★ 3÷8		
M3								
K1								
K2	☆ 10÷20	☆ 10÷20	☆ ≤5	☆ ≤5	☆ ≤5			
K3								
K4								
N1	★ 10÷30	★ 10÷30	★ 5÷15	★ 5÷15	★ ≤10		☆ 5÷10	
N2	★ 10÷30	★ 10÷30	★ 5÷15	★ 5÷15	★ ≤10		☆ 5÷10	
N3	☆ 10÷25	☆ 10÷25	☆ 5÷15	☆ 5÷15	☆ ≤10		☆ 5÷10	
N4	☆ 10÷20	☆ 10÷20	☆ ≤5	☆ ≤5	☆ ≤5		☆ 5÷10	
N5								
S1 (<25 HRC)								
S2 (<35 HRC)								
S3 (35 ÷ 45 HRC)								
S5								
H (45 ÷ 55 HRC)								
H (55 ÷ 63 HRC)								

★ 1st choice ☆ suitable

5

6

7

Think threads with **YAMAWA**

SELECTION CHART STRUCTURE

 SELECTION CHART

At the beginning of each section the SELECTION CHART represents a kind of "technical index" providing information about the available range and application details.

- Choose suitable "Yamawa tap series" (Z-PRO, High Speed...) according to the customer application and expected performance requested.
- Based on "Yamawa tap series" choice, the SELECTION CHART provides the following details:

1. Yamawa tap series
2. product name
3. tap material and surface treatment
4. available range and catalogue page
5. machinable workpiece material groups
6. level of effectiveness (★, ☆)
7. suggested cutting speed range

 SELECTION CHART

Die SELECTION CHART am Anfang jedes Makrokapitels stellt eine Art "Technischer Index" dar, der Informationen über das verfügbare Sortiment und die technischen Daten für die Verwendung des Produkts liefert.

- Wählen Sie die "Yamawa-Gewindebohrer-Serie" (Z-PRO, HT, GENERAL PURPOSE, MULTI PURPOSE, MATERIAL SPECIFIC, HIGH SPEED) entsprechend der Kundenanwendung und den erwarteten Leistungen.
- Nach der Auswahl der "Yamawa-Gewindebohrer-Serie" liefert die SELECTION CHART-Methode folgende Informationen:

1. Yamawa-Gewindebohrer-Serie
2. Produktname
3. Material des Gewindebohrers und Oberflächenbehandlung
4. verfügbares Sortiment und Katalogseite
5. bearbeitbare Materialien
6. Wirkungsgrad (★, ☆)
7. empfohlene Schnittgeschwindigkeit

 SELECTION CHART

La TABLA DE SELECCIÓN que figura al principio de cada macrocapítulo representa una especie de "índice técnico" que proporciona información sobre la gama disponible y los datos técnicos para el uso del producto

- Elija la "serie de machos Yamawa" (Z-PRO, HT, OBJETIVO GENERAL, MULTIOBJETIVO, MATERIALES ESPECÍFICOS, ALTA VELOCIDAD) según la aplicación y las expectativas de rendimiento del cliente.
- Después de seleccionar la "serie de machos Yamawa", el método TABLA DE SELECCIÓN proporciona la siguiente información:

1. Serie de machos Yamawa
2. nombre del producto
3. material del macho y tratamiento superficial
4. gama disponible y página del catálogo
5. grupos de materiales mecanizables
6. nivel de eficacia (★, ☆)
7. velocidad de corte recomendada

 SELECTION CHART

La SELECTION CHART presente all'inizio di ogni macro capitolo, rappresenta una sorta di "indice tecnico" che fornisce informazioni relative alla gamma disponibile e i dati tecnici per l'utilizzo del prodotto.

- Scegli la "Yamawa tap series" (Z-PRO, High Speed...) a seconda dell'applicazione del cliente e delle aspettative in termini di performance.
- Scelta la "Yamawa tap series", il metodo SELECTION CHART fornisce le seguenti informazioni:

1. Yamawa tap series
2. nome del prodotto
3. materiale del maschio e trattamento superficiale
4. gamma disponibile e pag. catalogo
5. materiali lavorabili
6. livello di efficacia (★, ☆)
7. velocità di taglio consigliata

 SELECTION CHART

Le GRAPHIQUE DE SELECTION, présent au début de chaque macro-chapitre, représente une sorte d'*index technique* qui fournit des informations relative à la gamme disponible et les données techniques pour l'utilisation du produit.

- Choisir la "Yamawa tap series" (Z-PRO, HT, GENERAL PURPOSE, MULTI PURPOSE, MATERIAL SPECIFIC, HIGH SPEED) en fonction de l'application du client et des attentes en termes de performances.
- Après avoir choisi la "Yamawa tap series", la méthode GRAPHIQUE DE SÉLECTION fournit les informations suivantes:

1. Yamawa tap series
2. nom du produit
3. matériau du taraud et traitement superficiel
4. gamme disponible et page du catalogue
5. matériaux usinables
6. niveau d'efficacité (★, ☆)
7. vitesse de coupe recommandée

 SELECTION CHART

ТАБЛИЦА ВЫБОРА, приведенная в начале каждого макрораздела, представляет собой "технический указатель", содержащий информацию о доступном ассортименте и технические данные, необходимые для эксплуатации продукта

- Выбрать серию продуктов по классификации "Yamawa" (Z-PRO, HT, GENERAL PURPOSE, MULTI PURPOSE, MATERIAL SPECIFIC, HIGH SPEED) в соответствии с заявленными клиентом условиями эксплуатации и необходимыми эксплуатационными характеристиками.
- После выбора серии инструментов, в таблице выбора отображается следующая информация:

1. серия согласно классификации "Yamawa"
2. наименование
3. материал, из которого изготовлен метчик, и способ обработки его поверхности
4. доступный ассортимент и номер соответствующей страницы каталога
5. материалы, которые могут быть обработаны
6. уровень производительности (★, ☆)
7. рекомендуемая скорость резания

PRODUCT PAGE STRUCTURE

SP

SL

PO

ST

ROLL

CARBIDE

LONG

HAND TAPS

EG (STI)

SPECIAL THREADS, GAUGES

THREAD MILLS

DIES

CENTER DRILLS

Technical info

Spiral Fluted Taps

Intro
1

3
SP-VA

SP

4
MS Material Specific Series
Spiral Fluted Taps for Stainless Steel

DIN

2

HSS-E

OX



2.5P
THCHT

5

6
Recommended Tapping Speeds Depending On Materials

ISO	Vc (m/min)		ISO	Vc (m/min)	
P2	≤10	★	M1	≤10	★
P3	≤10	★			
P4	≤10	☆			
P7	≤10	★			

★ 1st choice ☆ suitable

7



8

FEATURES

Material specific for blind hole application.
Most suitable for stainless steel, steel and alloy steel.
OX treatment reduces welding troubles.

9

TYPE: EU_140

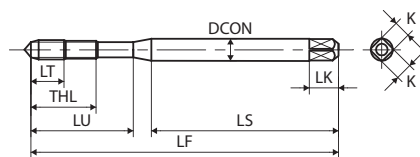

TYPE: EU_141

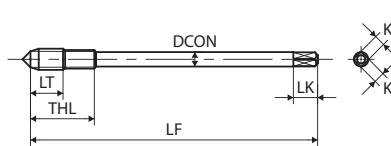

🇬🇧 PRODUCT PAGE

- Section title and thumb index
- Manufacturing standard
- Product name
- Series name
- Specification
- Application and Vc
- Image
- Features
- Drawing

🇩🇪 PRODUKTSEITE

- Kapitel- und Registerüberschrift
- Konstruktionsnorm
- Name des Produkts
- Produktreihe
- Spezifikationen
- Anwendung und Vc
- Abbildung und Vc
- Merkmale
- Zeichnung

🇪🇸 PÁGINA PRODUCTO

- Título del capítulo y guía
- Estándar de construcción
- Nombre del producto
- Serie de productos
- Especificaciones
- Aplicación y Vc
- Imagen
- Características
- Dibujo

🇮🇹 PAGINA PRODOTTO

- Titolo del capitolo e rubricatura
- Standard costruttivo
- Nome del prodotto
- Serie prodotto
- Specifiche tecniche
- Applicazione e Vc
- Immagine
- Caratteristiche
- Disegno

🇫🇷 PAGE PRODUIT

- Titre du chapitre et rubrique
- Standard de construction
- Nom du produit
- Série produit
- Spécifications
- Application et Vc
- Image
- Caractéristiques
- Dessin

🇷🇺 ИНФОРМАЦИЯ О ПРОДУКТЕ

- Заголовок раздела и схема рубрикации
- Конструкционный стандарт
- Наименование продукта
- Серия, к которой относится продукт
- Спецификация
- Возможные сферы применения и скорость резания
- Изображение продукта
- Характеристики
- Чертеж

PRODUCT PAGE STRUCTURE

M	TCTR (tolerance)	Hole Ø (mm)	Hole Ø (mm)	Code	THCHT (chamfer)	16								Type	Stock	
						LF (mm)	LT (mm)	THL (mm)	LU (mm)	LS (mm)	DCON (mm)	K (mm)	LK (mm)			NOF
DIN 371																
M2X0.4	IS02(6H)	1.6	1.65	SD2.0EAGEX	2.5P	45	4	8	-	32	2.8	2.1	5	2	140	●
M2.5X0.45	IS02(6H)	2.1	2.11	SD2.5FAGEX	2.5P	50	4	8	15	33	2.8	2.1	5	2	140	●
M3X0.5	IS02(6H)	2.5	2.56	SD3.0GAGEX	2.5P	56	5	9	18	34	3.5	2.7	6	2	140	●
	IS03(6G)	2.5	2.56	SD3.0GMGEX	2.5P	56	5	9	18	34	3.5	2.7	6	2	140	●
M4X0.7	IS02(6H)	3.3	3.38	SD4.0IAGEX	2.5P	63	7	13	21	38	4.5	3.4	6	3	140	●
	IS03(6G)	3.3	3.38	SD4.0IMGEX	2.5P	63	7	13	21	38	4.5	3.4	6	3	140	●
M5X0.8	IS02(6H)	4.2	4.28	SD5.0KAGEX	2.5P	70	9	14	25	39	6	4.9	8	3	140	●
	IS03(6G)	4.2	4.28	SD5.0KMGEX	2.5P	70	9	14	25	39	6	4.9	8	3	140	●
M6X1	IS02(6H)	5	5.09	SD6.0MAGEX	2.5P	80	11	15	30	45	6	4.9	8	3	140	●
	IS03(6G)	5	5.09	SD6.0MMGEX	2.5P	80	11	15	30	45	6	4.9	8	3	140	●
M8X1.25	IS02(6H)	6.8	6.85	SD8.0NAGEX	2.5P	90	-	12	35	47	8	6.2	9	3	025	●
	IS03(6G)	6.8	6.85	SD8.0NMGEX	2.5P	90	-	12	35	47	8	6.2	9	3	025	●
M10X1.5	IS02(6H)	8.5	8.6	SD0100AGEX	2.5P	100	-	13	39	52	10	8	11	3	025	●
	IS03(6G)	8.5	8.6	SD0100MGEX	2.5P	100	-	13	39	52	10	8	11	3	025	●
DIN 376																
M8X1.25	IS02(6H)	6.8	6.85	SG8.0NAGEX	2.5P	90	-	12	-	46	6	4.9	8	3	023	●
M10X1.5	IS02(6H)	8.5	8.6	SG0100AGEX	2.5P	100	-	13	-	51	7	5.5	8	3	023	●
M12X1.75	IS02(6H)	10.3	10.36	SG012PAGEX	2.5P	110	-	15	-	56	9	7	10	3	023	●
	IS03(6G)	10.3	10.36	SG012PMGEX	2.5P	110	-	15	-	56	9	7	10	3	023	●
M14X2	IS02(6H)	12	12.12	SG014QAGEX	2.5P	110	-	18	-	56	11	9	12	3	023	●
M16X2	IS02(6H)	14	14.12	SG016QAGEX	2.5P	110	-	18	-	56	12	9	12	3	023	●
M18X2.5	IS02(6H)	15.5	15.63	SG018RAGEX	2.5P	125	-	20	-	64	14	11	14	4	023	●
M20X2.5	IS02(6H)	17.5	17.63	SG020RAGEX	2.5P	140	-	20	-	71	16	12	15	4	023	●
M22X2.5	IS02(6H)	19.5	19.63	SG022RAGEX	2.5P	140	-	20	-	71	18	14.5	17	4	023	●

Oversized

● stock standard, ● check stock EU, ○ check stock JP, ▽ stock exhaustion

PRODUCT PAGE

- Size
- Tolerance
- Oversized tolerance
- Drill Ø and recommended hole Ø
- Product code
- Chamfer length
- General dimensions
- Drawing No.
- Stock rank

PAGINA PRODOTTO

- Misura
- Tolleranza
- Tolleranza maggiorata
- Ø Punta e Ø pre-foro consigliato
- Codice prodotto
- Lunghezza imbocco
- Dimensioni
- No. disegno
- Classificazione stock

PRODUKTSEITE

- Maße
- Toleranz
- Übermaß
- Ø Empfohlener Bohrer und Ø der Vorbohrung
- Produkt-Code
- Länge des Anschnitts
- Abmessungen
- Nr. Zeichnung
- Klassifizierung der Bestände

PAGE PRODUIT

- Mesure
- Tolérance
- Tolérance accrue
- Ø Foret et Ø avant-trou recommandé
- Code produit
- Longueur entrée
- Dimensions
- N° dessin
- Classification stock

PÁGINA PRODUCTO

- Medida
- Tolerancia
- Tolerancia sobredimensionada
- Ø Broca Ø agujero previo recomendados
- Código del producto
- Longitud de la entrada
- Dimensiones
- Nº dibujo
- Clasificación de stock

ИНФОРМАЦИЯ О ПРОДУКТЕ

- Размер
- Допуск
- Расширенный допуск
- Рекомендованный тип сверла и диаметр отверстия под нарезание резьбы
- Код продукта
- Длина заборной части
- Размеры
- Номер чертежа
- Наличие на складе

Product Search System

🇮🇹 Ricerca prodotto 🇪🇸 Productosuche 🇫🇷 Recherche des produits 🇵🇸 Búsqueda de productos 🇷🇺 Поиск продукта

Intro

PRODUCT SEARCH BY APPLICATION AND SYSTEM CHART

SP

SL

1

System Chart Index by ISO 513 Classification

Intro	MATERIALS	
SP	P1	<ul style="list-style-type: none"> Free cutting steel and structural steel Acciai automatici e acciai strutturali Automatenstähle und Baustähle
SL	P2	<ul style="list-style-type: none"> Carbon steel and low alloy steel Acciai al carbonio e acciai basso legati Kohlenstoff-Stähle und niedriglegierte Stähle
PO	P3	<ul style="list-style-type: none"> Medium alloy steel and heat treated steel Acciai medio legati e acciai di bonifica Mittellegierte Stähle und Vergütungsstähle
ST	P4	<ul style="list-style-type: none"> High alloy steel Acciai alto legati Hochlegierte Stähle
ROLL	P5	<ul style="list-style-type: none"> Tool steel Acciai per utensili Werkzeugstähle
ROLL	P6	<ul style="list-style-type: none"> High tensile strength steel Acciai ad alta resistenza HSLA-Stähle
CARBIDE	P7	<ul style="list-style-type: none"> Ferritic - Martensitic stainless steel Acciai inossidabili ferritici e martensitici Ferritico-Martensitische Stähle
LONG	P8	<ul style="list-style-type: none"> PH stainless steel Acciai inossidabili PH - durenti per precipitazione Ausscheidungshärtbare Edelstähle
HAND TAPS	M1	<ul style="list-style-type: none"> Austenitic stainless steel (good machinability) Acciai inossidabili austenitici (buona lavorabilità) Austenitische Edelstahl (niedriglegiert)
LONG	M2	<ul style="list-style-type: none"> Austenitic stainless steel (medium machinability) and Duplex Acciai inossidabili austenitici (media lavorabilità) e Duplex Austenitische Edelstahl (niedriglegiert)
EG (STI)	M3	<ul style="list-style-type: none"> Super austenitic stainless steel and super Duplex Acciai inossidabili austenitici (media lavorabilità) e Duplex Austenitische Edelstahl (mittel-legiert) und Duplex
SPECIAL		

System Chart Index by ISO 513 Classification

DIN	AISI-ASTM	TRADE MARK	SYSTEM CHART		Intro			
St 37-5 S 15 9 SMin 28	A573 Grade 58 1015 1213	AVP	26	27	28-29	42	42	P1
C 45 CK 60 16 MnCr 5 20 MnCr 5	1045 1064 5115 5120	-	26	27	28-29	42	42	P2
35 CrMo 4 41 Cr 4 25 CrMo 4 42 CrMo 4	4135 5140 4130 4142, 4140	-	26	27	28-29	42	42	P3
CK 67 C 105 W1 100 MnCrW 4 100 Cr 6	1070 W1 O1 52100	-	26	27	28-29	42	42	P4
40 CrNiMo 7 X 38 CrNi 5 1 X 40 CrNiMoV 5 1 55 NiCrMoV 6	H11 H13 L6	ORVAR - W302	26	27	28-29	42	42	P5
40 NiCrMo 2 2	8640	HARDOX 400® TOOLCOX 44®	26	27	28-29	42	42	P6
X 6 Cr 13 X 6 Cr 17 X 20 Cr 13	403 430 420	-	26	27	28-29	42	42	P7
X 4 CrNiCuNb 16 4 X 5 CrNiCuNb 17 4	XM-12 630	15-5-PH 17-4-PH	26	27	28-29	42	42	P8
X 3 CrNi 18 10 X 10 CrNiS 18 9 X 2 CrNi 19 11	304 303 304 L	-	30-31	30-31	43	43	43	M1
X 5 CrNiMo 17 12 2 X 2 CrNiMo 18 14 3 X 10 CrNiMoTi 18 10	316 316 L 316 Ti	-	30-31	30-31	43	43	43	M2
X 2 CrNiMoN 25 7 4 X 2 NiCrMoCu 25 20 5 X 4 NiCrTi 25 15	F 53 904L 660	A286	30-31	30-31	43	43	43	M3

ST

ROLL

CARBIDE

LONG

HAND TAPS

EG (STI)

SPECIAL THREADS, GAUGES

THREAD MILLS

DIES

CENTER DRILLS

Technical info

System Chart - ISO M

🇮🇹 Grafici applicativi 🇪🇸 Anwendungstabellen 🇫🇷 Graphiques d'application 🇵🇸 Gráficos de aplicación 🇷🇺 Диаграммы области применения

Intro

CUTTING TAPS

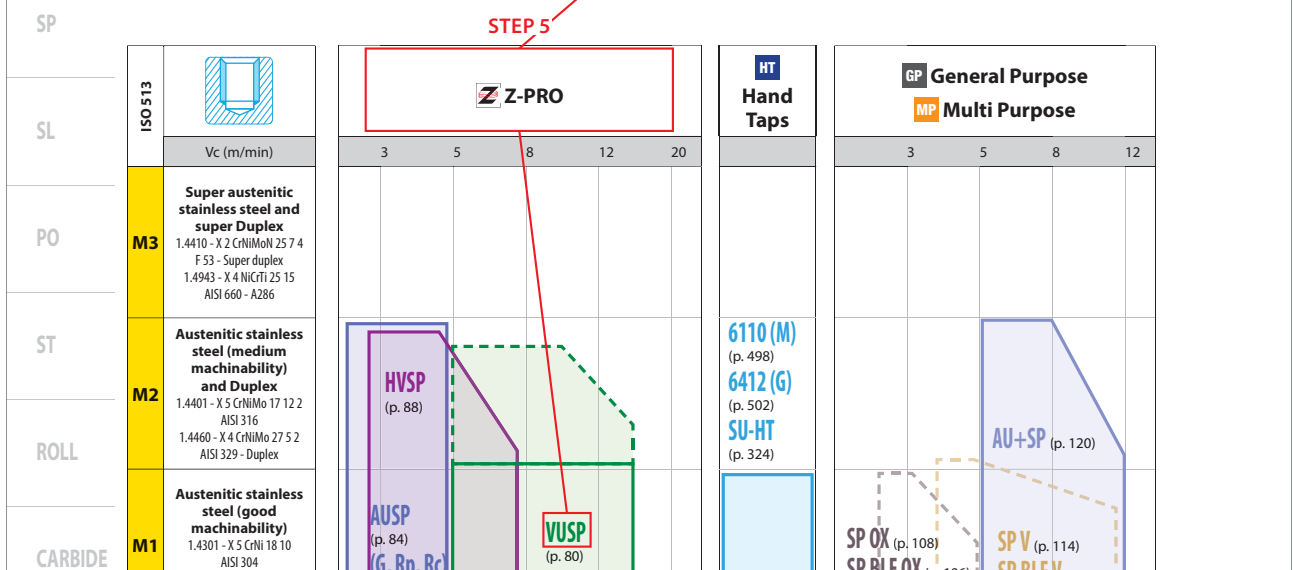

PRODUCT SEARCH BY APPLICATION AND SYSTEM CHART

🇬🇧 APPLICATION AND SYSTEM CHART

System Chart, 5 easy steps, to the definition of the most suitable tap for a specific application (workpiece material, blind or through hole, cutting or forming taps...), within the framework of the "Yamawa tap series" classification system (see page 7)

- STEP 1 identify the workpiece material group (ISO513) at page 21 (e.g. austenitic stainless steel - group M1)
- STEP 2 choose cutting or forming tap (e.g. cutting tap)
- STEP 3 choose tap for blind or through hole (e.g. blind hole)
- STEP 4 proceed to the relevant System Chart
- STEP 5 select the most suitable tap based on "Yamawa tap series" classification and cutting speed(e.g. Z-PRO series - VUSP suitable for Vc 5-12m/min)

🇩🇪 ANWENDUNG UND SYSTEM CHART

Die System Chart-Methode liefert je nach Kundenanwendung (bearbeitetes Material, Sack- oder Durchgangsloch, Schneiden oder Formen...) in 5 einfachen Schritten die Angabe des geeigneten Gewindebohrers und die Klassifizierung der Yamawa Gewindebohrer-Serie (siehe Seite 7).

- SCHRITT 1 Identifizierung der zu bearbeitenden Werkstoffgruppe (ISO513) Seite 21 (z.B. austenitischer rostfreier Stahl - Gruppe M1)
- SCHRITT 2 Auswahl zwischen Gewindebohrer oder Gewindeformer (z.B. Gewindebohrer)
- SCHRITT 3 Auswahl zwischen Gewindebohrer für Sackloch oder Durchgangsloch (z.B. Sackloch)
- SCHRITT 4 zum resultierenden System Chart gehen
- SCHRITT 5 den geeigneten Gewindebohrer entsprechend der Klassifizierung "Yamawa-Gewindebohrer-Serie" und der Schnittgeschwindigkeit auswählen (z.B. Z-PRO-Serie - VUSP geeignet für Vc 5-12 m/min)

🇪🇸 APLICACIÓN Y SYSTEM CHART

El método System Chart proporciona en 5 pasos sencillos la indicación del macho más adecuado según la aplicación del cliente (material, agujero ciego o pasante, corte o laminación...) y la clasificación de la serie de machos Yamawa (véase página 7)

- PASO 1 identificar el material (ISO513) que se va a mecanizar página 21 (por ejemplo, acero inoxidable austenítico - grupo M1)
- PASO 2 elegir si usar macho de corte o de laminación (por ejemplo, el macho de corte)
- PASO 3 elegir el macho según sea para agujero ciego o para agujero pasante (por ejemplo, agujero ciego)
- PASO 4 ir a la System Chart correspondiente
- PASO 5 seleccionar el macho adecuado según la clasificación "serie de machos Yamawa" y la velocidad de corte (por ejemplo, serie Z-PRO - VUSP adecuado para Vc 5-12 m/min)

🇮🇹 APPLICAZIONE E SYSTEM CHART

Il metodo System Chart fornisce in 5 semplici passaggi, l'indicazione del maschio adatto in base all'applicazione del cliente (materiale lavorato, foro cieco o passante, asportazione o deformazione...) e alla classificazione delle Yamawa tap series (vedi pag. 7)

- STEP 1 identificare a pagina 21 il gruppo materiale (ISO513) da lavorare (es. acciaio inossidabile austenitico - gruppo M1)
- STEP 2 scegliere se utilizzare maschio ad asportazione o a rullare (es. maschio per asportazione)
- STEP 3 scegliere se maschio per foro cieco o per foro passante (es. foro cieco)
- STEP 4 andare alla System Chart risultante
- STEP 5 selezionare il maschio adatto in base alla classificazione "Yamawa tap series" e alla velocità di taglio(es. Z-PRO series - VUSP adatto per Vc 5-12m/min)

🇫🇷 TABLEAU D'APPLICATION ET SYSTÈME CHART

La méthode System Chart fournit, en 5 étapes simples, l'indication du taraud approprié en fonction de l'application du client (matériau usiné, trou borgne ou débouchant, enlèvement ou déformation, etc.) et de la classification des Yamawa tap series (voir page 7).

- ÉTAPE 1 identifier le groupe du matériau (ISO513) à usiner page 21(par exemple acier inoxydable austénitique - groupe M1)
- ÉTAPE 2 choisir entre un taraud par enlèvement de matière ou par déformation de matière(par exemple, taraud d'enlèvement)
- ÉTAPE 3 choisir d'utiliser un taraud pour trou borgne ou pour trou débouchant (par exemple, trou borgne)
- ÉTAPE 4 consulter le System Chart correspondant
- ÉTAPE 5 sélectionner le taraud approprié en fonction de la classification "Yamawa tap series" et de la vitesse de coupe (par exemple, Z-PRO series - VUSP adapté pour Vc 5-12 m/min.)

🇷🇺 ПОИСК ПО ОБЛАСТИ ИСПОЛЬЗОВАНИЯ И БЛОК-СХЕМА

Блок-схема позволяет с помощью 5 простых действий выбрать наиболее подходящий метчик в соответствии с областью использования, определяемой клиентом (обрабатываемый материал, глухое или сквозное отверстие, применение нарезки или накатки и т. д.), и применяемой компанией Yamawa классификацией (см. стр. 7)

- ШАГ 1 определить группу (по ISO 513), к которой относится обрабатываемый материал стр. 21 (напр., аустенитная нержавеющая сталь - группа M1)
- ШАГ 2 выбрать тип метчика - режущий или раскатывающий (напр., режущий)
- ШАГ 3 выбрать тип отверстия - глухое или сквозное (например, глухое)
- ШАГ 4 перейти в соответствующий блок
- ШАГ 5 выбрать подходящий метчик согласно классификации Yamawa и скорости резания (например серия Z-PRO - метчики - VUSP - предназначены для скоростей резания Vc = 5-12 м/мин)

SP

SL

PO

ST

ROLL

CARBIDE

LONG

HAND
TAPS

EG (STI)

SPECIAL
THREADS,
GAUGESTHREAD
MILLS

DIES

CENTER
DRILLSTechnical
info

PRODUCT SEARCH BY TYPE OF THREAD

SP

2

SL

PO

ST

ROLL

CARBIDE

LONG

HAND TAPS

EG (STI)

SPECIAL THREADS, GAUGES

THREAD MILLS

DIES

CENTER DRILLS

Technical info

LineUp arranged by type of thread																			
Intro	M																		
SP	M																		
SL	SP - Spiral fluted taps																		
PO	<table border="1"> <tr><td>Z-PRO</td><td></td><td>DIN</td><td>80</td></tr> <tr><td>VUSP</td><td></td><td>JIS</td><td></td></tr> <tr><td>M 3 ÷ 16</td><td>HSSP Spiral Fluted Taps, Coated</td><td>ANSI</td><td></td></tr> <tr><td></td><td></td><td>YMW</td><td></td></tr> </table>	Z-PRO		DIN	80	VUSP		JIS		M 3 ÷ 16	HSSP Spiral Fluted Taps, Coated	ANSI				YMW			
Z-PRO		DIN	80																
VUSP		JIS																	
M 3 ÷ 16	HSSP Spiral Fluted Taps, Coated	ANSI																	
		YMW																	
ST	<table border="1"> <tr><td>Z-PRO</td><td></td><td>DIN</td><td>82</td></tr> <tr><td>VUSP E(1.5P)</td><td></td><td>JIS</td><td></td></tr> <tr><td>M 3 ÷ 16</td><td>HSSP Spiral Fluted Taps 1.5P, Coated</td><td>ANSI</td><td></td></tr> <tr><td></td><td></td><td>YMW</td><td></td></tr> </table>	Z-PRO		DIN	82	VUSP E(1.5P)		JIS		M 3 ÷ 16	HSSP Spiral Fluted Taps 1.5P, Coated	ANSI				YMW			
Z-PRO		DIN	82																
VUSP E(1.5P)		JIS																	
M 3 ÷ 16	HSSP Spiral Fluted Taps 1.5P, Coated	ANSI																	
		YMW																	
ROLL	<table border="1"> <tr><td>Z-PRO</td><td></td><td>DIN</td><td>88</td></tr> <tr><td>HVSP</td><td></td><td>JIS</td><td></td></tr> <tr><td>M 12 ÷ 48</td><td>Spiral Fluted Taps for large forged parts in the heavy metalworking industry</td><td>ANSI</td><td></td></tr> <tr><td></td><td></td><td>YMW</td><td></td></tr> </table>	Z-PRO		DIN	88	HVSP		JIS		M 12 ÷ 48	Spiral Fluted Taps for large forged parts in the heavy metalworking industry	ANSI				YMW			
Z-PRO		DIN	88																
HVSP		JIS																	
M 12 ÷ 48	Spiral Fluted Taps for large forged parts in the heavy metalworking industry	ANSI																	
		YMW																	
CARBIDE	<table border="1"> <tr><td>Z-PRO</td><td></td><td>DIN</td><td>92</td></tr> <tr><td>MHSP</td><td></td><td>JIS</td><td></td></tr> <tr><td>M 8 ÷ 16</td><td>Spiral Fluted Taps for Carbon Steel of Medium Hardness, Coated</td><td>ANSI</td><td></td></tr> <tr><td></td><td></td><td>YMW</td><td></td></tr> </table>	Z-PRO		DIN	92	MHSP		JIS		M 8 ÷ 16	Spiral Fluted Taps for Carbon Steel of Medium Hardness, Coated	ANSI				YMW			
Z-PRO		DIN	92																
MHSP		JIS																	
M 8 ÷ 16	Spiral Fluted Taps for Carbon Steel of Medium Hardness, Coated	ANSI																	
		YMW																	
LONG	<table border="1"> <tr><td>GENERAL PURPOSE</td><td></td><td>DIN</td><td>94</td></tr> <tr><td>SP</td><td></td><td>JIS</td><td>152</td></tr> <tr><td>M 1.2 ÷ 64</td><td>Spiral Fluted Taps</td><td>ANSI</td><td></td></tr> <tr><td></td><td></td><td>YMW</td><td></td></tr> </table>	GENERAL PURPOSE		DIN	94	SP		JIS	152	M 1.2 ÷ 64	Spiral Fluted Taps	ANSI				YMW			
GENERAL PURPOSE		DIN	94																
SP		JIS	152																
M 1.2 ÷ 64	Spiral Fluted Taps	ANSI																	
		YMW																	
HAND TAPS	<table border="1"> <tr><td>GENERAL PURPOSE</td><td></td><td>DIN</td><td>94</td></tr> <tr><td>SP ISO3(6G)</td><td></td><td>JIS</td><td></td></tr> <tr><td>M 1.2 ÷ 64</td><td>Spiral Fluted Taps</td><td>ANSI</td><td></td></tr> <tr><td></td><td></td><td>YMW</td><td></td></tr> </table>	GENERAL PURPOSE		DIN	94	SP ISO3(6G)		JIS		M 1.2 ÷ 64	Spiral Fluted Taps	ANSI				YMW			
GENERAL PURPOSE		DIN	94																
SP ISO3(6G)		JIS																	
M 1.2 ÷ 64	Spiral Fluted Taps	ANSI																	
		YMW																	
EG (STI)	<table border="1"> <tr><td>GENERAL PURPOSE</td><td></td><td>DIN</td><td>94</td></tr> <tr><td>SP ISO2(6H)+50</td><td></td><td>JIS</td><td></td></tr> <tr><td>M 1.2 ÷ 64</td><td>Spiral Fluted Taps</td><td>ANSI</td><td></td></tr> <tr><td></td><td></td><td>YMW</td><td></td></tr> </table>	GENERAL PURPOSE		DIN	94	SP ISO2(6H)+50		JIS		M 1.2 ÷ 64	Spiral Fluted Taps	ANSI				YMW			
GENERAL PURPOSE		DIN	94																
SP ISO2(6H)+50		JIS																	
M 1.2 ÷ 64	Spiral Fluted Taps	ANSI																	
		YMW																	
SPECIAL THREADS, GAUGES	<table border="1"> <tr><td>GENERAL PURPOSE</td><td></td><td>DIN</td><td>94</td></tr> <tr><td>SP ISO2(6H)+100</td><td></td><td>JIS</td><td></td></tr> <tr><td>M 1.2 ÷ 64</td><td>Spiral Fluted Taps</td><td>ANSI</td><td></td></tr> <tr><td></td><td></td><td>YMW</td><td></td></tr> </table>	GENERAL PURPOSE		DIN	94	SP ISO2(6H)+100		JIS		M 1.2 ÷ 64	Spiral Fluted Taps	ANSI				YMW			
GENERAL PURPOSE		DIN	94																
SP ISO2(6H)+100		JIS																	
M 1.2 ÷ 64	Spiral Fluted Taps	ANSI																	
		YMW																	
THREAD MILLS	<table border="1"> <tr><td>GENERAL PURPOSE</td><td></td><td>DIN</td><td>100</td></tr> <tr><td>SP-BLF</td><td></td><td>JIS</td><td></td></tr> <tr><td>M 3 ÷ 24</td><td>Spiral Fluted Taps, Deep Hole Use</td><td>ANSI</td><td></td></tr> <tr><td></td><td></td><td>YMW</td><td></td></tr> </table>	GENERAL PURPOSE		DIN	100	SP-BLF		JIS		M 3 ÷ 24	Spiral Fluted Taps, Deep Hole Use	ANSI				YMW			
GENERAL PURPOSE		DIN	100																
SP-BLF		JIS																	
M 3 ÷ 24	Spiral Fluted Taps, Deep Hole Use	ANSI																	
		YMW																	
DIES	<table border="1"> <tr><td>GENERAL PURPOSE</td><td></td><td>DIN</td><td></td></tr> <tr><td>SP 1.5P</td><td></td><td>JIS</td><td>160</td></tr> <tr><td>M 1.2 ÷ 16</td><td>Spiral Fluted Taps 1.5P</td><td>ANSI</td><td></td></tr> <tr><td></td><td></td><td>YMW</td><td></td></tr> </table>	GENERAL PURPOSE		DIN		SP 1.5P		JIS	160	M 1.2 ÷ 16	Spiral Fluted Taps 1.5P	ANSI				YMW			
GENERAL PURPOSE		DIN																	
SP 1.5P		JIS	160																
M 1.2 ÷ 16	Spiral Fluted Taps 1.5P	ANSI																	
		YMW																	
CENTER DRILLS	<table border="1"> <tr><td>GENERAL PURPOSE</td><td></td><td>DIN</td><td></td></tr> <tr><td>SP 1.5P</td><td></td><td>JIS</td><td>160</td></tr> <tr><td>M 1.2 ÷ 16</td><td>Spiral Fluted Taps 1.5P</td><td>ANSI</td><td></td></tr> <tr><td></td><td></td><td>YMW</td><td></td></tr> </table>	GENERAL PURPOSE		DIN		SP 1.5P		JIS	160	M 1.2 ÷ 16	Spiral Fluted Taps 1.5P	ANSI				YMW			
GENERAL PURPOSE		DIN																	
SP 1.5P		JIS	160																
M 1.2 ÷ 16	Spiral Fluted Taps 1.5P	ANSI																	
		YMW																	

LINE-UP ARRANGED BY TYPE OF THREAD

The Line-up arranged by type of thread (page 45) provides the full list of products available for each different type of thread (M, MF, UNC, UNF...)

INDICE PRODOTTO/TIPO FILETTATURA

L'indice "Line-up arranged on type of thread" (pag. 45) rappresenta l'elenco di tutti i prodotti disponibili nel catalogo, suddivisi per i diversi tipi di filettatura (M, MF, UNC, UNF...)

AUFSTELLUNG NACH GEWINDETYP

Der Index "Aufstellung nach Gewindetyp" (Seite 45) stellt die Liste aller im Katalog verfügbaren Produkte dar, unterteilt nach den verschiedenen Gewindetypen (M, MF, UNC, UNF...)

INDEX PRODUITS / FILETAGES

L'index «Produits/Filetages» (page 45) représente la liste de tous les produits disponibles dans le catalogue, subdivisés par type de filetage (M, MF, UNC, UNF, etc.)

ÍNDICE POR TIPO DE ROSCA

El índice por tipo de rosca (pág. 45) muestra la lista de todos los productos disponibles en el catálogo, divididos por los diferentes tipos de rosca (M, MF, UNC, UNF...)

УКАЗАТЕЛЬ ПРОДУКТОВ ПО ТИПУ РЕЗЬБЫ





Указатель, составленный по типу резьбы (стр. 45), содержит список присутствующих в каталоге продуктов, сгруппированных по типу резьбы (M, MF, UNC, UNF и т. д.)

PRODUCT SEARCH BY TAP SIZE

3

27. Lineup arranged by size

Intro

	M					
SP	M1X0.25				J	J
	M1.1X0.25				J	J
	M1.2X0.25	J		J	J	J
SL	M1.4X0.3	J		D - J	J	J
	M1.6X0.35	J		D - J	J	J
	M1.7X0.35	J		J	J	J
	M1.8X0.35	J		J	J	J
PO	M2X0.4	D - J		D - J	D - J	D - J
	M2.2X0.45	D - J		D - J	J	J
	M2.3X0.4	J		D - J	J	J
ST	M2.5X0.45	D - J		D - J	D - J	D - J
	M2.6X0.45	D - J		D - J	J	J
	3M0.6	J		J	J	
	M3X0.5	D - J	D	D - J	D - J	D - J
	M3.5X0.6	D - J		D - J	J	D - J
ROLL	4M0.75	J		J	J	
	M4X0.7	D - J	D	D - J	D - J	D - J
	M4.5X0.75	J		J	J	
	5M0.9	J		J	J	
CARBIDE	M5X0.8	D - J	D	D - J	D - J	D - J
	M5.5X0.9	J		J	J	
	M6X1	D - J	D	D - J	D - J	D - J
	M7X1	D - J		D - J	J	J
	M8X1.25	D - J	D	D - J	D - J	D - J
LONG	M9X1.25	D - J		D - J	J	
	M10X1.5	D - J	D	D - J	D - J	D - J
	M11X1.5	D - J		D - J	J	
	M12X1.75	D - J	D	D - J	D - J	D - J
HAND TAPS	M14X2	D - J	D	D - J	D - J	D - J
	M16X2	D - J	D	D - J	D - J	D - J
	M18X2.5	D - J	D	D - J	D - J	
	M20X2.5	D - J	D	D - J	D - J	J
EG (STI)	M22X2.5	D - J		D - J	D - J	
	M24X3	D - J		D - J	D - J	
	M27X3	D - J		D - J	J	
	M30X3.5	D - J		D - J	J	
SPECIAL THREADS, GAUGES	M33X3.5	D - J		D - J	J	
	M36X4	D - J		D - J	J	
	M39X4	D - J		D - J	J	
	M42X4.5	D - J		D - J	J	
	M45X4.5	D - J		D - J	J	
THREAD MILLS	M48X5	D - J		D - J	J	
	M52X5	J		J		
	M56X5.5	J		J		
	M60X5.5	J		J		
DIES	M64X6	J		J		
	M68X6			J		
	M70X6			J		
	M72X6			J		
	M76X6			J		
	M80X6			J		
CENTER DRILLS	M85X6			J		
	M90X6			J		
	M95X6			J		
	M100X6			J		

Technical info

D = available in DIN standard, J = available in JIS standard, A = available in ANSI standard

 LINE-UP ARRANGED BY SIZE

The Line-up arranged by size (page 724 of technical info) provides the list of tap sizes available in each catalogue section (SP, SL, PO...).

 INDICE PRODOTTO/DIMENSIONE FILETTO

L'indice "Line-up arranged by size" (pag. 724 della technical info) rappresenta l'elenco di tutte le dimensioni di maschi disponibili in ogni sezione (SP, SL, PO...) del catalogo.

 AUFSTELLUNG NACH GRÖSSE

Der Index "Aufstellung nach Größe" (S. 724 des Abschnittes technische Informationen) stellt die Liste aller im Katalog verfügbaren Größen von Gewindebohrern dar.

 INDEX DIMENSIONS / PRODUITS

L'index «Dimensions/Produits» (voir page 724 de l'Information Technique) représente la liste de toutes les dimensions de tarauds disponibles dans le catalogue.

 ÍNDICE POR TAMAÑO

El índice de productos por tamaño (pág. 724 de la información técnica) muestra la lista de todos los tamaños de machos disponibles en el catálogo.

 УКАЗАТЕЛЬ ПРОДУКТОВ ПО РАЗМЕРУ

Указатель, составленный по размеру резьбы (стр. 724 технического раздела), содержит список присутствующих в каталоге метчиков (SP, SL, PO...), сгруппированных по размеру.

SP

SL

PO

ST

ROLL

CARBIDE

LONG

HAND TAPS

EG (STI)

SPECIAL THREADS, GAUGES

THREAD MILLS

DIES

CENTER DRILLS

Technical info

Hardness conversion table

 Durezza
  Härte
  Dureté
  Durezza
  Твердость

Intro

SP	ROCKWELL C SCALE HARDNESS	VICKERS HARDNESS	BRINELL HARDNESS		ROCKWELL HARDNESS*2			ROCKWELL SUPERFICIAL HARDNESS			SHORE HARDNESS	TENSILE STRENGTH MPA*1	ROCKWELL C SCALE HARDNESS*2
			STANDARD BALL	TUNGSTEN CARBIDE BALL	A SCALE	B SCALE	D SCALE	15-N SCALE	30-N SCALE	45-N SCALE			
			HRC	HV	HB	HRA	HRB	HRD	HS15N	HS30N			
	68	940	-	-	85.6	-	76.9	93.2	84.4	75.4	97	-	68
	67	900	-	-	85.0	-	76.1	92.9	83.6	74.2	95	-	67
SL	66	865	-	-	84.5	-	75.4	92.5	82.8	73.3	92	-	66
	65	832	-	(739)	83.9	-	74.5	92.2	81.9	72.0	91	-	65
	64	800	-	(722)	83.4	-	73.8	91.8	81.1	71.0	88	-	64
	63	772	-	(705)	82.8	-	73.0	91.4	80.1	69.9	87	-	63
	62	746	-	(688)	82.3	-	72.2	91.1	79.3	68.8	85	-	62
PO	61	720	-	(670)	81.8	-	71.5	90.7	78.4	67.7	83	-	61
	60	697	-	(654)	81.2	-	70.7	90.2	77.5	66.7	81	-	60
	59	674	-	(634)	80.7	-	69.9	89.8	76.6	65.5	80	-	59
	58	653	-	615	80.1	-	69.2	89.3	75.7	64.3	78	-	58
ST	57	633	-	595	79.6	-	68.5	88.9	74.8	63.2	76	-	57
	56	613	-	577	79.0	-	67.7	88.3	73.9	62.0	75	-	56
	55	595	-	560	78.5	-	66.9	87.9	73.0	60.9	74	2075	55
	54	577	-	543	78.0	-	66.1	87.4	72.0	59.8	72	2015	54
	53	560	-	525	77.4	-	65.4	86.9	71.2	58.6	71	1950	53
ROLL	52	544	(500)	512	76.8	-	64.6	86.4	70.2	57.4	69	1880	52
	51	528	(487)	496	76.3	-	63.8	85.9	69.4	56.1	68	1820	51
	50	513	(475)	481	75.9	-	63.1	85.5	68.5	55.0	67	1760	50
	49	498	(464)	469	75.2	-	62.1	85.0	67.6	53.8	66	1695	49
CARBIDE	48	484	451	455	74.7	-	61.4	84.5	66.7	52.5	64	1635	48
	47	471	442	443	74.1	-	60.8	83.9	65.8	51.4	63	1580	47
	46	458	432	432	73.6	-	60.0	83.5	64.8	50.3	62	1530	46
	45	446	421	421	73.1	-	59.2	83.0	64.0	49.0	60	1480	45
	44	434	409	409	72.5	-	58.5	82.5	63.1	47.8	58	1435	44
	43	423	400	400	72.0	-	57.7	82.0	62.2	46.7	57	1385	43
LONG	42	412	390	390	71.5	-	56.9	81.5	61.3	45.5	56	1340	42
	41	402	381	381	70.9	-	56.2	80.9	60.4	44.3	55	1295	41
	40	392	371	371	70.4	-	55.4	80.4	59.5	43.1	54	1250	40
	39	382	362	362	69.9	-	54.6	79.9	58.6	41.9	52	1215	39
HAND TAPS	38	372	353	353	69.4	-	53.8	79.4	57.7	40.8	51	1180	38
	37	363	344	344	68.9	-	53.1	78.8	56.8	39.6	50	1160	37
	36	354	336	336	68.4	(109.0)	52.3	78.3	55.9	38.4	49	1115	36
	35	345	327	327	67.9	(108.5)	51.5	77.7	55.0	37.2	48	1080	35
	34	336	319	319	67.4	(108.0)	50.8	77.2	54.2	36.1	47	1055	34
EG (STI)	33	327	311	311	66.8	(107.5)	50.0	76.6	53.3	34.9	46	1025	33
	32	318	301	301	66.3	(107.0)	49.2	76.1	52.1	33.7	44	1000	32
	31	310	294	294	65.8	(106.0)	48.4	75.6	51.3	32.5	43	980	31
	30	302	286	286	65.3	(105.5)	47.7	75.0	50.4	31.3	42	950	30
SPECIAL THREADS, GAUGES	29	294	279	279	64.7	(104.5)	47.0	74.5	49.5	30.1	41	930	29
	28	286	271	271	64.3	(104.0)	46.1	73.9	48.6	28.9	41	910	28
	27	279	264	264	63.8	(103.0)	45.2	73.3	47.7	27.8	40	880	27
	26	272	258	258	63.3	(102.5)	44.6	72.8	46.8	26.7	38	860	26
	25	266	253	253	62.8	(101.5)	43.8	72.2	45.9	25.5	38	840	25
THREAD MILLS	24	260	247	247	62.4	(101.0)	43.1	71.6	45.0	24.3	37	825	24
	23	254	243	243	62.0	100.0	42.1	71.0	44.0	23.1	36	805	23
	22	248	237	237	61.5	99.0	41.6	70.5	43.2	22.0	35	785	22
	21	243	231	231	61.0	98.5	40.9	69.9	42.3	20.7	35	770	21
	20	238	226	226	60.5	97.8	40.1	69.4	41.5	19.6	34	760	20
DIES	18	230	219	219	-	96.7	-	-	-	-	33	730	(18)
	(16)	222	212	212	-	95.5	-	-	-	-	32	705	(16)
	(14)	213	203	203	-	93.9	-	-	-	-	31	675	(14)
	(12)	204	194	194	-	92.3	-	-	-	-	29	650	(12)
	(10)	196	187	187	-	90.7	-	-	-	-	28	620	(10)
CENTER DRILLS	(8)	188	179	179	-	89.5	-	-	-	-	27	600	8
	(6)	180	171	171	-	87.1	-	-	-	-	26	580	(6)
	(4)	173	165	165	-	85.5	-	-	-	-	25	550	(4)
	(2)	166	158	158	-	83.5	-	-	-	-	24	530	(2)
	(0)	160	152	152	-	81.7	-	-	-	-	24	515	(0)

*1 : 1MPa=1N/mm2

*2 : In the table above, numbers in brackets are only provide for reference.

This table is abstracted from SAE J 417.

Technical info

SYSTEM CHART BY ISO 513 CLASSIFICATION

System Chart Index by ISO 513 Classification

Intro

SP

MATERIALS

HARDNESS/Rm

P1	<ul style="list-style-type: none"> Free cutting steel and structural steel Acciai automatici e acciai strutturali Automatenstähle und Baustähle 	<ul style="list-style-type: none"> Aciers pour décolletage et aciers structurels Aceros de fácil mecanización y aceros de construcción Автоматные и конструкционные стали 	< 500 N/mm ²
P2	<ul style="list-style-type: none"> Carbon steel and low alloy steel Acciai al carbonio e acciai basso legati Kohlenstoff-Stähle und niedriglegierte Stähle 	<ul style="list-style-type: none"> Aciers au carbone et aciers faiblement alliés Aceros al carbono y aceros de baja aleación Углеродистые и низколегированные стали 	500 ÷ 700 N/mm ²
P3	<ul style="list-style-type: none"> Medium alloy steel and heat treated steel Acciai medio legati e acciai di bonifica Mittellegierte Stähle und Vergütungsstähle 	<ul style="list-style-type: none"> Aciers moyennement alliés et aciers trempés et recuits Aceros de media aleación y aceros bonificados Среднелегированные и отожженные стали 	600 ÷ 800 N/mm ²
P4	<ul style="list-style-type: none"> High alloy steel Acciai alto legati Hochlegierte Stähle 	<ul style="list-style-type: none"> Aciers fortement alliés Aceros de alta aleación Высоколегированные стали 	800 ÷ 1000 N/mm ²
P5	<ul style="list-style-type: none"> Tool steel Acciai per utensili Werkzeugstähle 	<ul style="list-style-type: none"> Aciers pour outils Aceros para herramientas Инструментальные стали 	900 ÷ 1200 N/mm ²
P6	<ul style="list-style-type: none"> High tensile strength steel Acciai ad alta resistenza HSLA-Stähle 	<ul style="list-style-type: none"> Aciers haute résistance Aceros de alta resistencia Высокопрочная сталь 	1200 ÷ 1480 N/mm ² 38 ÷ 45 HRC
P7	<ul style="list-style-type: none"> Ferritic - Martensitic stainless steel Acciai inossidabili ferritici e martensitici Ferritische-Martensitische Stähle 	<ul style="list-style-type: none"> Aciers inoxydables ferritiques-martensitiques Aceros inoxidables ferríticos-martensíticos Ферритно-мартенситная нержавеющая сталь 	
P8	<ul style="list-style-type: none"> PH stainless steel Acciai inossidabili PH - indurenti per precipitazione Ausscheidungshartbare Edelstähle 	<ul style="list-style-type: none"> Aciers inoxydables à durcissement par précipitation Aceros inoxidables PH Дисперсионно-твердеющая нержавеющая сталь 	
M1	<ul style="list-style-type: none"> Austenitic stainless steel (good machinability) Acciai inossidabili austenitici (buona lavorabilità) Austenitische Edelstähle (niedriglegiert) 	<ul style="list-style-type: none"> Aciers inoxydables austénitiques (faiblement allié) Aceros inoxidables Austeníticos (fácil mecanizado) Аустенитная нержавеющая сталь 	
M2	<ul style="list-style-type: none"> Austenitic stainless steel (medium machinability) and Duplex Acciai inossidabili austenitici (media lavorabilità) e Duplex Austenitische Edelstähle (mittel-legiert) und Duplex 	<ul style="list-style-type: none"> Aciers inoxydables austénitiques (moyennement allié) et Duplex Aceros inoxidables Austeníticos (medio mecanizado) y Duplex Аустенитная и дуплексная нержавеющая сталь 	
M3	<ul style="list-style-type: none"> Super austenitic stainless steel and super Duplex Acciai inossidabili super austenitici e super Duplex Super Austenitische Edelstähle und super Duplex Edelstähle 	<ul style="list-style-type: none"> Super aciers inoxydables austénitiques and super Duplex Aceros inoxidables Super Austeníticos y Super Duplex Супер аустенитные и супер дуплексные нержавеющие стали 	
K1	<ul style="list-style-type: none"> Grey cast iron Ghise grigie Grauguss 	<ul style="list-style-type: none"> Fonte grise Fundición gris Серый чугун 	150 ÷ 250 HB
K2	<ul style="list-style-type: none"> Nodular cast iron Ghise sferoidali Sphäroguss 	<ul style="list-style-type: none"> Fonte nodulaire Fundición nodular Чугун с шаровидным графитом 	150 ÷ 350 HB
K3	<ul style="list-style-type: none"> Austenitic cast iron Ghise austenitiche Austenitischer Guss 	<ul style="list-style-type: none"> Fonte austénitique Fundición austenítica Аустенитный чугун 	120 ÷ 260 HB
K4	<ul style="list-style-type: none"> ADI cast iron Ghise ADI ADI Guss 	<ul style="list-style-type: none"> Fonte ADI Fundición ADI Отпущенный ковкий чугун 	250 ÷ 500 HB

Technical info

ISO 513 complete list at page 738
 Lista completa ISO 513 a pagina 738
 ISO 513 komplette Liste auf Seite 738
 Liste complète ISO 513 à la page 738
 Lista completa ISO 513 a pag. 738
 ISO 513 полный список на стр. 738

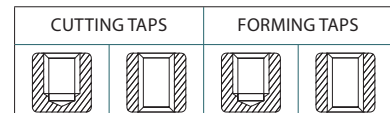

W.-NR	DIN	AISI-ASTM	TRADE MARK	SYSTEM CHART				
1.0116 1.0401 1.0715	St 37-3 C 15 9 SMn 28	A573 Grade 58 1015 1213	AVP	26 - 27	28 - 29	42	42	P1
1.0503 1.1221 1.7131 1.7147	C 45 Ck 60 16 MnCr 5 20 MnCr 5	1045 1064 5115 5120	-	26 - 27	28 - 29	42	42	P2
1.2330 1.7035 1.7218 1.7225	35 CrMo 4 41 Cr 4 25 CrMo 4 42 CrMo 4	4135 5140 4130 4142, 4140	-	26 - 27	28 - 29	42	42	P3
1.1231 1.1545 1.2510 1.3505	Ck 67 C 105 W1 100 MnCrW 4 100 Cr 6	1070 W1 O1 52100	-	26 - 27	28 - 29	42	42	P4
1.2311 1.2343 1.2344 1.2713	40 CrMnMo 7 X 38 CrMoV 5 1 X 40 CrMoV 5 1 55 NiCrMoV 6	H11 H13 L6	ORVAR - W302	26 - 27	28 - 29	42	42	P5
1.6546	40 NiCrMo 2 2	8640	HARDOX 400® TOOLOX 44®	26 - 27	28 - 29	42	42	P6
1.4000 1.4016 1.4021	X 6 Cr 13 X 6 Cr 17 X 20 Cr 13	403 430 420	-	26 - 27	28 - 29	42	42	P7
1.4540 1.4548	X 4 CrNiCuNb 16 4 X 5 CrNiCuNb 17 4	XM-12 630	15-5-PH 17-4-PH	26 - 27	28 - 29	42	42	P8
1.4301 1.4305 1.4306	X 5 CrNi 18 10 X 10 CrNiS 18 9 X 2 CrNi 19 11	304 303 304 L	-	30 - 31	30 - 31	43	43	M1
1.4401 1.4435 1.4571	X 5 CrNiMo 17 12 2 X 2 CrNiMo 18 14 3 X10 CrNiMoTi 18 10	316 316 L 316 Ti	-	30 - 31	30 - 31	43	43	M2
1.4410 1.4539 1.4943	X 2 CrNiMoN 25 7 4 X 2 NiCrMoCu 25 20 5 X 4 NiCrTi 25 15	F 53 904L 660	A286	30 - 31	30 - 31	43	43	M3
0.6020 0.6025 0.6035	GG-20 GG-25 GG-35	A48 30 B A48 35 B A48 50 B	-	32 - 33	34 - 35	-	-	K1
0.7040 0.7050 0.7070	GGG 40 GGG 50 GGG 70	A536, 80-55-06 A536, 100-70-03	-	32 - 33	34 - 35	-	-	K2
0.6660 0.7660	GGL-NiCr 20 2 GGG-NiCr 20 2	A436 Type 2 A436 Type D-2	Ni-Resist 2 Ni-Resist D-2	32 - 33	34 - 35	-	-	K3
-	GJS-800-8 GJS-1000-5	850/550/10 1050/700/7	ADI 800 ADI 1000	32 - 33	34 - 35	-	-	K4

SP

SL

PO

ST

ROLL

CARBIDE

LONG

HAND TAPS

EG (STI)

SPECIAL THREADS, GAUGES

THREAD MILLS

DIES

CENTER DRILLS

Technical info

System Chart Index by ISO 513 Classification

Intro

SP

SL

PO

ST

ROLL

CARBIDE

LONG

HAND
TAPS

EG (STI)

SPECIAL
THREADS,
GAUGES

THREAD
MILLS

DIES

CENTER
DRILLS

Technical
info

	MATERIALS	HARDNESS/Rm
	<p> Aluminium alloys ≤ 12% Si</p> <p> Leghe di alluminio ≤ 12% Si</p> <p> Aluminiumlegierungen ≤ 12% Si</p>	<p> Alliages d'aluminium ≤ 12 % Si</p> <p> Aleación de aluminio ≤ 12% Si</p> <p> Алюминиевое литье ≤ 12% Si</p>
	<p> Aluminium alloy > 12% Si and Aluminium-Magnesium</p> <p> Leghe di alluminio > 12% Si e alluminio-magnesio</p> <p> Aluminiumlegierungen > 12% Si und Aluminium-Magnesium</p>	<p> Alliages d'aluminium > 12 % Si et Aluminium-Magnesium</p> <p> Aleación de aluminio > 12% Si y Aluminio-Magnesio</p> <p> Алюминиевые сплавы с содержанием Si < 12% и алюмо-магниевые сплавы</p>
	<p> Copper alloy</p> <p> Leghe di rame</p> <p> Kupferlegierungen</p>	<p> Alliages de cuivre</p> <p> Aleación de cobre</p> <p> Медные сплавы</p>
	<p> Brass alloy and Bronze alloy</p> <p> Leghe di ottone e leghe di bronzo</p> <p> Bronze- und Messinglegierungen</p>	<p> Alliages de bronze et de laiton</p> <p> Aleación de Latón y Aleación de Bronce</p> <p> Латуни и бронзы</p>
	<p> Plastic material</p> <p> Polimeri</p> <p> Polymere</p>	<p> Polymères</p> <p> Material plástico</p> <p> Пластики</p>
	<p> Carbon fiber and composite</p> <p> Fibra di carbonio e compositi</p> <p> Faserwerkstoffe und Verbundwerkstoffe</p>	<p> Fibres et composites</p> <p> Fibra de carbonio y compositos</p> <p> Углеволокно и композиты</p>
	<p> Heat resistant super alloys (HRSA) Ni base (good machinability)</p> <p> Leghe a base di nichel resistenti al calore (buona lavorabilità)</p> <p> Warmfeste Superlegierungen (HRSA) Nickel-Legierungen (einfach zu bearbeiten)</p>	<p> Base Ni de superalliages résistants à la chaleur (HRSA) (bonne usinabilité)</p> <p> Super aleaciones resistentes al calor (HRSA) base Nickel (fácil mecanizado)</p> <p> Жаропрочные сплавы (HRSA) Ni (легкообрабатываемые)</p>
	<p> Heat resistant super alloys (HRSA) Ni base (medium machinability)</p> <p> Leghe a base di nichel resistenti al calore (media lavorabilità)</p> <p> Warmfeste Superlegierungen (HRSA) Nickel-Legierungen (mittlere Bearbeitbarkeit)</p>	<p> Superalliages résistants à la chaleur (HRSA) Ni base (usinabilité moyenne)</p> <p> Super aleaciones resistentes al calor (HRSA) base Nickel (medio mecanizado)</p> <p> Жаропрочные сплавы (HRSA) Ni (среднеобрабатываемые)</p>
	<p> Heat resistant super alloys (HRSA) Ni base (low machinability)</p> <p> Leghe a base di nichel resistenti al calore (difficile lavorabilità)</p> <p> Warmfeste Superlegierungen (HRSA) Nickel-Legierungen (schwierig zu bearbeiten)</p>	<p> Superalliages résistants à la chaleur (HRSA) Ni base (faible usinabilité)</p> <p> Super aleaciones resistentes al calor (HRSA) base Nickel (difícil mecanizado)</p> <p> Жаропрочные сплавы (HRSA) Ni (труднообрабатываемые)</p>
	<p> Low Titanium base alloy (good machinability)</p> <p> Leghe di titanio basso legate (buona lavorabilità)</p> <p> Titanlegierung (gut Bearbeitbarkeit)</p>	<p> Alliages de base à faible teneur en titane (bonne usinabilité)</p> <p> Aleaciones a bajo contenido Titanio (fácil mecanizado)</p> <p> Сплавы с низким содержанием Ti (легкообрабатываемые)</p>
	<p> High Titanium base alloy (medium machinability)</p> <p> Leghe di titanio alto legate (media lavorabilità)</p> <p> Hochfeste Titanlegierung (mittlere Bearbeitbarkeit)</p>	<p> Alliages à base de titane élevé (usinabilité moyenne)</p> <p> Aleaciones a alto contenido Titanio (medio mecanizado)</p> <p> Сплавы с высоким содержанием Ti (среднеобрабатываемые)</p>
	<p> Hardened steel</p> <p> Acciai temprati generali</p> <p> Gehärtete Stähle</p>	<p> Aciers trempés</p> <p> Aceros templados</p> <p> Закаленные стали</p>
	<p> Hardened steel</p> <p> Acciai temprati generali</p> <p> Gehärtete Stähle</p>	<p> Aciers trempés</p> <p> Aceros templados</p> <p> Закаленные стали</p>

ISO 513 complete list at page 738 Lista completa ISO 513 a pagina 738 ISO 513 komplette Liste auf Seite 738
 Liste complète ISO 513 à la page 738 Lista completa ISO 513 a pag. 738 ISO 513 полный список на стр. 738

Intro

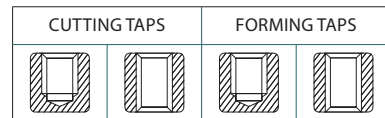

W.-NR	DIN	AISI-ASTM	TRADE MARK	SYSTEM CHART				
				CUTTING TAPS	FORMING TAPS			
3.0505 3.3206 3.4365	AlMn0,5Mg0,5 AlMgSi0,5 AlZn5,5MgCu	3105 7075	Anticorodal 063 Ergal	36 - 37	38 - 39	44	44	N1
3.2382 3.5103	G-AlSi12 G-MgSe3Zn2Zr1	A413.2 AMS 4442	-	36 - 37	38 - 39	44	44	N2
2.0060 2.0321 2.0530	E-Cu57 CuZn37 CuZn38Sn1	-	-	36 - 37	38 - 39	44	44	N3
2.0220 2.0401 2.1020	CuZn5 CuZn39Pb3 CuSn6	-	OT-58	36 - 37	38 - 39	44	44	N4
		-		36 - 37	38 - 39	44	44	N5
		-		36 - 37	38 - 39	44	44	N6
2.4856	NiCr17Mo17Few NiCr19Fe19NbMo	-	Hastelloy C (casting) Inconel 625 (casting)	40	40	-	-	S1
2.4856 2.4668	NiCr22Mo9Nb NiCr19Fe19NbMo	-	Inconel 625 (forged) Inconel 718 (casting)	40	40	-	-	S2
2.4654 2.4668	NiCr20Co14MoTi NiCr19Fe19NbMo	-	Waspalloy (forged) Inconel 718 (forged)	40	40	-	-	S3
3.7055	TiAl2Sn4Zr2MoSi Ti 99,6	265-G1 265-G3	Grade 1 Grade 3	40	40	-	-	S4
3.7164	TiAl6V4	-	Grade 5	40	40	-	-	S5
1.7131	16 MnCr 5	5115	-	41	41	-	-	H1
1.3505	100 Cr 6	52100	-	41	41	-	-	H2

SP

SL

PO

ST

ROLL

CARBIDE

LONG

HAND TAPS

EG (STI)

SPECIAL THREADS, GAUGES

THREAD MILLS

DIES

CENTER DRILLS

Technical info

System Chart - ISO P

🇮🇹 Grafici applicativi 🇩🇪 Anwendungstabellen 🇫🇷 Graphiques d'application 🇪🇸 Gráficos de aplicación 🇷🇺 Диаграммы области применения

Intro

CUTTING TAPS

SP

SL

PO

ST

ROLL

CARBIDE

LONG

HAND TAPS

EG (STI)

SPECIAL THREADS, GAUGES

THREAD MILLS

DIES

CENTER DRILLS

Technical info

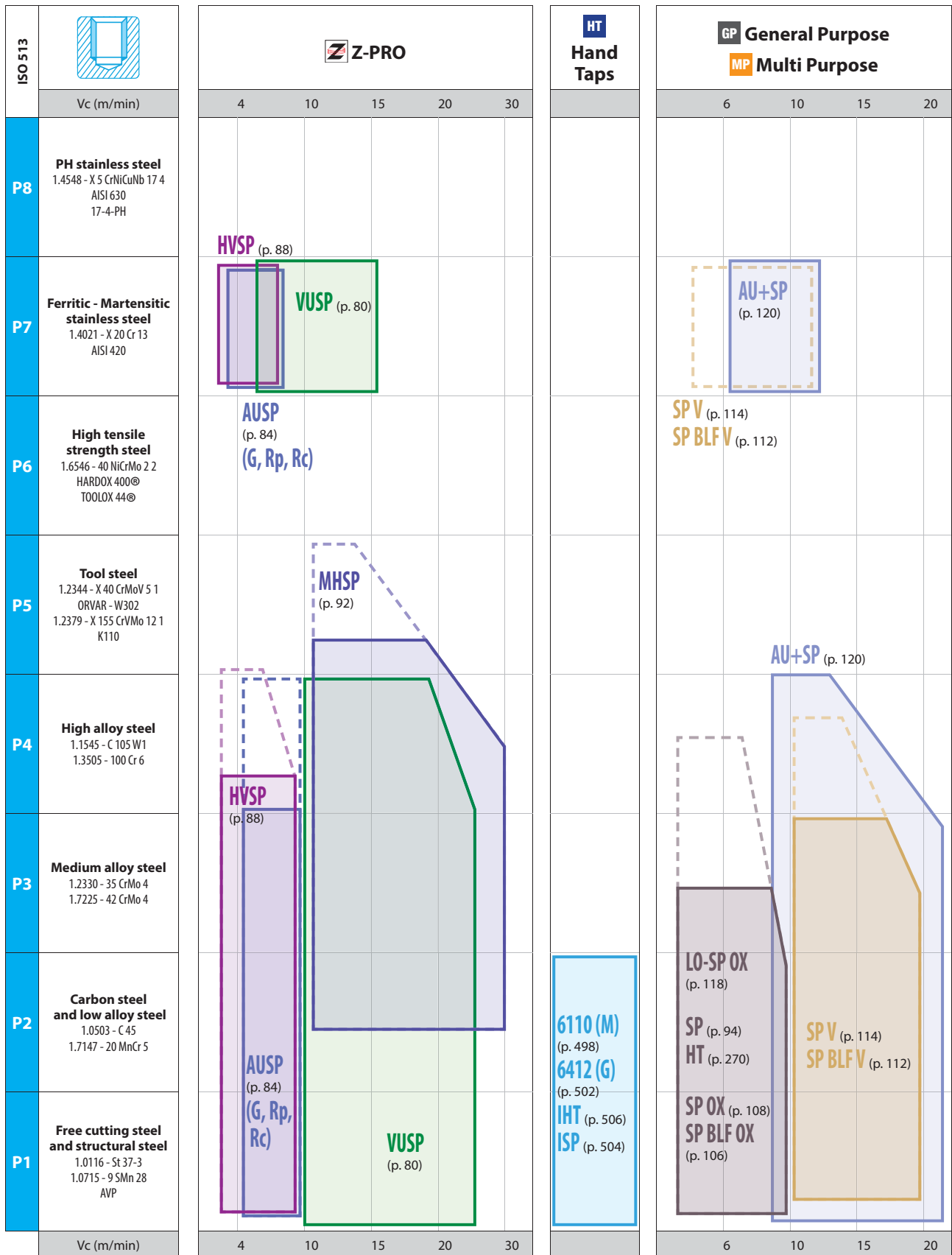

— Most suitable
- - - Suitable

CUTTING TAPS

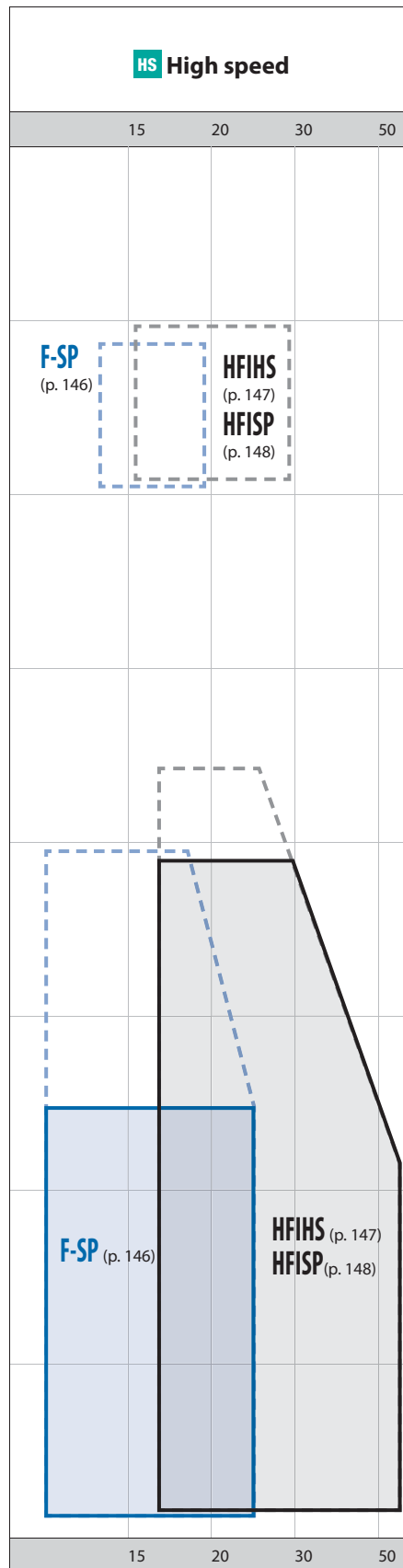
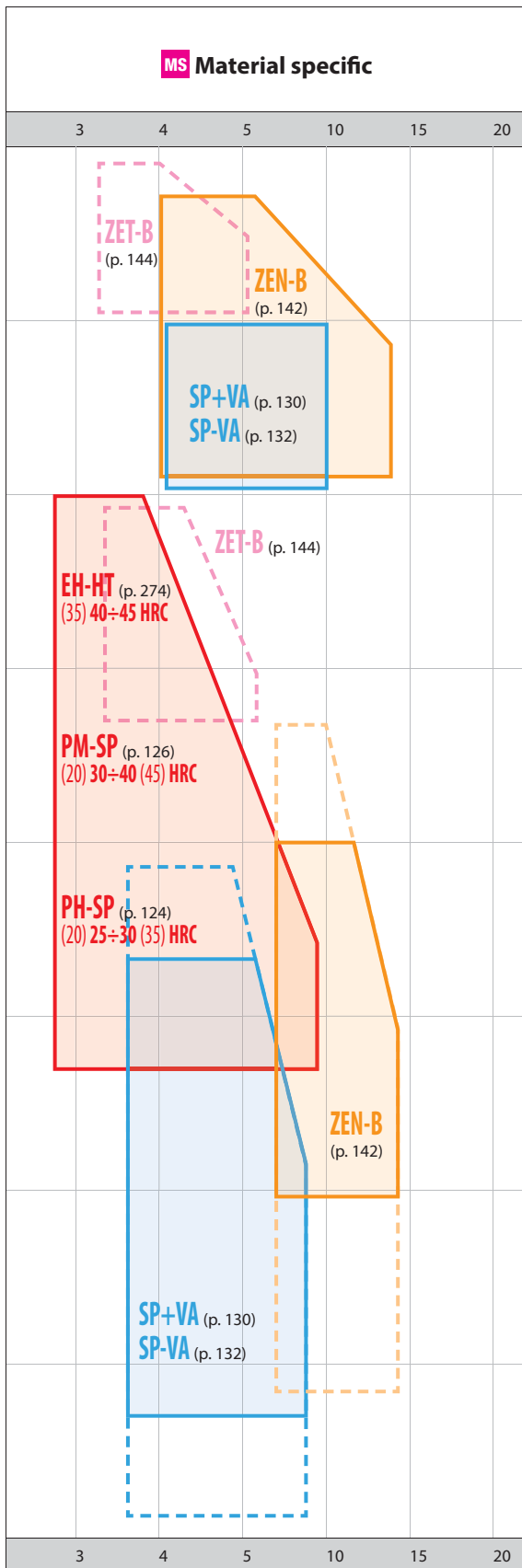

	ISO 513
Vc (m/min)	
PH stainless steel 1.4548 - X 5 CrNiCuNb 17 4 AISI 630 17-4-PH	P8
Ferritic - Martensitic stainless steel 1.4021 - X 20 Cr 13 AISI 420	P7
High tensile strength steel 1.6546 - 40 NiCrMo 2 2 HARDOX 400® TOOLOX 44®	P6
Tool steel 1.2344 - X 40 CrMoV 5 1 ORVAR - W302 1.2379 - X 155 CrVMo 12 1 K110	P5
High alloy steel 1.1545 - C 105 W1 1.3505 - 100 Cr 6	P4
Medium alloy steel 1.2330 - 35 CrMo 4 1.7225 - 42 CrMo 4	P3
Carbon steel and low alloy steel 1.0503 - C 45 1.7147 - 20 MnCr 5	P2
Free cutting steel and structural steel 1.0116 - St 37-3 1.0715 - 9SMn 28 AVP	P1
Vc (m/min)	

— Most suitable
- - - Suitable

- SP
- SL
- PO
- ST
- ROLL
- CARBIDE
- LONG
- HAND TAPS
- EG (STI)
- SPECIAL THREADS, GAUGES
- THREAD MILLS
- DIES
- CENTER DRILLS

Technical info

System Chart - ISO P

■ Grafici applicativi
 ■ Anwendungstabellen
 ■ Graphiques d'application
 ■ Gráficos de aplicación
 ■ Диаграммы области применения

Intro

CUTTING TAPS

SP

SL

PO

ST

ROLL

CARBIDE

LONG

HAND TAPS

EG (STI)

SPECIAL THREADS, GAUGES

THREAD MILLS

DIES

CENTER DRILLS

Technical info

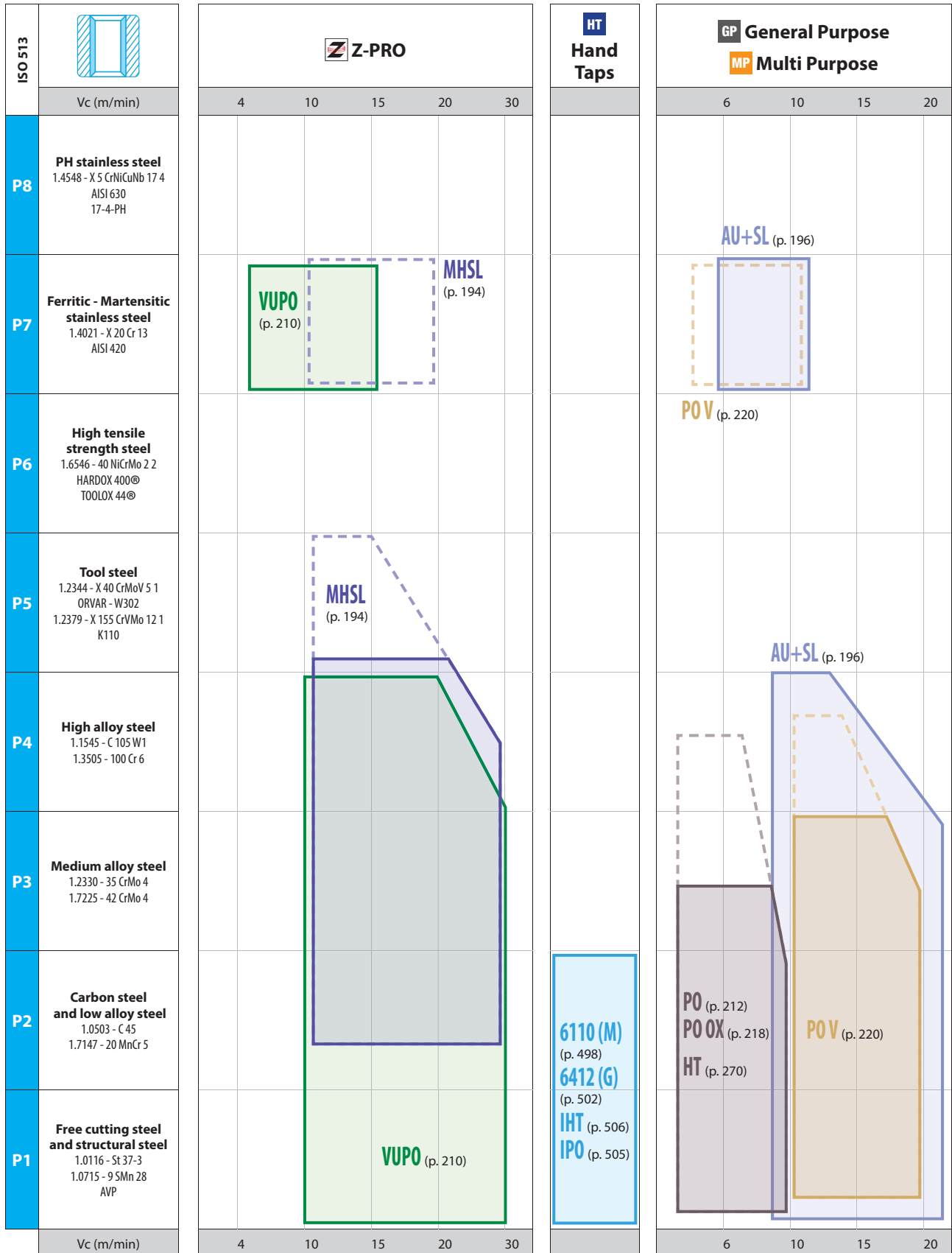

CUTTING TAPS

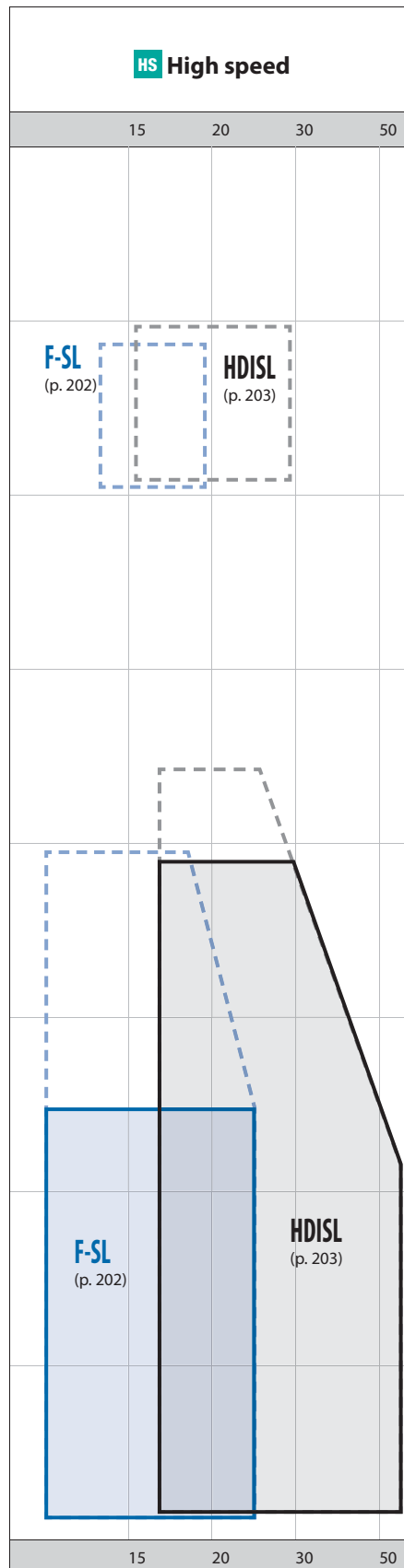
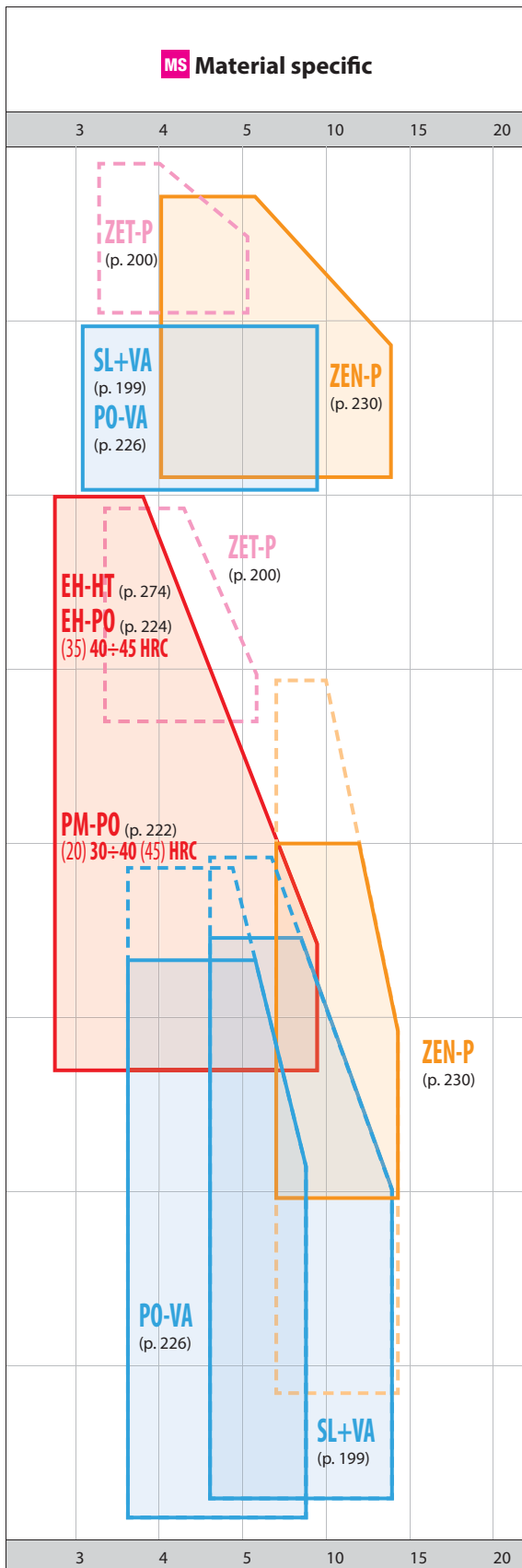

	ISO 513
Vc (m/min)	
PH stainless steel 1.4548 - X 5 CrNiCuNb 17 4 AISI 630 17-4-PH	P8
Ferritic - Martensitic stainless steel 1.4021 - X 20 Cr 13 AISI 420	P7
High tensile strength steel 1.6546 - 40 NiCrMo 2 2 HARDOX 400® TOOLOX 44®	P6
Tool steel 1.2344 - X 40 CrMoV 5 1 ORVAR - W302 1.2379 - X 155 CrV Mo 12 1 K110	P5
High alloy steel 1.1545 - C 105 W1 1.3505 - 100 Cr 6	P4
Medium alloy steel 1.2330 - 35 CrMo 4 1.7225 - 42 CrMo 4	P3
Carbon steel and low alloy steel 1.0503 - C 45 1.7147 - 20 MnCr 5	P2
Free cutting steel and structural steel 1.0116 - St 37-3 1.0715 - 9SMn 28 AVP	P1
Vc (m/min)	

— Most suitable
- - - Suitable

System Chart - ISO M

🇮🇹 Grafici applicativi 🇩🇪 Anwendungstabellen 🇫🇷 Graphiques d'application 🇪🇸 Gráficos de aplicación 🇷🇺 Диаграммы области применения

Intro

CUTTING TAPS

SP

SL

PO

ST

ROLL

CARBIDE

LONG

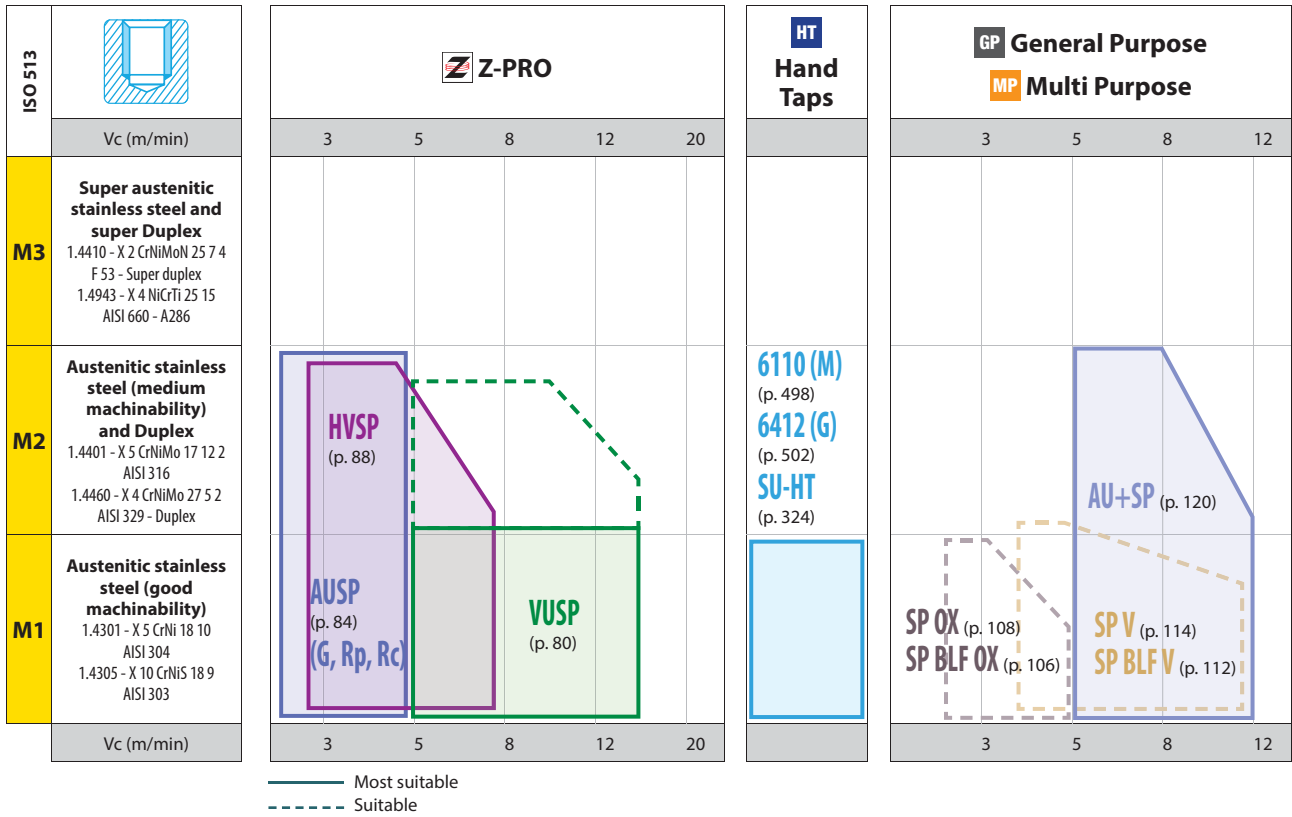

HAND
TAPS

EG (STI)

SPECIAL
THREADS,
GAUGES

THREAD
MILLS

DIES

CENTER
DRILLS

Technical
info

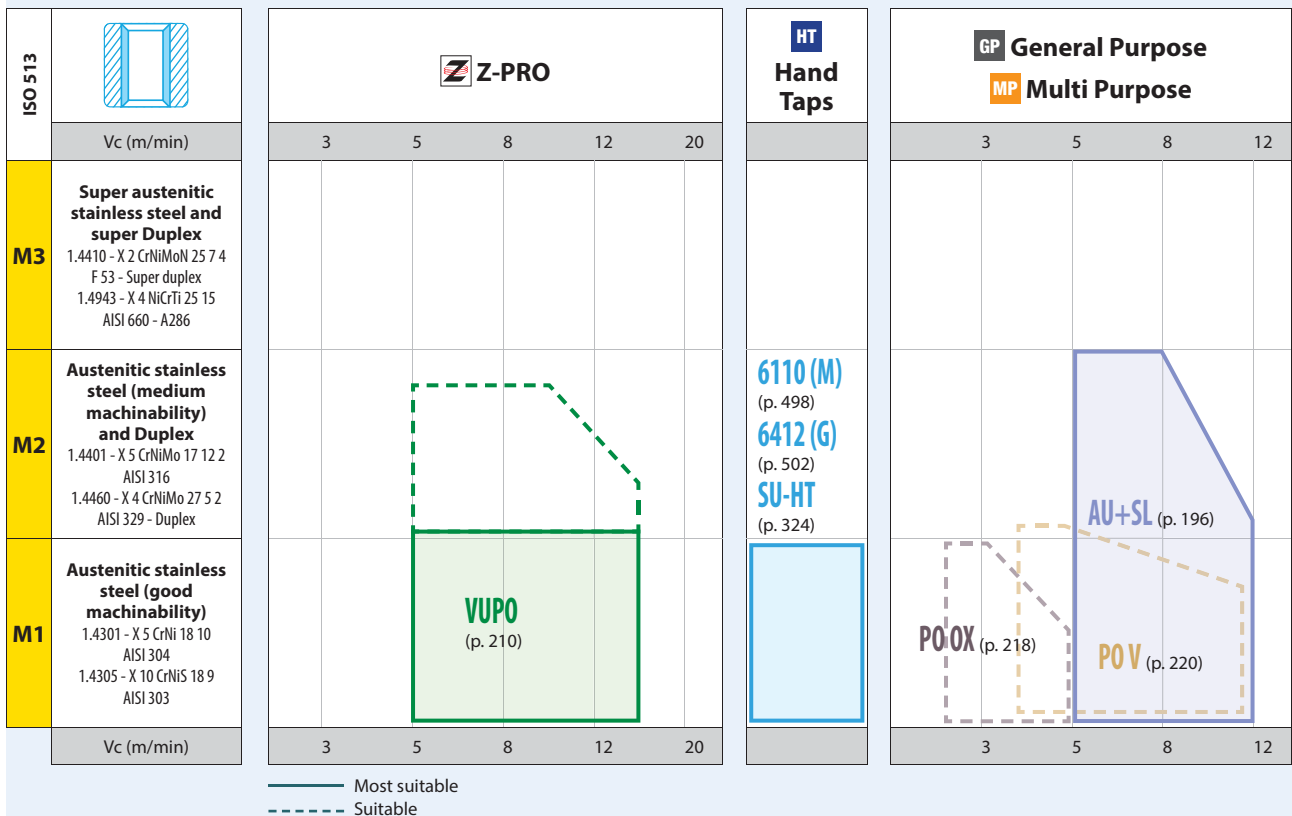

CUTTING TAPS

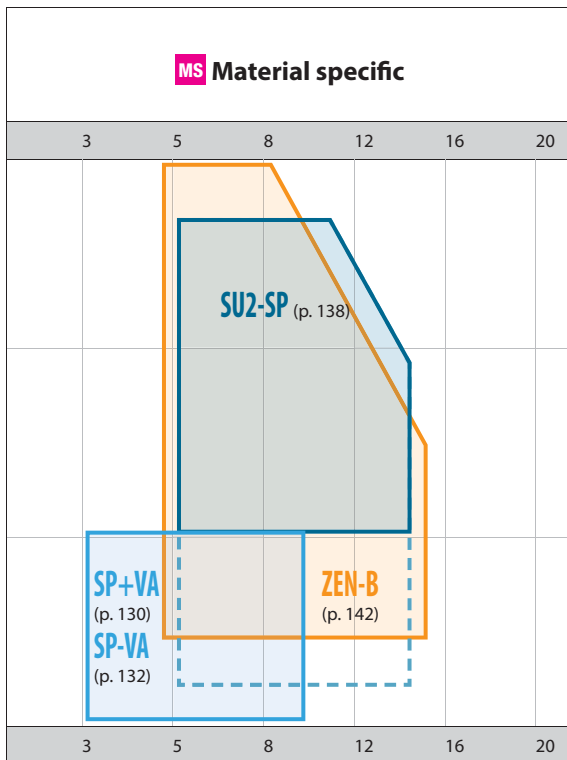

— Most suitable
- - - Suitable

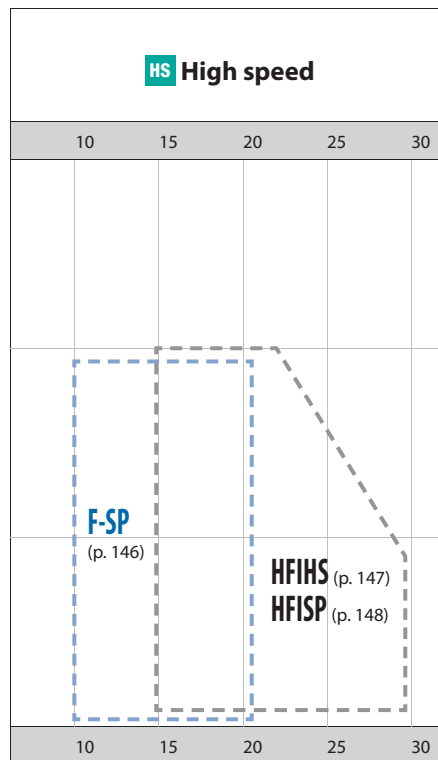

	ISO 513
Vc (m/min)	
Super austenitic stainless steel and super Duplex 1.4410 - X 2 CrNiMoN 25 7 4 F 53 - Super duplex 1.4943 - X 4 NiCrTi 25 15 AISI 660 - A286	M3
Austenitic stainless steel (medium machinability) and Duplex 1.4401 - X 5 CrNiMo 17 12 2 AISI 316 1.4460 - X 4 CrNiMo 27 5 2 AISI 329 - Duplex	M2
Austenitic stainless steel (good machinability) 1.4301 - X 5 CrNi 18 10 AISI 304 1.4305 - X 10 CrNiS 18 9 AISI 303	M1
Vc (m/min)	

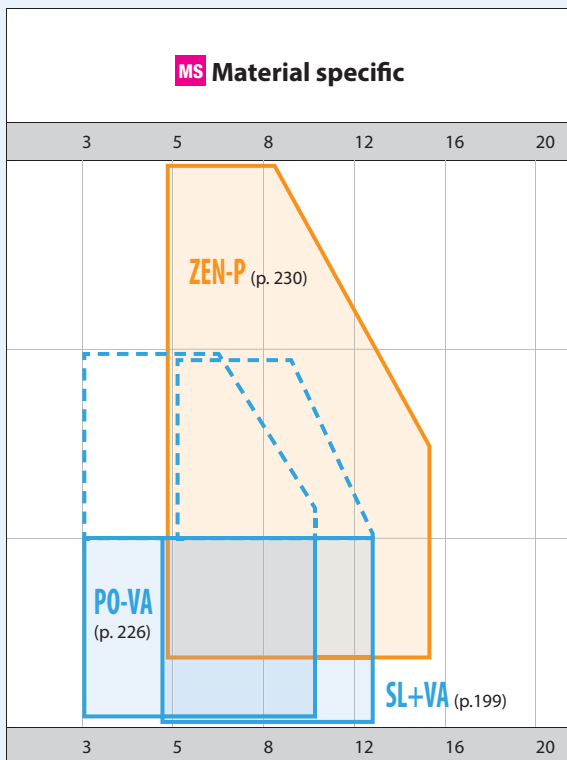

— Most suitable
- - - Suitable

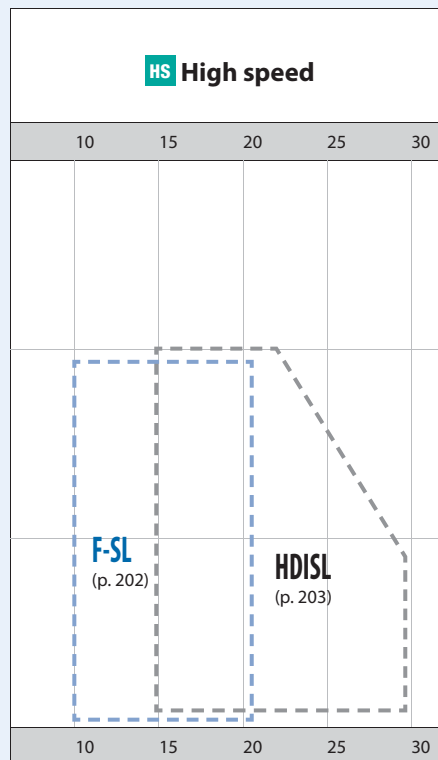

	ISO 513
Vc (m/min)	
Super austenitic stainless steel and super Duplex 1.4410 - X 2 CrNiMoN 25 7 4 F 53 - Super duplex 1.4943 - X 4 NiCrTi 25 15 AISI 660 - A286	M3
Austenitic stainless steel (medium machinability) and Duplex 1.4401 - X 5 CrNiMo 17 12 2 AISI 316 1.4460 - X 4 CrNiMo 27 5 2 AISI 329 - Duplex	M2
Austenitic stainless steel (good machinability) 1.4301 - X 5 CrNi 18 10 AISI 304 1.4305 - X 10 CrNiS 18 9 AISI 303	M1
Vc (m/min)	

System Chart - ISO K

Grafici applicativi
 Anwendungstabellen
 Graphiques d'application
 Gráficos de aplicación
 Диаграммы области применения

Intro

CUTTING TAPS

SP

SL

PO

ST

ROLL

CARBIDE

LONG

HAND TAPS

EG (STI)

SPECIAL THREADS, GAUGES

THREAD MILLS

DIES

CENTER DRILLS

Technical info

ISO 513	 Vc (m/min)	Z-PRO					HT Hand Taps	GP General Purpose MP Multi Purpose			
		3	5	8	12	20		5	8	12	16
K4	ADI cast iron GJS-1000-5 - ADI 1000										
K3	Austenitic cast iron 0.6660 - GGL-NiCr 20 2 Ni-Resist 2										
K2	Nodular cast iron 0.7040 - GGG 40	AUSP (p. 84) (G, Rp, Rc)		VUSP (p. 80)			AU+SP (p. 120)				
K1	Grey cast iron 0.6025 - GG-25						6110 (M) (p. 498) 6412 (G) (p. 502)	HT (p. 270) SP (p. 94)			
	Vc (m/min)	3	5	8	12	20		5	8	12	16

Most suitable
 Suitable

CUTTING TAPS

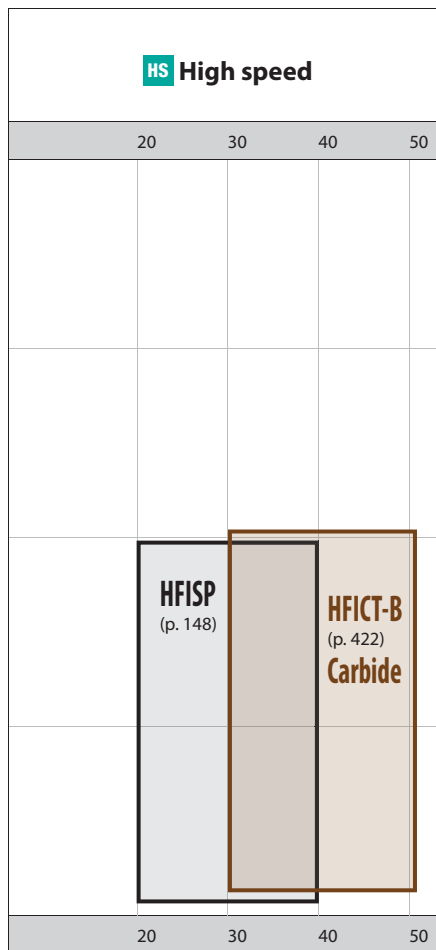
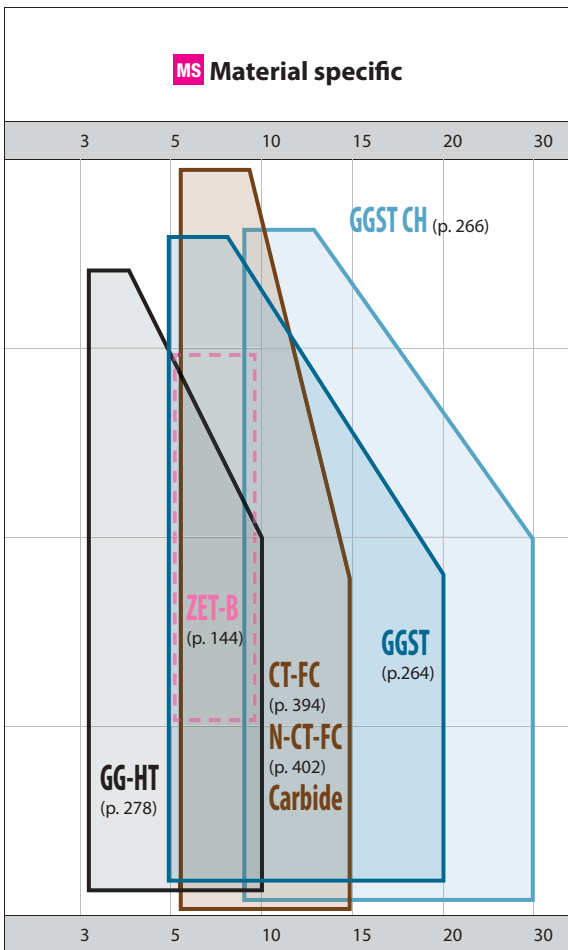

	ISO 513
Vc (m/min)	
ADI cast iron GJS-1000-5 - ADI 1000	K4
Austenitic cast iron 0.6660 - GGL-NiCr 20 2 Ni-Resist 2	K3
Nodular cast iron 0.7040 - GGG 40	K2
Grey cast iron 0.6025 - GG-25	K1
Vc (m/min)	

— Most suitable
- - - Suitable

- SP
- SL
- PO
- ST
- ROLL
- CARBIDE
- LONG
- HAND TAPS
- EG (STI)
- SPECIAL THREADS, GAUGES
- THREAD MILLS
- DIES
- CENTER DRILLS
- Technical info

System Chart - ISO K

Grafici applicativi
 Anwendungstabellen
 Graphiques d'application
 Gráficos de aplicación
 Диаграммы области применения

Intro

CUTTING TAPS

SP

SL

PO

ST

ROLL

CARBIDE

LONG

HAND TAPS

EG (STI)

SPECIAL THREADS, GAUGES

THREAD MILLS

DIES

CENTER DRILLS

Technical info

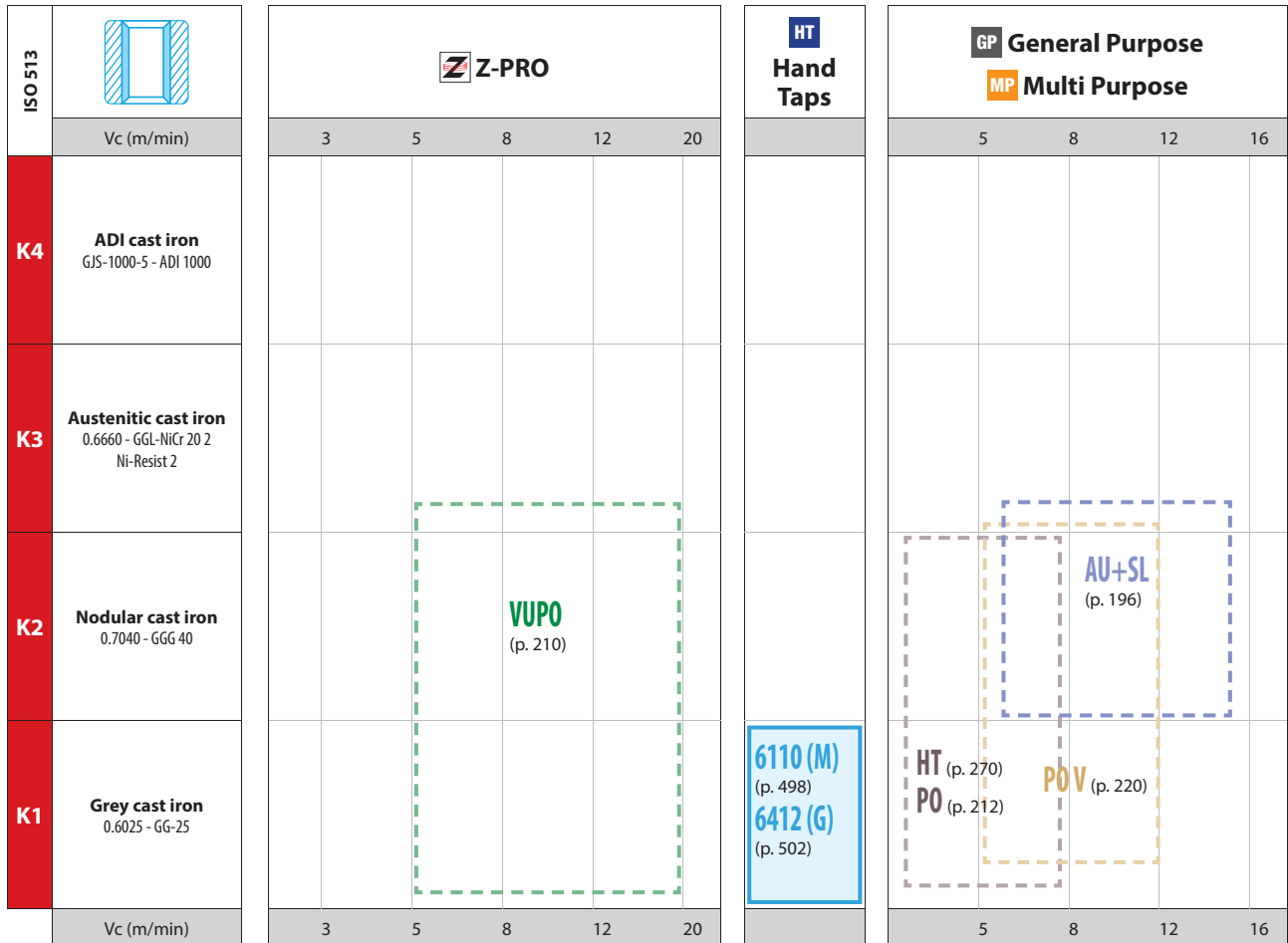

Most suitable
 Suitable

6110 (M)
 (p. 498)
6412 (G)
 (p. 502)

HT (p. 270)
PO (p. 212)
POV (p. 220)
AU+SL
 (p. 196)

CUTTING TAPS

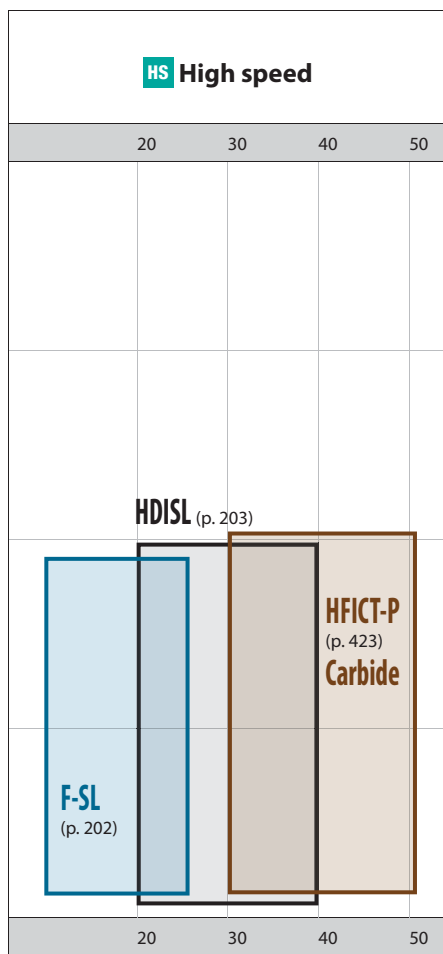
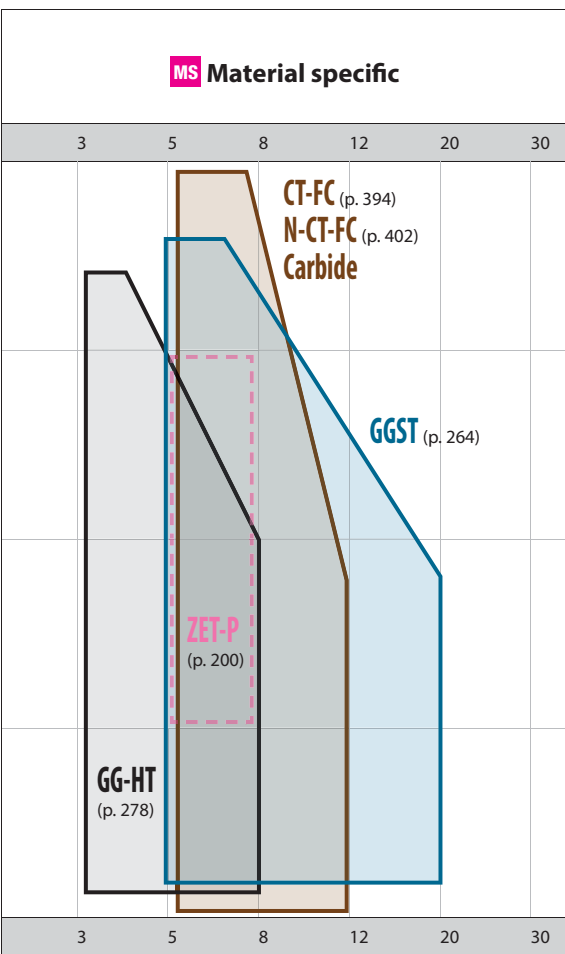

	ISO 513
Vc (m/min)	
ADI cast iron GJS-1000-5 - ADI 1000	K4
Austenitic cast iron 0.6660 - GGL-NiCr 20 2 Ni-Resist 2	K3
Nodular cast iron 0.7040 - GGG 40	K2
Grey cast iron 0.6025 - GG-25	K1
Vc (m/min)	

— Most suitable
- - - - - Suitable

- SP
- SL
- PO
- ST
- ROLL
- CARBIDE
- LONG
- HAND TAPS
- EG (STI)
- SPECIAL THREADS, GAUGES
- THREAD MILLS
- DIES
- CENTER DRILLS
- Technical info

System Chart - ISO N

🇮🇹 Grafici applicativi
 🇩🇪 Anwendungstabellen
 🇫🇷 Graphiques d'application
 🇪🇸 Gráficos de aplicación
 🇷🇺 Диаграммы области применения

Intro

CUTTING TAPS

SP

SL

PO

ST

ROLL

CARBIDE

LONG

HAND TAPS

EG (STI)

SPECIAL THREADS, GAUGES

THREAD MILLS

DIES

CENTER DRILLS

Technical info

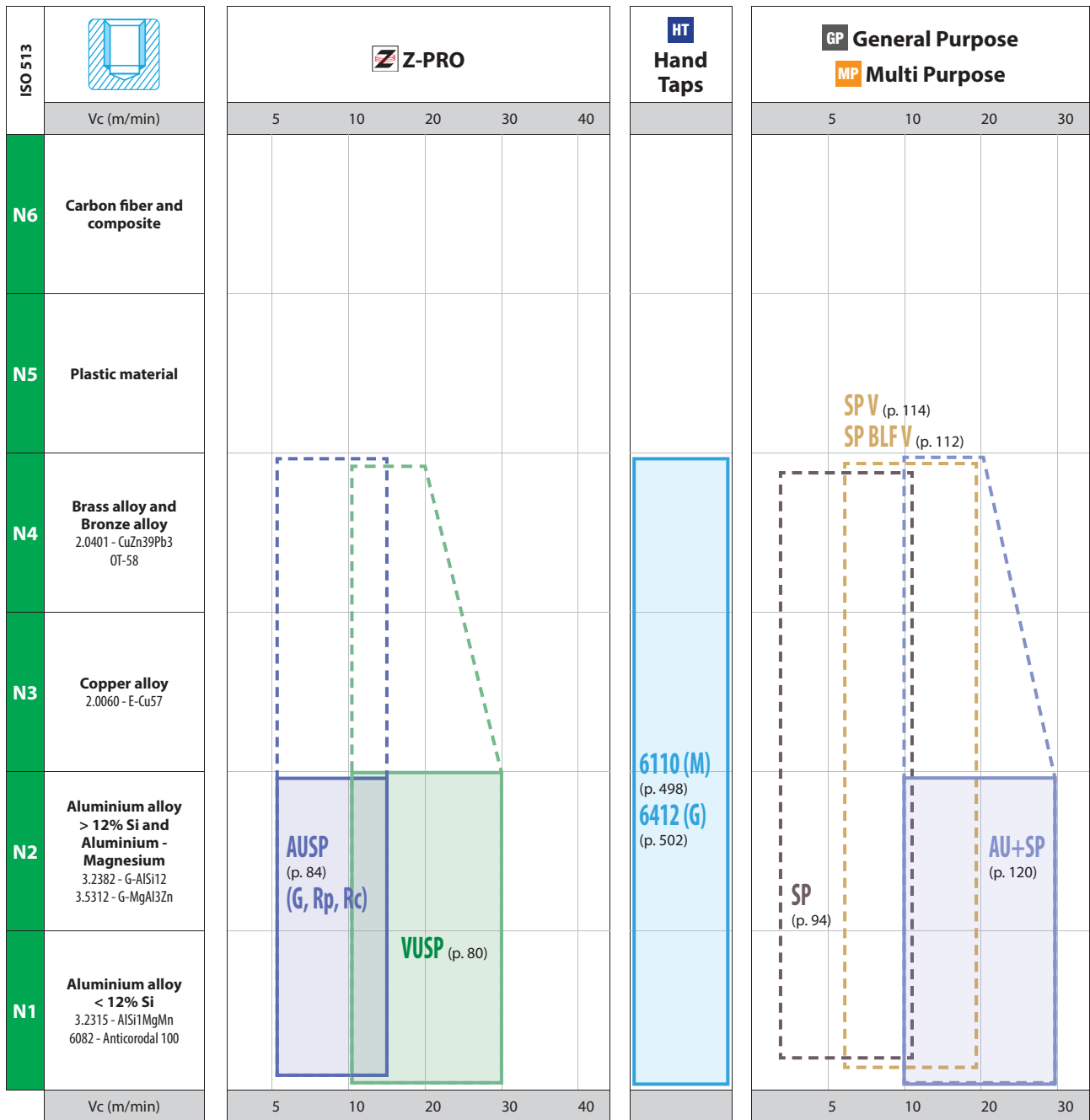

Most suitable
 Suitable

CUTTING TAPS

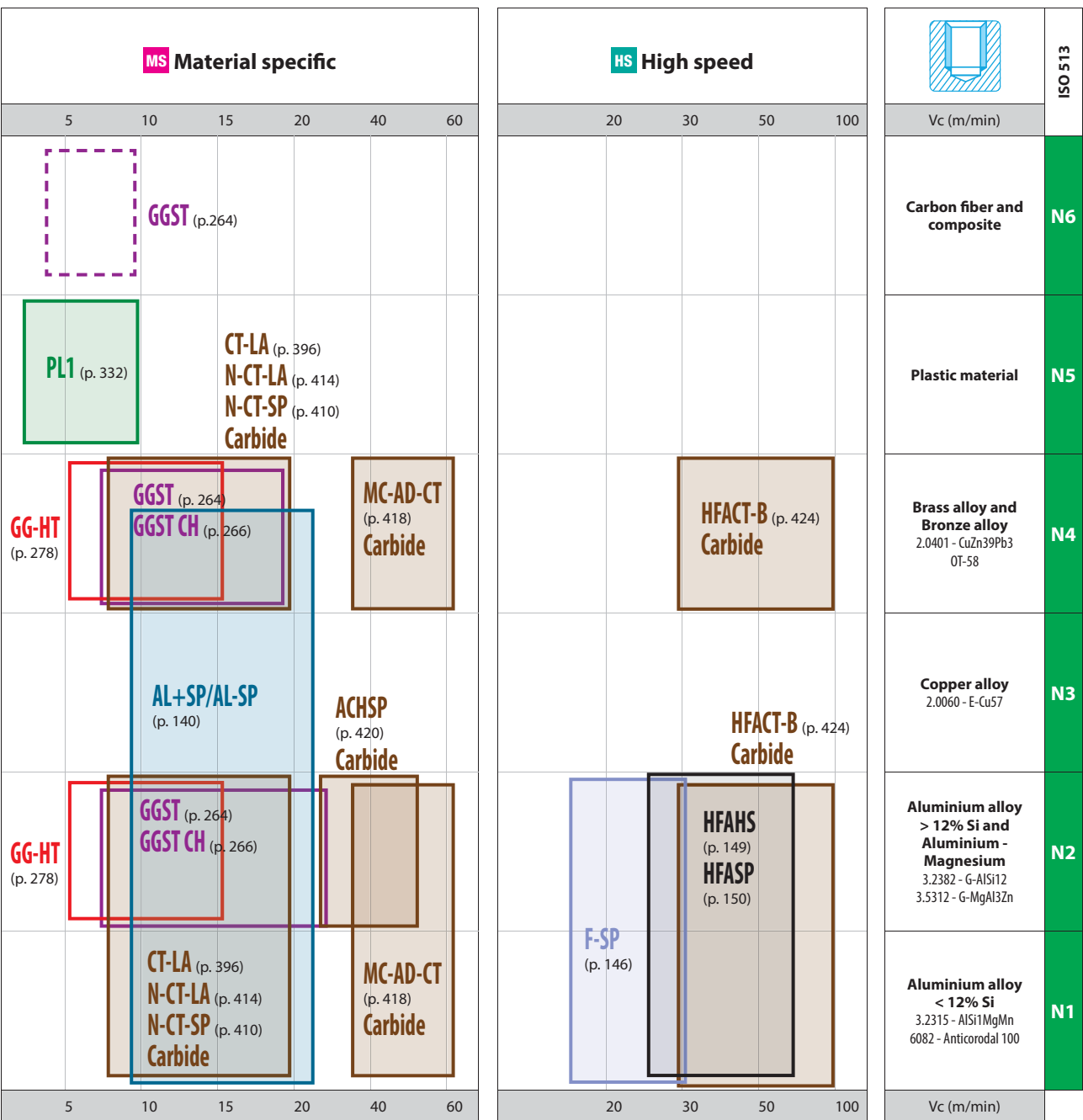

— Most suitable
 - - - - - Suitable

SP
 SL
 PO
 ST
 ROLL
 CARBIDE
 LONG
 HAND TAPS
 EG (STI)
 SPECIAL THREADS, GAUGES
 THREAD MILLS
 DIES
 CENTER DRILLS
 Technical info

System Chart - ISO N

🇮🇹 Grafici applicativi
🇩🇪 Anwendungstabellen
🇫🇷 Graphiques d'application
🇪🇸 Gráficos de aplicación
🇷🇺 Диаграммы области применения

Intro

CUTTING TAPS

SP

SL

PO

ST

ROLL

CARBIDE

LONG

HAND TAPS

EG (STI)

SPECIAL THREADS, GAUGES

THREAD MILLS

DIES

CENTER DRILLS

Technical info

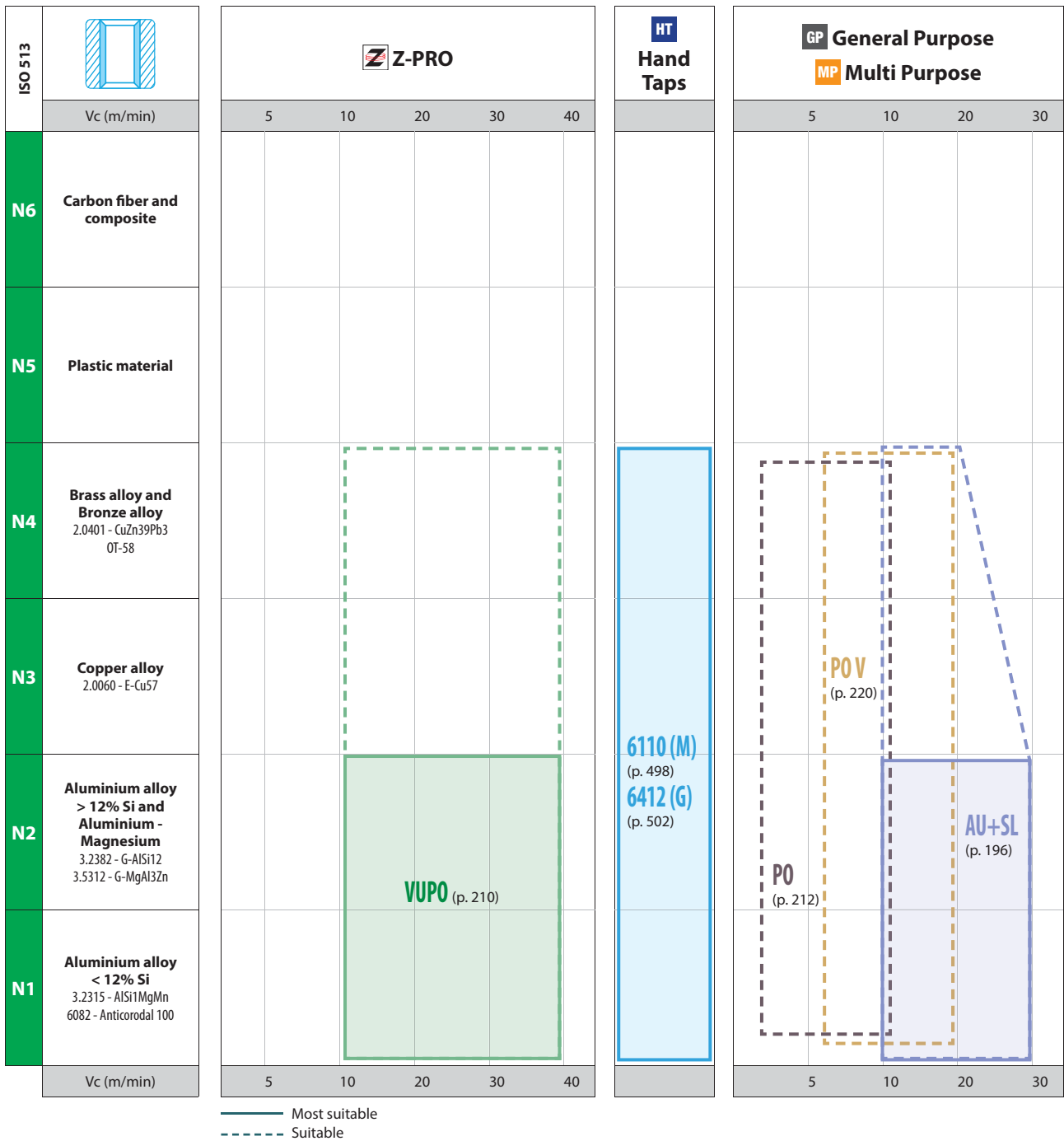

CUTTING TAPS

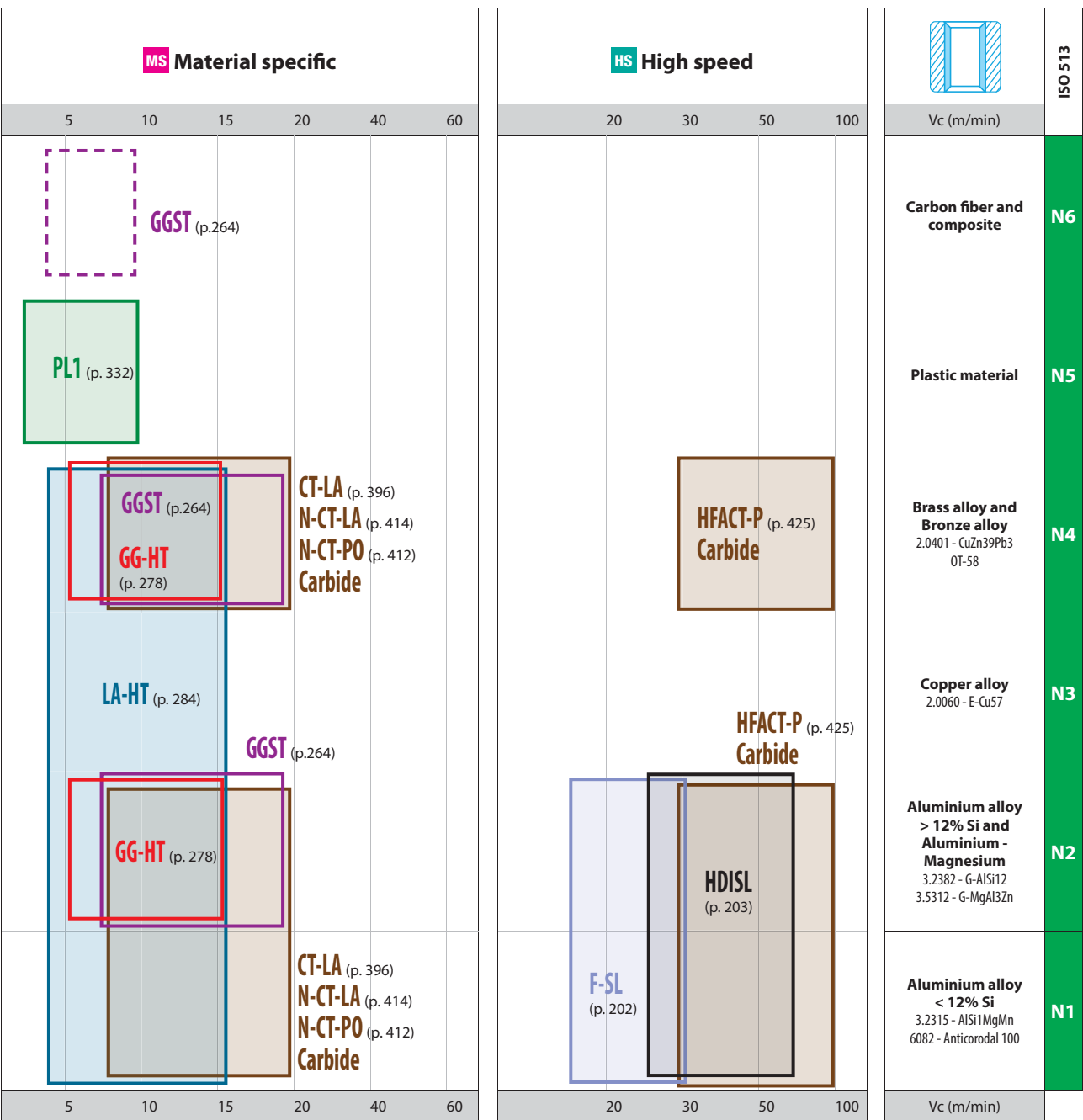

— Most suitable
- - - Suitable

SP
SL
PO
ST
ROLL
CARBIDE
LONG
HAND TAPS
EG (STI)
SPECIAL THREADS, GAUGES
THREAD MILLS

DIES
CENTER DRILLS

Technical info

System Chart - ISO S

Grafici applicativi
 Anwendungstabellen
 Graphiques d'application
 Gráficos de aplicación
 Диаграммы области применения

Intro

CUTTING TAPS

SP

SL

PO

ST

ROLL

CARBIDE

LONG

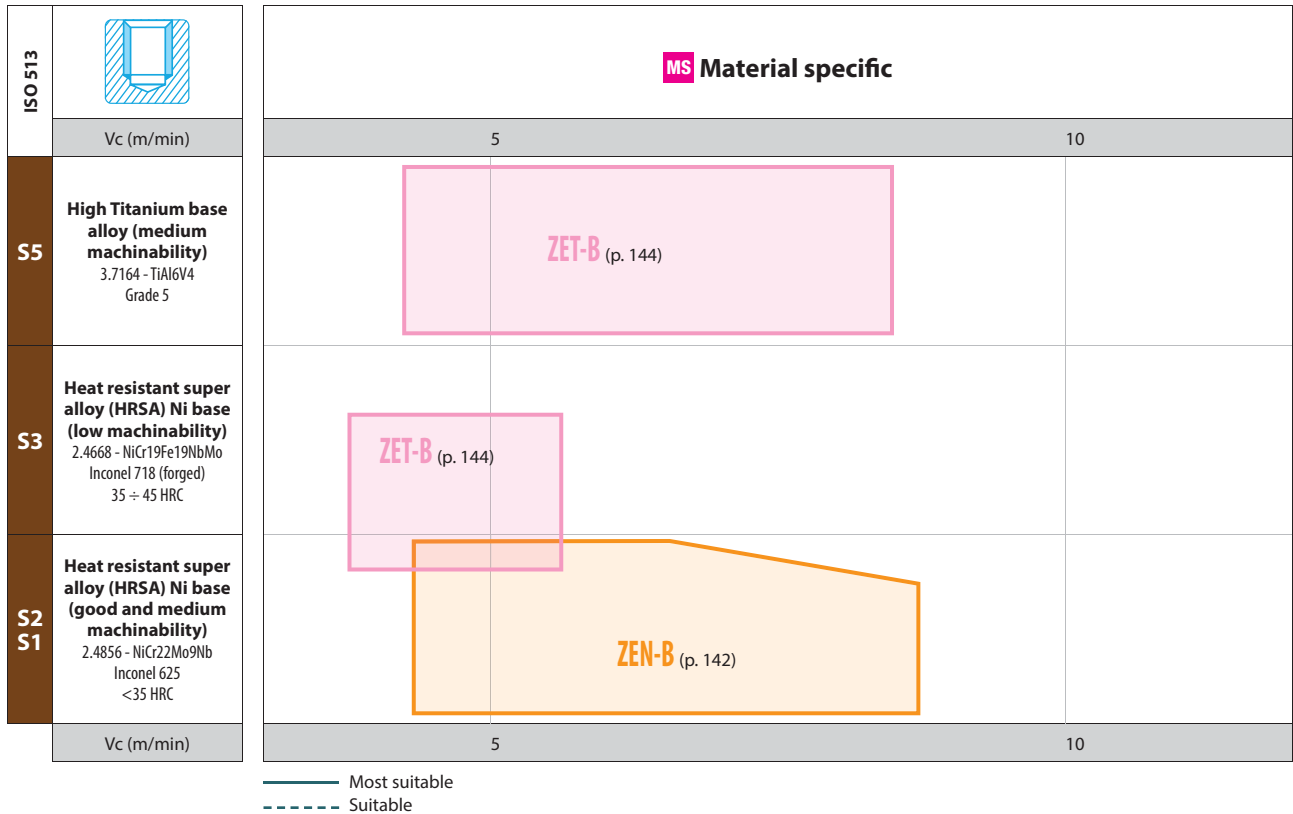

HAND TAPS

EG (STI)

SPECIAL THREADS, GAUGES

THREAD MILLS

DIES

CENTER DRILLS

Technical info

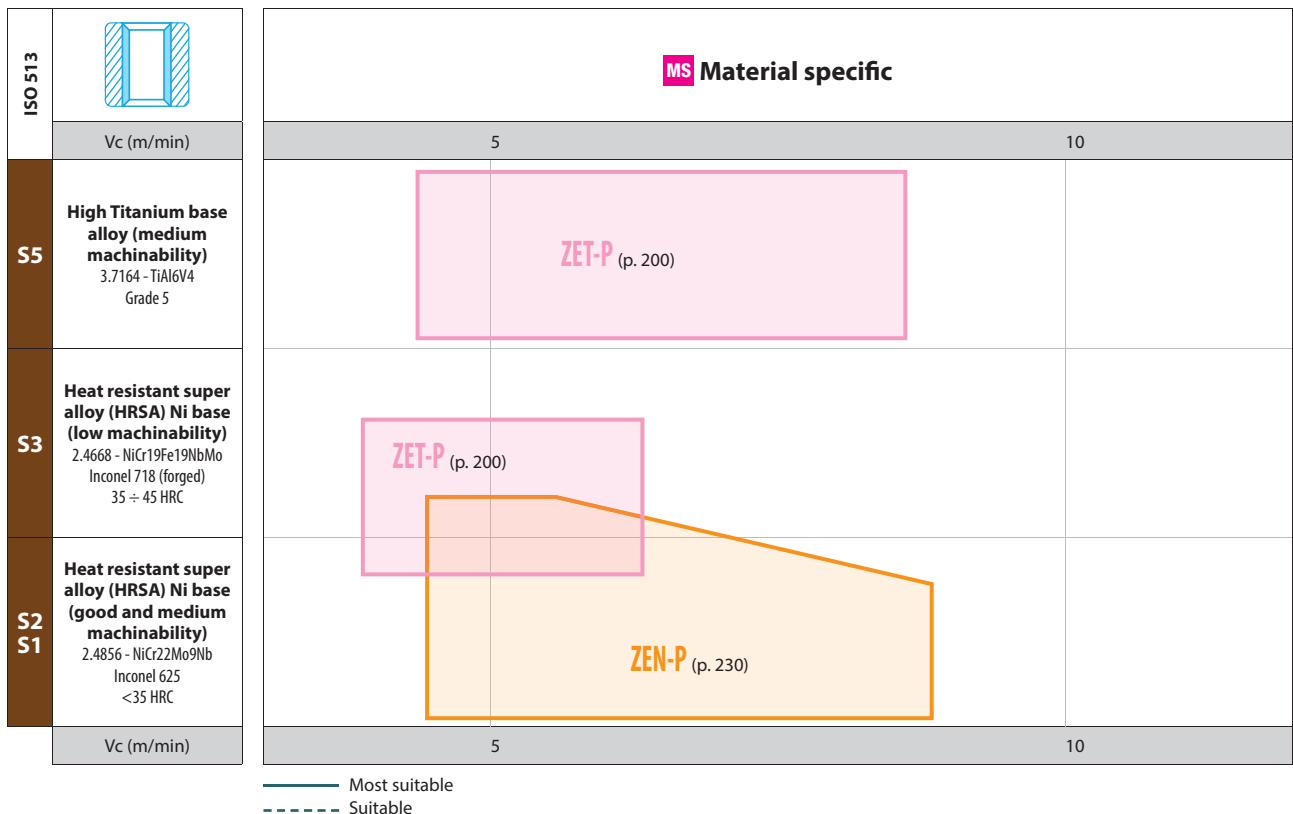

System Chart - ISO H

🇮🇹 Grafici applicativi
 🇩🇪 Anwendungstabellen
 🇫🇷 Graphiques d'application
 🇪🇸 Gráficos de aplicación
 🇷🇺 Диаграммы области применения

Intro

CUTTING TAPS

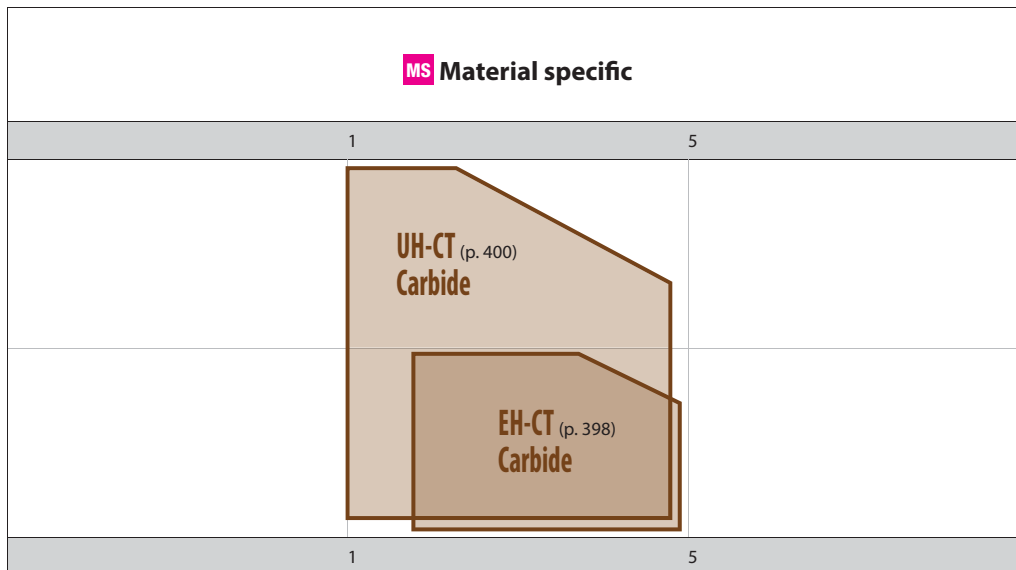

— Most suitable
 - - - Suitable

	ISO 513
Vc (m/min)	
Hardened steel <63HRC	H2
Hardened steel <55HRC	H1
Vc (m/min)	

SP

SL

PO

ST

ROLL

CARBIDE

LONG

HAND TAPS

EG (STI)

SPECIAL THREADS, GAUGES

THREAD MILLS

DIES

CENTER DRILLS

Technical info

System Chart - ISO P

Grafici applicativi
 Anwendungstabellen
 Graphiques d'application
 Gráficos de aplicación
 Диаграммы области применения

Intro

FORMING TAPS

SP

SL

PO

ST

ROLL

CARBIDE

LONG

HAND TAPS

EG (STI)

SPECIAL THREADS, GAUGES

THREAD MILLS

DIES

CENTER DRILLS

Technical info

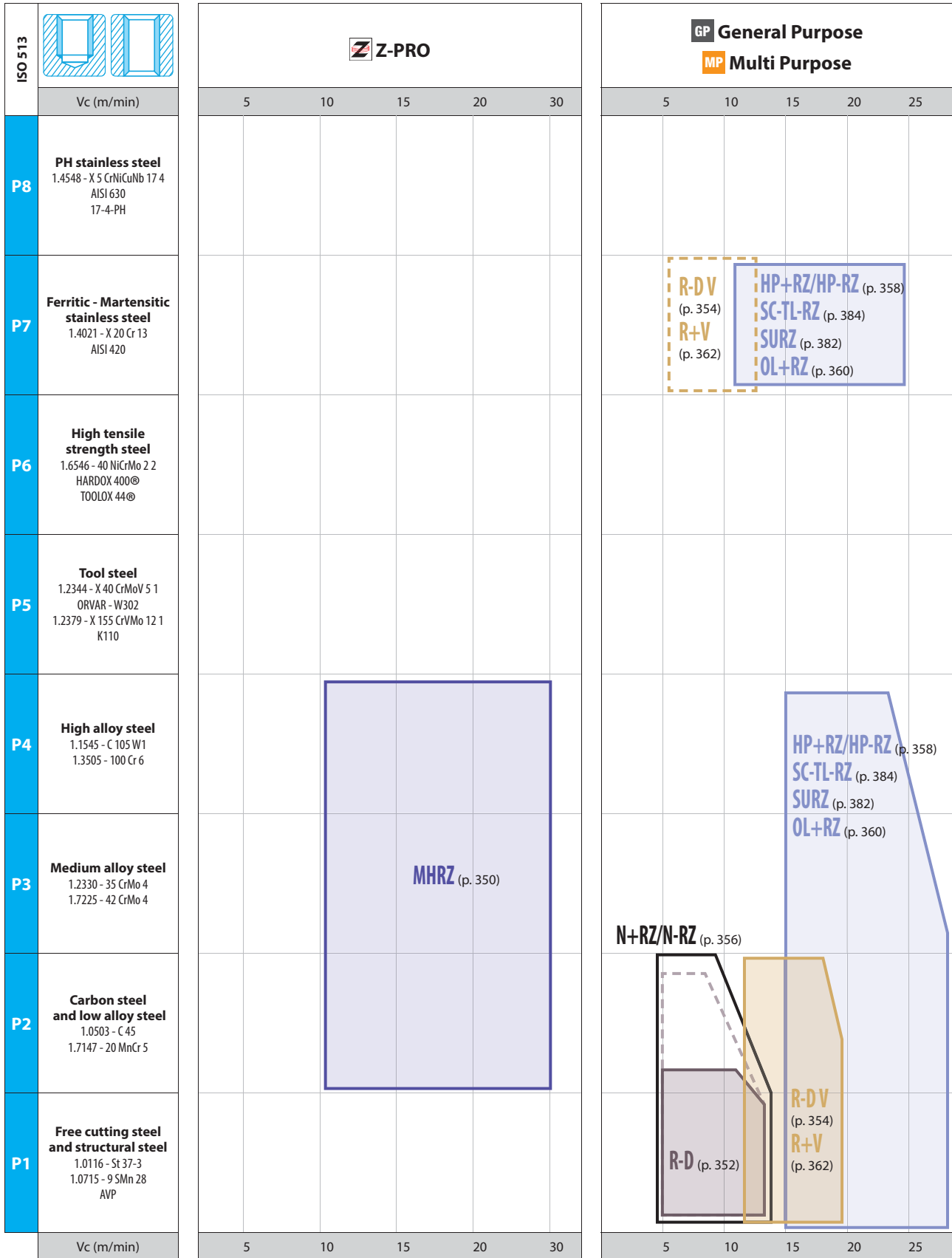

Most suitable
 Suitable

System Chart - ISO M

🇮🇹 Grafici applicativi
 🇩🇪 Anwendungstabellen
 🇫🇷 Graphiques d'application
 🇪🇸 Gráficos de aplicación
 🇷🇺 Диаграммы области применения

Intro

FORMING TAPS

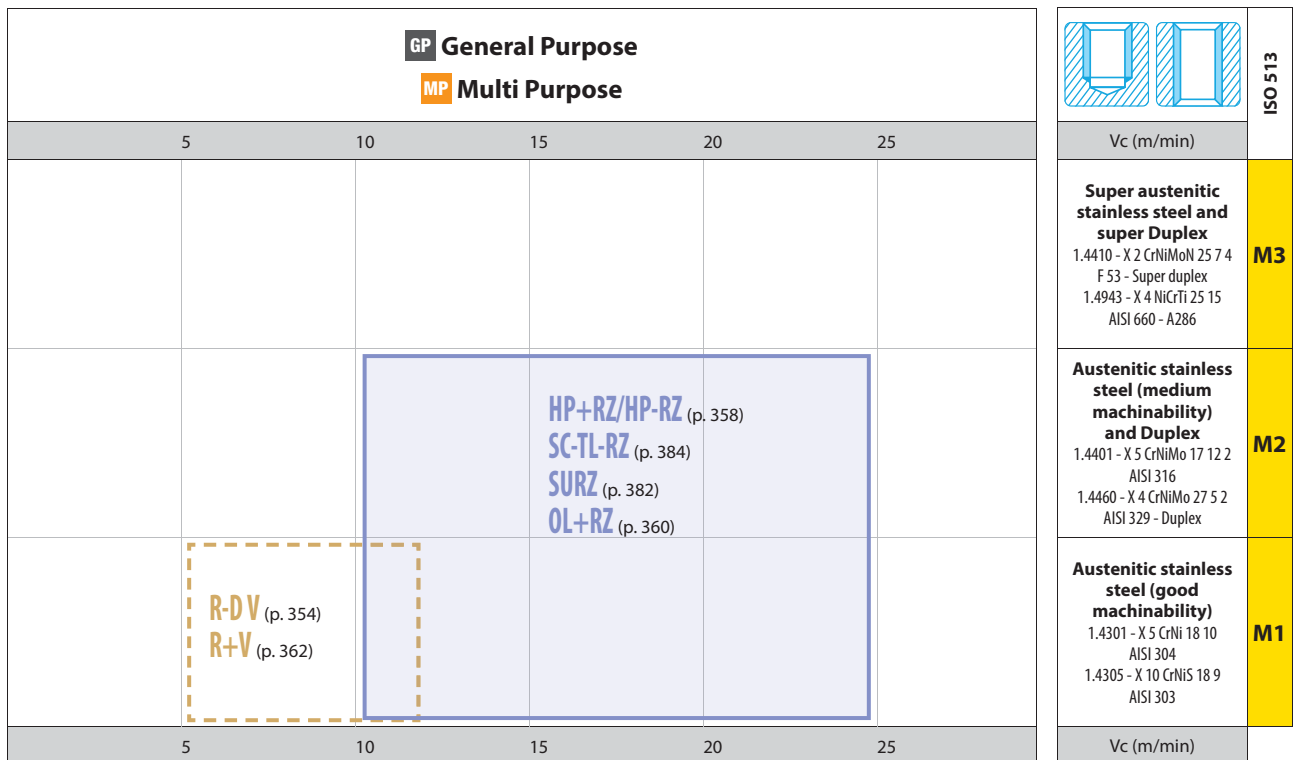

Most suitable
 Suitable

- SP
- SL
- PO
- ST
- ROLL
- CARBIDE
- LONG
- HAND TAPS
- EG (STI)
- SPECIAL THREADS, GAUGES
- THREAD MILLS
- DIES
- CENTER DRILLS
- Technical info

System Chart - ISO N

Grafici applicativi
 Anwendungstabellen
 Graphiques d'application
 Gráficos de aplicación
 Диаграммы области применения

Intro

FORMING TAPS

SP

SL

PO

ST

ROLL

CARBIDE

LONG

HAND TAPS

EG (STI)

SPECIAL THREADS, GAUGES

THREAD MILLS

DIES

CENTER DRILLS

Technical info

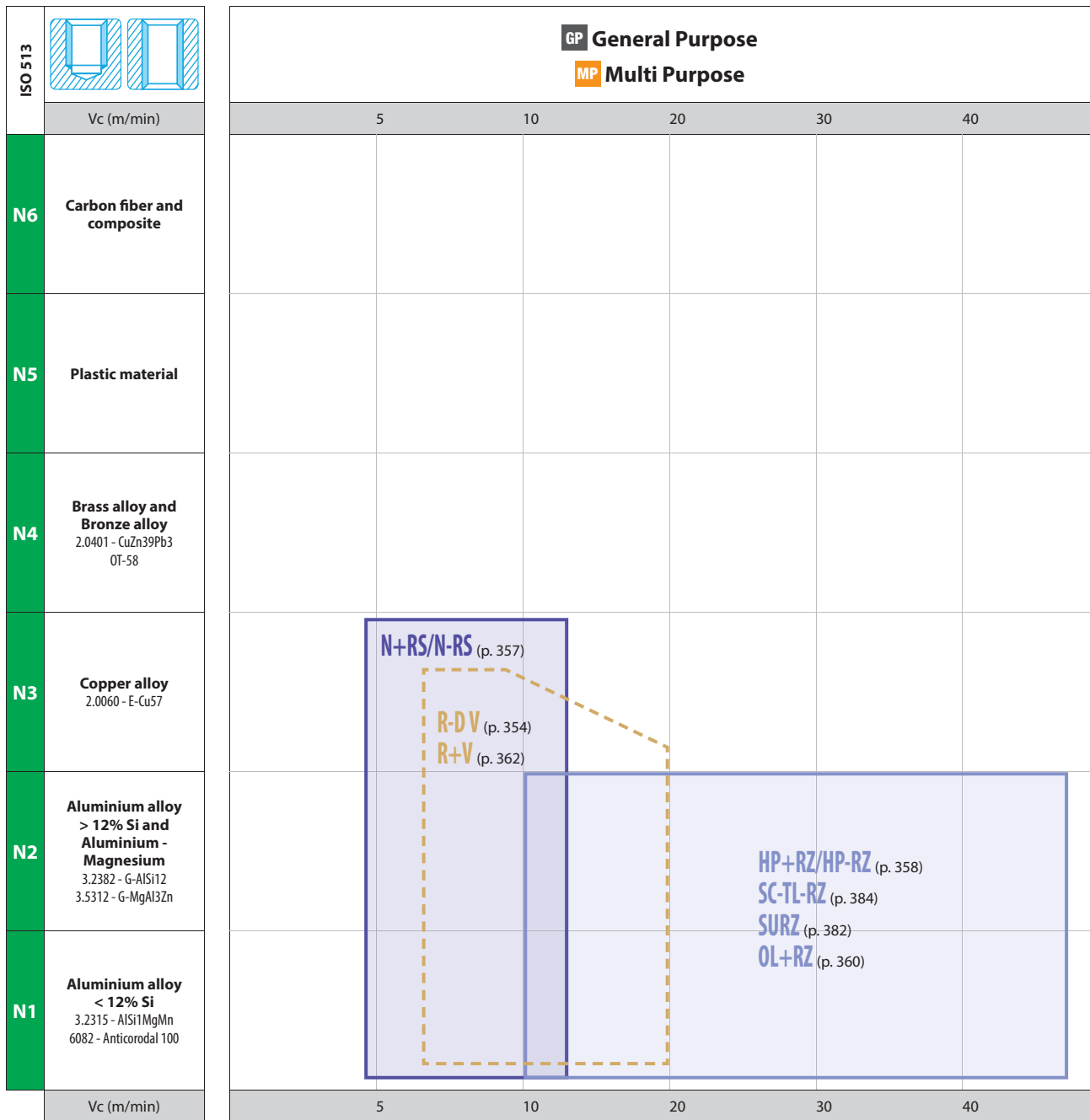

Most suitable
 Suitable

LINE-UP ARRANGED BY TYPE OF THREAD

M	46	NPS	64
MF	51	NPSF	64
M-MF	55	BSW	64
UNC	56	EG(STI) M	65
UNF	58	EG(STI) MF	65
UNC-UNF	59	EG(STI) UNC	66
UNS	60	EG(STI) UNF	66
8UN	60	Pg	66
12UN	60	Tr	67
20UN	61	S Miniature	67
32UN	61	TRI	67
UNEF	61	RLS	67
G(BSP)	61	V	67
Rp(BSPP)	63	CTV	67
Rc(BSPT)	63	BC	68
NPT	63	CTC	68
NPTF	64	CTG	68

LineUp arranged by type of thread

Intro

M

SP

SP - Spiral fluted taps



SL

PO

Z-PRO		DIN	81
VUSP		JIS	
		ANSI	
M 3 ÷ 16		YMW	
HSSP Spiral Fluted Taps, Coated			

ST

Z-PRO		DIN	83
VUSP E(1.5P)		JIS	
		ANSI	
M 3 ÷ 16		YMW	
HSSP Spiral Fluted Taps 1.5P, Coated			

ROLL

Z-PRO		DIN	89
HVSP		JIS	
		ANSI	
M 12 ÷ 48		YMW	
Spiral Fluted Taps for large forged parts in the heavy metalworking industry			

CARBIDE

Z-PRO		DIN	93
MHSP		JIS	
		ANSI	
M 8 ÷ 16		YMW	
Spiral Fluted Taps for Carbon Steel of Medium Hardness, Coated			

LONG

GENERAL PURPOSE		DIN	95
SP		JIS	152
		ANSI	
M 1.2 ÷ 64		YMW	
Spiral Fluted Taps			

HAND TAPS

GENERAL PURPOSE		DIN	95
SP ISO3(6G)		JIS	
		ANSI	
M 1.2 ÷ 64		YMW	
Spiral Fluted Taps			

EG (STI)

GENERAL PURPOSE		DIN	95
SP ISO2(6H)+50		JIS	
		ANSI	
M 1.2 ÷ 64		YMW	
Spiral Fluted Taps			

SPECIAL THREADS, GAUGES

GENERAL PURPOSE		DIN	95
SP ISO2(6H)+100		JIS	
		ANSI	
M 1.2 ÷ 64		YMW	
Spiral Fluted Taps			

THREAD MILLS

DIES

GENERAL PURPOSE		DIN	101
SP-BLF		JIS	
		ANSI	
M 3 ÷ 24		YMW	
Spiral Fluted Taps, Deep Hole Use			

CENTER DRILLS

GENERAL PURPOSE		DIN	
SP 1.5P		JIS	161
		ANSI	
M 1.2 ÷ 16		YMW	
Spiral Fluted Taps 1.5P			

Technical info

GENERAL PURPOSE		DIN	103
SP-BLF 1.5P		JIS	
		ANSI	
M 4 ÷ 12		YMW	
Spiral Fluted Taps 1.5P, Deep Hole Use			

GENERAL PURPOSE		DIN	105
SP LH		JIS	162
		ANSI	
M 2 ÷ 30		YMW	
Spiral Fluted Taps for Left Hand Threads			

GENERAL PURPOSE		DIN	107
SP-BLF OX		JIS	
		ANSI	
M 3 ÷ 36		YMW	
Spiral Fluted Taps, Deep Hole Use, Oxidized			

GENERAL PURPOSE		DIN	113
SP-BLF V		JIS	
		ANSI	
M 3 ÷ 24		YMW	
Spiral Fluted Taps, Deep Hole Use, Coated			

GENERAL PURPOSE		DIN	117
LO-SP		JIS	
		ANSI	
M 3 ÷ 16		YMW	
Low Spiral Fluted Taps			

GENERAL PURPOSE		DIN	118
LO-SP OX		JIS	
		ANSI	
M 3 ÷ 30		YMW	
Low Spiral Fluted Taps, Oxidized			

MULTI PURPOSE		DIN	121
AU+SP		JIS	
		ANSI	
M 3 ÷ 20		YMW	
Plus Series Spiral Fluted Taps, Coated			

MULTI PURPOSE		DIN	123
AUXSP		JIS	
		ANSI	
M 6 ÷ 12		YMW	
X Series Spiral Fluted Taps, Coated			

MATERIAL SPECIFIC		DIN	125
PH-SP		JIS	
		ANSI	
M 3 ÷ 30		YMW	
Spiral Fluted Taps for Hard Materials (<35HRC)			

MATERIAL SPECIFIC		DIN	127
PM-SP		JIS	
		ANSI	
M 3 ÷ 30		YMW	
Spiral Fluted Taps for Hard Materials (<45HRC)			

MATERIAL SPECIFIC		DIN	131
SP+VA		JIS	
		ANSI	
M 3 ÷ 12		YMW	
Plus Series Spiral Fluted Taps for Stainless Steel			

MATERIAL SPECIFIC		DIN	133
SP-VA		JIS	
		ANSI	
M 2 ÷ 36		YMW	
Spiral Fluted Taps for Stainless Steel			

MATERIAL SPECIFIC	 YAMAWA	DIN	
SU+SP/SU-SP		JIS	164
		ANSI	
M 1.4 ÷ 48		YMW	
Spiral Fluted Taps for Stainless Steel			

MATERIAL SPECIFIC	 YAMAWA	DIN	133
SP-VA ISO3(6G)		JIS	
		ANSI	
M 2 ÷ 36		YMW	
Spiral Fluted Taps for Stainless Steel			

MATERIAL SPECIFIC	 YAMAWA	DIN	137
SP-VA TiCN		JIS	
		ANSI	
M 3 ÷ 20		YMW	
Spiral Fluted Taps for Stainless Steel, Coated			

MATERIAL SPECIFIC	 YAMAWA	DIN	139
SU2-SP		JIS	
		ANSI	
M 3 ÷ 24		YMW	
Spiral Fluted Taps for Tough Stainless Steel			

MATERIAL SPECIFIC	 YAMAWA	DIN	141
AL+SP/AL-SP		JIS	169
		ANSI	
M 2 ÷ 16		YMW	
Spiral Fluted Taps for Aluminium			

MATERIAL SPECIFIC	 YAMAWA	DIN	
AL-SP 1.5P		JIS	171
		ANSI	
M 2 ÷ 16		YMW	
Spiral Fluted Taps for Aluminium 1.5P			

MATERIAL SPECIFIC	 YAMAWA	DIN	142
ZEN-B		JIS	
		ANSI	
M 3 ÷ 24		YMW	
Spiral Fluted Taps for Nickel Base Alloys			

MATERIAL SPECIFIC	 YAMAWA	DIN	144
ZET-B		JIS	
		ANSI	
M 2 ÷ 24		YMW	
Low Spiral Fluted Taps for Titanium Base Alloys			

HIGH SPEED	 YAMAWA	DIN	146
F-SP		JIS	
		ANSI	
M 3 ÷ 12		YMW	
Spiral Fluted Taps for High Speed Tapping, Coated			

HIGH SPEED	 YAMAWA	DIN	147
HFIHS		JIS	
		ANSI	
M 6 ÷ 16		YMW	
Spiral Fluted Taps with Axial Coolant Hole for Ultra Fast Tapping, Coated			

HIGH SPEED	 YAMAWA	DIN	148
HFISP		JIS	
		ANSI	
M 6 ÷ 16		YMW	
Low Spiral Fluted Taps with Axial Coolant Hole for Ultra Fast Tapping, Coated			

HIGH SPEED	 YAMAWA	DIN	149
HFAHS		JIS	
		ANSI	
M 6 ÷ 12		YMW	
Spiral Fluted Taps with Axial Coolant Hole for Ultra Fast Tapping, Coated			

HIGH SPEED	 YAMAWA	DIN	151
HFASP		JIS	
		ANSI	
M 6 ÷ 12		YMW	
Low Spiral Fluted Taps with Axial Coolant Hole for Ultra Fast Tapping, Coated			

SL - Left spiral fluted taps

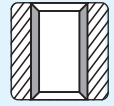

Z-PRO	 YAMAWA	DIN	195
MHSL		JIS	
		ANSI	
M 6 ÷ 12		YMW	
Left Spiral Fluted Taps for Carbon Steel of Medium Hardness, Coated			

MULTI PURPOSE	 YAMAWA	DIN	197
AU+SL		JIS	
		ANSI	
M 3 ÷ 20		YMW	
Plus Series Left Spiral Fluted Taps, Coated			

MULTI PURPOSE	 YAMAWA	DIN	198
AUXSL		JIS	
		ANSI	
M 6 ÷ 12		YMW	
X Series Left Spiral Fluted Taps, Coated			

MATERIAL SPECIFIC	 YAMAWA	DIN	199
SL+VA		JIS	
		ANSI	
M 3 ÷ 12		YMW	
Plus Series Left Spiral Fluted Taps for Stainless Steel			

MATERIAL SPECIFIC	 YAMAWA	DIN	201
ZET-P		JIS	
		ANSI	
M 3 ÷ 16		YMW	
Left Spiral Fluted Taps for Titanium Base Alloys			

HIGH SPEED	 YAMAWA	DIN	202
F-SL		JIS	
		ANSI	
M 3 ÷ 12		YMW	
Left Spiral Fluted Taps for High Speed Tapping, Coated			

HIGH SPEED	 YAMAWA	DIN	203
HDISL		JIS	
		ANSI	
M 6 ÷ 20		YMW	
Left Spiral Fluted Taps with Radial Coolant Holes for Ultra High Speed Tapping, Coated			

PO - Spiral pointed taps

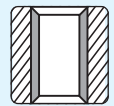

Z-PRO	 YAMAWA	DIN	211
VUPO		JIS	
		ANSI	
M 3 ÷ 16		YMW	
HSSP Spiral Pointed Taps, Coated			

GENERAL PURPOSE	 YAMAWA	DIN	213
PO		JIS	233
		ANSI	
M 1.2 ÷ 48		YMW	
Spiral Pointed Taps			

SP

SL

PO

ST

ROLL

CARBIDE

LONG

HAND TAPS

EG (STI)

SPECIAL THREADS, GAUGES

THREAD MILLS

DIES

CENTER DRILLS

Technical info

LineUp arranged by type of thread

Intro

SP

GENERAL PURPOSE		DIN	213
PO ISO3(6G)		JIS	
M 1.2 ÷ 48	Spiral Pointed Taps	ANSI	
		YMW	

SL

GENERAL PURPOSE		DIN	213
PO ISO2(6H)+100		JIS	
M 1.2 ÷ 48	Spiral Pointed Taps	ANSI	
		YMW	

PO

GENERAL PURPOSE		DIN	
PO LH		JIS	240
M 3 ÷ 30	Spiral Pointed Taps for Left Hand Threads	ANSI	
		YMW	

ST

GENERAL PURPOSE		DIN	219
PO OX		JIS	
M 3 ÷ 20	Spiral Pointed Taps, Oxided	ANSI	
		YMW	

ROLL

GENERAL PURPOSE		DIN	221
PO V		JIS	
M 3 ÷ 24	Spiral Pointed Taps, Coated	ANSI	
		YMW	

CARBIDE

MATERIAL SPECIFIC		DIN	223
PM-PO		JIS	
M 3 ÷ 30	Spiral Pointed Taps for Hard Materials (<45HRC)	ANSI	
		YMW	

LONG

MATERIAL SPECIFIC		DIN	225
EH-PO		JIS	
M 3 ÷ 24	Spiral Pointed Taps for Hard Materials (<45HRC)	ANSI	
		YMW	

HAND TAPS

MATERIAL SPECIFIC		DIN	227
PO-VA		JIS	
M 2 ÷ 36	Spiral Pointed Taps for Stainless Steel	ANSI	
		YMW	

EG (STI)

MATERIAL SPECIFIC		DIN	
SU+PO/SU-PO		JIS	242
M 1.4 ÷ 42	Spiral Pointed Taps for Stainless Steel	ANSI	
		YMW	

SPECIAL THREADS, GAUGES

THREAD MILLS

MATERIAL SPECIFIC		DIN	229
PO-VA TiCN		JIS	
M 3 ÷ 20	Spiral Pointed Taps for Stainless Steel, Coated	ANSI	
		YMW	

DIES

MATERIAL SPECIFIC		DIN	230
ZEN-P		JIS	
M 3 ÷ 24	Spiral Pointed Taps for Nickel Base Alloys	ANSI	
		YMW	

CENTER DRILLS

Technical info

ST - Straight fluted taps

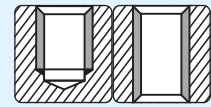



Z-PRO		DIN	265
GGST		JIS	
M 3 ÷ 24	Straight Fluted Taps for Cast Iron, Coated	ANSI	
		YMW	

Z-PRO		DIN	267
GGST CH		JIS	
M 6 ÷ 20	Straight Fluted Taps for Cast Iron with Axial Coolant Hole, Coated	ANSI	
		YMW	

Z-PRO		DIN	269
GGST CH E(1.5P)		JIS	
M 6 ÷ 16	Straight Fluted Taps 1.5P, for Cast Iron with Axial Coolant Hole, Coated	ANSI	
		YMW	

GENERAL PURPOSE		DIN	271
HT		JIS	289
M 1 ÷ 100	Straight Fluted Taps	ANSI	
		YMW	

GENERAL PURPOSE		DIN	
HT LH		JIS	315
M 1 ÷ 48	Straight Fluted Taps for Left Hand Threads	ANSI	
		YMW	

MATERIAL SPECIFIC		DIN	275
EH-HT		JIS	
M 3 ÷ 24	Straight Fluted Taps for Hard Materials (<45HRC)	ANSI	
		YMW	

MATERIAL SPECIFIC		DIN	
SU-HT		JIS	325
M 2 ÷ 30	Straight Fluted Taps for Stainless Steel	ANSI	
		YMW	

MATERIAL SPECIFIC		DIN	279
GG-HT		JIS	
M 3 ÷ 24	Straight Fluted Taps for Cast Iron	ANSI	
		YMW	

MATERIAL SPECIFIC		DIN	281
GG-HT TiCN		JIS	
M 3 ÷ 24	Straight Fluted Taps for Cast Iron, Coated	ANSI	
		YMW	

MATERIAL SPECIFIC		DIN	283
GG-HT-OH TiCN		JIS	
M 6 ÷ 20	Straight Fluted Taps for Cast Iron with Axial Coolant Hole, Coated	ANSI	
		YMW	

MATERIAL SPECIFIC		DIN	285
LA-HT		JIS	329
M 1.4 ÷ 24	Straight Fluted Taps for Die Cast Materials	ANSI	
		YMW	

MATERIAL SPECIFIC		DIN	287
AXE-HT		JIS	
		ANSI	
M 6 ÷ 12		YMW	

MATERIAL SPECIFIC		DIN	
MG-HT		JIS	331
		ANSI	
M 1.4 ÷ 3		YMW	

MATERIAL SPECIFIC		DIN	
PL1		JIS	333
		ANSI	
M 2 ÷ 8		YMW	

MULTI PURPOSE		DIN	
SURZ		JIS	383
		ANSI	
M 1 ÷ 3		YMW	

MULTI PURPOSE		DIN	
SC-TL-RZ		JIS	385
		ANSI	
M 1 ÷ 6		YMW	

MULTI PURPOSE		DIN	361
OL+RZ/OL-RZ		JIS	386
		ANSI	
M 1 ÷ 6		YMW	

ROLL - Forming taps

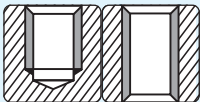

Z-PRO		DIN	351
MHRZ		JIS	
		ANSI	
M 6 ÷ 12		YMW	

GENERAL PURPOSE		DIN	353
R-D		JIS	
		ANSI	
M 2 ÷ 16		YMW	

GENERAL PURPOSE		DIN	355
R-D V		JIS	
		ANSI	
M 2 ÷ 16		YMW	

GENERAL PURPOSE		DIN	
R+V		JIS	363
		ANSI	
M 1 ÷ 6		YMW	

GENERAL PURPOSE		DIN	356
N+RZ/N-RZ		JIS	367
		ANSI	
M 1 ÷ 16		YMW	

GENERAL PURPOSE		DIN	357
N+RS/N-RS		JIS	372
		ANSI	
M 1 ÷ 20		YMW	

MULTI PURPOSE		DIN	359
HP+RZ/HP-RZ		JIS	379
		ANSI	
M 1 ÷ 16		YMW	

MULTI PURPOSE		DIN	359
HP+RZ/HP-RZ ISO3X(6GX)		JIS	
		ANSI	
M 1 ÷ 16		YMW	

CT - Carbide taps

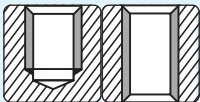

MATERIAL SPECIFIC		DIN	395
CT FC		JIS	
		ANSI	
M 3 ÷ M12		YMW	

MATERIAL SPECIFIC		DIN	
N-CT FC		JIS	403
		ANSI	
M 1.4 ÷ M30		YMW	

MATERIAL SPECIFIC		DIN	
LS-N-CT		JIS	408
		ANSI	
M 3 ÷ 24		YMW	

MATERIAL SPECIFIC		DIN	
N-CT-SP		JIS	411
		ANSI	
M 3 ÷ 20		YMW	

MATERIAL SPECIFIC		DIN	
N-CT-PO		JIS	413
		ANSI	
M 3 ÷ 12		YMW	

MATERIAL SPECIFIC		DIN	397
CT LA		JIS	
		ANSI	
M 3 ÷ M12		YMW	

MATERIAL SPECIFIC		DIN	
N-CT LA		JIS	415
		ANSI	
M 1.4 ÷ 20		YMW	

MATERIAL SPECIFIC		DIN	
ACHSP		JIS	421
		ANSI	
M 6 ÷ 10		YMW	

SP

SL

PO

ST

ROLL

CARBIDE

LONG

HAND TAPS

EG (STI)

SPECIAL THREADS, GAUGES

THREAD MILLS

DIES

CENTER DRILLS

Technical info

LineUp arranged by type of thread

Intro

SP

MATERIAL SPECIFIC		DIN	
MC-AD-CT		JIS	419
M 6 ÷ 12		Carbide Taps with Axial Coolant Hole, Coated	

GENERAL PURPOSE		DIN	
MC-SP		JIS	442
M 6 ÷ 30		Long Shank Spiral Fluted Taps with Axial Coolant Hole	

SL

MATERIAL SPECIFIC		DIN	399
EH-CT		JIS	
M 3 ÷ M12		Carbide Taps for Hard Materials (<55HRC), Coated	

MATERIAL SPECIFIC		DIN	
LS-PM-SP		JIS	445
M 3 ÷ 30		Long Shank Spiral Fluted Taps for Hard Materials (<45HRC)	

PO

MATERIAL SPECIFIC		DIN	401
UH-CT		JIS	
M 3 ÷ M20		Carbide Taps for Ultra Hard Materials (<63HRC), Coated	

MATERIAL SPECIFIC		DIN	
LS-SU-S-SP		JIS	447
M 3 ÷ 24		Long Shank Spiral Fluted Taps for Stainless Steel	

ST

HIGH SPEED		DIN	
HFICT-B		JIS	422
M 6 ÷ 12		Carbide Taps with Axial Coolant Hole for Cast Iron Ultra Fast Tapping, Coated	

GENERAL PURPOSE		DIN	
LS-PO		JIS	449
M 2 ÷ 30		Long Shank Spiral Pointed Taps	

ROLL

HIGH SPEED		DIN	
HFICT-P		JIS	423
M 6 ÷ 12		Carbide Taps with Radial Coolant Holes for Cast Iron Ultra Fast Tapping, Coated	

GENERAL PURPOSE		DIN	
LS-PO-K		JIS	454
M 3 ÷ 6		Long Shank Spiral Pointed Taps with Long Neck	

CARBIDE

HIGH SPEED		DIN	
HFACT-B		JIS	424
M 6 ÷ 12		Carbide Taps with Axial Coolant Hole for Non-Ferrous Materials Ultra Fast Tapping, Coated	

GENERAL PURPOSE		DIN	
LS-PO V		JIS	455
M 3 ÷ 12		Long Shank Spiral Pointed Taps, Coated	

LONG

HIGH SPEED		DIN	
HFACT-P		JIS	425
M 6 ÷ 12		Carbide Taps with Radial Coolant Holes for Non-Ferrous Materials Ultra Fast Tapping, Coated	

GENERAL PURPOSE		DIN	
MC-PO		JIS	456
M 6 ÷ 30		Long Shank Spiral Pointed Taps with Radial Coolant Holes	

HAND TAPS

EG (STI)

LONG - Long shank taps

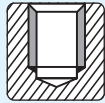

SPECIAL THREADS, GAUGES

GENERAL PURPOSE		DIN	
LS-SP		JIS	433
M 2 ÷ 30		Long Shank Spiral Fluted Taps	

MATERIAL SPECIFIC		DIN	
LS-PM-PO		JIS	459
M 3 ÷ 30		Long Shank Spiral Pointed Taps for Hard Materials (<45HRC)	

THREAD MILLS

GENERAL PURPOSE		DIN	
LS-SP-K		JIS	439
M 3 ÷ 6		Long Shank Spiral Fluted Taps with Long Neck	

GENERAL PURPOSE		DIN	
LS-HT		JIS	463
M 2 ÷ 48		Long Shank Straight Fluted Taps	

DIES

GENERAL PURPOSE		DIN	
LS-SP LH		JIS	440
M 3 ÷ 16		Long Shank Spiral Fluted Taps for Left Hand Threads	

GENERAL PURPOSE		DIN	
LS-HT LH		JIS	481
M 3 ÷ 30		Long Shank Straight Fluted Taps for Left Hand Threads	

CENTER DRILLS

GENERAL PURPOSE		DIN	
LS-SP V		JIS	441
M 3 ÷ 12		Long Shank Spiral Fluted Taps, coated	

GENERAL PURPOSE		DIN	
LS-HT V		JIS	485
M 3 ÷ 12		Long Shank Straight Fluted Taps, Coated	

Technical info

GENERAL PURPOSE		DIN	
MC-HT		JIS	487
		ANSI	
M 6 ÷ 30	Long Shank Straight Fluted Taps with Axial (Blind) and Radial (Through) Coolant Holes	YMW	

GENERAL PURPOSE		DIN	
LS-N-RZ		JIS	491
		ANSI	
M 3 ÷ 10	Long Shank Thread Forming Taps for Steel	YMW	

GENERAL PURPOSE		DIN	
LS-N-RS		JIS	493
		ANSI	
M 3 ÷ 10	Long Shank Thread Forming Taps for Non-Ferrous Materials	YMW	

HAND TAPS - Taps for hand and drilling machine application

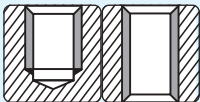

HAND TAPS		DIN	499
6110		JIS	
		ANSI	
M 2 ÷ 24	Serial taps for manual use	YMW	

HAND TAPS		DIN	501
HT DIN352		JIS	
		ANSI	
M 2 ÷ 24	Straight Fluted Taps for manual and drilling machine use	YMW	

HAND TAPS		DIN	
ISP		JIS	504
		ANSI	
M 3 ÷ 10	Spiral Fluted Taps for manual and drilling machine use	YMW	

HAND TAPS		DIN	
IPO		JIS	505
		ANSI	
M 3 ÷ 10	Spiral Pointed Taps for manual drilling machine use	YMW	

HAND TAPS		DIN	
IHT		JIS	506
		ANSI	
M 3 ÷ 10	Straight Fluted Taps for manual and drilling machine use	YMW	

Special threads, gauges

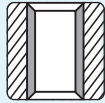

GENERAL PURPOSE		DIN	537
6000		JIS	
		ANSI	
M 3 ÷ 10	Nut Taps	YMW	

GENERAL PURPOSE		DIN	
NT		JIS	539
		ANSI	
M 2 ÷ 42	Nut Taps	YMW	

Dies

DIES		DIN	594
DPO		JIS	
		ANSI	
M 1 ÷ 36	HSS Spiral Pointed Dies	YMW	

DIES		DIN	
HS-D		JIS	599
		ANSI	
M 1 ÷ 10	HSS Round Dies for Automatic Lathe for Stainless Steel	YMW	

MF

SP - Spiral fluted taps

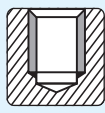

Z-PRO		DIN	81
VUSP		JIS	
		ANSI	
MF 3 ÷ 16	HSSP Spiral Fluted Taps, Coated	YMW	

Z-PRO		DIN	83
VUSP E(1.5P)		JIS	
		ANSI	
MF 3 ÷ 16	HSSP Spiral Fluted Taps 1.5P, Coated	YMW	

Z-PRO		DIN	89
HVSP		JIS	
		ANSI	
MF 30 ÷ 48	Spiral Fluted Taps for large forged parts in the heavy metalworking industry	YMW	

Z-PRO		DIN	93
MHSP		JIS	
		ANSI	
MF 10 ÷ 16	Spiral Fluted Taps for Carbon Steel of Medium Hardness, Coated	YMW	

GENERAL PURPOSE		DIN	96
SP		JIS	154
		ANSI	
M 2 ÷ 48	Spiral Fluted Taps	YMW	

GENERAL PURPOSE		DIN	
SP 1.5P		JIS	161
		ANSI	
MF 8 ÷ 16	Spiral Fluted Taps 1.5P	YMW	

GENERAL PURPOSE		DIN	105
SP LH		JIS	163
		ANSI	
MF 8 ÷ 30	Spiral Fluted Taps for Left Hand Threads	YMW	

SP

SL

PO

ST

ROLL

CARBIDE

LONG

HAND TAPS

EG (STI)

SPECIAL THREADS, GAUGES

THREAD MILLS

DIES

CENTER DRILLS

Technical info

LineUp arranged by type of thread

Intro

GENERAL PURPOSE		DIN	109
SP OX		JIS	
MF 4 ÷ 48	Spiral Fluted Taps, Oxided	ANSI	
		YMW	

MATERIAL SPECIFIC		DIN	145
ZET-B		JIS	
MF 10 ÷ 16	Low Spiral Fluted Taps for Titanium Base Alloys	ANSI	
		YMW	

SP

GENERAL PURPOSE		DIN	115
SP V		JIS	
MF 8 ÷ 20	Spiral Fluted Taps, Coated	ANSI	
		YMW	

HIGH SPEED		DIN	146
F-SP		JIS	
MF 10 ÷ 12	Spiral Fluted Taps for High Speed Tapping, Coated	ANSI	
		YMW	

SL

GENERAL PURPOSE		DIN	117
LO-SP		JIS	
MF 8 ÷ 16	Low Spiral Fluted Taps	ANSI	
		YMW	

HIGH SPEED		DIN	147
HFHS		JIS	
MF 10 ÷ 16	Spiral Fluted Taps with Axial Coolant Hole for Ultra Fast Tapping, Coated	ANSI	
		YMW	

PO

GENERAL PURPOSE		DIN	119
LO-SP OX		JIS	
MF 8 ÷ 30	Low Spiral Fluted Taps, Oxided	ANSI	
		YMW	

HIGH SPEED		DIN	148
HFISP		JIS	
MF 10 ÷ 18	Low Spiral Fluted Taps with Axial Coolant Hole for Ultra Fast Tapping, Coated	ANSI	
		YMW	

ST

MULTI PURPOSE		DIN	121
AU+SP		JIS	
MF 8 ÷ 20	Plus Series Spiral Fluted Taps, Coated	ANSI	
		YMW	

HIGH SPEED		DIN	149
HFAHS		JIS	
MF 10 ÷ 12	Spiral Fluted Taps with Axial Coolant Hole for Ultra Fast Tapping, Coated	ANSI	
		YMW	

ROLL

MATERIAL SPECIFIC		DIN	125
PH-SP		JIS	
MF 8 ÷ 30	Spiral Fluted Taps for Hard Materials (<35HRC)	ANSI	
		YMW	

HIGH SPEED		DIN	151
HFASP		JIS	
MF 10 ÷ 12	Low Spiral Fluted Taps with Axial Coolant Hole for Ultra Fast Tapping, Coated	ANSI	
		YMW	

CARBIDE

LONG

MATERIAL SPECIFIC		DIN	127
PM-SP		JIS	
MF 8 ÷ 30	Spiral Fluted Taps for Hard Materials (<45HRC)	ANSI	
		YMW	

SL - Left spiral fluted taps

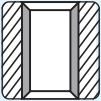

HAND TAPS

MATERIAL SPECIFIC		DIN	133
SP-VA		JIS	
MF 6 ÷ 30	Spiral Fluted Taps for Stainless Steel	ANSI	
		YMW	

Z-PRO		DIN	195
MHSL		JIS	
MF 10 ÷ 16	Left Spiral Fluted Taps for Carbon Steel of Medium Hardness, Coated	ANSI	
		YMW	

EG (STI)

MATERIAL SPECIFIC		DIN	166
SU+SP/SU-SP		JIS	
MF 6 ÷ 42	Spiral Fluted Taps for Stainless Steel	ANSI	
		YMW	

MULTI PURPOSE		DIN	197
AU+SL		JIS	
MF 8 ÷ 20	Plus Series Left Spiral Fluted Taps, Coated	ANSI	
		YMW	

SPECIAL THREADS, GAUGES

MATERIAL SPECIFIC		DIN	169
AL+SP/AL-SP		JIS	
MF 10 ÷ 16	Spiral Fluted Taps for Aluminium	ANSI	
		YMW	

MATERIAL SPECIFIC		DIN	201
ZET-P		JIS	
MF 10 ÷ 16	Left Spiral Fluted Taps for Titanium Base Alloys	ANSI	
		YMW	

THREAD MILLS

MATERIAL SPECIFIC		DIN	171
AL-SP 1.5P		JIS	
MF 10 ÷ 16	Spiral Fluted Taps for Aluminium 1.5P	ANSI	
		YMW	

HIGH SPEED		DIN	202
F-SL		JIS	
MF 10 ÷ 12	Left Spiral Fluted Taps for High Speed Tapping, Coated	ANSI	
		YMW	

DIES

MATERIAL SPECIFIC		DIN	143
ZEN-B		JIS	
MF 10 ÷ 16	Spiral Fluted Taps for Nickel Base Alloys	ANSI	
		YMW	

HIGH SPEED		DIN	203
HDISL		JIS	
MF 10 ÷ 16	Left Spiral Fluted Taps with Radial Coolant Holes for Ultra High Speed Tapping, Coated	ANSI	
		YMW	

CENTER DRILLS

Technical info

PO - Spiral pointed taps

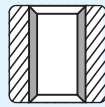



Z-PRO	 HSSP Spiral Pointed Taps, Coated	DIN	211
VUPO		JIS	
		ANSI	
MF 3 ÷ 16		YMW	

GENERAL PURPOSE	 Spiral Pointed Taps	DIN	214
PO		JIS	234
		ANSI	
MF 2 ÷ 50		YMW	

GENERAL PURPOSE	 Spiral Pointed Taps for Left Hand Threads	DIN	
PO LH		JIS	241
		ANSI	
MF 8 ÷ 30		YMW	

GENERAL PURPOSE	 Spiral Pointed Taps, Coated	DIN	221
PO V		JIS	
		ANSI	
MF 8 ÷ 20		YMW	

MATERIAL SPECIFIC	 Spiral Pointed Taps for Hard Materials (<45HRC)	DIN	223
PM-PO		JIS	
		ANSI	
MF 8 ÷ 30		YMW	

MATERIAL SPECIFIC	 Spiral Pointed Taps for Hard Materials (<45HRC)	DIN	225
EH-PO		JIS	
		ANSI	
MF 8 ÷ 20		YMW	

MATERIAL SPECIFIC	 Spiral Pointed Taps for Stainless Steel	DIN	227
PO-VA		JIS	
		ANSI	
MF 8 ÷ 24		YMW	

MATERIAL SPECIFIC	 Spiral Pointed Taps for Stainless Steel	DIN	
SU+PO/SU-PO		JIS	244
		ANSI	
MF 6 ÷ 30		YMW	

MATERIAL SPECIFIC	 Spiral Pointed Taps for Nickel Base Alloys	DIN	231
ZEN-P		JIS	
		ANSI	
MF 10 ÷ 16		YMW	

ST - Straight fluted taps

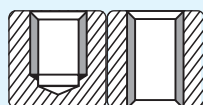



Z-PRO	 Straight Fluted Taps for Cast Iron, Coated	DIN	265
GGST		JIS	
		ANSI	
MF 8 ÷ 24		YMW	

Z-PRO	 Straight Fluted Taps for Cast Iron with Axial Coolant Hole, Coated	DIN	267
GGST CH		JIS	
		ANSI	
MF 8 ÷ 20		YMW	

Z-PRO	 Straight Fluted Taps 1.5P, for Cast Iron with Axial Coolant Hole, Coated	DIN	269
GGST CH E(1.5P)		JIS	
		ANSI	
MF 10 ÷ 16		YMW	

GENERAL PURPOSE	 Straight Fluted Taps	DIN	271
HT		JIS	293
		ANSI	
MF 1 ÷ 100		YMW	

GENERAL PURPOSE	 Straight Fluted Taps for Left Hand Threads	DIN	
HT LH		JIS	316
		ANSI	
MF 3 ÷ 50		YMW	

GENERAL PURPOSE	 Straight Fluted Taps for Hard Materials (<45HRC)	DIN	275
EH-HT		JIS	
		ANSI	
MF 8 ÷ 20		YMW	

MATERIAL SPECIFIC	 Straight Fluted Taps for Stainless Steel	DIN	
SU-HT		JIS	325
		ANSI	
M 6 ÷ 30		YMW	

MATERIAL SPECIFIC	 Straight Fluted Taps for Cast Iron	DIN	279
GG-HT		JIS	
		ANSI	
MF 8 ÷ 24		YMW	

MATERIAL SPECIFIC	 Straight Fluted Taps for Cast Iron, Coated	DIN	281
GG-HT TiCN		JIS	
		ANSI	
MF 8 ÷ 24		YMW	

MATERIAL SPECIFIC	 Straight Fluted Taps for Cast Iron with Axial Coolant Hole, Coated	DIN	283
GG-HT-OH TiCN		JIS	
		ANSI	
MF 8 ÷ 20		YMW	

MATERIAL SPECIFIC	 Straight Fluted Taps for Die Cast Materials	DIN	
LA-HT		JIS	329
		ANSI	
MF 8 ÷ 24		YMW	

MATERIAL SPECIFIC	 AXE Straight Fluted Taps for Die Cast Aluminum Alloys, Coated	DIN	287
AXE-HT		JIS	
		ANSI	
MF 10 ÷ 12		YMW	

LineUp arranged by type of thread

Intro

SP

ROLL - Forming taps

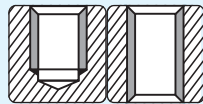

Z-PRO		DIN	351
MHRZ		JIS	
MF 10 ÷ 20	Roll Taps for Carbon Steel of Medium Hardness, Coated	ANSI	
		YMW	

SL

GENERAL PURPOSE		DIN	
N+RZ/N-RZ		JIS	369
MF 2 ÷ 20	Thread Forming Taps for Steel	ANSI	
		YMW	

PO

ST

GENERAL PURPOSE		DIN	
N+RS/N-RS		JIS	375
MF 2 ÷ 20	Thread Forming Taps for Non-Ferrous Materials	ANSI	
		YMW	

ROLL

MULTI PURPOSE		DIN	359
HP+RZ/HP-RZ		JIS	380
MF 10 ÷ 20	High Performance Thread Forming Taps, Coated	ANSI	
		YMW	

CARBIDE

MULTI PURPOSE		DIN	
SURZ		JIS	383
MF 1.6	Thread Forming Taps for Stainless Steel, Coated	ANSI	
		YMW	

LONG

HAND TAPS

MULTI PURPOSE		DIN	
SC-TL-RZ		JIS	385
MF 1.4 ÷ 1.6	Torqueless Thread Forming Taps with short chamfer, Coated	ANSI	
		YMW	

EG (STI)

CT - Carbide taps

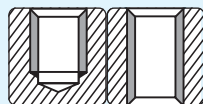

MATERIAL SPECIFIC		DIN	
N-CT FC		JIS	404
MF 3 ÷ M24	Carbide Taps for Cast Iron	ANSI	
		YMW	

SPECIAL THREADS, GAUGES

THREAD MILLS

MATERIAL SPECIFIC		DIN	
LS-N-CT		JIS	409
MF 10 ÷ 24	Long Shank Carbide Taps	ANSI	
		YMW	

DIES

MATERIAL SPECIFIC		DIN	
N-CT-SP		JIS	411
MF 10 ÷ 24	Carbide Taps Spiral Fluted for Non-Ferrous Materials	ANSI	
		YMW	

CENTER DRILLS

MATERIAL SPECIFIC		DIN	
N-CT LA		JIS	416
MF 4 ÷ 20	Carbide Taps for Light Alloys	ANSI	
		YMW	

Technical info

MATERIAL SPECIFIC		DIN	
ACHSP		JIS	421
MF 10	Carbide Taps Spiral Fluted with Axial Coolant Hole for Cored Holes in Aluminium, Coated	ANSI	
		YMW	

MATERIAL SPECIFIC		DIN	
MC-AD-CT		JIS	419
MF 10 ÷ 12	Carbide Taps with Axial Coolant Hole, Coated	ANSI	
		YMW	

HIGH SPEED		DIN	
HFICT-B		JIS	422
MF 10 ÷ 12	Carbide Taps with Axial Coolant Hole for Cast Iron Ultra Fast Tapping, Coated	ANSI	
		YMW	

HIGH SPEED		DIN	
HFICT-P		JIS	423
MF 10 ÷ 12	Carbide Taps with Radial Coolant Holes for Cast Iron Ultra Fast Tapping, Coated	ANSI	
		YMW	

HIGH SPEED		DIN	
HFACT-B		JIS	424
MF 10 ÷ 12	Carbide Taps with Axial Coolant Hole for Non-Ferrous Materials Ultra Fast Tapping, Coated	ANSI	
		YMW	

HIGH SPEED		DIN	
HFACT-P		JIS	425
MF 10 ÷ 12	Carbide Taps with Radial Coolant Holes for Non-Ferrous Materials Ultra Fast Tapping, Coated	ANSI	
		YMW	

LONG - Long shank taps

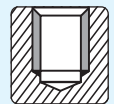

GENERAL PURPOSE		DIN	
LS-SP		JIS	434
MF 6 ÷ 30	Long Shank Spiral Fluted Taps	ANSI	
		YMW	

GENERAL PURPOSE		DIN	
LS-SP LH		JIS	440
MF 10 ÷ 16	Long Shank Spiral Fluted Taps for Left Hand Threads	ANSI	
		YMW	

GENERAL PURPOSE		DIN	
LS-SP V		JIS	441
MF 10 ÷ 12	Long Shank Spiral Fluted Taps, coated	ANSI	
		YMW	

GENERAL PURPOSE		DIN	
MC-SP		JIS	443
MF 10 ÷ 30	Long Shank Spiral Fluted Taps with Axial Coolant Hole	ANSI	
		YMW	

MATERIAL SPECIFIC		DIN	
LS-PM-SP		JIS	445
MF 10 ÷ 30	Long Shank Spiral Fluted Taps for Hard Materials (<45HRC)	ANSI	
		YMW	

MATERIAL SPECIFIC		DIN	
LS-SU-S-SP		JIS	447
		ANSI	
MF 10 ÷ 24		YMW	
Long Shank Spiral Fluted Taps for Stainless Steel			

GENERAL PURPOSE		DIN	
LS-PO		JIS	450
		ANSI	
MF 8 ÷ 30		YMW	
Long Shank Spiral Pointed Taps			

GENERAL PURPOSE		DIN	
LS-PO V		JIS	455
		ANSI	
MF 10 ÷ 12		YMW	
Long Shank Spiral Pointed Taps, Coated			

GENERAL PURPOSE		DIN	
MC-PO		JIS	457
		ANSI	
MF 10 ÷ 30		YMW	
Long Shank Spiral Pointed Taps with Radial Coolant Holes			

MATERIAL SPECIFIC		DIN	
LS-PM-PO		JIS	459
		ANSI	
MF 10 ÷ 30		YMW	
Long Shank Spiral Pointed Taps for Hard Materials (<45HRC)			

MATERIAL SPECIFIC		DIN	
LS-SU-S-PO		JIS	461
		ANSI	
MF 10 ÷ 24		YMW	
Long Shank Spiral Pointed Taps for Stainless Steel			

GENERAL PURPOSE		DIN	
LS-HT		JIS	467
		ANSI	
MF 8 ÷ 48		YMW	
Long Shank Straight Fluted Taps			

GENERAL PURPOSE		DIN	
LS-HT LH		JIS	482
		ANSI	
MF 10 ÷ 30		YMW	
Long Shank Straight Fluted Taps for Left Hand Threads			

GENERAL PURPOSE		DIN	
LS-HT V		JIS	485
		ANSI	
MF 10 ÷ 12		YMW	
Long Shank Straight Fluted Taps, Coated			

GENERAL PURPOSE		DIN	
MC-HT		JIS	488
		ANSI	
MF 10 ÷ 30		YMW	
Long Shank Straight Fluted Taps with Axial (Blind) and Radial (Through) Coolant Holes			

GENERAL PURPOSE		DIN	
LS-N-RZ		JIS	491
		ANSI	
MF 10		YMW	
Long Shank Thread Forming Taps for Steel			

GENERAL PURPOSE		DIN	
LS-N-RS		JIS	493
		ANSI	
MF 10		YMW	
Long Shank Thread Forming Taps for Non-Ferrous Materials			

Special threads, gauges

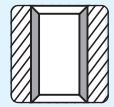

GENERAL PURPOSE		DIN	
NT		JIS	539
		ANSI	
MF 6 ÷ 30		YMW	
Nut Taps			

DIES		DIN	
HS-D		JIS	600
		ANSI	
MF 2 ÷ 10		YMW	
HSS Round Dies for Automatic Lathe for Stainless Steel			

Dies

DIES		DIN	595
DPO		JIS	
		ANSI	
MF 2 ÷ 30		YMW	
HSS Spiral Pointed Dies			

M-MF

Special threads, gauges

INSPECTION TOOLS		DIN	
SIT		JIS	
		ANSI	
M-MF 2 ÷ 24		YMW	557
Simple Thread Inspection Tools			

INSPECTION TOOLS		DIN	
SITD		JIS	
		ANSI	
M-MF 2 ÷ 18		YMW	563
Simple Thread Inspection Tools, Tandem Type			

INSPECTION TOOLS		DIN	
CPC-S		JIS	
		ANSI	
M-MF 2 ÷ 12		YMW	569
Check Pins (Straight Type) for Bored Hole for Cutting Taps			

INSPECTION TOOLS		DIN	
CPR-S		JIS	
		ANSI	
M-MF 2 ÷ 12		YMW	581
Check Pins (Straight Type) for Bored Hole for Forming Taps			

LineUp arranged by type of thread

Intro

SP

Thread mills

THREAD MILLS		DIN	
PRML		JIS	
		ANSI	
M-MF 5 ÷ 12		Premium Thread Mills	YMW

SL

THREAD MILLS		DIN	
PRML TI		JIS	
		ANSI	
M-MF 8 ÷ 12		Premium Thread Mills	YMW

PO

ST

UNC

ROLL

SP - Spiral fluted taps

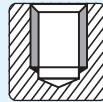

CARBIDE

Z-PRO		DIN	90
HVSP		JIS	
		ANSI	
UNC 1 ÷ 2		Spiral Fluted Taps for large forged parts in the heavy metalworking industry	YMW

LONG

GENERAL PURPOSE		DIN	97
SP		JIS	157
		ANSI	173
UNC No.1 ÷ 2		Spiral Fluted Taps	YMW

HAND TAPS

GENERAL PURPOSE		DIN	
SP LH		JIS	163
		ANSI	
UNC 1/4 ÷ 1/2		Spiral Fluted Taps for Left Hand Threads	YMW

EG (STI)

SPECIAL THREADS, GAUGES

MATERIAL SPECIFIC		DIN	134
SP-VA		JIS	
		ANSI	
UNC No.4 ÷ 1 1/2		Spiral Fluted Taps for Stainless Steel	YMW

THREAD MILLS

MATERIAL SPECIFIC		DIN	
SU+SP/SU-SP		JIS	167
		ANSI	
UNC No.2 ÷ 1		Spiral Fluted Taps for Stainless Steel	YMW

DIES

MATERIAL SPECIFIC		DIN	
ZELX SS SP		JIS	
		ANSI	176
UNC No.2 ÷ 2		Spiral Fluted Taps for Stainless Steel	YMW

CENTER DRILLS

MATERIAL SPECIFIC		DIN	
ZELX AL SP		JIS	
		ANSI	183
UNC No.2 ÷ 1/2		Spiral Fluted Taps for Aluminium	YMW

Technical info

MATERIAL SPECIFIC		DIN	143
ZEN-B		JIS	
		ANSI	
UNC No.4 ÷ 3/4		Spiral Fluted Taps for Nickel Base Alloys	YMW

MATERIAL SPECIFIC		DIN	
ZELX NI SP		JIS	
		ANSI	185
UNC No.2 ÷ 3/4		Spiral Fluted Taps for Nickel Base Alloys	YMW

MATERIAL SPECIFIC		DIN	145
ZET-B		JIS	
		ANSI	
UNC No.4 ÷ 3/4		Low Spiral Fluted Taps for Titanium Base Alloys	YMW

MATERIAL SPECIFIC		DIN	
ZELX TI SP		JIS	
		ANSI	188
UNC No.2 ÷ 1/2		Low Spiral Fluted Taps for Titanium Base Alloys	YMW

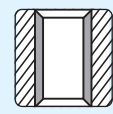
SL - Left spiral fluted taps		

MATERIAL SPECIFIC		DIN	
ZELX TI LHSP		JIS	
		ANSI	204
UNC No.2 ÷ 3/4		Left Spiral Fluted Taps for Titanium Base Alloys	YMW

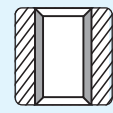
PO - Spiral pointed taps		

GENERAL PURPOSE		DIN	215
PO		JIS	238
		ANSI	248
UNC No.1 ÷ 1 1/2		Spiral Pointed Taps	YMW

GENERAL PURPOSE		DIN	
PO LH		JIS	241
		ANSI	
UNC 1/4 ÷ 1/2		Spiral Pointed Taps for Left Hand Threads	YMW

MATERIAL SPECIFIC		DIN	227
PO-VA		JIS	
		ANSI	
UNC No.4 ÷ 1		Spiral Pointed Taps for Stainless Steel	YMW

MATERIAL SPECIFIC		DIN	
SU+PO/SU-PO		JIS	244
		ANSI	
UNC No.2 ÷ 5/8		Spiral Pointed Taps for Stainless Steel	YMW

MATERIAL SPECIFIC		DIN	
ZELX SS PO		JIS	
		ANSI	251
UNC No.2 ÷ 2		Spiral Pointed Taps for Stainless Steel	YMW

MATERIAL SPECIFIC		DIN	
ZELX AL PO		JIS	
		ANSI	255
UNC No.2 ÷ 1/2		YMW	
Spiral Pointed Taps for Aluminium			

MATERIAL SPECIFIC		DIN	231
ZEN-P		JIS	
		ANSI	
UNC No.6 ÷ 3/4		YMW	
Spiral Pointed Taps for Nickel Base Alloys			

MATERIAL SPECIFIC		DIN	
ZELX NI PO		JIS	
		ANSI	257
UNC No.2 ÷ 3/4		YMW	
Spiral Pointed Taps for Nickel Base Alloys			

MULTI PURPOSE		DIN	
SURZ		JIS	383
		ANSI	
UNC No.2 ÷ No.6		YMW	
Thread Forming Taps for Stainless Steel, Coated			

MULTI PURPOSE		DIN	
SC-TL-RZ		JIS	385
		ANSI	
UNC No.2 ÷ No.4		YMW	
Torqueless Thread Forming Taps with short chamfer, Coated			

CT - Carbide taps

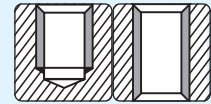

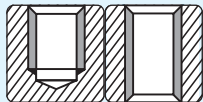
ST - Straight fluted taps			
			

MATERIAL SPECIFIC		DIN	
N-CT FC		JIS	405
		ANSI	
UNC No.4 ÷ 3/4		YMW	
Carbide Taps for Cast Iron			

GENERAL PURPOSE		DIN	271
HT		JIS	308
		ANSI	337
UNC No.1 ÷ 2		YMW	
Straight Fluted Taps			

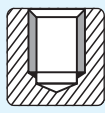
LONG - Long shank taps			
			

GENERAL PURPOSE		DIN	
HT LH		JIS	321
		ANSI	
UNC No.5 ÷ 1		YMW	
Straight Fluted Taps for Left Hand Threads			

GENERAL PURPOSE		DIN	
LS-SP		JIS	436
		ANSI	
UNC 1/4 ÷ 1		YMW	
Long Shank Spiral Fluted Taps			

MATERIAL SPECIFIC		DIN	
ZELX MOLD		JIS	
		ANSI	345
UNC No.4 ÷ 3/4		YMW	
Straight Fluted Taps for Hard Materials (<45HRC)			

GENERAL PURPOSE		DIN	
LS-PO		JIS	451
		ANSI	
UNC 1/4 ÷ 1		YMW	
Long Shank Spiral Pointed Taps			

MATERIAL SPECIFIC		DIN	
SU-HT		JIS	326
		ANSI	
UNC 1/4 ÷ 3/4		YMW	
Straight Fluted Taps for Stainless Steel			

GENERAL PURPOSE		DIN	
LS-HT		JIS	471
		ANSI	
UNC 1/4 ÷ 1		YMW	
Long Shank Straight Fluted Taps			

ROLL - Forming taps			
			

Dies			
-------------	--	--	--

GENERAL PURPOSE		DIN	
N+RZ/N-RZ		JIS	370
		ANSI	
UNC No.4 ÷ 1/2		YMW	
Thread Forming Taps for Steel			

DIES		DIN	596
DPO		JIS	
		ANSI	
UNC No.1 ÷ 1		YMW	
HSS Spiral Pointed Dies			

GENERAL PURPOSE		DIN	
N+RS/N-RS		JIS	377
		ANSI	
UNC No.2 ÷ 1/4		YMW	
Thread Forming Taps for Non-Ferrous Materials			

GENERAL PURPOSE		DIN	97
SP		JIS	157
		ANSI	173
UNF No.2 ÷ 1 1/2		YMW	
Spiral Fluted Taps			

MULTI PURPOSE		DIN	
HP+RZ/HP-RZ		JIS	380
		ANSI	389
UNC No.2 ÷ 1/2		YMW	
High Performance Thread Forming Taps, Coated			

GENERAL PURPOSE		DIN	
SP LH		JIS	163
		ANSI	
UNF 1/4 ÷ 1/2		YMW	
Spiral Fluted Taps for Left Hand Threads			

LineUp arranged by type of thread

Intro

SP

MATERIAL SPECIFIC	 <p>SP-VA</p> <p>Spiral Fluted Taps for Stainless Steel</p>	DIN	134
		JIS	
		ANSI	
UNF No.10 ÷ 1 1/2		YMW	

SL

MATERIAL SPECIFIC	 <p>SU+SP/SU-SP</p> <p>Spiral Fluted Taps for Stainless Steel</p>	DIN	
		JIS	167
		ANSI	
UNC No.4 ÷ 1		YMW	

PO

MATERIAL SPECIFIC	 <p>ZELX SS SP</p> <p>Spiral Fluted Taps for Stainless Steel</p>	DIN	
		JIS	
		ANSI	176
UNC No.4 ÷ 1 1/2		YMW	

ST

MATERIAL SPECIFIC	 <p>ZELX AL SP</p> <p>Spiral Fluted Taps for Aluminium</p>	DIN	
		JIS	
		ANSI	183
UNF No.10 ÷ 1/2		YMW	

ROLL

MATERIAL SPECIFIC	 <p>ZEN-B</p> <p>Spiral Fluted Taps for Nickel Base Alloys</p>	DIN	143
		JIS	
		ANSI	
UNF No.10 ÷ 3/4		YMW	

CARBIDE

MATERIAL SPECIFIC	 <p>ZELX NI SP</p> <p>Spiral Fluted Taps for Nickel Base Alloys</p>	DIN	
		JIS	
		ANSI	185
UNF No.10 ÷ 3/4		YMW	

LONG

MATERIAL SPECIFIC	 <p>ZET-B</p> <p>Low Spiral Fluted Taps for Titanium Base Alloys</p>	DIN	145
		JIS	
		ANSI	
UNF No.6 ÷ 1/2		YMW	

HAND TAPS

MATERIAL SPECIFIC	 <p>ZELX TI SP</p> <p>Low Spiral Fluted Taps for Titanium Base Alloys</p>	DIN	
		JIS	
		ANSI	188
UNF No.10 ÷ 1/2		YMW	

EG (STI)

SPECIAL THREADS, GAUGES

UNF

THREAD MILLS

SP - Spiral fluted taps

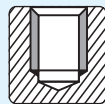

DIES

Z-PRO	 <p>HVSP</p> <p>Spiral Fluted Taps for large forged parts in the heavy metalworking industry</p>	DIN	90
		JIS	
		ANSI	
UNF 1 ÷ 1 1/2		YMW	

CENTER DRILLS

Technical info

SL - Left spiral fluted taps

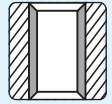

MATERIAL SPECIFIC	 <p>ZELX TI LHSP</p> <p>Left Spiral Fluted Taps for Titanium Base Alloys</p>	DIN	
		JIS	
		ANSI	204
UNF No.6 ÷ 3/4		YMW	

PO - Spiral pointed taps

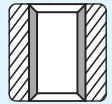

GENERAL PURPOSE	 <p>PO</p> <p>Spiral Pointed Taps</p>	DIN	215
		JIS	238
		ANSI	248
UNF No.0 ÷ 1 1/2		YMW	

GENERAL PURPOSE	 <p>PO LH</p> <p>Spiral Pointed Taps for Left Hand Threads</p>	DIN	
		JIS	241
		ANSI	
UNF 1/4 ÷ 1/2		YMW	

MATERIAL SPECIFIC	 <p>PO-VA</p> <p>Spiral Pointed Taps for Stainless Steel</p>	DIN	228
		JIS	
		ANSI	
UNF No.10 ÷ 1		YMW	

MATERIAL SPECIFIC	 <p>SU+PO/SU-PO</p> <p>Spiral Pointed Taps for Stainless Steel</p>	DIN	
		JIS	245
		ANSI	
UNF No.4 ÷ 9/16		YMW	

MATERIAL SPECIFIC	 <p>ZELX SS PO</p> <p>Spiral Pointed Taps for Stainless Steel</p>	DIN	
		JIS	
		ANSI	252
UNC No.4 ÷ 1 1/2		YMW	

MATERIAL SPECIFIC	 <p>ZELX AL PO</p> <p>Spiral Pointed Taps for Aluminium</p>	DIN	
		JIS	
		ANSI	255
UNF No.10 ÷ 1/2		YMW	

MATERIAL SPECIFIC	 <p>ZEN-P</p> <p>Spiral Pointed Taps for Nickel Base Alloys</p>	DIN	231
		JIS	
		ANSI	
UNF No.10 ÷ 3/4		YMW	

MATERIAL SPECIFIC	 <p>ZELX NI PO</p> <p>Spiral Pointed Taps for Nickel Base Alloys</p>	DIN	
		JIS	
		ANSI	257
UNF No.6 ÷ 3/4		YMW	

ST - Straight fluted taps

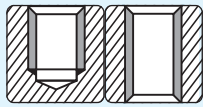

GENERAL PURPOSE	 YAMAWA Straight Fluted Taps	DIN	271
HT		JIS	308
		ANSI	337
UNF No.0 ÷ 1 1/2		YMW	

GENERAL PURPOSE	 YAMAWA Straight Fluted Taps for Left Hand Threads	DIN	
HT LH		JIS	321
		ANSI	
UNC No.12 ÷ 1		YMW	

MATERIAL SPECIFIC	 YAMAWA Straight Fluted Taps for Hard Materials (<45HRC)	DIN	
ZELX MOLD		JIS	
		ANSI	345
UNC No.10 ÷ 3/4		YMW	

MATERIAL SPECIFIC	 YAMAWA Straight Fluted Taps for Stainless Steel	DIN	
SU-HT		JIS	327
		ANSI	
UNF 1/4 ÷ 3/4		YMW	

ROLL - Forming taps

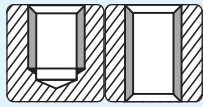



GENERAL PURPOSE	 YAMAWA Thread Forming Taps for Steel	DIN	
N+RZ/N-RZ		JIS	371
		ANSI	
UNF 3/8 ÷ 1/2		YMW	

GENERAL PURPOSE	 YAMAWA Thread Forming Taps for Non-Ferrous Materials	DIN	
N+RS/N-RS		JIS	377
		ANSI	
UNF No.0 ÷ 1/4		YMW	

MULTI PURPOSE	 YAMAWA High Performance Thread Forming Taps, Coated	DIN	
HP+RZ/HP-RZ		JIS	381
		ANSI	389
UNF No.2 ÷ 1/2		YMW	

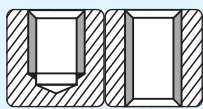
CT - Carbide taps



MATERIAL SPECIFIC	 YAMAWA Carbide Taps for Cast Iron	DIN	
N-CT FC		JIS	406
		ANSI	
UNF No.4 ÷ 3/4		YMW	

LONG - Long shank taps

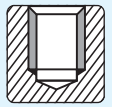

GENERAL PURPOSE	 YAMAWA Long Shank Spiral Fluted Taps	DIN	
LS-SP		JIS	436
		ANSI	
UNF 1/4 ÷ 1		YMW	

GENERAL PURPOSE	 YAMAWA Long Shank Spiral Pointed Taps	DIN	
LS-PO		JIS	452
		ANSI	
UNF 1/4 ÷ 1		YMW	

GENERAL PURPOSE	 YAMAWA Long Shank Straight Fluted Taps	DIN	
LS-HT		JIS	472
		ANSI	
UNF 1/4 ÷ 1		YMW	

Dies

DIES		DIN	597
DPO		JIS	
		ANSI	
UNF No.0 ÷ 1		YMW	

UNC-UNF

Special threads, gauges

INSPECTION TOOLS	 YAMAWA Simple Thread Inspection Tools	DIN	
SIT		JIS	
		ANSI	
UNC-UNF No.2 ÷ 5/8		YMW	560

INSPECTION TOOLS	 YAMAWA Simple Thread Inspection Tools, Tandem Type	DIN	
SITD		JIS	
		ANSI	
UNC-UNF No.2 ÷ 5/8		YMW	564

INSPECTION TOOLS	 YAMAWA Check Pins (Straight Type) for Bored Hole for Cutting Taps	DIN	
CPC-S		JIS	
		ANSI	
UNC-UNF No.2 ÷ 1/2		YMW	574

INSPECTION TOOLS	 YAMAWA Check Pins (Straight Type) for Bored Hole for Forming Taps	DIN	
CPR-S		JIS	
		ANSI	
UNC-UNF No.2 ÷ 1/2		YMW	581

LineUp arranged by type of thread

Intro

SP

Thread mills

THREAD MILLS		DIN	
PRML		JIS	
		ANSI	
UNC-UNF No.10 ÷ 1/2		Premium Thread Mills	YMW

SL

THREAD MILLS		DIN	
PRML TI		JIS	
		ANSI	
UNC-UNF 5/16 ÷ 1/2		Premium Thread Mills	YMW

PO

ST

UNS

ROLL

SP - Spiral fluted taps

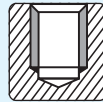

CARBIDE

GENERAL PURPOSE		DIN	
SP		JIS	158
		ANSI	
UNS 1 ÷ 1 1/8		Spiral Fluted Taps	YMW

LONG

PO - Spiral pointed taps

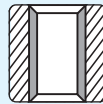

HAND TAPS

GENERAL PURPOSE		DIN	
PO		JIS	238
		ANSI	
UNS 1		Spiral Pointed Taps	YMW

EG (STI)

SPECIAL THREADS, GAUGES

ST - Straight fluted taps

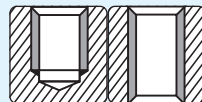

THREAD MILLS

GENERAL PURPOSE		DIN	
HT		JIS	310
		ANSI	
UNS 7/16 ÷ 1 5/8		Straight Fluted Taps	YMW

DIES

CENTER DRILLS

Technical info

8UN

SP - Spiral fluted taps

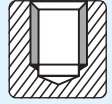

Z-PRO		DIN	90
HVSP		JIS	
		ANSI	
8UN 1 1/8 ÷ 2		Spiral Fluted Taps for large forged parts in the heavy metalworking industry	YMW

GENERAL PURPOSE		DIN	
SP		JIS	159
		ANSI	
8UN 1 1/8 ÷ 1 1/2		Spiral Fluted Taps	YMW

MATERIAL SPECIFIC		DIN	135
SP-VA		JIS	
		ANSI	
8UN 1 1/8 ÷ 2		Spiral Fluted Taps for Stainless Steel	YMW

ST - Straight fluted taps

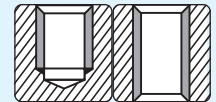

GENERAL PURPOSE		DIN	
HT		JIS	310
		ANSI	
8UN 1 1/8 ÷ 3		Straight Fluted Taps	YMW

12UN

SP - Spiral fluted taps

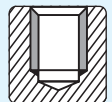

Z-PRO		DIN	90
HVSP		JIS	
		ANSI	
12UN 1 3/4		Spiral Fluted Taps for large forged parts in the heavy metalworking industry	YMW

GENERAL PURPOSE		DIN	
SP		JIS	159
		ANSI	
12UN 1 3/4 ÷ 2		Spiral Fluted Taps	YMW

ST - Straight fluted taps

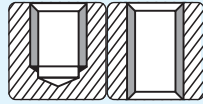

GENERAL PURPOSE		DIN	
HT		JIS	311
		ANSI	
12UN 1 1/16 ÷ 2		YMW	

Straight Fluted Taps

20UN

ST - Straight fluted taps

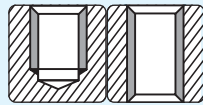

GENERAL PURPOSE		DIN	
HT		JIS	311
		ANSI	
20UN 9/16 ÷ 5/8		YMW	

Straight Fluted Taps

32UN

ST - Straight fluted taps

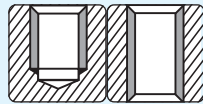

GENERAL PURPOSE		DIN	
HT		JIS	311
		ANSI	
32UN 1/2		YMW	

Straight Fluted Taps

UNEF

SP - Spiral fluted taps

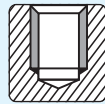

GENERAL PURPOSE		DIN	
SP		JIS	159
		ANSI	
UNEF 1/4 ÷ 1		YMW	

Spiral Fluted Taps

PO - Spiral pointed taps

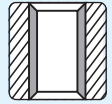

GENERAL PURPOSE		DIN	
PO		JIS	238
		ANSI	
UNEF 1/4 ÷ 3/4		YMW	

Spiral Pointed Taps

ST - Straight fluted taps

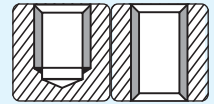

GENERAL PURPOSE		DIN	
HT		JIS	311
		ANSI	
UNEF No.12 ÷ 1		YMW	

Straight Fluted Taps

G(BSP)

SP - Spiral fluted taps

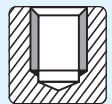

Z-PRO		DIN	84
AUSP G		JIS	
		ANSI	
G 1/8 ÷ 1		YMW	

Spiral Fluted Taps for Parallel Pipe Threads, Coated

GENERAL PURPOSE		DIN	98
SP		JIS	
		ANSI	
G 1/16 ÷ 1 1/2		YMW	

Spiral Fluted Taps

GENERAL PURPOSE		DIN	110
SP OX		JIS	
		ANSI	
G 1/8 ÷ 1 1/2		YMW	

Spiral Fluted Taps, Oxided

GENERAL PURPOSE		DIN	115
SP V		JIS	
		ANSI	
G 1/8 ÷ 1/2		YMW	

Spiral Fluted Taps, Coated

GENERAL PURPOSE		DIN	117
LO-SP		JIS	
		ANSI	
G 1/8 ÷ 1/2		YMW	

Low Spiral Fluted Taps

GENERAL PURPOSE		DIN	119
LO-SP OX		JIS	
		ANSI	
G 1/8 ÷ 1		YMW	

Low Spiral Fluted Taps, Oxided

SP

SL

PO

ST

ROLL

CARBIDE

LONG

HAND TAPS

EG (STI)

SPECIAL THREADS, GAUGES

THREAD MILLS

DIES

CENTER DRILLS

Technical info

LineUp arranged by type of thread

Intro

SP

MATERIAL SPECIFIC		DIN	125
PH-SP		JIS	
G 1/8 ÷ 1/2	Spiral Fluted Taps for Hard Materials (<35HRC)	ANSI	
		YMW	

SL

MATERIAL SPECIFIC		DIN	135
SP-VA		JIS	
G 1/8 ÷ 1	Spiral Fluted Taps for Stainless Steel	ANSI	
		YMW	

PO

MATERIAL SPECIFIC		DIN	139
SU2-SP		JIS	
G 1/8 ÷ 3/4	Spiral Fluted Taps for Tough Stainless Steel	ANSI	
		YMW	

ST

PO - Spiral pointed taps

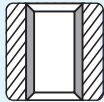

ROLL

GENERAL PURPOSE		DIN	216
PO		JIS	
G 1/16 ÷ 1 1/2	Spiral Pointed Taps	ANSI	
		YMW	

CARBIDE

GENERAL PURPOSE		DIN	219
PO OX		JIS	
G 1/8 ÷ 1	Spiral Pointed Taps, Oxided	ANSI	
		YMW	

LONG

GENERAL PURPOSE		DIN	221
PO V		JIS	
G 1/8 ÷ 1/2	Spiral Pointed Taps, Coated	ANSI	
		YMW	

HAND TAPS

MATERIAL SPECIFIC		DIN	228
PO-VA		JIS	
G 1/8 ÷ 1	Spiral Pointed Taps for Stainless Steel	ANSI	
		YMW	

EG (STI)

ST - Straight fluted taps

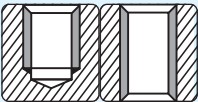

SPECIAL THREADS, GAUGES

THREAD MILLS

Z-PRO		DIN	265
GGST		JIS	
G 1/8 ÷ 1	Straight Fluted Taps for Cast Iron, Coated	ANSI	
		YMW	

DIES

GENERAL PURPOSE		DIN	272
HT		JIS	
G 1/16 ÷ 1 1/2	Straight Fluted Taps	ANSI	
		YMW	

CENTER DRILLS

GENERAL PURPOSE		DIN	
PF LH		JIS	323
G 1/8 ÷ 2	Straight Fluted Taps for Parallel Pipe Threads, for Left Hand Threads	ANSI	
		YMW	

Technical info

MATERIAL SPECIFIC		DIN	275
EH-HT		JIS	
G 1/8 ÷ 1/2	Straight Fluted Taps for Hard Materials (<45HRC)	ANSI	
		YMW	

MATERIAL SPECIFIC		DIN	279
GG-HT		JIS	
G 1/8 ÷ 1	Straight Fluted Taps for Cast Iron	ANSI	
		YMW	

MATERIAL SPECIFIC		DIN	281
GG-HT TiCN		JIS	
G 1/8 ÷ 1/2	Straight Fluted Taps for Cast Iron, Coated	ANSI	
		YMW	

ROLL - Forming taps

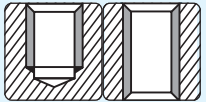



GENERAL PURPOSE		DIN	353
R-D		JIS	
G 1/8 ÷ 3/8	Thread Forming Taps for Low Hardness Materials	ANSI	
		YMW	

GENERAL PURPOSE		DIN	355
R-D V		JIS	
G 1/8 ÷ 3/8	Thread Forming Taps for Low Hardness Materials, Coated	ANSI	
		YMW	

MATERIAL SPECIFIC		DIN	
CT-PF		JIS	407
G 1/8 ÷ 1	Carbide Taps for Parallel Pipe Threads, for Cast Iron and Non-Ferrous Materials	ANSI	
		YMW	

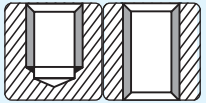
CT - Carbide taps



MATERIAL SPECIFIC		DIN	395
CT FC		JIS	
G 3/8	Carbide Taps for Cast Iron	ANSI	
		YMW	

LONG - Long shank taps



GENERAL PURPOSE		DIN	
LS-SP-PF		JIS	438
G 1/8 ÷ 1	Long Shank Spiral Fluted Taps for Parallel Pipe Threads	ANSI	
		YMW	

GENERAL PURPOSE		DIN	
LS-PF		JIS	474
G 1/8 ÷ 2	Long Shank Straight Fluted Taps for Parallel Pipe Threads	ANSI	
		YMW	

HAND TAPS - Taps for hand and drilling machine application

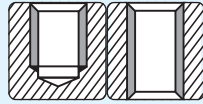

HAND TAPS	<p>Serial taps for manual use</p>	DIN	502
6412		JIS	
G 1/8 ÷ 1		ANSI	
		YMW	

HAND TAPS	<p>Straight Fluted Taps for manual and drilling machine use</p>	DIN	503
HT DIN5157		JIS	
G 1/8 ÷ 1		ANSI	
		YMW	

Dies

DIES	<p>HSS Spiral Pointed Dies</p>	DIN	597
DPO		JIS	
G 1/8 ÷ 1 1/2		ANSI	
		YMW	

Rp(BSPP)

SP - Spiral fluted taps

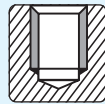

Z-PRO	<p>Spiral Fluted Taps for Parallel Pipe Threads, Coated</p>	DIN	85
AUSP Rp		JIS	
Rp 1/8 ÷ 1		ANSI	
		YMW	

LONG - Long shank taps

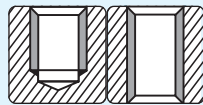

GENERAL PURPOSE	<p>Long Shank Straight Fluted Taps for Parallel Pipe Threads</p>	DIN	
LS-PS		JIS	475
Rp 1/8 ÷ 1 1/2		ANSI	
		YMW	

Rc(BSPT)

SP - Spiral fluted taps



Z-PRO	<p>Spiral Fluted Taps for Taper Pipe Threads, Coated</p>	DIN	87
AUSP Rc		JIS	
Rc 1/16 ÷ 1		ANSI	
		YMW	

MATERIAL SPECIFIC	<p>Spiral Fluted Taps for Hard Materials (<45HRC)</p>	DIN	129
PMSP		JIS	
Rc 1/8 ÷ 1		ANSI	
		YMW	

ST - Straight fluted taps

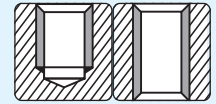

MATERIAL SPECIFIC	<p>Straight Fluted Taps for Hard Materials (<45HRC)</p>	DIN	277
PMST		JIS	
Rc 1/8 ÷ 1		ANSI	
		YMW	

LONG - Long shank taps

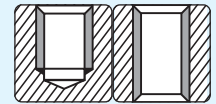

GENERAL PURPOSE	<p>Long Shank Straight Fluted Taps for Taper Pipe Threads</p>	DIN	
LS-PT		JIS	477
Rp 1/16 ÷ 2		ANSI	
		YMW	

NPT

SP - Spiral fluted taps

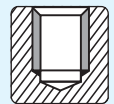

MATERIAL SPECIFIC	<p>Taps for American Taper Pipe Threads, for stainless steel</p>	DIN	
ZELX SS NPT		JIS	
NPT 1/16 ÷ 1		ANSI	180
		YMW	

SP

SL

PO

ST

ROLL

CARBIDE

LONG

HAND TAPS

EG (STI)

SPECIAL THREADS, GAUGES

THREAD MILLS

DIES

CENTER DRILLS

Technical info

LineUp arranged by type of thread

Intro

SP

ST - Straight fluted taps

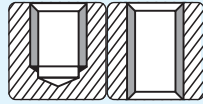

LONG - Long shank taps

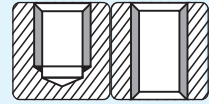

SL

GENERAL PURPOSE		DIN	
NPT	 Straight Fluted Taps for American Taper Pipe Threads	JIS	
NPT 1/16 ÷ 2		ANSI	340
		YMW	

GENERAL PURPOSE		DIN	
LS-NPTF	 Long Shank Straight Fluted Taps for American Dryseal Taper Pipe Threads	JIS	479
NPTF 1/16 ÷ 1		ANSI	
		YMW	

PO

MATERIAL SPECIFIC		DIN	
ZELX MOLD NPT	 Straight Fluted Taps for American Taper Pipe Threads, for Hard Materials (<45HRC)	JIS	
NPT 1/8 ÷ 3/4		ANSI	346
		YMW	

NPS

ST

LONG - Long shank taps

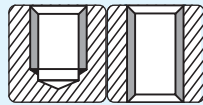

ST - Straight fluted taps

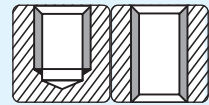

ROLL

GENERAL PURPOSE		DIN	
LS-NPT	 Long Shank Straight Fluted Taps for American Taper Pipe Threads	JIS	478
NPT 1/16 ÷ 1		ANSI	
		YMW	

GENERAL PURPOSE		DIN	
NPS	 Straight Fluted Taps for American Parallel Pipe Threads	JIS	
NPS 1/8 ÷ 1		ANSI	342
		YMW	

CARBIDE

Dies

NPSF

LONG

DIES		DIN	
DPO	 HSS Spiral Pointed Dies	JIS	597
NPT 1/8 ÷ 1		ANSI	
		YMW	

ST - Straight fluted taps

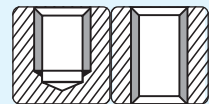

HAND TAPS

EG (STI)

NPTF

GENERAL PURPOSE		DIN	
NPSF	 Straight Fluted Taps for American Dryseal Parallel Pipe Threads	JIS	
NPSF 1/8 ÷ 1		ANSI	343
		YMW	

SPECIAL THREADS, GAUGES

SP - Spiral fluted taps

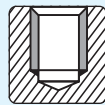

BSW

THREAD MILLS

MATERIAL SPECIFIC		DIN	
ZELX SS NPTF	 Taps for American Dryseal Taper Pipe Threads, for stainless steel	JIS	
NPTF 1/16 ÷ 1		ANSI	181
		YMW	

SP - Spiral fluted taps

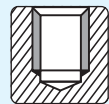

DIES

ST - Straight fluted taps

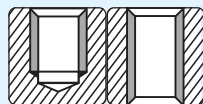

GENERAL PURPOSE		DIN	
SP	 Spiral Fluted Taps	JIS	159
BSW 1/8 ÷ 2		ANSI	
		YMW	

CENTER DRILLS

GENERAL PURPOSE		DIN	
NPTF	 Straight Fluted Taps for American Dryseal Taper Pipe Threads	JIS	
NPTF 1/16 ÷ 2		ANSI	341
		YMW	

GENERAL PURPOSE		DIN	
SP LH	 Spiral Fluted Taps for Left Hand Threads	JIS	163
BSW 1/4 ÷ 3/4		ANSI	
		YMW	

Technical info

MATERIAL SPECIFIC	 Spiral Fluted Taps for Stainless Steel	DIN	
SU+SP/SU-SP		JIS	167
		ANSI	
BSW 3/16 ÷ 1		YMW	

GENERAL PURPOSE	 Long Shank Straight Fluted Taps	DIN	
LS-HT		JIS	473
		ANSI	
BSW 1/4 ÷ 1		YMW	

PO - Spiral pointed taps

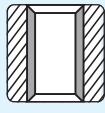

Special threads, gauges

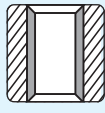

GENERAL PURPOSE	 Spiral Pointed Taps	DIN	
PO		JIS	239
		ANSI	
BSW 1/8 ÷ 2		YMW	

GENERAL PURPOSE	 Nut Taps	DIN	
NT		JIS	540
		ANSI	
BSW 1/8 ÷ 1 1/2		YMW	

GENERAL PURPOSE	 Spiral Pointed Taps for Left Hand Threads	DIN	
PO LH		JIS	241
		ANSI	
BSW 1/4 ÷ 3/4		YMW	

EG(STI) M

MATERIAL SPECIFIC	 Spiral Pointed Taps for Stainless Steel	DIN	
SU+PO/SU-PO		JIS	245
		ANSI	
BSW 3/16 ÷ 1		YMW	

EG(STI)

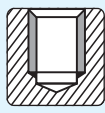

ST - Straight fluted taps

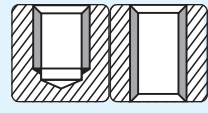

MATERIAL SPECIFIC	 Spiral Fluted Taps for Helical Coil Wire Screw Thread Inserts on Aluminium Alloys	DIN	
AL-SP STI		JIS	511
		ANSI	
EG M 3 ÷ 24		YMW	

GENERAL PURPOSE	 Straight Fluted Taps	DIN	
HT		JIS	312
		ANSI	
BSW 1/16 ÷ 4		YMW	

MATERIAL SPECIFIC	 Spiral Pointed Taps for Helical Coil Wire Screw Thread Inserts on Aluminium Alloys	DIN	
AL-PO STI		JIS	513
		ANSI	
EG M 3 ÷ 12		YMW	

GENERAL PURPOSE	 Straight Fluted Taps for Left Hand Threads	DIN	
HT LH		JIS	322
		ANSI	
BSW 1/8 ÷ 1 1/8		YMW	

MATERIAL SPECIFIC	 Straight Fluted Taps for Helical Coil Wire Screw Thread Inserts on Aluminium Alloys	DIN	
AL-HT STI		JIS	515
		ANSI	
EG M 2.6 ÷ 24		YMW	

MATERIAL SPECIFIC	 Straight Fluted Taps for Stainless Steel	DIN	
SU-HT		JIS	327
		ANSI	
BSW 1/4 ÷ 3/4		YMW	

GENERAL PURPOSE	 Thread Forming Taps for Helical Coil Wire Screw Thread Inserts	DIN	
N-RS STI		JIS	519
		ANSI	
EG M 3 ÷ 12		YMW	

LONG - Long shank taps

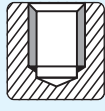

EG(STI) MF

GENERAL PURPOSE	 Long Shank Spiral Fluted Taps	DIN	
LS-SP		JIS	436
		ANSI	
BSW 1/4 ÷ 1		YMW	

EG(STI)



GENERAL PURPOSE	 Long Shank Spiral Pointed Taps	DIN	
LS-PO		JIS	452
		ANSI	
BSW 1/4 ÷ 1		YMW	

MATERIAL SPECIFIC	 Spiral Fluted Taps for Helical Coil Wire Screw Thread Inserts on Aluminium Alloys	DIN	
AL-SP STI		JIS	511
		ANSI	
EG MF 10 ÷ 20		YMW	

Technical info

LineUp arranged by type of thread

Intro

MATERIAL SPECIFIC	 <p>Straight Fluted Taps for Helical Coil Wire Screw Thread Inserts on Aluminium Alloys</p>	DIN	
AL-HT STI		JIS	515
EG MF 10 ÷ 24		ANSI	
		YMW	

SP

GENERAL PURPOSE	 <p>Thread Forming Taps for Helical Coil Wire Screw Thread Inserts</p>	DIN	
N-RS STI		JIS	519
		ANSI	
EG MF 10 ÷ 12		YMW	

SL

EG(STI) UNC			
--------------------	--	--	--

PO

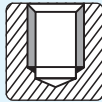
EG(STI)		

ST

GENERAL PURPOSE	 <p>Spiral Fluted Taps for Helical Coil Wire Screw Thread Inserts</p>	DIN	
SP STI		JIS	
		ANSI	521
EG UNC No.2 ÷ 1/2		YMW	

ROLL

MATERIAL SPECIFIC	 <p>Spiral Fluted Taps for Nickel Base Alloys, for Helical Coil Wire Screw Thread Inserts</p>	DIN	
ZELX NI SP STI		JIS	
		ANSI	522
EG UNC No.2 ÷ 1/2		YMW	

CARBIDE

GENERAL PURPOSE	 <p>Spiral Pointed Taps for Helical Coil Wire Screw Thread Inserts</p>	DIN	
PO STI		JIS	
		ANSI	525
EG UNC No.2 ÷ 1/2		YMW	

LONG

MATERIAL SPECIFIC	 <p>Spiral Pointed Taps for Nickel Base Alloys for Helical Coil Wire Screw Thread Inserts</p>	DIN	
ZELX NI PO STI		JIS	
		ANSI	527
EG UNC No.2 ÷ 1/2		YMW	

HAND TAPS

MATERIAL SPECIFIC	 <p>Straight Fluted Taps for Helical Coil Wire Screw Thread Inserts on Aluminium Alloys</p>	DIN	
AL-HT STI		JIS	516
		ANSI	
EG UNC No.4 ÷ 3/4		YMW	

SPECIAL THREADS, GAUGES

GENERAL PURPOSE	 <p>Straight Fluted Taps for Helical Coil Wire Screw Thread Inserts</p>	DIN	
HT STI		JIS	
		ANSI	529
EG UNC No.2 ÷ 1/2		YMW	

THREAD MILLS

GENERAL PURPOSE	 <p>Straight Fluted Taps for Pg Threads</p>	DIN	536
HT Pg		JIS	
		ANSI	
Pg 7 ÷ 36		YMW	

DIES

Special threads, gauges			
			

CENTER DRILLS

Technical info

EG(STI) UNF			
--------------------	--	--	--

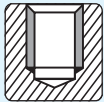
EG(STI)		

GENERAL PURPOSE	 <p>Spiral Fluted Taps for Helical Coil Wire Screw Thread Inserts</p>	DIN	
SP STI		JIS	
		ANSI	521
EG UNF No.10 ÷ 1/2		YMW	

MATERIAL SPECIFIC	 <p>Spiral Fluted Taps for Nickel Base Alloys, for Helical Coil Wire Screw Thread Inserts</p>	DIN	
ZELX NI SP STI		JIS	
		ANSI	523
EG UNF No.6 ÷ 1/2		YMW	

GENERAL PURPOSE	 <p>Spiral Pointed Taps for Helical Coil Wire Screw Thread Inserts</p>	DIN	
PO STI		JIS	
		ANSI	525
EG UNF No.10 ÷ 1/2		YMW	

MATERIAL SPECIFIC	 <p>Spiral Pointed Taps for Nickel Base Alloys for Helical Coil Wire Screw Thread Inserts</p>	DIN	
ZELX NI PO STI		JIS	
		ANSI	527
EG UNF No.6 ÷ 1/2		YMW	

MATERIAL SPECIFIC	 <p>Straight Fluted Taps for Helical Coil Wire Screw Thread Inserts on Aluminium Alloys</p>	DIN	
AL-HT STI		JIS	517
		ANSI	
EG UNF No.4 ÷ 3/4		YMW	

GENERAL PURPOSE	 <p>Straight Fluted Taps for Helical Coil Wire Screw Thread Inserts</p>	DIN	
HT STI		JIS	
		ANSI	529
EG UNF No.10 ÷ 1/2		YMW	

Pg			
-----------	--	--	--

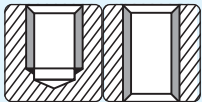
Special threads, gauges			
--------------------------------	--	---	--

GENERAL PURPOSE	 <p>Straight Fluted Taps for Pg Threads</p>	DIN	536
HT Pg		JIS	
		ANSI	
Pg 7 ÷ 36		YMW	

Tr

Special threads, gauges

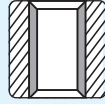



GENERAL PURPOSE		DIN	
SL Tr		JIS	544
Tr 10 ÷ 30	Left Spiral Fluted Taps for Trapezoidal Threads	ANSI	
		YMW	

GENERAL PURPOSE		DIN	
SL LH Tr		JIS	545
Tr 10 ÷ 30	Left Spiral Fluted Taps for Trapezoidal Left Hand Threads	ANSI	
		YMW	

S Miniature

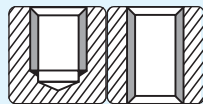
Special threads, gauges



GENERAL PURPOSE		DIN	
MS+TR		JIS	541
S 0.4 ÷ 0.9	Straight Fluted Taps for Miniature Threads	ANSI	
		YMW	

GENERAL PURPOSE		DIN	
MS+RS		JIS	542
S 0.6 ÷ 0.9	Roll Taps for Miniature Threads	ANSI	
		YMW	

MULTI PURPOSE		DIN	
HPsRZ		JIS	543
S 0.6 ÷ 0.9	High Performance Roll Taps for Miniature Threads, Coated	ANSI	
		YMW	

TRI

Special threads, gauges

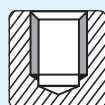



GENERAL PURPOSE		DIN	
SP TRI		JIS	546
TRI 1/4	Spiral Fluted Taps for Tripod Threads	ANSI	
		YMW	

GENERAL PURPOSE		DIN	
HT TRI		JIS	547
TRI 1/4	Straight Fluted Taps for Tripod Threads	ANSI	
		YMW	

RLS

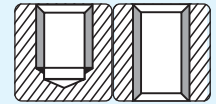
Special threads, gauges



GENERAL PURPOSE		DIN	
RLS-HT		JIS	548
RLS 3.4	Straight Fluted Taps for Camera Release Threads	ANSI	
		YMW	

V

Special threads, gauges

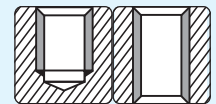

GENERAL PURPOSE		DIN	
HT TV		JIS	549
TV 5V1 ÷ 13V2	Straight fluted Taps for Automobile Tire Valve Threads	ANSI	
		YMW	

CTV

Special threads, gauges

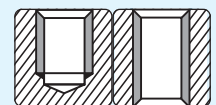

GENERAL PURPOSE		DIN	
HT CTV		JIS	551
CTV 5 ÷ 8	Straight fluted Taps for Bicycle Tire Valve Threads	ANSI	
		YMW	

SP

SL

PO

ST

ROLL

CARBIDE

LONG

HAND TAPS

EG (STI)

SPECIAL THREADS, GAUGES

THREAD MILLS

DIES

CENTER DRILLS

Technical info

LineUp arranged by type of thread

Intro

SP **BC**

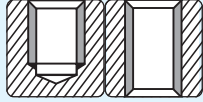
SL Special threads, gauges 

PO	GENERAL PURPOSE	 Straight Fluted Taps for Bicycle Threads	DIN	
	HT BC		JIS	553
	BC 5/16 ÷ 1 9/16		ANSI	
			YMW	

ST **CTC**

ROLL Special threads, gauges

CARBIDE	GENERAL PURPOSE	 Straight Fluted Taps for Metal Thin-Walled Conduit Threads	DIN	
	HT CTC		JIS	554
	CTC 19 ÷ 39		ANSI	
			YMW	

LONG **CTG**

HAND TAPS Special threads, gauges

EG (STI)	GENERAL PURPOSE	 Straight Fluted Taps for Metal Thick-Walled Conduit Threads	DIN	
	HT CTG		JIS	555
	CTC 16 ÷ 42		ANSI	
			YMW	

SPECIAL THREADS, GAUGES

THREAD MILLS

DIES

CENTER DRILLS

Technical info

Intro
SP
SL
PO
ST
ROLL
CARBIDE
LONG
HAND TAPS
EG (STI)
SPECIAL THREADS, GAUGES
THREAD MILLS
DIES
CENTER DRILLS
Technical info

Icons

Legend Verzeichnis Légende Leyenda Название

Intro

SP

HSS

- High speed steel
- Acciaio super rapido
- Schnellarbeitsstahl HSS
- Acier super rapide
- Acero super rápido
- Быстрорежущая сталь

HSS-E

- Class E high speed steel
- Acciaio super rapido di classe E
- Schnellarbeitsstahl HSS Klasse E
- Acier super rapide de catégorie E
- Acero super rápido de clase E
- Быстрорежущая сталь с ванадием

SL

HSS-Co

- High speed steel (Cobalt HSS)
- Acciaio super rapido al cobalto
- Legierter Kobalt Schnellarbeitsstahl HSS
- Acier super rapide au cobalt
- Acero super rápido (aleación de cobalto)
- Быстрорежущая сталь с кобальтом

HSS-P

- Powder HSS
- Acciaio super rapido sinterizzato
- Gesinterter Schnellarbeitsstahl HSS
- Acier super rapide fritté
- Acero super rápido sinterizado
- Порошковая быстрорежущая сталь

PO

HF CARBIDE

- Ultra micro grain cemented carbide
- Metallo duro micrograna ultra fine
- Feinstkornhartmetall
- Carbure ultramicrograin
- Metal duro micragrana ultra fina
- Ультра-мелкозернистый твердый сплав

COATING

- Coated
- Rivestito
- Beschichtet
- Revêtu
- Recubierto
- С покрытием

ST

OX

- Oxidizing
- Vaporizzazione
- Vaporisieren (Dampfangelassen)
- Traitement vapeur
- Vaporizado
- Оксидирование

NI

- Nitriding
- Nitrurazione
- Nitrieren
- Nitruéré
- Nitruizado
- Азотирование

ROLL

NX

- Nitriding/Oxidizing
- Nitrurazione/Vaporizzazione
- Nitrieren/Vaporisieren
- Nitruéré/Traitement vapeur
- Nitruizado/Vaporizado
- Азотирование/оксидирование

- Central coolant hole
- Foro di refrigerazione centrale
- Interner Kühlung
- Arrosage par le centre
- Canal de refrigeración central
- Центральное отверстие для СОЖ

CARBIDE

- Radial coolant hole
- Fori di refrigerazione radiali
- Radialer Kühlung
- Arrosage radial
- Canales de refrigeración radiales
- Радиальные отверстия для СОЖ

SYNCHRO

- Synchronized
- Per maschiatura sincronizzata
- Für synchronisierte Gewindebohrung
- Pour taraudage synchronisé
- Sincronizado
- Синхронизация

LONG

LH LEFT HAND

- For left-hand thread
- Per filettatura sinistra
- Für Linksgewinde
- Pour taraudage pas à gauche
- Para roscado izquierdo
- Для левой резьбы

V-F-M SET

- V-M-F chamfer for DIN hand set
- Imbocco V-M-F per serie a mano
- V-M-F Anschnitt für DIN Handgewindebohrer Sets
- Entrée V-M-F taraud main
- Entrada V-M-F para serie a mano DIN
- Заходные части V-M-F по DIN для набора метчиков

HAND TAPS

...P THCHT

- Chamfer length (no. of pitches)
- Numero di filetti di imbocco
- Ansnittlänge (Anzahl Gänge)
- Nombre de filet d'entrée
- Longitud entrada (no. Pasos)
- Длина заходной части (кол. шагов)

ISO... (6...) TCTR

- Tap tolerance
- Tolleranza del maschio
- Gewindebohrer Toleranz
- Tolérance de taraud
- Tolerancia del macho
- Допуск метчика

EG (STI)

- Blind hole
- Foro cieco
- Sackloch
- Trou borgne
- Agujero ciego
- Глухое отверстие

- Through hole
- Foro passante
- Durchgangsloch
- Trou débouchant
- Agujero pasante
- Сквозное отверстие

SPECIAL THREADS, GAUGES

THREAD MILLS

DIES

CENTER DRILLS

























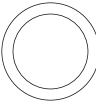



Technical info















	<ul style="list-style-type: none">  Spiral fluted tap blind hole  Maschio elicoidale per fori ciechi  Spiralgenuteter Gewindebohrer für Sacklöcher  Taraud hélicoïdal pour trou borgne  Macho helicoidal para agujeros ciegos  Спиральный метчик для глухого отверстия
	<ul style="list-style-type: none">  Left spiral fluted tap through hole  Maschio con elica sinistra per fori passanti  Gewindebohrer mit linksgedrahter Spiralnut für Durchgangslöcher  Taraud à hélice gauche pour trou débouchant  Macho con hélice izquierda para agujeros pasantes  Метчик с левой спиралью для сквозного отверстия
	<ul style="list-style-type: none">  Straight fluted taps for blind hole  Maschio a tagliente dritto per fori ciechi  Geradegenuteter Gewindebohrer für Sacklöcher  Taraud à goujures droites pour trou borgne  Macho con ranuras rectas para agujero ciego  Метчик с прямыми канавками для глухого отверстия
	<ul style="list-style-type: none">  Roll tap for blind hole  Maschio a rullare per fori ciechi  Gewindeformer für Sacklöcher  Taraud à déformation pour trou borgne  Macho de laminación para agujero ciego  Раскатник для глухого отверстия

	<ul style="list-style-type: none">  Low spiral fluted tap blind hole  Elica 15° per fori ciechi  Sackloch Gewindebohrer mit geringem Drallwinkel  Hélice 15° pour trou débouchant  Hélice 15° para agujeros ciegos  Метчик с малым углом наклона канавки для глухого отверстия
	<ul style="list-style-type: none">  Spiral pointed tap through hole  Maschio con imbocco corretto per fori passanti  Gewindebohrer mit Schälanschnitt für Durchgangslöcher  Taraud à entrée corrigée pour trou débouchant  Machos con entrada corregida para agujero pasante  Спиральный метчик с подточкой для сквозного отверстия
	<ul style="list-style-type: none">  Straight fluted taps for through hole  Maschio a tagliente dritto per fori passanti  Geradegenuteter Gewindebohrer für Durchgangslöcher  Taraud à goujures droites pour trou débouchant  Macho con ranuras rectas para agujero pasante  Метчик с прямыми канавками для сквозного отверстия
	<ul style="list-style-type: none">  Roll tap for through hole  Maschio a rullare per fori passanti  Gewindeformer für Durchgangslöcher  Taraud à déformation pour trou débouchant  Macho de laminación para agujero pasante  Раскатник для сквозного отверстия

Coloured Rings

 Anelli Colorati  Gefärbte Ringe  Anneaux de Couleur  Anillos Colorados  Цветные кольца

	<ul style="list-style-type: none">  Hard steel 30~45 HRC  Acciaio 30~45 HRC  Stahl 30~45 HRC  Acier 30~45 HRC  Aceros 30~45 HRC  Стали 30~45 HRC
	<ul style="list-style-type: none">  Stainless steel and general steel  Acciai inossidabili e acciai (generale)  Rostfreie Stähle und allgemeine Stähle  Aciers inoxydables et aciers (général)  Aceros inoxidables y aceros  Нержавеющие стали и стали
	<ul style="list-style-type: none">  Cast iron  Ghisa  Gusseisen  Fonte  Fundición  Чугун
	<ul style="list-style-type: none">  Aluminium casting and diecasting (Si≤12%)  Fusioni e pressocolate di alluminio (Si ≤ 12%)  Aluminium-Gusslegierungen (Si ≤ 12%)  Aluminium moulé sous pression (Si ≤ 12%)  Fundiciones de aluminio (Si ≤ 12%)  Алюминий и порошковый алюминий (Si ≤ 12%)

	<ul style="list-style-type: none">  Nickel base alloy, alloy steel (CrMo, NiCrMo) and stainless steel (V4A)  Leghe a base di nichel, leghe di acciaio (CrMo, NiCrMo) e acciaio inox  Nickellegierungen, legierter Stahl (CrMo, NiCrMo) und Edelstahl  Alliage à base de nickel, acier allié (CrMo, NiCrMo) et acier inoxydable  Aleaciones base Nickel, aleaciones de acero (CrMo, NiCrMo) y aceros inoxidables  Сплавы на основе никеля, легированные стали (CrMo, NiCrMo) и нержавеющие стали
	<ul style="list-style-type: none">  Titanium alloy, alloy steel (CrMo, NiCrMo) ≥ 500 N/mm²  Leghe di titanio, leghe di acciaio (CrMo, NiCrMo) ≥ 500 N/mm²  Titanlegierungen, legierte Stähle (CrMo, NiCrMo) ≥ 500 N/mm²  Alliage de titane, acier allié (CrMo, NiCrMo) ≥ 500 N / mm²  Aleaciones de Titanio, Aleaciones de acero (CrMo, NiCrMo) ≥ 500 N/mm²  Сплавы титана, легированные стали (CrMo, NiCrMo) ≥ 500 N/mm²

SPIRAL FLUTED TAPS

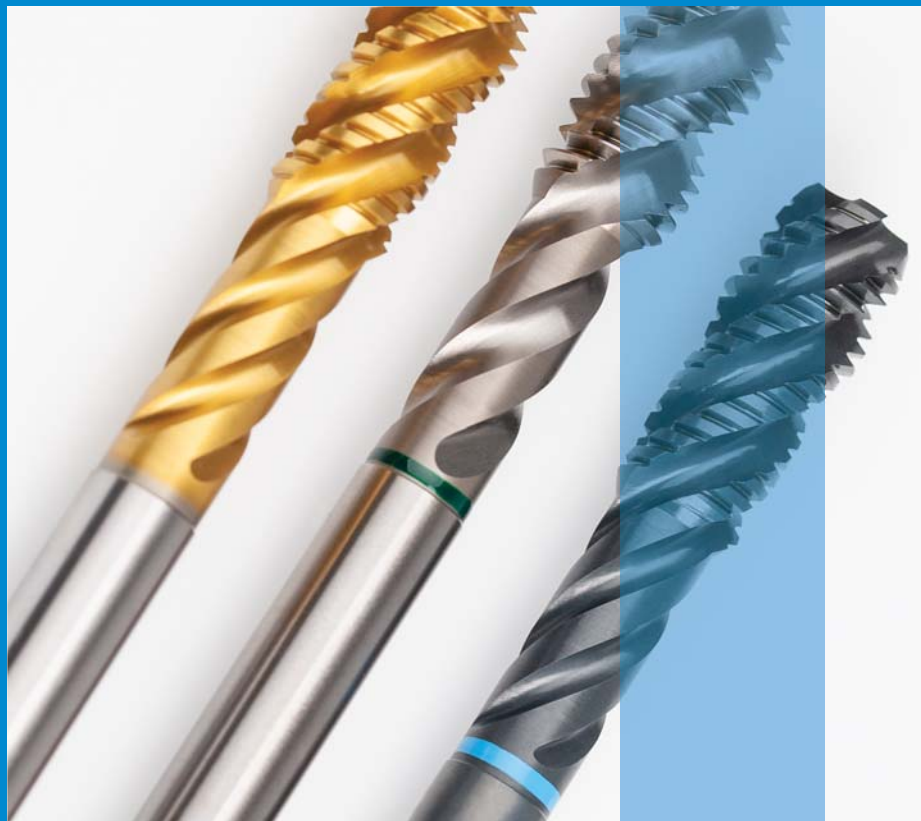

SP - DIN **080**
SP - JIS **152**
SP - ANSI **172**

Selection Chart

Intro

SP

SL

PO

ST

ROLL

CARBIDE

LONG

HAND TAPS

EG (STI)

SPECIAL THREADS, GAUGES

THREAD MILLS

DIES

CENTER DRILLS

Technical info

Z-PRO								GP General Purpose											
VUSP		VUSP E(1.5P)		AUSP G		AUSP Rp		AUSP Rc		HVSP		MHSP		SP					
HSS-P	COATING	HSS-P	COATING	HSS-E	COATING	HSS-E	COATING	HSS-E	COATING	HSS-E	OX	HSS-Co	COATING	HSS-E					
DIN																			
M	81	DIN	83	DIN		DIN		DIN		DIN	89	DIN	93	DIN	95	JIS	152	ANSI	
MF	81		83								89		93		96		154		
UNC/UNF											90				97		157		173
UNS, 8, 12, 20, 32UN											90						158		
UNEF																	159		
G (BSP)				84											98				
Rp (BSPP)						85													
Rc (BSPT)								87											
NPT																			
NPTF																			
NPSC, NPSM, NPSF																			
BSW																			159
EG(STI) M, MF, UNC/UNF																			
Pg																			
Tr																			
S miniature																			
Special threads																			
Vc (m/min)																			
P1	★ 10÷25	★ 10÷25	★ 10÷25	★ 5÷10	★ 5÷10	★ 5÷10	★ 5÷10	★ ≤7	★ ≤7	★ 3÷8	★ 3÷8				☆ 5÷10				
P2	★ 10÷25	★ 10÷25	★ 10÷25	★ 5÷10	★ 5÷10	★ 5÷10	★ 5÷10	★ ≤7	★ ≤7	★ 3÷8	★ 3÷8	★ 10÷30			★ 5÷10				
P3	★ 10÷25	★ 10÷25	★ 10÷25	★ 5÷10	★ 5÷10	★ 5÷10	★ 5÷10	★ ≤7	★ ≤7	★ 3÷8	★ 3÷8	★ 10÷25			☆ 5÷10				
P4	★ 10÷20	★ 10÷20	★ 10÷20	☆ 5÷10	☆ 5÷10	☆ 5÷10	☆ 5÷10	☆ ≤5	☆ ≤5	☆ 3÷8	☆ 3÷8	★ 10÷20			☆ 5÷8				
P5												☆ 10÷15							
P6																			
P7	★ 5÷15	★ 5÷15	★ 5÷15	★ ≤5	★ ≤5	★ ≤5	★ ≤5	★ ≤3	★ ≤3	★ 3÷8	★ 3÷8								
P8																			
M1	★ 5÷15	★ 5÷15	★ 5÷15	★ ≤5	★ ≤5	★ ≤5	★ ≤5	★ ≤3	★ ≤3	★ 3÷8	★ 3÷8								
M2	☆ 5÷10	☆ 5÷10	☆ 5÷10	★ ≤5	★ ≤5	★ ≤5	★ ≤5	★ ≤3	★ ≤3	★ 3÷8	★ 3÷8								
M3																			
K1																			
K2	☆ 10÷20	☆ 10÷20	☆ 10÷20	☆ ≤5	☆ ≤5	☆ ≤5	☆ ≤5	☆ ≤5	☆ ≤5										
K3																			
K4																			
N1	★ 10÷30	★ 10÷30	★ 10÷30	★ 5÷15	★ 5÷15	★ 5÷15	★ 5÷15	★ ≤10	★ ≤10						☆ 5÷10				
N2	★ 10÷30	★ 10÷30	★ 10÷30	★ 5÷15	★ 5÷15	★ 5÷15	★ 5÷15	★ ≤10	★ ≤10						☆ 5÷10				
N3	☆ 10÷25	☆ 10÷25	☆ 10÷25	☆ 5÷15	☆ 5÷15	☆ 5÷15	☆ 5÷15	☆ ≤10	☆ ≤10						☆ 5÷10				
N4	☆ 10÷20	☆ 10÷20	☆ 10÷20	☆ ≤5	☆ ≤5	☆ ≤5	☆ ≤5	☆ ≤5	☆ ≤5						☆ 5÷10				
N5																			
S1 (<25 HRC)																			
S2 (<35 HRC)																			
S3 (35 ÷ 45 HRC)																			
S5																			
H (45 ÷ 55 HRC)																			
H (55 ÷ 63 HRC)																			

★ 1st choice ☆ suitable

GP General Purpose									
SP ISO3(6G)	SP ISO2(6H)+50	SP ISO2(6H)+100	SP-BLF	SP 1.5P	SP-BLF 1.5P	SP LH	SP-BLF OX		
HSS-E	HSS-E	HSS-E	HSS-E	HSS-E	HSS-E	HSS-E	HSS-E	HSS-E	OX
DIN	DIN	DIN	DIN	JIS	DIN	DIN	JIS	DIN	
95	95	95	101	161	103	105	162	107	M
				161		105	163		MF
							163		UNC/UNF
									UNS, 8, 12, 20, 32UN
									UNEF
									G (BSP)
									Rp (BSPP)
									Rc (BSPT)
									NPT
									NPTF
									NPSC, NPSM, NPSF
							163		BSW
									EG(STI) M, MF, UNC/UNF
									Pg
									Tr
									S miniature
									Special threads
Vc (m/min)									
☆ 5÷10	☆ 5÷10	☆ 5÷10	☆ 5÷10	☆ 5÷10	☆ 5÷10	☆ 5÷10	☆ 5÷10	★ 5÷10	P1
★ 5÷10	★ 5÷10	★ 5÷10	★ 5÷10	★ 5÷10	★ 5÷10	★ 5÷10	★ 5÷10	★ 5÷10	P2
☆ 5÷10	☆ 5÷10	☆ 5÷10	☆ 5÷10	☆ 5÷10	☆ 5÷10	☆ 5÷10	☆ 5÷10	☆ 5÷10	P3
☆ 5÷8	☆ 5÷8	☆ 5÷8	☆ 5÷8	☆ 5÷8	☆ 5÷8	☆ 5÷8	☆ 5÷8	☆ 5÷8	P4
								☆ 4÷7	P5
									P6
								☆ 4÷8	P7
									P8
								☆ 4÷8	M1
									M2
									M3
									K1
									K2
									K3
									K4
☆ 5÷10	☆ 5÷10	☆ 5÷10	☆ 5÷10	☆ 5÷10	☆ 5÷10	☆ 5÷10	☆ 5÷10		N1
☆ 5÷10	☆ 5÷10	☆ 5÷10	☆ 5÷10	☆ 5÷10	☆ 5÷10	☆ 5÷10	☆ 5÷10		N2
☆ 5÷10	☆ 5÷10	☆ 5÷10	☆ 5÷10	☆ 5÷10	☆ 5÷10	☆ 5÷10	☆ 5÷10		N3
☆ 5÷10	☆ 5÷10	☆ 5÷10	☆ 5÷10	☆ 5÷10	☆ 5÷10	☆ 5÷10	☆ 5÷10		N4
									N5
									S1 (<25 HRC)
									S2 (<35 HRC)
									S3 (35 ÷ 45 HRC)
									S5
									H (45 ÷ 55 HRC)
									H (55 ÷ 63 HRC)

Selection Chart

Intro

SP

SL

PO

ST

ROLL

CARBIDE

LONG

HAND TAPS

EG (STI)

SPECIAL THREADS, GAUGES

THREAD MILLS

















DIES

CENTER DRILLS

Technical info

		GP General Purpose					MP Multi Purpose		MS Material Specific								
		SP OX		SP-BLF V		SP V		LO-SP		LO-SP OX		AU+SP		AUXSP		PH-SP	
		HSS-E	OX	HSS-E	COATING	HSS-E	COATING	HSS-E		HSS-E	OX	HSS-E	COATING	HSS-E	COATING	HSS-E	OX
																	
																	
																	
		DIN	DIN	DIN	DIN	DIN	DIN	DIN	DIN	DIN	DIN	DIN	DIN	DIN	DIN	DIN	DIN
M			113			117		118			121		123			125	
MF	109				115		117		119		121						125
UNC/UNF																	
UNS, 8, 12, 20, 32UN																	
UNEF																	
G (BSP)	110				115		117		119								125
Rp (BSPP)																	
Rc (BSPT)																	
NPT																	
NPTF																	
NPSC, NPSM, NPSF																	
BSW																	
EG(STI) M, MF, UNC/UNF																	
Pg																	
Tr																	
S miniature																	
Special threads																	
		Vc (m/min)															
P1	★	5÷10	★	10÷20	★	10÷20				★	10÷20	★	10÷25				
P2	★	5÷10	★	10÷20	★	10÷20	★	5÷10	★	5÷10	★	10÷20	★	10÷25			
P3	☆	5÷10	★	10÷20	★	10÷20	★	5÷10	★	5÷10	★	10÷20	★	10÷25	☆	5÷10	
P4	☆	5÷8	★	10÷15	★	10÷15	☆	5÷10	★	5÷10	★	10÷20	★	10÷25	★	2÷7	
P5	☆	4÷7													★	≤5	
P6																	
P7	☆	4÷8	☆	6÷12	☆	6÷12					★	5÷12	★	5÷15			
P8																	
M1	☆	4÷8	☆	6÷12	☆	6÷12					★	5÷12	★	5÷15			
M2											★	5÷10	★	5÷10			
M3																	
K1							☆	5÷10									
K2							☆	5÷10			☆	5÷15	☆	10÷25			
K3							☆	5÷10									
K4																	
N1			☆	10÷20	☆	10÷20	☆	5÷10			★	20÷30	★	20÷30			
N2			☆	10÷20	☆	10÷20	☆	5÷10			★	20÷30	★	20÷30			
N3			☆	10÷20	☆	10÷20	☆	5÷10			☆	10÷20	☆	15÷25			
N4			☆	10÷20	☆	10÷20	☆	5÷10			☆	10÷20	☆	15÷25			
N5																	
S1 (<25 HRC)																	
S2 (<35 HRC)																	
S3 (35 ÷ 45 HRC)																	
S5																	
H (45 ÷ 55 HRC)																	
H (55 ÷ 63 HRC)																	

★ 1st choice ☆ suitable

MS Material Specific														
PM-SP	PMSP		SP+VA		SP-VA		SP-VA ISO3(6G)		SU+SP/SU-SP	ZELX SS SP		ZELX SS NPT		
HSS-P	HSS-P	OX	HSS-E	OX	HSS-E	OX	HSS-E	OX	HSS-E	OX	HSS-E	OX	HSS-E	OX
														
														
DIN	DIN	DIN	DIN	DIN	DIN	JIS	ANSI	ANSI						
127		131	133	133	133	164								M
127			133	133	133	166								MF
			134	134	134	167	176							UNC/UNF
			135	135	135									UNS, 8, 12, 20, 32UN
				135	135									UNEF
														G (BSP)
														Rp (BSPP)
	129													Rc (BSPT)
													180	NPT
														NPTF
														NPSC, NPSM, NPSF
						167								BSW
														EG(STI) M, MF, UNC/UNF
														Pg
														Tr
														S miniature
														Special threads
Vc (m/min)														
			★ ≤10	★ ≤10	★ ≤10	★ ≤10	★ ≤10	★ ≤10	★ ≤10	★ ≤10	★ ≤10	★ ≤10	★ ≤5	P1
			★ ≤10	★ ≤10	★ ≤10	★ ≤10	★ ≤10	★ ≤10	★ ≤10	★ ≤10	★ ≤10	★ ≤10	★ ≤5	P2
☆ 2÷10	☆ ≤5		★ ≤10	★ ≤10	★ ≤10	★ ≤10	★ ≤10	★ ≤10	★ ≤10	★ ≤10	★ ≤10	★ ≤10	★ ≤5	P3
★ 2÷7	★ ≤5		☆ ≤10	☆ ≤10	☆ ≤10	☆ ≤10	☆ ≤10	☆ ≤10	☆ ≤10	☆ ≤10	☆ ≤10	☆ ≤10	☆ ≤5	P4
★ 2÷7	★ ≤5													P5
★ 2÷5	★ ≤5													P6
			★ ≤10	★ ≤10	★ ≤10	★ ≤10	★ ≤10	★ ≤10	★ ≤10	★ ≤10	★ ≤10	★ ≤10	★ ≤5	P7
														P8
			★ ≤10	★ ≤10	★ ≤10	★ ≤10	★ ≤10	★ ≤10	★ ≤10	★ ≤10	★ ≤10	★ ≤10	★ ≤5	M1
												★ ≤5		M2
														M3
														K1
														K2
														K3
														K4
														N1
														N2
														N3
														N4
														N5
														S1 (<25 HRC)
														S2 (<35 HRC)
														S3 (35 ÷ 45 HRC)
														S5
														H (45 ÷ 55 HRC)
														H (55 ÷ 63 HRC)

Selection Chart

Intro

SP

SL

PO

ST

ROLL

CARBIDE

LONG

HAND TAPS

EG (STI)

















SPECIAL THREADS, GAUGES

THREAD MILLS













DIES

CENTER DRILLS

Technical info

MS Material Specific																													
ZELX SS NPTF	SP-VA TiCN		SU2-SP		AL+SP/AL-SP		AL-SP 1.5P		ZELX AL SP	ZEN-B		ZELX NI SP																	
HSS-E OX	HSS-E COATING	HSS-E OX	HSS-E NI	HSS-E NI	HSS-E NI	HSS-E NI	HSS-P OX	HSS-P NX																					
																													
																													
ANSI										DIN										JIS									
M	137		139		141		169		171				142																
MF							169		171				143																
UNC/UNF											183		143		185														
UNS, 8, 12, 20, 32UN																													
UNEF																													
G (BSP)			139																										
Rp (BSPP)																													
Rc (BSPT)																													
NPT																													
NPTF	181																												
NPSC, NPSM, NPSF																													
BSW																													
EG(STI) M, MF, UNC/UNF																													
Pg																													
Tr																													
S miniature																													
Special threads																													
Vc (m/min)										Vc (m/min)																			
P1																	☆ 5÷15												
P2	★ ≤5	★ ≤15															☆ 5÷15												
P3	★ ≤5	★ ≤15											★ 5÷15	★ 5÷15			★ 5÷15												
P4	☆ ≤5	☆ ≤15											★ 5÷15	★ 5÷15			★ 5÷15												
P5													☆ 5÷10	☆ 5÷10			☆ 5÷10												
P6																													
P7	★ ≤5	★ ≤15											★ 5÷15	★ 5÷15			★ 5÷15												
P8													★ 4÷8	★ 4÷8			★ 4÷8												
M1	★ ≤5	★ ≤15	☆ 5÷15											★ 5÷15	★ 5÷15			★ 5÷15											
M2	★ ≤5		★ 5÷15											★ 5÷15	★ 5÷15			★ 5÷15											
M3			★ 5÷12											★ 4÷8	★ 4÷8			★ 4÷8											
K1																													
K2																													
K3																													
K4																													
N1							★ 10÷25	★ 10÷25	★ 10÷25																				
N2							★ 10÷25	★ 10÷25	★ 10÷25																				
N3							★ 10÷25	★ 10÷25	★ 10÷25																				
N4							★ 10÷25	★ 10÷25	★ 10÷25																				
N5																													
S1 (<25 HRC)			☆ 3÷7										★ 5÷10	★ 5÷10			★ 5÷10												
S2 (<35 HRC)													★ 5÷10	★ 5÷10			★ 5÷10												
S3 (35 ÷ 45 HRC)																													
S5																													
H (45 ÷ 55 HRC)																													
H (55 ÷ 63 HRC)																													

★ 1st choice ☆ suitable

MS Material Specific		HS High Speed									
ZET-B		ZELX TI SP		F-SP	HFIHS	HFISP	HFAHS	HFASP			
HSS-P	NI	HSS-P	NI	HSS-E	COATING	HSS-Co	COATING	HSS-Co	COATING	HSS-Co	COATING
											
											
DIN	ANSI	DIN	DIN	DIN	DIN	DIN	DIN	DIN			
144		146	147	148	149	151	M				
145		146	147	148	149	151	MF				
145	188						UNC/UNF				
							UNS, 8, 12, 20, 32UN				
							UNEF				
							G (BSP)				
							Rp (BSPP)				
							Rc (BSPT)				
							NPT				
							NPTF				
							NPSC, NPSM, NPSF				
							BSW				
							EG(STI) M, MF, UNC/UNF				
							Pg				
							Tr				
							S miniature				
							Special threads				
Vc (m/min)											
		★ 15÷25	★ 20÷50	★ 20÷50					P1		
		★ 15÷25	★ 20÷50	★ 20÷50					P2		
		☆ 15÷25	★ 20÷30	★ 20÷30					P3		
☆ 5÷10	☆ 5÷10	☆ 15÷25	★ 20÷30	★ 20÷30					P4		
☆ 5÷8	☆ 5÷8		☆ 15÷25	☆ 15÷25					P5		
☆ 3÷6	☆ 3÷6								P6		
		☆ 10÷20	☆ 15÷30	☆ 15÷30					P7		
☆ 3÷6	☆ 3÷6								P8		
		☆ 10÷20	☆ 15÷30	☆ 15÷30					M1		
		☆ 10÷20	☆ 15÷25	☆ 15÷25					M2		
☆ 3÷6	☆ 3÷6								M3		
			☆ 20÷40	★ 20÷40					K1		
☆ 5÷10	☆ 5÷10		☆ 20÷40	★ 20÷40					K2		
☆ 5÷10	☆ 5÷10								K3		
									K4		
		★ 15÷30				★ 30÷100	★ 30÷100		N1		
		★ 15÷30				★ 30÷100	★ 30÷100		N2		
									N3		
						☆ 30÷60	☆ 30÷60		N4		
									N5		
☆ 5÷10	☆ 5÷10								S1 (<25 HRC)		
☆ 5÷10	☆ 5÷10								S2 (<35 HRC)		
★ 3÷6	☆ 3÷6								S3 (35 ÷ 45 HRC)		
★ 5÷10	★ 5÷10								S5		
									H (45 ÷ 55 HRC)		
									H (55 ÷ 63 HRC)		

Intro

VUSP

Z-PRO Series

HSSP Spiral Fluted Taps, Coated



SP

DIN

SL



PO

Recommended Tapping Speeds Depending On Materials

ISO	Vc (m/min)	ISO	Vc (m/min)	ISO	Vc (m/min)	ISO	Vc (m/min)
P1	10÷25 ★	M1	5÷15 ★	K2	10÷20 ☆	N1	10÷30 ★
P2	10÷25 ★	M2	5÷10 ☆			N2	10÷30 ★
P3	10÷25 ★					N3	10÷25 ☆
P4	10÷20 ★					N4	10÷20 ☆
P7	5÷15 ★						

★ 1st choice ☆ suitable

FEATURES

Longer Life - Great improvement thanks to the new premium grade of powder high speed steel and new special coating.

New Flute Shape - Improved chip ejection, reduced cutting resistance and excellent internal threads finishing thanks to unique flute shape.

For wide range of workpiece materials: steel, alloy steel, stainless steel and aluminium.



WATCH THE VIDEO

ROLL

CARBIDE

Product Features

Lubricant	Hole shape	Hand tapping	Drilling machine	Low speed	Middle speed	
Emulsion					VUSP Vc ≤ 25 m/min	
					VUPO	
Oil		HTset	ISP	SP	SP V	AU+SP
		IHT	IPO	PO	PO V	AU+SL

SPECIAL THREADS, GAUGES

Process Data

M3×0.5

Work-material	Ck50 - 1.1213
Thread length	4.5 mm
Tapping speed	20 m/min
Machine	Vertical machining center
Lubricant	Water soluble oil

No wear after 250 threads with VUSP

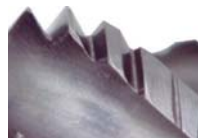

THREAD MILLS

DIES

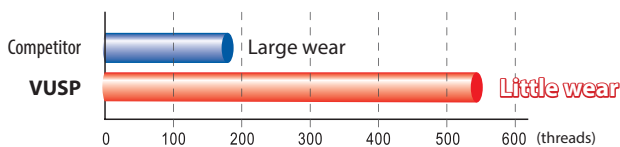

CENTER DRILLS

Technical info

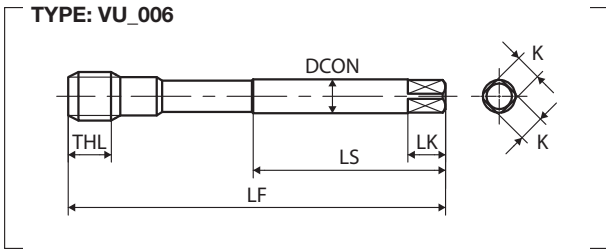
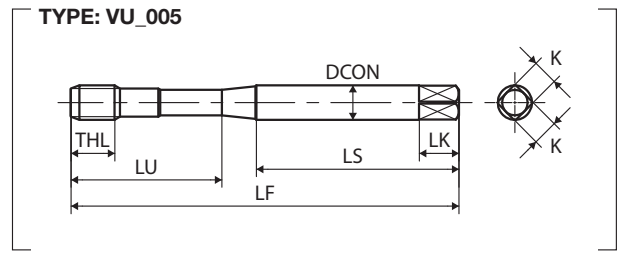
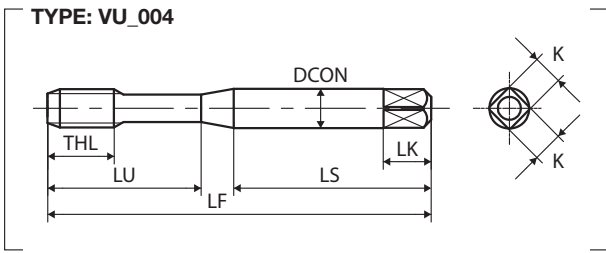

M	TCTR (tolerance)	\varnothing (mm)	Hole \varnothing (mm)	Code	THCHT (chamfer)	LF (mm)	LT (mm)	THL (mm)	LU (mm)	LS (mm)	DCON (mm)	K (mm)	LK (mm)	NOF	Type	Stock
DIN 371																
M3X0.5	ISO2X(6HX)	2.5	2.56	3101101035	2.5P	56	-	5	18	34	3.5	2.7	6	3	004	●
M4X0.7	ISO2X(6HX)	3.3	3.38	3101101042	2.5P	63	-	7	21	38	4.5	3.4	6	3	004	●
M5X0.8	ISO2X(6HX)	4.2	4.28	3101101049	2.5P	70	-	9	25	39	6	4.9	8	3	004	●
M6X1	ISO2X(6HX)	5	5.09	3101101055	2.5P	80	-	11	30	45	6	4.9	8	3	004	●
M8X1.25	ISO2X(6HX)	6.8	6.85	3101101064	2.5P	90	-	12	35	47	8	6.2	9	3	005	●
M10X1.5	ISO2X(6HX)	8.5	8.6	3101101078	2.5P	100	-	13	39	52.5	10	8	11	3	005	●
DIN 376																
M12X1.75	ISO2X(6HX)	10.3	10.36	3101101088	2.5P	110	-	15	-	56	9	7	10	3	006	●
M14X2	ISO2X(6HX)	12	12.12	3101101100	2.5P	110	-	18	-	56	11	9	12	3	006	●
M16X2	ISO2X(6HX)	14	14.12	3101101114	2.5P	110	-	18	-	56	12	9	12	3	006	●
DIN 371																
M3X0.35	ISO2X(6HX)	2.65	2.7	3101101036	2.5P	56	-	5	18	34	3.5	2.7	6	3	004	●
M4X0.5	ISO2X(6HX)	3.5	3.56	3101101043	2.5P	63	-	5	21	38	4.5	3.4	6	3	004	●
M5X0.5	ISO2X(6HX)	4.5	4.56	3101101051	2.5P	70	-	6	25	39	6	4.9	8	3	004	●
M6X0.75	ISO2X(6HX)	5.25	5.33	3101101056	2.5P	80	-	8	30	45	6	4.9	8	3	004	●
M6X0.5	ISO2X(6HX)	5.5	5.56	3101101057	2.5P	80	-	8	30	45	6	4.9	8	3	004	●
DIN 374																
M8X1	ISO2X(6HX)	7	7.09	3101101065	2.5P	90	-	12	-	46	6	4.9	8	3	006	●
M10X1.25	ISO2X(6HX)	8.8	8.85	3101101079	2.5P	100	-	13	-	51	7	5.5	8	3	006	●
M10X1	ISO2X(6HX)	9	9.09	3101101080	2.5P	90	-	13	-	46	7	5.5	8	3	006	●
M12X1.5	ISO2X(6HX)	10.5	10.6	3101101089	2.5P	100	-	15	-	51	9	7	10	3	006	●
M12X1.25	ISO2X(6HX)	10.8	10.85	3101101090	2.5P	100	-	15	-	51	9	7	10	3	006	●
M14X1.5	ISO2X(6HX)	12.5	12.6	3101101102	2.5P	100	-	14	-	51	11	9	12	3	006	●
M16X1.5	ISO2X(6HX)	14.5	14.6	3101101116	2.5P	100	-	14	-	51	12	9	12	3	006	●

Intro

SP

DIN

SL

PO

ST

ROLL

CARBIDE

LONG

HAND TAPS

EG (STI)

SPECIAL THREADS, GAUGES

THREAD MILLS

DIES

CENTER DRILLS

Technical info

Intro

VUSP E(1.5P)

Z Z-PRO Series

HSSP Spiral Fluted Taps 1.5P, Coated

SP

DIN

SL

PO

ST

ROLL

CARBIDE

LONG

HAND TAPS

EG (STI)

SPECIAL THREADS, GAUGES

THREAD MILLS

DIES

CENTER DRILLS

Technical info



FEATURES

Longer Life - Great improvement thanks to the new premium grade of powder high speed steel and new special coating.

New Flute Shape - Improved chip ejection, reduced cutting resistance and excellent internal threads finishing thanks to unique flute shape.

1.5P spiral fluted tap for wide range of workpiece materials: steel, alloy steel, stainless steel and aluminium.



WATCH THE VIDEO

Recommended Tapping Speeds Depending On Materials

ISO	Vc (m/min)	ISO	Vc (m/min)	ISO	Vc (m/min)	ISO	Vc (m/min)
P1	10÷25 ★	M1	5÷15 ★	K2	10÷20 ☆	N1	10÷30 ★
P2	10÷25 ★	M2	5÷10 ☆			N2	10÷30 ★
P3	10÷25 ★					N3	10÷25 ☆
P4	10÷20 ★					N4	10÷20 ☆
P7	5÷15 ★						

★ 1st choice ☆ suitable

TYPE: VU_004

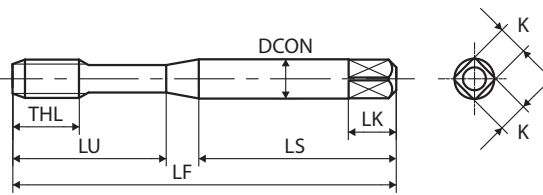

TYPE: VU_005

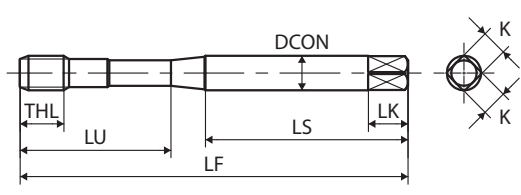

TYPE: VU_006

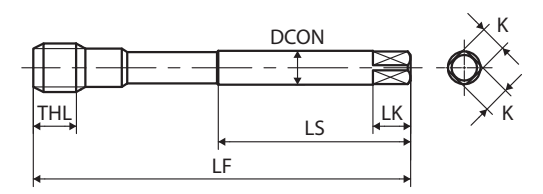

M	TCTR (tolerance)	 Hole Ø (mm)	Hole Ø (mm)	Code	THCHT (chamfer)	LF (mm)	LT (mm)	THL (mm)	LU (mm)	LS (mm)	DCON (mm)	K (mm)	LK (mm)	NOF	Type	Stock
DIN 371																
M3X0.5	ISO2X(6HX)	2.5	2.56	3103101035	1.5P	56	-	5	18	34	3.5	2.7	6	3	004	●
M4X0.7	ISO2X(6HX)	3.3	3.38	3103101042	1.5P	63	-	7	21	38	4.5	3.4	6	3	004	●
M5X0.8	ISO2X(6HX)	4.2	4.28	3103101049	1.5P	70	-	9	25	39	6	4.9	8	3	004	●
M6X1	ISO2X(6HX)	5	5.09	3103101055	1.5P	80	-	11	30	45	6	4.9	8	3	004	●
M8X1.25	ISO2X(6HX)	6.8	6.85	3103101064	1.5P	90	-	12	35	47	8	6.2	9	3	005	●
M10X1.5	ISO2X(6HX)	8.5	8.6	3103101078	1.5P	100	-	13	39	52.5	10	8	11	3	005	●
DIN 376																
M12X1.75	ISO2X(6HX)	10.3	10.36	3103101088	1.5P	110	-	15	-	56	9	7	10	3	006	●
M14X2	ISO2X(6HX)	12	12.12	3103101100	1.5P	110	-	18	-	56	11	9	12	3	006	●
M16X2	ISO2X(6HX)	14	14.12	3103101114	1.5P	110	-	18	-	56	12	9	12	3	006	●
DIN 371																
M3X0.35	ISO2X(6HX)	2.65	2.7	3103101036	1.5P	56	-	5	18	34	3.5	2.7	6	3	004	○
M4X0.5	ISO2X(6HX)	3.5	3.56	3103101043	1.5P	63	-	5	21	38	4.5	3.4	6	3	004	○
M5X0.5	ISO2X(6HX)	4.5	4.56	3103101051	1.5P	70	-	6	25	39	6	4.9	8	3	004	○
M6X0.75	ISO2X(6HX)	5.25	5.33	3103101056	1.5P	80	-	8	30	45	6	4.9	8	3	004	○
M6X0.5	ISO2X(6HX)	5.5	5.56	3103101057	1.5P	80	-	8	30	45	6	4.9	8	3	004	○
DIN 374																
M8X1	ISO2X(6HX)	7	7.09	3103101065	1.5P	90	-	12	-	46	6	4.9	8	3	006	●
M10X1.25	ISO2X(6HX)	8.8	8.85	3103101079	1.5P	100	-	13	-	51	7	5.5	8	3	006	●
M10X1	ISO2X(6HX)	9	9.09	3103101080	1.5P	90	-	13	-	46	7	5.5	8	3	006	●
M12X1.5	ISO2X(6HX)	10.5	10.6	3103101089	1.5P	100	-	15	-	51	9	7	10	3	006	●
M12X1.25	ISO2X(6HX)	10.8	10.85	3103101090	1.5P	100	-	15	-	51	9	7	10	3	006	●
M14X1.5	ISO2X(6HX)	12.5	12.6	3103101102	1.5P	100	-	14	-	51	11	9	12	3	006	●
M16X1.5	ISO2X(6HX)	14.5	14.6	3103101116	1.5P	100	-	14	-	51	12	9	12	3	006	●

Intro

SP
DIN

SL

PO

ST

ROLL

CARBIDE

LONG

HAND
TAPS

EG (STI)

SPECIAL
THREADS,
GAUGES

THREAD
MILLS

DIES

CENTER
DRILLS

Technical
info

Intro

AUSP G

Z-PRO Series

Spiral Fluted Taps for Parallel Pipe Threads, Coated



SP

DIN

SL



FEATURES

Z-PRO Series for blind hole application on wide range of materials

A unique cutting edge geometry and special coating allow excellent surface finish and long life.

PO

Recommended Tapping Speeds Depending On Materials

ISO	Vc (m/min)	ISO	Vc (m/min)	ISO	Vc (m/min)	ISO	Vc (m/min)
P1	5÷10 ★	M1	≤5 ★	K2	≤5 ☆	N1	5÷15 ★
P2	5÷10 ★	M2	≤5 ★			N2	5÷15 ★
P3	5÷10 ★					N3	5÷15 ☆
P4	5÷10 ☆					N4	≤5 ☆
P7	≤5 ★						

★ 1st choice ☆ suitable



WATCH THE VIDEO

ROLL

Process Data

AUSP G 1/4-19

Work-material	St 44-3 - 1.0144
Tapping speed	5 m/min
Machine	Machining center
Holder	Rigid
Lubricant	Water soluble oil

Smooth chip ejection



Excellent surface finish



CARBIDE

LONG

HAND TAPS

EG (STI)

SPECIAL THREADS, GAUGES

THREAD MILLS

DIES

CENTER DRILLS

Technical info

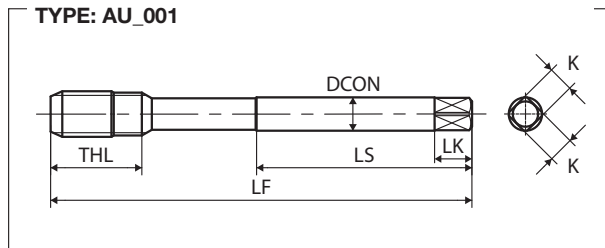

G(BSP)	TCTR (tolerance)	∅ (mm)	Hole ∅ (mm)	Code	THCHT (chamfer)	Basic major ∅ (mm)	LF (mm)	THL (mm)	LS (mm)	DCON (mm)	K (mm)	LK (mm)	NOF	Type	Stock
DIN YMW															
1/8-28	P3	8.75	8.78	SJG0020FET	2.5P	9.728	90	15	46	8	6	9	3	001	●
1/4-19	P3.5	11.75	11.78	SJG0040FET	2.5P	13.157	100	19	51	11	9	12	3	001	●
3/8-19	P3.5	15.25	15.28	SJG0060FET	2.5P	16.662	100	21	51	14	11	14	3	001	●
1/2-14	P4	19	19.04	SJG0080FET	2.5P	20.955	125	26	64	18	14	17	4	001	●
3/4-14	P4	24.5	24.52	SJG0120FET	2.5P	26.441	140	28	71	23	17	20	4	001	●
1-11	P5	30.75	30.77	SJG0160FET	2.5P	33.249	160	33	82	26	21	24	4	001	●

AUSP Rp

Z-PRO Series

Spiral Fluted Taps for Parallel Pipe Threads, Coated



FEATURES

Z-PRO Series for blind hole application on wide range of materials

A unique cutting edge geometry and special coating allow excellent surface finish and long life.

Recommended Tapping Speeds Depending On Materials

ISO	Vc (m/min)	ISO	Vc (m/min)	ISO	Vc (m/min)	ISO	Vc (m/min)
P1	5÷10 ★	M1	≤5 ★	K2	≤5 ☆	N1	5÷15 ★
P2	5÷10 ★	M2	≤5 ★			N2	5÷15 ★
P3	5÷10 ★					N3	5÷15 ☆
P4	5÷10 ☆					N4	≤5 ☆
P7	≤5 ★						

★ 1st choice ☆ suitable



WATCH THE VIDEO

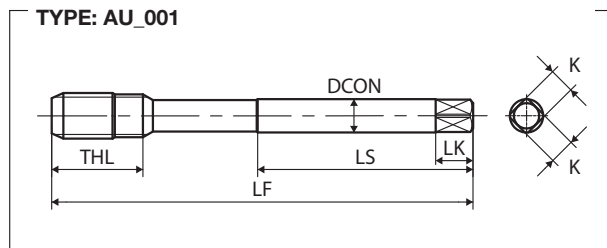

Rp(BSPP)	TCTR (tolerance)	Hole Ø (mm)	Hole Ø (mm)	Code	THCHT (chamfer)	Basic major Ø (mm)	LF (mm)	THL (mm)	LS (mm)	DCON (mm)	K (mm)	LK (mm)	NOF	Type	Stock
DIN YMW															
1/8-28	-	8.5	8.55	SJRP020FET	2.5P	9.728	90	15	46	8	6	9	3	001	●
1/4-19	-	11.4	11.5	SJRP040FET	2.5P	13.157	100	19	51	11	9	12	3	001	●
3/8-19	-	14.8	14.9	SJRP060FET	2.5P	16.662	100	21	51	14	11	14	3	001	●
1/2-14	-	18.5	18.55	SJRP080FET	2.5P	20.955	125	26	64	18	14	17	4	001	●
3/4-14	-	24	24.1	SJRP120FET	2.5P	26.441	140	28	71	23	17	20	4	001	●
1-11	-	30.2	30.25	SJRP160FET	2.5P	33.249	160	33	82	26	21	24	4	001	●

- Intro
- SP**
- DIN**
- SL
- PO
- ST
- ROLL
- CARBIDE
- LONG
- HAND TAPS
- EG (STI)
- SPECIAL THREADS, GAUGES
- THREAD MILLS
- DIES
- CENTER DRILLS
- Technical info

Intro

AUSP Rc

Z-PRO Series

Spiral Fluted Taps for Taper Pipe Threads, Coated



SP

DIN

SL

PO

ST

ROLL

CARBIDE

LONG

HAND TAPS

EG (STI)

SPECIAL THREADS, GAUGES

THREAD MILLS

DIES

CENTER DRILLS

Technical info

FEATURES

Standard and Long shank Z-PRO Series for extended overhang on blind hole application on wide range of materials.

A unique cutting edge geometry and special coating allow excellent surface finish and long life.

Recommended Tapping Speeds Depending On Materials

ISO	Vc (m/min)	★	ISO	Vc (m/min)	★	ISO	Vc (m/min)	☆	ISO	Vc (m/min)	★
P1	≤7	★	M1	≤3	★	K2	≤5	☆	N1	≤10	★
P2	≤7	★	M2	≤3	★				N2	≤10	★
P3	≤7	★							N3	≤10	☆
P4	≤5	☆							N4	≤5	☆
P7	≤3	★									

★ 1st choice ☆ suitable



WATCH THE VIDEO

Product Features

AUSP Rc (PT) 1/4-19

Work-material	St 44-3 - 1.0144
Tapping speed	5 m/min
Machine	Machining center
Holder	Tap holder with tension/compression
Lubricant	Water soluble oil

Excellent surface finish



Competitor's spiral fluted tap



Bored Hole Ø (mm) A - B

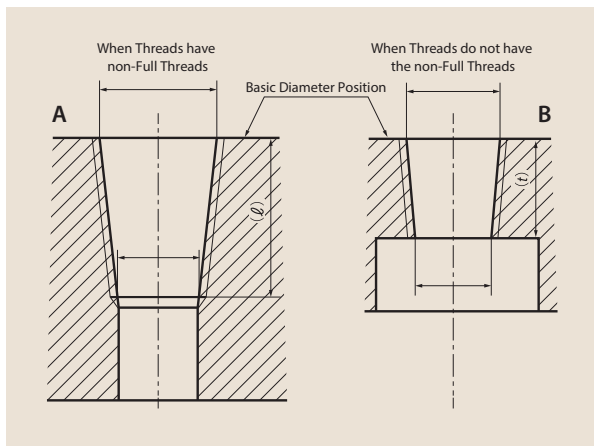

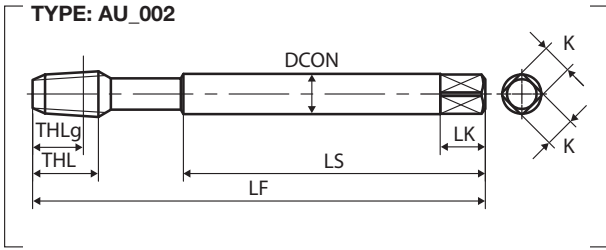

Rc(BSPT)	TCTR (tolerance)	Bored Hole Ø (mm)		Code	THCHT (chamfer)	Basic major Ø (mm)	LF (mm)	THL (mm)	THLg (mm)	LS (mm)	DCON (mm)	K (mm)	LK (mm)	NOF	Type	Stock
		A	B													
DIN YMW																
1/16-28	-	6.1	6.2	SJRC010FET	2.5P	7.723	90	14	10.1	60	8	6	9	3	002	○
1/8-28	-	8.1	8.2	SJRC020FET	2.5P	9.728	90	15	10.1	46	8	6	9	3	002	●
	-	8.1	8.2	SJRC020FETG	2.5P	9.728	150	15	10.1	40	8	6	9	3	002	○
	-	8.1	8.2	SJRC020FETK	2.5P	9.728	200	15	10.1	40	8	6	9	3	002	○
1/4-19	-	10.7	10.9	SJRC040FET	2.5P	13.157	100	19	15	51	11	9	12	3	002	●
	-	10.7	10.9	SJRC040FETG	2.5P	13.157	150	19	15	50	11	9	12	3	002	○
	-	10.7	10.9	SJRC040FETK	2.5P	13.157	200	19	15	50	11	9	12	3	002	○
3/8-19	-	14.2	14.4	SJRC060FET	2.5P	16.662	100	21	15.4	51	14	11	14	3	002	●
	-	14.2	14.4	SJRC060FETG	2.5P	16.662	150	21	15.4	50	14	11	14	3	002	○
	-	14.2	14.4	SJRC060FETK	2.5P	16.662	200	21	15.4	50	14	11	14	3	002	○
1/2-14	-	17.6	17.9	SJRC080FET	2.5P	20.955	125	26	20.5	64	18	14	17	4	002	●
	-	17.6	17.9	SJRC080FETK	2.5P	20.955	200	26	20.5	60	18	14	17	4	002	○
3/4-14	-	23	23.3	SJRC120FET	2.5P	26.441	140	28	21.8	71	23	17	20	4	002	●
	-	23	23.3	SJRC120FETK	2.5P	26.441	200	28	21.8	70	23	17	20	4	002	○
1-11	-	29	29.3	SJRC160FET	2.5P	33.249	160	33	26	82	26	21	24	4	002	●
	-	29	29.3	SJRC160FETK	2.5P	33.249	200	33	26	70	26	21	24	4	002	○

Intro

SP
DIN

SL

PO

ST

ROLL

CARBIDE

LONG

HAND
TAPS

EG (STI)

SPECIAL
THREADS,
GAUGES

THREAD
MILLS

DIES

CENTER
DRILLS

Technical
info

Intro

HVSP

Z-PRO Series

SP
DIN Spiral Fluted Taps for large forged parts in the heavy metalworking industry



SL



FEATURES

Z-PRO Series with BLF design for blind hole application. Special geometry reduces cutting edge chipping resulting in stable and longer life on steel, alloy steel and stainless steel application. OX treatment reduces welding troubles.

PO

Recommended Tapping Speeds Depending On Materials

ISO	Vc (m/min)	★	ISO	Vc (m/min)	★
P1	3÷8	★	M1	3÷8	★
P2	3÷8	★	M2	3÷8	★
P3	3÷8	★			
P4	3÷8	☆			
P7	3÷8	★			

★ 1st choice ☆ suitable

ST



WATCH THE VIDEO

ROLL

Tapping with HVSP No chipping

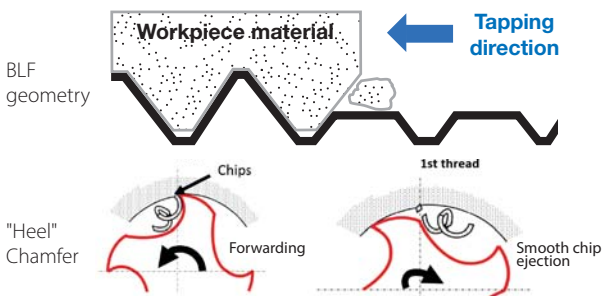

Tapping with conventional SP Chipping occurs on thread portion

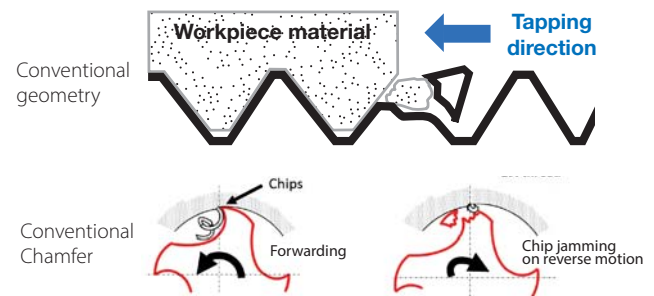

CARBIDE

LONG

HAND TAPS

No chipping

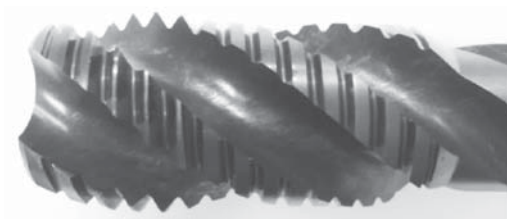

Chipping

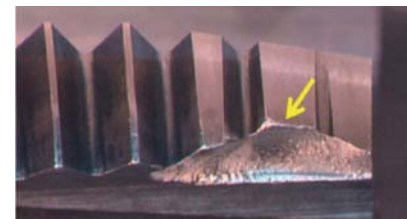

EG (STI)

SPECIAL THREADS, GAUGES

THREAD MILLS

Smooth chip ejection by HVSP



Entangled chips



DIES

CENTER DRILLS

Technical info

Designed to avoid chipping problems



Advanced cutting edge

Special cutting edge geometry prevents chip incursion from the back side of chamfer thread portion during reverse motion

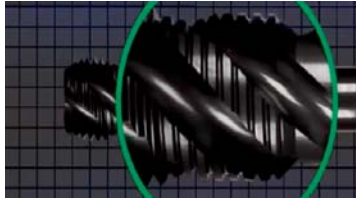

BLF shape on full thread portion

The BLF shape produces excellent cutting performances enabling the prevention of flute chipping problems

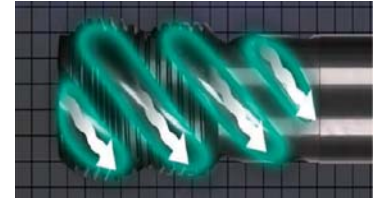

Unique flute design

Unique flute design for smooth chip ejection

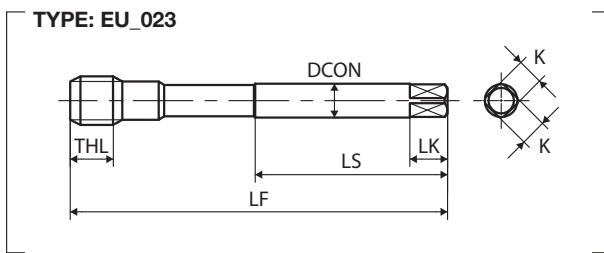

M	TCTR (tolerance)	∅ (mm)	Hole ∅ (mm)	Code	THCHT (chamfer)	LF (mm)	LT (mm)	THL (mm)	LU (mm)	LS (mm)	DCON (mm)	K (mm)	LK (mm)	NOF	Type	Stock
DIN 376																
M12X1.75	ISO2X(6HX)	10.3	10.36	SG012PSEEXJ	2.5P	110	-	26	-	56	9	7	10	3	023	●
M14X2	ISO2X(6HX)	12	12.12	SG014QSEEXJ	2.5P	110	-	26	-	56	11	9	12	3	023	●
M16X2	ISO2X(6HX)	14	14.12	SG016QSEEXJ	2.5P	110	-	26	-	56	12	9	12	3	023	●
M18X2.5	ISO2X(6HX)	15.5	15.63	SG018RTEEXJ	2.5P	125	-	33	-	64	14	11	14	4	023	●
M20X2.5	ISO2X(6HX)	17.5	17.63	SG020RTEEXJ	2.5P	140	-	33	-	71	16	12	15	4	023	●
M22X2.5	ISO2X(6HX)	19.5	19.63	SG022RTEEXJ	2.5P	140	-	33	-	71	18	14.5	17	4	023	●
M24X3	ISO2X(6HX)	21	21.13	SG024STEEXJ	2.5P	160	-	37	-	82	18	14.5	17	4	023	●
M27X3	ISO2X(6HX)	24	24.13	SG027STEEXJ	2.5P	160	-	37	-	82	20	16	19	4	023	●
M30X3.5	ISO2X(6HX)	26.5	26.63	SG030TBEEEXJ	2.5P	180	-	44	-	92	22	18	21	4	023	●
M33X3.5	ISO2X(6HX)	29.5	29.63	SG033TBEEEXJ	2.5P	180	-	46	-	92	25	20	23	4	023	●
M36X4	ISO2X(6HX)	32	32.12	SG036UBEEXJ	2.5P	200	-	52	-	102	28	22	25	4	023	●
M39X4	ISO2X(6HX)	35	35.12	SG039UBEEXJ	2.5P	200	-	52	-	102	32	24	27	4	023	●
M42X4.5	ISO2X(6HX)	37.5	37.63	SG042VBEEXJ	2.5P	200	-	59	-	102	32	24	27	4	023	●
M48X5	ISO2X(6HX)	43	43.12	SG048WBEEXJ	2.5P	250	-	65	-	128	36	29	32	4	023	●
MF	TCTR (tolerance)	∅ (mm)	Hole ∅ (mm)	Code	THCHT (chamfer)	LF (mm)	LT (mm)	THL (mm)	LU (mm)	LS (mm)	DCON (mm)	K (mm)	LK (mm)	NOF	Type	Stock
DIN 374																
M30X3	ISO2X(6HX)	27	27.13	SM030SUEEXJ	2.5P	180	-	44	-	92	22	18	21	4	023	●
M33X3	ISO2X(6HX)	30	30.13	SM033SUEEXJ	2.5P	180	-	46	-	92	25	20	23	4	023	●
M36X3	ISO2X(6HX)	33	33.13	SM036SUEEXJ	2.5P	200	-	52	-	102	28	22	25	4	023	●
M39X3	ISO2X(6HX)	36	36.13	SM039SUEEXJ	2.5P	200	-	52	-	102	32	24	27	4	023	●
M42X3	ISO2X(6HX)	39	39.13	SM042SUEEXJ	2.5P	200	-	59	-	102	32	24	27	4	023	●
M48X3	ISO2X(6HX)	45	45.13	SM048SUEEXJ	2.5P	225	-	49	-	115	36	29	32	4	023	●

Intro

SP
DIN

SL

PO

ST

ROLL

CARBIDE

LONG

HAND TAPS

EG (STI)

SPECIAL THREADS, GAUGES

THREAD MILLS

DIES

CENTER DRILLS

Technical info

Spiral Fluted Taps

Intro

UNC	TCTR (tolerance)	 Hole Ø (mm)	Hole Ø (mm)	Code	THCHT (chamfer)	LF (mm)	LT (mm)	THL (mm)	LU (mm)	LS (mm)	DCON (mm)	K (mm)	LK (mm)	NOF	Type	Stock
DIN 376																
1 -8UNC	2BX	22.3	22.45	SGU16XYEEXJ	2.5P	160	-	37	-	82	18	14.5	17	4	023	●
1 1/8-7UNC	2BX	25	25.17	SGU18YYEEXJ	2.5P	180	-	44	-	92	22	18	21	4	023	●
1 1/4-7UNC	2BX	28.2	28.35	SGU20YYEEXJ	2.5P	180	-	49	-	92	22	18	21	4	023	●
1 3/8-6UNC	2BX	30.8	30.92	SGU22ZYEEXJ	2.5P	200	-	55	-	102	28	22	25	4	023	●
1 1/2-6UNC	2BX	34	34.1	SGU24ZYEEXJ	2.5P	200	-	59	-	102	32	24	27	4	023	●
1 3/4-5UNC	2BX	39.5	39.61	SGU280YEEXJ	2.5P	220	-	65	-	112	36	29	32	4	023	●
2 -4.5UNC	2BX	45.2	45.37	SGU329YEEXJ	2.5P	250	-	73	-	128	40	32	35	4	023	●

SP

DIN

SL

PO

ST

ROLL

CARBIDE

LONG

HAND
TAPS

EG (STI)

SPECIAL
THREADS,
GAUGES

THREAD
MILLS

DIES

CENTER
DRILLS

Technical
info

UNF	TCTR (tolerance)	 Hole Ø (mm)	Hole Ø (mm)	Code	THCHT (chamfer)	LF (mm)	LT (mm)	THL (mm)	LU (mm)	LS (mm)	DCON (mm)	K (mm)	LK (mm)	NOF	Type	Stock
DIN 374																
1 -12UNF	2BX	23.3	23.46	SMU16SYEEXJ	2.5P	140	-	27	-	71	18	14.5	17	4	023	●
1 1/8-12UNF	2BX	26.5	26.63	SMU18SYEEXJ	2.5P	150	-	27	-	77	22	18	21	4	023	●
1 1/4-12UNF	2BX	29.6	29.81	SMU20SYEEXJ	2.5P	150	-	27	-	77	22	18	21	4	023	●
1 3/8-12UNF	2BX	32.8	32.98	SMU22SYEEXJ	2.5P	170	-	29	-	87	28	22	25	4	023	●
1 1/2-12UNF	2BX	36	36.16	SMU24SYEEXJ	2.5P	170	-	29	-	87	32	24	27	4	023	●

8UN	TCTR (tolerance)	 Hole Ø (mm)	Hole Ø (mm)	Code	THCHT (chamfer)	LF (mm)	LT (mm)	THL (mm)	LU (mm)	LS (mm)	DCON (mm)	K (mm)	LK (mm)	NOF	Type	Stock
DIN 374																
1 1/8-8UN	2BX	25.5	25.62	SMU18XYEEXJ	2.5P	180	-	44	-	92	22	18	21	4	023	●
1 1/4-8UN	2BX	28.5	28.8	SMU20XYEEXJ	2.5P	180	-	49	-	92	22	18	21	4	023	●
1 3/8-8UN	2BX	31.8	31.97	SMU22XYEEXJ	2.5P	200	-	55	-	102	28	22	25	4	023	●
1 1/2-8UN	2BX	35	35.15	SMU24XYEEXJ	2.5P	200	-	59	-	102	32	24	27	4	023	●
1 3/4-8UN	2BX	41.3	41.5	SMU28XYEEXJ	2.5P	200	-	49	-	102	36	29	32	4	023	●
2 -8UN	2BX	47.8	47.85	SMU32XYEEXJ	2.5P	225	-	49	-	115	40	32	35	4	023	●

12UN	TCTR (tolerance)	 Hole Ø (mm)	Hole Ø (mm)	Code	THCHT (chamfer)	LF (mm)	LT (mm)	THL (mm)	LU (mm)	LS (mm)	DCON (mm)	K (mm)	LK (mm)	NOF	Type	Stock
DIN 374																
1 3/4-12UN	2BX	42.3	42.51	SMU28SYEEXJ	2.5P	180	-	31	-	92	36	29	32	4	023	●

Intro

SP

DIN

SL

PO

ST

ROLL

CARBIDE

LONG

HAND
TAPS

EG (STI)

SPECIAL
THREADS,
GAUGES

THREAD
MILLS

DIES

CENTER
DRILLS

Technical
info

Intro

MHSP



SP

Z-PRO Series

Spiral Fluted Taps for Carbon Steel of Medium Hardness, Coated

DIN

SL



PO

Recommended Tapping Speeds Depending On Materials

ISO	Vc (m/min)
P2	10÷30 ★
P3	10÷25 ★
P4	10÷20 ★
P5	10÷15 ☆

★ 1st choice ☆ suitable

ST

ROLL

FEATURES

Z-PRO Series for Medium Hardness workpiece materials. Most suitable for high carbon steel (C48 ÷ C55) and alloy steel 20 ÷ 30HRC. Long life thanks to HSSCo substrate and special coating. High spiral design allows smooth chip ejection at middle-high cutting speed.

CARBIDE

Product Features

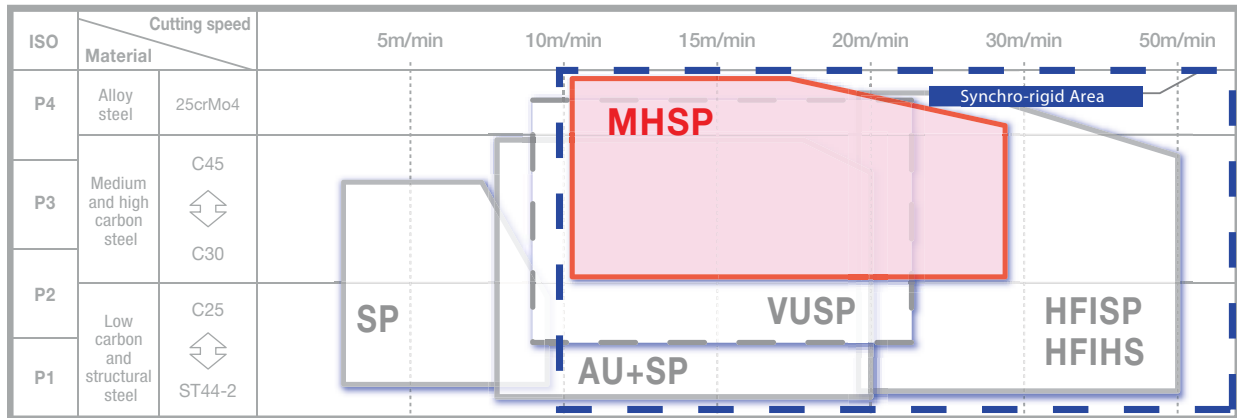

LONG

HAND TAPS

EG (STI)

Process Data

Work-material	42CrMo4 - 1.7225 (35HRC)
Threading speed	12 mm
Tapping speed	15 m/min
Machine	Vertical machining center
Lubricant	Water soluble oil

After 550 holes



SPECIAL THREADS, GAUGES

THREAD MILLS

DIES

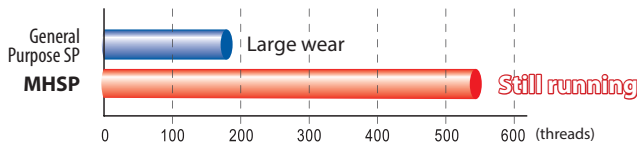

CENTER DRILLS

Technical info

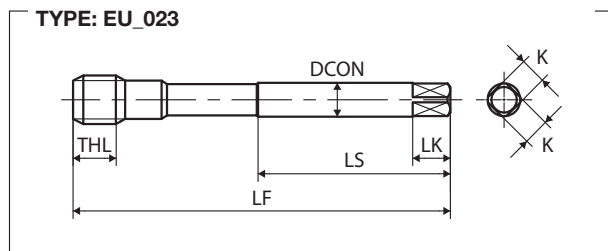
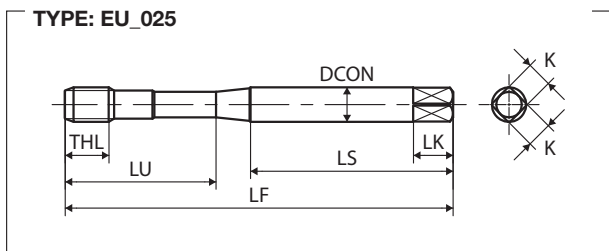

M	TCTR (tolerance)	\varnothing (mm)	Hole \varnothing (mm)	Code	THCHT (chamfer)	LF (mm)	LT (mm)	THL (mm)	LU (mm)	LS (mm)	DCON (mm)	K (mm)	LK (mm)	NOF	Type	Stock
DIN 371																
M8X1.25	ISO2X(6HX)	6.8	6.85	SD8.0NBOCLJ	2.5P	90	-	19	-	47	8	6.2	9	3	025	●
M10X1.5	ISO2X(6HX)	8.5	8.6	SD0100BOCLJ	2.5P	100	-	23	-	52.5	10	8	11	3	025	●
M	TCTR (tolerance)	\varnothing (mm)	Hole \varnothing (mm)	Code	THCHT (chamfer)	LF (mm)	LT (mm)	THL (mm)	LU (mm)	LS (mm)	DCON (mm)	K (mm)	LK (mm)	NOF	Type	Stock
DIN 376																
M12X1.75	ISO2X(6HX)	10.3	10.36	SG012PBOCLJ	2.5P	110	-	26	-	56	9	7	10	4	023	●
M14X2	ISO2X(6HX)	12	12.12	SG014QBOCLJ	2.5P	110	-	26	-	56	11	9	12	4	023	●
M16X2	ISO2X(6HX)	14	14.12	SG016QBOCLJ	2.5P	110	-	26	-	56	12	9	12	4	023	●
MF	TCTR (tolerance)	\varnothing (mm)	Hole \varnothing (mm)	Code	THCHT (chamfer)	LF (mm)	LT (mm)	THL (mm)	LU (mm)	LS (mm)	DCON (mm)	K (mm)	LK (mm)	NOF	Type	Stock
DIN 374																
M10X1.25	ISO2X(6HX)	8.8	8.85	SM010NBOCLJ	2.5P	100	-	23	-	51	7	5.5	8	3	023	●
M10X1	ISO2X(6HX)	9	9.09	SM010MBOCLJ	2.5P	90	-	19	-	46	7	5.5	8	3	023	●
M12X1.5	ISO2X(6HX)	10.5	10.6	SM0120BOCLJ	2.5P	100	-	21	-	51	9	7	10	4	023	●
M12X1.25	ISO2X(6HX)	10.8	10.85	SM012NBOCLJ	2.5P	100	-	21	-	51	9	7	10	4	023	●
M14X1.5	ISO2X(6HX)	12.5	12.6	SM0140BOCLJ	2.5P	100	-	21	-	51	11	9	12	4	023	●
M16X1.5	ISO2X(6HX)	14.5	14.6	SM0160BOCLJ	2.5P	100	-	21	-	51	12	9	12	4	023	●

Intro

SP
DIN

SL

PO

ST

ROLL

CARBIDE

LONG

HAND
TAPS

EG (STI)

SPECIAL
THREADS,
GAUGES

THREAD
MILLS

DIES

CENTER
DRILLS

Technical
info

Intro

SP

GP General Purpose Series

Spiral Fluted Taps

SP

DIN

SL



PO

Recommended Tapping Speeds Depending On Materials

ISO	Vc (m/min)	ISO	Vc (m/min)
P1	5±10 ☆	N1	5±10 ☆
P2	5±10 ★	N2	5±10 ☆
P3	5±10 ☆	N3	5±10 ☆
P4	5±8 ☆	N4	5±10 ☆

★ 1st choice ☆ suitable

ST

ROLL

CARBIDE

LONG

HAND TAPS

EG (STI)

SPECIAL THREADS, GAUGES

THREAD MILLS

DIES

CENTER DRILLS

Technical info



FEATURES

General purpose for blind hole application.

For tapping steel at medium-low cutting speed, also suitable for non-ferrous materials.

TYPE: EU_140

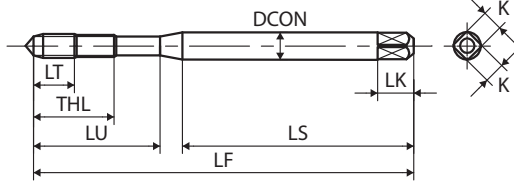

TYPE: EU_141

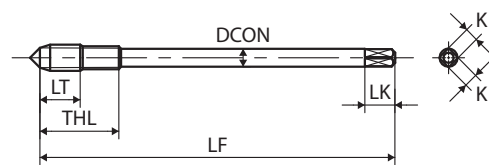

TYPE: EU_025

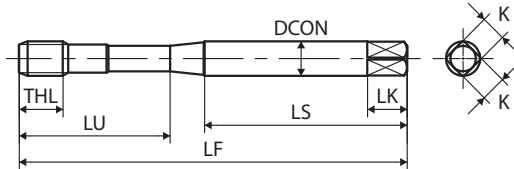

TYPE: EU_023

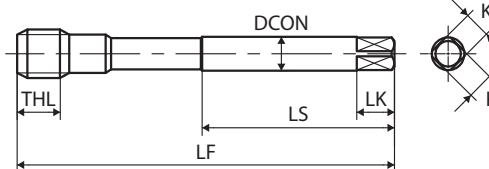

M	TCTR (tolerance)	\varnothing (mm)	Hole \varnothing (mm)	Code	THCHT (chamfer)	LF (mm)	LT (mm)	THL (mm)	LU (mm)	LS (mm)	DCON (mm)	K (mm)	LK (mm)	NOF	Type	Stock
DIN 371																
M2X0.4	ISO2(6H)	1.6	1.65	SD2.0EANEB	2.5P	45	4	8	-	32	2.8	2.1	5	2	140	●
M2.2X0.45	ISO2(6H)	1.75	1.81	SD2.2FANEB	2.5P	45	4	9	-	32	2.8	2.1	5	2	140	○
M2.3X0.4	ISO2(6H)	1.9	1.95	SD2.3EANEB	2.5P	45	4	9	-	32	2.8	2.1	5	2	140	○
M2.5X0.45	ISO2(6H)	2.1	2.11	SD2.5FANEB	2.5P	50	4	8	15	33	2.8	2.1	5	2	140	●
M2.6X0.45	ISO2(6H)	2.2	2.21	SD2.6FANEB	2.5P	50	4	8	15	33	2.8	2.1	5	2	140	●
M3X0.5	ISO2(6H)	2.5	2.56	SD3.0GANEB	2.5P	56	5	9	18	34	3.5	2.7	6	3	140	●
	ISO3(6G)	2.5	2.56	SD3.0GMNEB	2.5P	56	5	9	18	34	3.5	2.7	6	3	140	●
	ISO2(6H)+100	2.5	2.56	96403.0+100	2.5P	56	5	9	18	34	3.5	2.7	6	3	140	●
M3.5X0.6	ISO2(6H)	2.9	2.97	SD3.5HANEB	2.5P	56	7	11	20	32	4	3	6	3	140	●
M4X0.7	ISO2(6H)	3.3	3.38	SD4.0IANEB	2.5P	63	7	13	21	38	4.5	3.4	6	3	140	●
	ISO3(6G)	3.3	3.38	SD4.0IMNEB	2.5P	63	7	13	21	38	4.5	3.4	6	3	140	●
	ISO2(6H)+100	3.3	3.38	96404.0+100	2.5P	63	7	13	21	371	4.5	3.4	6	3	140	●
M5X0.8	ISO2(6H)	4.2	4.28	SD5.0KANEB	2.5P	70	9	14	25	39	6	4.9	8	3	140	●
	ISO3(6G)	4.2	4.28	SD5.0KMNEB	2.5P	70	9	14	25	39	6	4.9	8	3	140	●
	ISO2(6H)+100	4.2	4.28	96405.0+100	2.5P	70	9	14	25	39	6	4.9	8	3	140	●
M6X1	ISO2(6H)	5	5.09	SD6.0MANEB	2.5P	80	11	15	30	45	6	4.9	8	3	140	●
	ISO3(6G)	5	5.09	SD6.0MMNEB	2.5P	80	11	15	30	45	6	4.9	8	3	140	●
	ISO2(6H)+50	5	5.09	N96406.0+50	2.5P	80	11	15	30	45	6	4.9	8	3	140	●
	ISO2(6H)+100	5	5.09	96406.0+100	2.5P	80	11	15	30	45	6	4.9	8	3	140	●
M7X1	ISO2(6H)	6	6.09	SD7.0MANEB	2.5P	80	-	11	30	45	7	5.5	8	3	025	●
M8X1.25	ISO2(6H)	6.8	6.85	SD8.0ANEB	2.5P	90	-	12	35	47	8	6.2	9	3	025	●
	ISO3(6G)	6.8	6.85	SD8.0NMNEB	2.5P	90	-	12	35	47	8	6.2	9	3	025	●
	ISO2(6H)+50	6.8	6.85	N96408.0+50	2.5P	90	-	12	35	47	8	6.2	9	3	025	●
	ISO2(6H)+100	6.8	6.85	96408.0+100	2.5P	90	-	12	35	47	8	6.2	9	3	025	●
M9X1.25	ISO2(6H)	7.8	7.85	SD9.0ANEB	2.5P	90	-	12	35	48	9	7	10	3	025	●
M10X1.5	ISO2(6H)	8.5	8.6	SD0100ANEB	2.5P	100	-	13	39	52	10	8	11	3	025	●
	ISO3(6G)	8.5	8.6	SD0100MNEB	2.5P	100	-	13	39	52	10	8	11	3	025	●
	ISO2(6H)+50	8.5	8.6	N9640010+50	2.5P	100	-	13	39	52	10	8	11	3	025	●
	ISO2(6H)+100	8.5	8.6	9640010+100	2.5P	100	-	13	39	52	10	8	11	3	025	●
DIN 376																
M4X0.7	ISO2(6H)	3.3	3.38	SG4.0IANEB	2.5P	63	7	13	-	-	2.8	2.1	5	3	141	●
M5X0.8	ISO2(6H)	4.2	4.28	SG5.0KANEB	2.5P	70	9	14	-	-	3.5	2.7	6	3	141	●
M6X1	ISO2(6H)	5	5.09	SG6.0MANEB	2.5P	80	11	15	-	-	4.5	3.4	6	3	141	●
M8X1.25	ISO2(6H)	6.8	6.85	SG8.0ANEB	2.5P	90	-	12	-	46	6	4.9	8	3	023	●
M10X1.5	ISO2(6H)	8.5	8.6	SG0100ANEB	2.5P	100	-	13	-	51	7	5.5	8	3	023	●
M11X1.5	ISO2(6H)	9.5	9.6	SG0110ANEB	2.5P	100	-	13	-	51	8	6.2	9	3	023	●
M12X1.75	ISO2(6H)	10.3	10.36	SG012PANEB	2.5P	110	-	15	-	56	9	7	10	3	023	●
	ISO3(6G)	10.3	10.36	SG012PMNEB	2.5P	110	-	15	-	56	9	7	10	3	023	●
	ISO2(6H)+100	10.3	10.36	9740012+100	2.5P	110	-	15	-	56	9	7	10	3	023	●
M14X2	ISO2(6H)	12	12.12	SG014QANEB	2.5P	110	-	18	-	56	11	9	12	3	023	●
	ISO3(6G)	12	12.12	SG014QMNEB	2.5P	110	-	18	-	56	11	9	12	3	023	○
M16X2	ISO2(6H)	14	14.12	SG016QANEB	2.5P	110	-	18	-	56	12	9	12	3	023	●
	ISO3(6G)	14	14.12	SG016QMNEB	2.5P	110	-	18	-	56	12	9	12	3	023	●
M18X2.5	ISO2(6H)	15.5	15.63	SG018RANEB	2.5P	125	-	20	-	64	14	11	14	4	023	●
M20X2.5	ISO2(6H)	17.5	17.63	SG020RANEB	2.5P	140	-	20	-	71	16	12	15	4	023	●

Intro

SP

DIN

SL

PO

ST

ROLL

CARBIDE

LONG

HAND
TAPS

EG (STI)

SPECIAL
THREADS,
GAUGESTHREAD
MILLS

DIES

CENTER
DRILLSTechnical
info

Spiral Fluted Taps

Intro

SP
DIN

SL

PO

ST

ROLL

CARBIDE

LONG

HAND
TAPS

EG (STI)

SPECIAL
THREADS,
GAUGES

THREAD
MILLS

DIES

CENTER
DRILLS

M	TCTR (tolerance)	\varnothing (mm)	Hole \varnothing (mm)	Code	THCHT (chamfer)	LF (mm)	LT (mm)	THL (mm)	LU (mm)	LS (mm)	DCON (mm)	K (mm)	LK (mm)	NOF	Type	Stock
DIN 376																
M22X2.5	ISO2(6H)	19.5	19.63	SG022RANEB	2.5P	140	-	20	-	71	18	14.5	17	4	023	●
M24X3	ISO2(6H)	21	21.13	SG024SANEB	2.5P	160	-	25	-	82	18	14.5	17	4	023	●
M27X3	ISO2(6H)	24	24.13	SG027SANEB	2.5P	160	-	25	-	82	20	16	19	4	023	●
M30X3.5	ISO2(6H)	26.5	26.63	SG030TANEB	2.5P	180	-	30	-	92	22	18	21	4	023	●
M33X3.5	ISO2(6H)	29.5	29.63	SG033TANEB	2.5P	180	-	30	-	92	25	20	23	4	023	●
M36X4	ISO2(6H)	32	32.12	SG036UANEB	2.5P	200	-	40	-	102	28	22	25	4	023	●
M39X4	ISO2(6H)	35	35.12	SG039UANEB	2.5P	200	-	40	-	102	32	24	27	4	023	●
M42X4.5	ISO2(6H)	37.5	37.63	SG042VANEB	2.5P	200	-	40	-	102	32	24	27	4	023	●
M45X4.5	ISO2(6H)	40.5	40.63	SG045VANEB	2.5P	220	-	45	-	112	36	29	32	4	023	●
M48X5	ISO2(6H)	43	43.12	SG048WANEB	2.5P	250	-	45	-	128	36	29	32	4	023	●
MF	TCTR (tolerance)	\varnothing (mm)	Hole \varnothing (mm)	Code	THCHT (chamfer)	LF (mm)	LT (mm)	THL (mm)	LU (mm)	LS (mm)	DCON (mm)	K (mm)	LK (mm)	NOF	Type	Stock
DIN 374																
M4X0.5	ISO2(6H)	3.5	3.56	SM4.0GANEB	2.5P	63	9	9	-	-	2.8	2.1	5	3	141	○
M5X0.5	ISO2(6H)	4.5	4.56	SM5.0GANEB	2.5P	70	11	11	-	-	3.5	2.7	6	3	141	○
M6X0.75	ISO2(6H)	5.3	5.33	SM6.0JANEB	2.5P	80	13	13	-	-	4.5	3.4	6	3	141	○
M6X0.5	ISO2(6H)	5.5	5.56	SM6.0GANEB	2.5P	80	13	13	-	-	4.5	3.4	6	3	141	○
M7X0.75	ISO2(6H)	6.3	6.33	SM7.0JANEB	2.5P	80	-	8	-	41	5.5	4.3	7	3	023	○
M7X0.5	ISO2(6H)	6.5	6.56	SM7.0GANEB	2.5P	80	-	8	-	41	5.5	4.3	7	3	023	○
M8X1	ISO2(6H)	7	7.09	SM8.0MANEB	2.5P	90	-	12	-	46	6	4.9	8	3	023	●
M8X0.75	ISO2(6H)	7.3	7.33	SM8.0JANEB	2.5P	80	-	12	-	41	6	4.9	8	3	023	●
M8X0.5	ISO2(6H)	7.5	7.56	SM8.0GANEB	2.5P	80	-	12	-	41	6	4.9	8	3	023	○
M9X1	ISO2(6H)	8	8.09	SM9.0MANEB	2.5P	90	-	12	-	46	7	5.5	8	3	023	○
M10X1.25	ISO2(6H)	8.8	8.85	SM010NANEB	2.5P	100	-	13	-	51	7	5.5	8	3	023	●
M10X1	ISO2(6H)	9	9.09	SM010MANEB	2.5P	90	-	13	-	46	7	5.5	8	3	023	●
M10X0.75	ISO2(6H)	9.3	9.33	SM010JANEB	2.5P	90	-	13	-	46	7	5.5	8	3	023	●
M12X1.5	ISO2(6H)	10.5	10.6	SM0120ANEB	2.5P	100	-	15	-	51	9	7	10	3	023	●
M12X1.25	ISO2(6H)	10.8	10.85	SM012NANEB	2.5P	100	-	15	-	51	9	7	10	3	023	●
M12X1	ISO2(6H)	11	11.09	SM012MANEB	2.5P	100	-	15	-	51	9	7	10	3	023	●
M14X1.5	ISO2(6H)	12.5	12.6	SM0140ANEB	2.5P	100	-	14	-	51	11	9	12	3	023	●
M14X1.25	ISO2(6H)	12.8	12.85	SM014NANEB	2.5P	100	-	14	-	51	11	9	12	3	023	●
M14X1	ISO2(6H)	13	13.09	SM014MANEB	2.5P	100	-	14	-	51	11	9	12	3	023	●
M16X1.5	ISO2(6H)	14.5	14.6	SM0160ANEB	2.5P	100	-	14	-	51	12	9	12	3	023	●
M16X1	ISO2(6H)	15	15.09	SM016MANEB	2.5P	100	-	14	-	51	12	9	12	3	023	●
M18X2	ISO2(6H)	16	16.12	SM018QANEB	2.5P	125	-	18	-	64	14	11	14	4	023	●
M18X1.5	ISO2(6H)	16.5	16.6	SM0180ANEB	2.5P	110	-	14	-	56	14	11	14	4	023	●
M18X1	ISO2(6H)	17	17.09	SM018MANEB	2.5P	110	-	14	-	56	14	11	14	4	023	●
M20X2	ISO2(6H)	18	18.12	SM020QANEB	2.5P	140	-	18	-	71	16	12	15	4	023	●
M20X1.5	ISO2(6H)	18.5	18.6	SM0200ANEB	2.5P	125	-	14	-	64	16	12	15	4	023	●
M20X1	ISO2(6H)	19	19.09	SM020MANEB	2.5P	125	-	14	-	64	16	12	15	4	023	●
M22X2	ISO2(6H)	20	20.12	SM022QANEB	2.5P	140	-	18	-	71	18	14.5	17	4	023	●
M22X1.5	ISO2(6H)	20.5	20.6	SM0220ANEB	2.5P	125	-	14	-	64	18	14.5	17	4	023	●
M22X1	ISO2(6H)	21	21.09	SM022MANEB	2.5P	125	-	14	-	64	18	14.5	17	4	023	●
M24X2	ISO2(6H)	22	22.12	SM024QANEB	2.5P	140	-	18	-	71	18	14.5	17	4	023	●
M24X1.5	ISO2(6H)	22.5	22.6	SM0240ANEB	2.5P	140	-	18	-	71	18	14.5	17	4	023	●
M24X1	ISO2(6H)	23	23.09	SM024MANEB	2.5P	140	-	18	-	71	18	14.5	17	4	023	●
M25X1.5	ISO2(6H)	23.5	23.6	SM0250ANEB	2.5P	140	-	18	-	71	18	14.5	17	4	023	●

Technical
info

MF	TCTR (tolerance)	∅ (mm)	Hole ∅ (mm)	Code	THCHT (chamfer)	LF (mm)	LT (mm)	THL (mm)	LU (mm)	LS (mm)	DCON (mm)	K (mm)	LK (mm)	NOF	Type	Stock
DIN 374																
M26X1.5	IS02(6H)	24.5	24.6	SM0260ANEB	2.5P	140	-	18	-	71	18	14.5	17	4	023	●
M27X2	IS02(6H)	25	25.12	SM0270ANEB	2.5P	140	-	20	-	71	20	16	19	4	023	●
M27X1.5	IS02(6H)	25.5	25.6	SM0270ANEB	2.5P	140	-	20	-	71	20	16	19	4	023	●
M27X1	IS02(6H)	26	26.09	SM027MANEB	2.5P	140	-	20	-	71	20	16	19	4	023	○
M28X2	IS02(6H)	26	26.12	SM0280ANEB	2.5P	140	-	20	-	71	20	16	19	4	023	●
M28X1.5	IS02(6H)	26.5	26.6	SM0280ANEB	2.5P	140	-	20	-	71	20	16	19	4	023	●
M28X1	IS02(6H)	27	27.09	SM028MANEB	2.5P	140	-	20	-	71	20	16	19	4	023	○
M30X2	IS02(6H)	28	28.12	SM0300ANEB	2.5P	150	-	20	-	77	22	18	21	4	023	●
M30X1.5	IS02(6H)	28.5	28.6	SM0300ANEB	2.5P	150	-	20	-	77	22	18	21	4	023	●
M30X1	IS02(6H)	29	29.09	SM030MANEB	2.5P	150	-	20	-	77	22	18	21	4	023	●
M32X2	IS02(6H)	30	30.12	SM0320ANEB	2.5P	150	-	20	-	77	22	18	21	4	023	●
M32X1.5	IS02(6H)	30.5	30.6	SM0320ANEB	2.5P	150	-	20	-	77	22	18	21	4	023	●
M32X1	IS02(6H)	31	31.09	SM032MANEB	2.5P	150	-	20	-	77	22	18	21	4	023	○
M33X2	IS02(6H)	31	31.12	SM0330ANEB	2.5P	160	-	20	-	82	25	20	23	4	023	●
M33X1.5	IS02(6H)	31.5	31.6	SM0330ANEB	2.5P	160	-	20	-	82	25	20	23	4	023	●
M33X1	IS02(6H)	32	32.09	SM033MANEB	2.5P	160	-	20	-	82	25	20	23	4	023	○
M35X1.5	IS02(6H)	33.5	33.6	SM0350ANEB	2.5P	170	-	20	-	87	28	22	25	4	023	○
M36X3	IS02(6H)	33	33.13	SM036SANEB	2.5P	200	-	30	-	102	28	22	25	4	023	●
M36X2	IS02(6H)	34	34.12	SM036QANEB	2.5P	170	-	20	-	87	28	22	25	4	023	●
M36X1.5	IS02(6H)	34.5	34.6	SM0360ANEB	2.5P	170	-	20	-	87	28	22	25	4	023	●
M36X1	IS02(6H)	35	35.09	SM036MANEB	2.5P	170	-	20	-	87	28	22	25	4	023	○
M39X2	IS02(6H)	37	37.12	SM039QANEB	2.5P	170	-	20	-	87	32	24	27	4	023	○
M39X1.5	IS02(6H)	37.5	37.6	SM0390ANEB	2.5P	170	-	20	-	87	32	24	27	4	023	○
M39X1	IS02(6H)	38	38.09	SM039MANEB	2.5P	170	-	20	-	87	32	24	27	4	023	○
M42X2	IS02(6H)	40	40.12	SM042QANEB	2.5P	170	-	20	-	87	32	24	27	4	023	○
M42X1.5	IS02(6H)	40.5	40.6	SM0420ANEB	2.5P	170	-	20	-	87	32	24	27	4	023	○
M42X1	IS02(6H)	41	41.09	SM042MANEB	2.5P	170	-	20	-	87	32	24	27	4	023	○
M45X3	IS02(6H)	42	42.13	SM045SANEB	2.5P	200	-	40	-	102	36	29	32	4	023	○
M45X2	IS02(6H)	43	43.12	SM045QANEB	2.5P	180	-	25	-	92	36	29	32	4	023	○
M45X1.5	IS02(6H)	43.5	43.6	SM0450ANEB	2.5P	180	-	25	-	92	36	29	32	4	023	○
M45X1	IS02(6H)	44	44.09	SM045MANEB	2.5P	180	-	25	-	92	36	29	32	4	023	○
M48X3	IS02(6H)	45	45.13	SM048SANEB	2.5P	225	-	40	-	115	36	29	32	4	023	○
M48X2	IS02(6H)	46	46.12	SM048QANEB	2.5P	190	-	25	-	97	36	29	32	4	023	○
M48X1.5	IS02(6H)	46.5	46.6	SM0480ANEB	2.5P	190	-	25	-	97	36	29	32	4	023	○
M48X1	IS02(6H)	47	47.09	SM048MANEB	2.5P	190	-	25	-	97	36	29	32	4	023	○
UNC	TCTR (tolerance)	∅ (mm)	Hole ∅ (mm)	Code	THCHT (chamfer)	LF (mm)	LT (mm)	THL (mm)	LU (mm)	LS (mm)	DCON (mm)	K (mm)	LK (mm)	NOF	Type	Stock
DIN 371																
No.4-40UNC	2B	2.3	2.33	SDUN4HXNEB	2.5P	56	5	9	18	34	3.5	2.7	6	2	140	●
No.5-40UNC	2B	2.6	2.64	SDUN5HXNEB	2.5P	56	5	11	18	34	3.5	2.7	6	2	140	○
No.6-32UNC	2B	2.8	2.83	SDUN6JXNEB	2.5P	56	7	11	19	32	4	3	6	3	140	●
No.8-32UNC	2B	3.4	3.47	SDUN8JXNEB	2.5P	63	7	13	21	38	4.5	3.4	6	3	140	●
No.10-24UNC	2B	3.89	3.9	SDUNAMXNEB	2.5P	70	9	14	24	39	6	4.9	8	3	140	●
No.12-24UNC	2B	4.5	4.53	SDUNCMXNEB	2.5P	80	9	15	28	45	6	4.9	8	3	140	○
1/4-20UNC	2B	5.1	5.19	SDU04NXNEB	2.5P	80	11	15	30	42	7	5.5	8	3	140	●
5/16-18UNC	2B	6.6	6.65	SDU05OXNEB	2.5P	90	-	12	35	47	8	6.2	9	3	025	●
3/8-16UNC	2B	8	8.07	SDU06PXNEB	2.5P	100	-	13	39	54	9	7	10	3	025	●

Intro

SP

DIN

SL

PO

ST

ROLL

CARBIDE

LONG

HAND TAPS

EG (STI)

SPECIAL THREADS, GAUGES

THREAD MILLS

DIES

CENTER DRILLS

Technical info

Spiral Fluted Taps

Intro

	UNC	TCTR (tolerance)	 Hole Ø (mm)	Hole Ø (mm)	Code	THCHT (chamfer)	LF (mm)	LT (mm)	THL (mm)	LU (mm)	LS (mm)	DCON (mm)	K (mm)	LK (mm)	NOF	Type	Stock	
	DIN 376																	
SP	7/16-14UNC	2B	9.4	9.45	SGU07QXNEB	2.5P	100	-	13	-	51	8	6.2	9	3	023	●	
	1/2-13UNC	2B	10.9	10.91	SGU08RXNEB	2.5P	110	-	15	-	56	9	7	10	3	023	●	
DIN	9/16-12UNC	2B	12.2	12.33	SGU09SXNEB	2.5P	110	-	18	-	56	11	9	12	3	023	●	
	5/8-11UNC	2B	13.6	13.75	SGU10UXNEB	2.5P	110	-	18	-	56	12	9	12	3	023	●	
SL	3/4-10UNC	2B	16.6	16.7	SGU12VXNEB	2.5P	125	-	20	-	64	14	11	14	4	023	●	
	7/8-9UNC	2B	19.6	19.61	SGU14WXNEB	2.5P	140	-	20	-	71	18	14.5	17	4	023	●	
	1-8UNC	2B	22.3	22.45	SGU16XXNEB	2.5P	160	-	25	-	82	18	14.5	17	4	023	●	

PO

	UNF	TCTR (tolerance)	 Hole Ø (mm)	Hole Ø (mm)	Code	THCHT (chamfer)	LF (mm)	LT (mm)	THL (mm)	LU (mm)	LS (mm)	DCON (mm)	K (mm)	LK (mm)	NOF	Type	Stock	
	DIN 371																	
ST	No.4-48UNF	2B	2.4	2.41	SDUN4FXNEB	2.5P	56	5	9	18	34	3.5	2.7	6	2	140	○	
	No.5-44UNF	2B	2.7	2.69	SDUN5GXNEB	2.5P	56	5	11	18	34	3.5	2.7	6	2	140	○	
ROLL	No.6-40UNF	2B	2.9	2.97	SDUN6HXNEB	2.5P	56	7	11	19	32	4	3	6	3	140	●	
	No.8-36UNF	2B	3.5	3.55	SDUN8IXNEB	2.5P	63	7	13	21	38	4.5	3.4	6	3	140	○	
CARBIDE	No.10-32UNF	2B	4.1	4.12	SDUNAJXNEB	2.5P	70	9	14	24	39	6	4.9	8	3	140	●	
	No.12-28UNF	2B	4.6	4.67	SDUNCKXNEB	2.5P	80	9	15	28	45	6	4.9	8	3	140	○	
	1/4-28UNF	2B	5.5	5.53	SDU04KXNEB	2.5P	80	11	15	30	42	7	5.5	8	3	140	●	

CARBIDE

	UNF	TCTR (tolerance)	 Hole Ø (mm)	Hole Ø (mm)	Code	THCHT (chamfer)	LF (mm)	LT (mm)	THL (mm)	LU (mm)	LS (mm)	DCON (mm)	K (mm)	LK (mm)	NOF	Type	Stock	
	DIN 374																	
LONG	5/16-24UNF	2B	6.9	6.97	SMU05MXNEB	2.5P	90	-	12	-	46	6	4.9	8	3	023	●	
	3/8-24UNF	2B	8.5	8.57	SMU06MXNEB	2.5P	100	-	13	-	51	7	5.5	8	3	023	●	
HAND TAPS	7/16-20UNF	2B	9.9	9.96	SMU07NXNEB	2.5P	100	-	13	-	51	8	6.2	9	3	023	●	
	1/2-20UNF	2B	11.5	11.54	SMU08NXNEB	2.5P	100	-	15	-	51	9	7	10	3	023	●	
EG (STI)	9/16-18UNF	2B	12.9	13	SMU09OXNEB	2.5P	100	-	14	-	51	11	9	12	3	023	●	
	5/8-18UNF	2B	14.5	14.6	SMU10OXNEB	2.5P	100	-	14	-	51	12	9	12	3	023	●	
SPECIAL THREADS, GAUGES	3/4-16UNF	2B	17.5	17.59	SMU12PXNEB	2.5P	110	-	14	-	56	14	11	14	4	023	●	
	7/8-14UNF	2B	20.5	20.57	SMU14QXNEB	2.5P	125	-	20	-	64	18	14.5	17	4	023	●	
	1-12UNF	2B	23.3	23.46	SMU16SXNEB	2.5P	140	-	18	-	71	18	14.5	17	4	023	●	

EG (STI)

	G(BSP)	TCTR (tolerance)	 Hole Ø (mm)	Hole Ø (mm)	Code	THCHT (chamfer)	Basic major Ø (mm)	LF (mm)	THL (mm)	LS (mm)	DCON (mm)	K (mm)	LK (mm)	NOF	Type	Stock		
	DIN 5156																	
THREAD MILLS	1/16-28	-	6.75	6.77	SVG0010NEB	2.5P	7723	90	12	46	6	4.9	8	3	023	○		
	1/8-28	-	8.75	8.78	SVG0020NEB	2.5P	9.728	90	12	46	7	5.5	8	3	023	●		
DIES	1/4-19	-	11.75	11.78	SVG0040NEB	2.5P	13.157	100	14	51	11	9	12	3	023	●		
	3/8-19	-	15.25	15.28	SVG0060NEB	2.5P	22911	100	14	51	12	9	12	3	023	●		
CENTER DRILLS	1/2-14	-	19	19.04	SVG0080NEB	2.5P	20.955	125	18	64	16	12	15	4	023	●		
	5/8-14	-	21	21	SVG0100NEB	2.5P	22911	125	18	64	18	14.5	17	4	023	○		
DIES	3/4-14	-	24.5	24.52	SVG0120NEB	2.5P	26.441	140	20	71	20	16	19	4	023	●		
	7/8-14	-	28.25	28.28	SVG0140NEB	2.5P	30201	150	20	77	22	18	21	4	023	○		
DIES	1-11	-	30.75	30.77	SVG0160NEB	2.5P	33.249	160	20	82	25	20	23	4	023	●		
	1 1/8-11	-	35.3	35.42	SVG0180NEB	2.5P	37897	170	20	87	28	22	25	4	023	○		
DIES	1 1/4-11	-	39.3	39.43	SVG0200NEB	2.5P	41.910	170	20	87	32	24	27	4	023	●		
	1 1/2-11	-	45.25	45.33	SVG0240NEB	2.5P	47.803	190	25	97	36	29	32	4	023	●		

CENTER DRILLS

Technical info

Intro

SP

DIN

SL

PO

ST

ROLL

CARBIDE

LONG

HAND
TAPS

EG (STI)

SPECIAL
THREADS,
GAUGES

THREAD
MILLS

DIES

CENTER
DRILLS

Technical
info

Intro

SP-BLF

GP General Purpose Series

Spiral Fluted Taps, Deep Hole Use

SP

DIN

SL



PO

Recommended Tapping Speeds Depending On Materials

ISO	Vc (m/min)	ISO	Vc (m/min)
P1	5÷10 ☆	N1	5÷10 ☆
P2	5÷10 ★	N2	5÷10 ☆
P3	5÷10 ☆	N3	5÷10 ☆
P4	5÷8 ☆	N4	5÷10 ☆

★ 1st choice ☆ suitable

ST

ROLL

CARBIDE

LONG

HAND TAPS

EG (STI)

SPECIAL THREADS, GAUGES

THREAD MILLS

DIES

CENTER DRILLS

Technical info



FEATURES

General purpose for deep blind hole application.

For tapping steel at medium-low cutting speed, also suitable for non-ferrous materials.

BLF geometry allows smooth chip ejection.

This item will be gradually replaced by:

· SP page 94

TYPE: EU_140

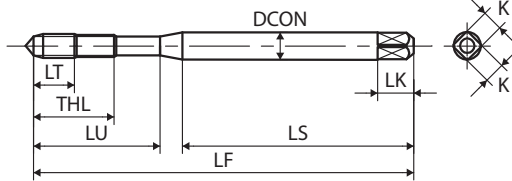

TYPE: EU_025

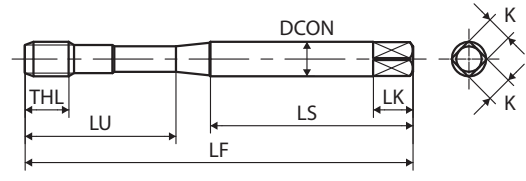

TYPE: EU_023

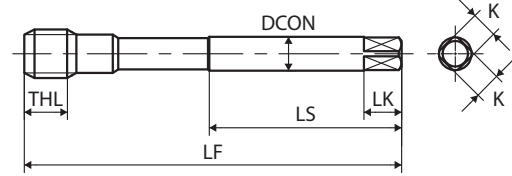

M	TCTR (tolerance)	 Hole Ø (mm)	Hole Ø (mm)	Code	THCHT (chamfer)	LF (mm)	LT (mm)	THL (mm)	LU (mm)	LS (mm)	DCON (mm)	K (mm)	LK (mm)	NOF	Type	Stock
DIN 371																
M3X0.5	IS02(6H)	2.5	2.56	SD3.0GANEBJ	2.5P	56	-	9	18	34	3.5	6	2.7	3	140	▽
M4X0.7	IS02(6H)	3.3	3.38	SD4.0IANEBJ	2.5P	63	-	13	21	38	4.5	6	3.4	3	140	▽
M5X0.8	IS02(6H)	4.2	4.28	SD5.0KANEBJ	2.5P	70	-	14	25	39	6	8	4.9	3	140	▽
M6X1	IS02(6H)	5	5.09	SD6.0MANEBJ	2.5P	80	-	15	30	45	6	8	4.9	3	140	▽
M8X1.25	IS02(6H)	6.8	6.85	SD8.0NANEBJ	2.5P	90	-	19	35	47	8	9	6.2	3	025	▽
M10X1.5	IS02(6H)	8.5	8.6	SD0100ANEBJ	2.5P	100	-	23	39	52	10	11	8	3	025	▽
DIN 376																
M12X1.75	IS02(6H)	10.3	10.36	SG012PANEBJ	2.5P	110	-	26	-	56	9	10	7	3	023	▽
M14X2	IS02(6H)	12	12.12	SG014QANEBJ	2.5P	110	-	26	-	56	11	12	9	3	023	▽
M16X2	IS02(6H)	14	14.12	SG016QANEBJ	2.5P	110	-	26	-	56	12	12	9	3	023	▽
M18X2.5	IS02(6H)	15.5	15.63	SG018RANEBJ	2.5P	125	-	33	-	64	14	14	11	4	023	▽
M20X2.5	IS02(6H)	17.5	17.63	SG020RANEBJ	2.5P	140	-	33	-	71	16	15	12	4	023	▽
M24X3	IS02(6H)	21	21.13	SG024SANEBJ	2.5P	160	-	37	-	82	18	17	14.5	4	023	▽

Intro

SP

DIN

SL

PO

ST

ROLL

CARBIDE

LONG

HAND
TAPS

EG (STI)

SPECIAL
THREADS,
GAUGESTHREAD
MILLS

DIES

CENTER
DRILLSTechnical
info

Intro

SP-BLF 1.5P

GP General Purpose Series

Spiral Fluted Taps 1.5P, Deep Hole Use



SP

DIN

SL



PO

Recommended Tapping Speeds Depending On Materials

ISO	Vc (m/min)	ISO	Vc (m/min)
P1	5÷10 ☆	N1	5÷10 ☆
P2	5÷10 ★	N2	5÷10 ☆
P3	5÷10 ☆	N3	5÷10 ☆
P4	5÷8 ☆	N4	5÷10 ☆

★ 1st choice ☆ suitable

ST

ROLL

CARBIDE

LONG

HAND TAPS

EG (STI)

SPECIAL THREADS, GAUGES

THREAD MILLS

DIES

CENTER DRILLS

Technical info

FEATURES

General purpose with BLF geometry for deep blind hole application.



For tapping steel at medium-low cutting speed, also suitable for non-ferrous materials.

1.5P extra short chamfer for tapping till the bottom of the hole.

This item will be gradually replaced by:

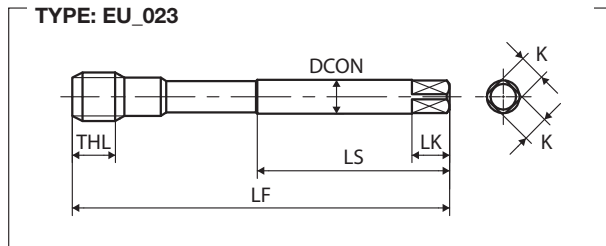
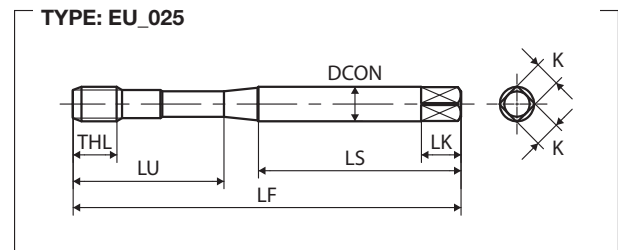
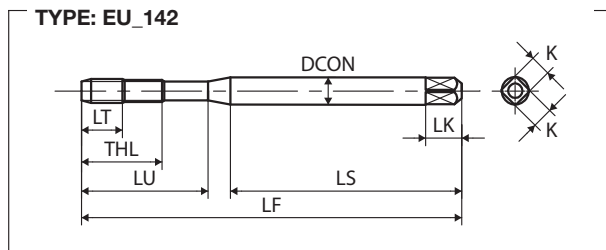
- VUSP E(1.5P) page 82
- SP 1.5P JIS page 160



M	TCTR (tolerance)	 Hole Ø (mm)	Hole Ø (mm)	Code	THCHT (chamfer)	LF (mm)	LT (mm)	THL (mm)	LU (mm)	LS (mm)	DCON (mm)	K (mm)	LK (mm)	NOF	Type	Stock
DIN 371																
M4X0.7	IS02(6H)	3.3	3.38	SD4.0IANEBAJ	1.5P	63	-	13	21	38	4.5	6	3.4	3	142	▽
M5X0.8	IS02(6H)	4.2	4.28	SD5.0KANEB AJ	1.5P	70	-	14	25	39	6	8	4.9	3	142	▽
M6X1	IS02(6H)	5	5.09	SD6.0MANEB AJ	1.5P	80	-	15	30	45	6	8	4.9	3	142	▽
M8X1.25	IS02(6H)	6.8	6.85	SD8.0NANEBAJ	1.5P	90	-	19	35	47	8	9	6.2	3	025	▽
M10X1.5	IS02(6H)	8.5	8.6	SD0100ANEBAJ	1.5P	100	-	23	39	52	10	11	8	3	025	▽
M	TCTR (tolerance)	 Hole Ø (mm)	Hole Ø (mm)	Code	THCHT (chamfer)	LF (mm)	LT (mm)	THL (mm)	LU (mm)	LS (mm)	DCON (mm)	K (mm)	LK (mm)	NOF	Type	Stock
DIN 376																
M12X1.75	IS02(6H)	10.3	10.36	SG012PANEB AJ	1.5P	110	-	26	-	56	9	10	7	3	023	▽

Intro

SP

DIN

SL

PO

ST

ROLL

CARBIDE

LONG

HAND
TAPS

EG (STI)

SPECIAL
THREADS,
GAUGESTHREAD
MILLS

DIES

CENTER
DRILLSTechnical
info

Intro

SP LH

GP General Purpose Series

Spiral Fluted Taps for Left Hand Threads

SP

DIN

SL

PO

ST

ROLL

CARBIDE

LONG

HAND TAPS

EG (STI)

SPECIAL THREADS, GAUGES

THREAD MILLS

DIES

CENTER DRILLS

Technical info



FEATURES

General purpose for blind hole application.

For tapping steel at medium-low cutting speed, also suitable for non-ferrous materials.



For left hand threads.

Recommended Tapping Speeds Depending On Materials

ISO	Vc (m/min)	ISO	Vc (m/min)
P1	5÷10 ☆	N1	5÷10 ☆
P2	5÷10 ★	N2	5÷10 ☆
P3	5÷10 ☆	N3	5÷10 ☆
P4	5÷8 ☆	N4	5÷10 ☆

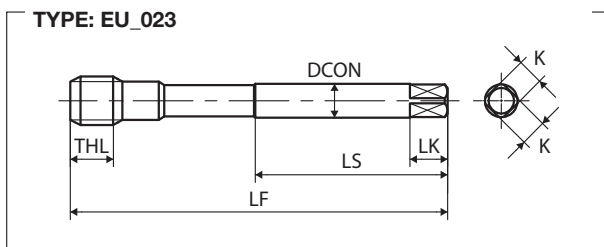
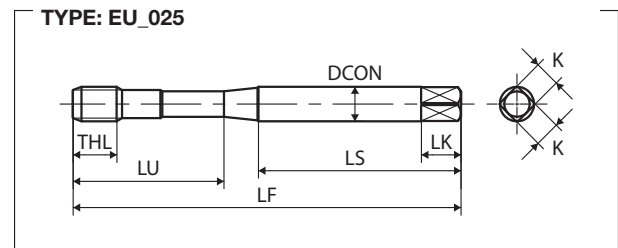
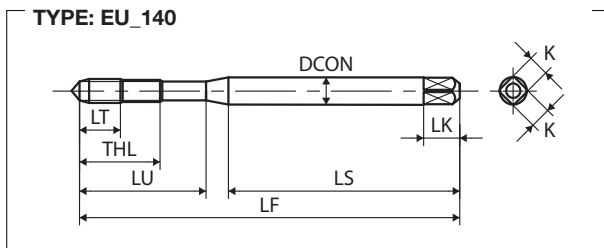
★ 1st choice ☆ suitable



M	TCTR (tolerance)	 Hole Ø (mm)	Hole Ø (mm)	Code	THCHT (chamfer)	LF (mm)	LT (mm)	THL (mm)	LU (mm)	LS (mm)	DCON (mm)	K (mm)	LK (mm)	NOF	Type	Stock
DIN 371																
M4X0.7	IS02(6H)	3.3	3.38	HD4.0IANEB	2.5P	63	7	13	21	38	4.5	3.4	6	3	140	●
M5X0.8	IS02(6H)	4.2	4.28	HD5.0KANEB	2.5P	70	9	14	25	39	6	4.9	8	3	140	●
M6X1	IS02(6H)	5	5.09	HD6.0MANEB	2.5P	80	11	15	30	45	6	4.9	8	3	140	●
M8X1.25	IS02(6H)	6.8	6.85	HD8.0NANEB	2.5P	90	-	12	35	47	8	6.2	9	3	025	●
M10X1.5	IS02(6H)	8.5	8.6	HD0100ANEB	2.5P	100	-	13	39	52	10	8	11	3	025	●
M	TCTR (tolerance)	 Hole Ø (mm)	Hole Ø (mm)	Code	THCHT (chamfer)	LF (mm)	LT (mm)	THL (mm)	LU (mm)	LS (mm)	DCON (mm)	K (mm)	LK (mm)	NOF	Type	Stock
DIN 376																
M12X1.75	IS02(6H)	10.3	10.36	HG012PANEB	2.5P	110	-	15	-	56	9	7	10	3	023	●
M14X2	IS02(6H)	12	12.12	HG014QANEB	2.5P	110	-	18	-	56	11	9	12	3	023	●
M16X2	IS02(6H)	14	14.12	HG016QANEB	2.5P	110	-	18	-	56	12	9	12	3	023	●
M18X2.5	IS02(6H)	15.5	15.63	HG018RANEB	2.5P	125	-	20	-	64	14	11	14	4	023	○
M20X2.5	IS02(6H)	17.5	17.63	HG020RANEB	2.5P	140	-	20	-	71	16	12	15	4	023	●
MF	TCTR (tolerance)	 Hole Ø (mm)	Hole Ø (mm)	Code	THCHT (chamfer)	LF (mm)	LT (mm)	THL (mm)	LU (mm)	LS (mm)	DCON (mm)	K (mm)	LK (mm)	NOF	Type	Stock
DIN 374																
M8X1	IS02(6H)	7	7.09	HM8.0MANEB	2.5P	90	-	12	-	46	6	4.9	8	3	023	○
M14X1.5	IS02(6H)	12.5	12.6	HM0140ANEB	2.5P	100	-	14	-	51	11	9	12	3	023	○
M16X1.5	IS02(6H)	14.5	14.6	HM0160ANEB	2.5P	100	-	14	-	51	12	9	12	3	023	○

Intro

SP

DIN

SL

PO

ST

ROLL

CARBIDE

LONG

HAND
TAPS

EG (STI)

SPECIAL
THREADS,
GAUGESTHREAD
MILLS

DIES

CENTER
DRILLSTechnical
info

Intro

SP-BLF OX

GP General Purpose Series

Spiral Fluted Taps, Deep Hole Use, Oxided

SP

DIN

SL



PO

Recommended Tapping Speeds Depending On Materials

ISO	Vc (m/min)		ISO	Vc (m/min)	
P1	5÷10	★	M1	4÷8	☆
P2	5÷10	★			
P3	5÷10	☆			
P4	5÷8	☆			
P5	4÷7	☆			
P7	4÷8	☆			

★ 1st choice ☆ suitable

ST

ROLL

CARBIDE

LONG

HAND TAPS

EG (STI)

SPECIAL THREADS, GAUGES

THREAD MILLS

DIES

CENTER DRILLS

Technical info



FEATURES

General purpose for deep blind hole application.

For tapping steel at medium-low cutting speed, also suitable for alloy steel and stainless steel application.

OX treatment reduces welding troubles, BLF geometry improves chip ejection.

TYPE: EU_140

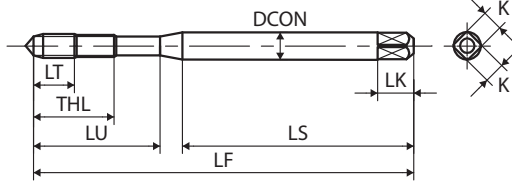

TYPE: EU_025

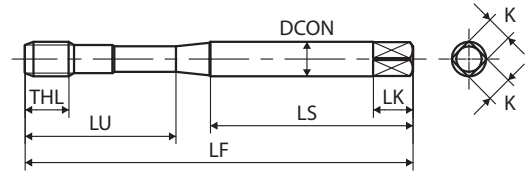

TYPE: EU_023

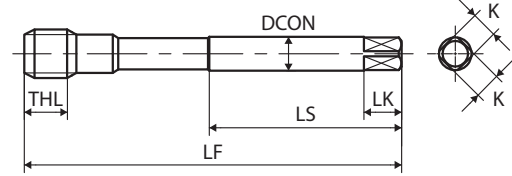

M	TCTR (tolerance)	 Hole Ø (mm)	Hole Ø (mm)	Code	THCHT (chamfer)	LF (mm)	LT (mm)	THL (mm)	LU (mm)	LS (mm)	DCON (mm)	K (mm)	LK (mm)	NOF	Type	Stock
DIN 371																
M3X0.5	ISO2(6H)	2.5	2.56	SD3.0GANEXJ	2.5P	56	-	9	18	34	3.5	2.7	6	3	140	●
M4X0.7	ISO2(6H)	3.3	3.38	SD4.0IANEXJ	2.5P	63	-	13	21	38	4.5	3.4	6	3	140	●
M5X0.8	ISO2(6H)	4.2	4.28	SD5.0KANEXJ	2.5P	70	-	14	25	39	6	4.9	8	3	140	●
M6X1	ISO2(6H)	5	5.09	SD6.0MANEXJ	2.5P	80	-	15	30	45	6	4.9	8	3	140	●
M8X1.25	ISO2(6H)	6.8	6.85	SD8.0NANEXJ	2.5P	90	-	19	35	47	8	6.2	9	3	025	●
M10X1.5	ISO2(6H)	8.5	8.6	SD0100ANEXJ	2.5P	100	-	23	39	52	10	8	11	3	025	●
DIN 376																
M12X1.75	ISO2(6H)	10.3	10.36	SG012PANEXJ	2.5P	110	-	26	-	56	9	7	10	3	023	●
M14X2	ISO2(6H)	12	12.12	SG014QANEXJ	2.5P	110	-	26	-	56	11	9	12	3	023	●
M16X2	ISO2(6H)	14	14.12	SG016QANEXJ	2.5P	110	-	26	-	56	12	9	12	3	023	●
M18X2.5	ISO2(6H)	15.5	15.63	SG018RANEXJ	2.5P	125	-	33	-	64	14	11	14	4	023	●
M20X2.5	ISO2(6H)	17.5	17.63	SG020RANEXJ	2.5P	140	-	33	-	71	16	12	15	4	023	●
M22X2.5	ISO2(6H)	19.5	19.63	SG022RANEXJ	2.5P	140	-	33	-	71	18	14.5	17	4	023	●
M24X3	ISO2(6H)	21	21.13	SG024SANEXJ	2.5P	160	-	37	-	82	18	14.5	17	4	023	●
M27X3	ISO2(6H)	24	24.13	SG027SANEXJ	2.5P	160	-	37	-	82	20	16	19	4	023	●
M30X3.5	ISO2(6H)	26.5	26.63	SG030TANEXJ	2.5P	180	-	44	-	92	22	18	21	4	023	●
M33X3.5	ISO2(6H)	29.5	29.63	SG033TANEXJ	2.5P	180	-	46	-	92	25	20	23	4	023	●
M36X4	ISO2(6H)	32	32.12	SG036UANEXJ	2.5P	200	-	52	-	102	28	22	25	4	023	●

Intro

SP

DIN

SL

PO

ST

ROLL

CARBIDE

LONG

HAND TAPS

EG (STI)

SPECIAL THREADS, GAUGES

THREAD MILLS

DIES

CENTER DRILLS

Technical info

Intro

SP OX

GP General Purpose Series

Spiral Fluted Taps, Oxided

SP

DIN

SL



PO

Recommended Tapping Speeds Depending On Materials

ISO	Vc (m/min)		ISO	Vc (m/min)	
P1	5÷10	★	M1	4÷8	☆
P2	5÷10	★			
P3	5÷10	☆			
P4	5÷8	☆			
P5	4÷7	☆			
P7	4÷8	☆			

★ 1st choice ☆ suitable

ST

ROLL

CARBIDE

LONG

HAND TAPS

EG (STI)

SPECIAL THREADS, GAUGES

THREAD MILLS

DIES

CENTER DRILLS

Technical info



FEATURES

General purpose for blind hole application.
For tapping steel at medium-low cutting speed, also suitable for non-ferrous materials.
With OX treatment to reduce welding troubles.

This item will be gradually replaced by:

- SP page 94
- SP-VA page 132

TYPE: EU_141

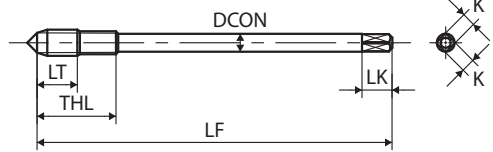

TYPE: EU_023

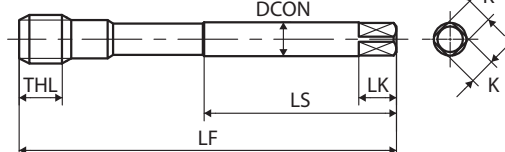

TYPE: EU_025

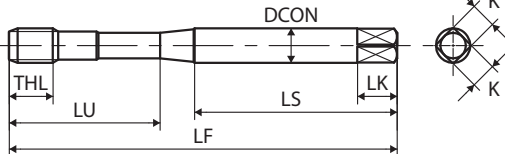

MF	TCTR (tolerance)	 Hole Ø (mm)	Hole Ø (mm)	Code	THCHT (chamfer)	LF (mm)	LT (mm)	THL (mm)	LU (mm)	LS (mm)	DCON (mm)	K (mm)	LK (mm)	NOF	Type	Stock
DIN 374																
M4X0.5	ISO2(6H)	3.5	3.56	SM4.0GANEX	2.5P	63	9	9	-	-	2.8	2.1	5	3	141	▽
M5X0.5	ISO2(6H)	4.5	4.56	SM5.0GANEX	2.5P	70	11	11	-	-	3.5	2.7	6	3	141	▽
M6X0.75	ISO2(6H)	5.3	5.33	SM6.0JANEX	2.5P	80	13	13	-	-	4.5	3.4	6	3	141	▽
M6X0.5	ISO2(6H)	5.5	5.56	SM6.0GANEX	2.5P	80	13	13	-	-	4.5	3.4	6	3	141	▽
M8X1	ISO2(6H)	7	7.09	SM8.0MANEX	2.5P	90	-	12	-	46	6	4.9	8	3	023	▽
M8X0.75	ISO2(6H)	7.3	7.33	SM8.0JANEX	2.5P	80	-	12	-	41	6	4.9	8	3	023	▽
M10X1.25	ISO2(6H)	8.8	8.85	SM010NANEX	2.5P	100	-	13	-	51	7	5.5	8	3	023	▽
M10X1	ISO2(6H)	9	9.09	SM010MANEX	2.5P	90	-	13	-	46	7	5.5	8	3	023	▽
M10X0.75	ISO2(6H)	9.3	9.33	SM010JANEX	2.5P	90	-	13	-	46	7	5.5	8	3	025	▽
M12X1.5	ISO2(6H)	10.5	10.6	SM012OANEX	2.5P	100	-	15	-	51	9	7	10	3	023	▽
M12X1.25	ISO2(6H)	10.8	10.85	SM012NANEX	2.5P	100	-	15	-	51	9	7	10	3	023	▽
M12X1	ISO2(6H)	11	11.09	SM012MANEX	2.5P	100	-	15	-	51	9	7	10	3	023	▽
M14X1.5	ISO2(6H)	12.5	12.6	SM014OANEX	2.5P	100	-	14	-	51	11	9	12	3	023	▽
M14X1.25	ISO2(6H)	12.8	12.85	SM014NANEX	2.5P	100	-	14	-	51	11	9	12	3	023	▽
M14X1	ISO2(6H)	13	13.09	SM014MANEX	2.5P	100	-	14	-	51	11	9	12	3	023	▽
M16X1.5	ISO2(6H)	14.5	14.6	SM016OANEX	2.5P	100	-	14	-	51	12	9	12	3	023	▽
M16X1	ISO2(6H)	15	15.09	SM016MANEX	2.5P	100	-	14	-	51	12	9	12	3	023	▽
M18X2	ISO2(6H)	16	16.12	SM018QANEX	2.5P	125	-	18	-	64	14	11	14	4	023	▽
M18X1.5	ISO2(6H)	16.5	16.6	SM018OANEX	2.5P	110	-	14	-	56	14	11	14	4	023	▽
M18X1	ISO2(6H)	17	17.09	SM018MANEX	2.5P	110	-	14	-	56	14	11	14	4	023	▽
M20X2	ISO2(6H)	18	18.12	SM020QANEX	2.5P	140	-	18	-	71	16	12	15	4	023	▽
M20X1.5	ISO2(6H)	18.5	18.6	SM020OANEX	2.5P	125	-	14	-	64	16	12	15	4	023	▽
M20X1	ISO2(6H)	19	19.09	SM020MANEX	2.5P	125	-	14	-	64	16	12	15	4	023	▽
M22X2	ISO2(6H)	20	20.12	SM022QANEX	2.5P	140	-	18	-	71	18	14.5	17	4	023	▽
M22X1.5	ISO2(6H)	20.5	20.6	SM022OANEX	2.5P	125	-	14	-	64	18	14.5	17	4	023	▽
M22X1	ISO2(6H)	21	21.09	SM022MANEX	2.5P	125	-	14	-	64	18	14.5	17	4	023	▽
M24X2	ISO2(6H)	22	22.12	SM024QANEX	2.5P	140	-	18	-	71	18	14.5	17	4	023	▽
M24X1.5	ISO2(6H)	22.5	22.6	SM024OANEX	2.5P	140	-	18	-	71	18	14.5	17	4	023	▽
M24X1	ISO2(6H)	23	23.09	SM024MANEX	2.5P	140	-	18	-	71	18	14.5	17	4	023	▽
M25X1.5	ISO2(6H)	23.5	23.6	SM025OANEX	2.5P	140	-	18	-	71	18	14.5	17	4	023	▽
M26X1.5	ISO2(6H)	24.5	24.6	SM026OANEX	2.5P	140	-	18	-	71	18	14.5	17	4	023	▽
M27X2	ISO2(6H)	25	25.12	SM027QANEX	2.5P	140	-	20	-	71	20	16	19	4	023	▽
M27X1.5	ISO2(6H)	25.5	25.6	SM027OANEX	2.5P	140	-	20	-	71	20	16	19	4	023	▽
M27X1	ISO2(6H)	26	26.09	SM027MANEX	2.5P	140	-	20	-	71	20	16	19	4	023	▽
M28X2	ISO2(6H)	26	26.12	SM028QANEX	2.5P	140	-	20	-	71	20	16	19	4	023	▽
M28X1.5	ISO2(6H)	26.5	26.6	SM028OANEX	2.5P	140	-	20	-	71	20	16	19	4	023	▽
M28X1	ISO2(6H)	27	27.09	SM028MANEX	2.5P	140	-	20	-	71	20	16	19	4	023	▽
M30X2	ISO2(6H)	28	28.12	SM030QANEX	2.5P	150	-	20	-	77	22	18	21	4	023	▽
M30X1.5	ISO2(6H)	28.5	28.6	SM030OANEX	2.5P	150	-	20	-	77	22	18	21	4	023	▽
M30X1	ISO2(6H)	29	29.09	SM030MANEX	2.5P	150	-	20	-	77	22	18	21	4	023	▽
M32X2	ISO2(6H)	30	30.12	SM032QANEX	2.5P	150	-	20	-	77	22	18	21	4	023	▽
M32X1.5	ISO2(6H)	30.5	30.6	SM032OANEX	2.5P	150	-	20	-	77	22	18	21	4	023	▽
M32X1	ISO2(6H)	31	31.09	SM032MANEX	2.5P	150	-	20	-	77	22	18	21	4	023	▽
M33X2	ISO2(6H)	31	31.12	SM033QANEX	2.5P	160	-	20	-	82	25	20	23	4	023	▽
M33X1.5	ISO2(6H)	31.5	31.6	SM033OANEX	2.5P	160	-	20	-	82	25	20	23	4	023	▽
M33X1	ISO2(6H)	32	32.09	SM033MANEX	2.5P	160	-	20	-	82	25	20	23	4	023	▽
M35X1.5	ISO2(6H)	33.5	33.6	SM035OANEX	2.5P	170	-	20	-	87	28	22	25	4	023	▽

Intro

SP

DIN

SL

PO

ST

ROLL

CARBIDE

LONG

HAND
TAPS

EG (STI)

SPECIAL
THREADS,
GAUGESTHREAD
MILLS

DIES

CENTER
DRILLSTechnical
info

Spiral Fluted Taps

Intro

SP

DIN

SL

PO

ST

ROLL

CARBIDE

LONG

HAND TAPS

EG (STI)



SPECIAL THREADS, GAUGES

THREAD MILLS

DIES

CENTER DRILLS

Technical info

MF	TCTR (tolerance)	 Hole Ø (mm)	Hole Ø (mm)	Code	THCHT (chamfer)	LF (mm)	LT (mm)	THL (mm)	LU (mm)	LS (mm)	DCON (mm)	K (mm)	LK (mm)	NOF	Type	Stock
DIN 374																
M36X3	IS02(6H)	33	33.13	SM036SANEX	2.5P	200	-	30	-	102	28	22	25	4	023	▽
M36X2	IS02(6H)	34	34.12	SM036QANEX	2.5P	170	-	20	-	87	28	22	25	4	023	▽
M36X1.5	IS02(6H)	34.5	34.6	SM036OANEX	2.5P	170	-	20	-	87	28	22	25	4	023	▽
G(BSP)	TCTR (tolerance)	 Hole Ø (mm)	Hole Ø (mm)	Code	THCHT (chamfer)	Basic major Ø (mm)	LF (mm)	THL (mm)	LS (mm)	DCON (mm)	K (mm)	LK (mm)	NOF	Type	Stock	
DIN 5156																
1/8-28	-	8.75	8.78	SVG0020NEX	2.5P	9.728	90	12	46	7	5.5	8	3	023	▽	
1/4-19	-	11.75	11.78	SVG0040NEX	2.5P	13.157	100	14	51	11	9	12	3	023	▽	
3/8-19	-	15.25	15.28	SVG0060NEX	2.5P	16.662	100	14	51	12	9	12	3	023	▽	
1/2-14	-	19	19.04	SVG0080NEX	2.5P	20.955	125	18	64	16	12	15	4	023	▽	
5/8-14	-	21	21	SVG0100NEX	2.5P	22.911	125	18	64	18	14.5	17	4	023	▽	
3/4-14	-	24.5	24.52	SVG0120NEX	2.5P	26.441	140	20	71	20	16	19	4	023	▽	
7/8-14	-	28.25	28.28	SVG0140NEX	2.5P	30.201	150	20	77	22	18	21	4	023	○	
1-11	-	30.75	30.77	SVG0160NEX	2.5P	33.249	160	20	82	25	20	23	4	023	▽	
1 1/4-11	-	39.3	39.43	SVG0200NEX	2.5P	41.910	170	20	87	32	24	27	4	023	▽	
1 1/2-11	-	45.25	45.33	SVG0240NEX	2.5P	47.803	190	25	97	36	29	32	4	023	▽	

Intro

SP

DIN

SL

PO

ST

ROLL

CARBIDE

LONG

HAND
TAPS

EG (STI)

SPECIAL
THREADS,
GAUGES

THREAD
MILLS

DIES

CENTER
DRILLS

Technical
info

Intro

SP-BLF V

GP General Purpose Series

Spiral Fluted Taps, Deep Hole Use, Coated

SP

DIN

SL

PO

ST

ROLL

CARBIDE

LONG

HAND TAPS

EG (STI)

SPECIAL THREADS, GAUGES

THREAD MILLS

DIES

CENTER DRILLS

Technical info



FEATURES

General purpose for blind hole application.

For tapping steel, also suitable for stainless steel and non-ferrous materials application.

BLF geometry reduces edge chipping trouble and improves chip ejection.

Recommended Tapping Speeds Depending On Materials

ISO	Vc (m/min)	ISO	Vc (m/min)	ISO	Vc (m/min)
P1	10÷20 ★	M1	6÷12 ☆	N1	10÷20 ☆
P2	10÷20 ★			N2	10÷20 ☆
P3	10÷20 ★			N3	10÷20 ☆
P4	10÷15 ★			N4	10÷20 ☆
P7	6÷12 ☆				

★ 1st choice ☆ suitable

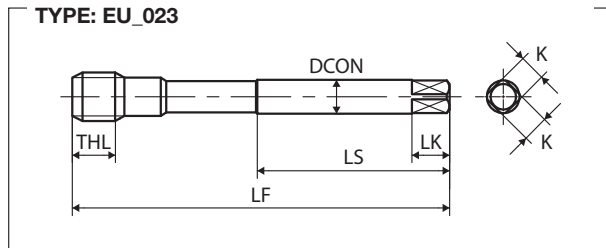
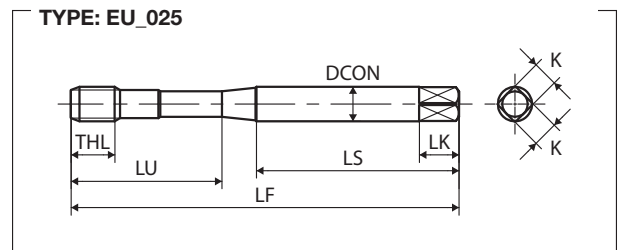
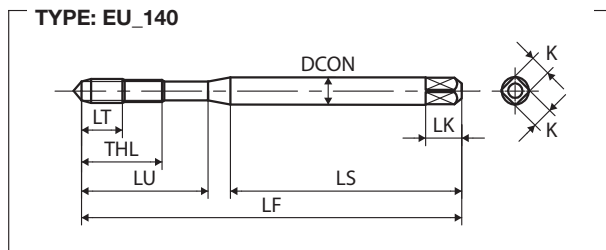

M	TCTR (tolerance)	 Hole Ø (mm)	Hole Ø (mm)	Code	THCHT (chamfer)	LF (mm)	LT (mm)	THL (mm)	LU (mm)	LS (mm)	DCON (mm)	K (mm)	LK (mm)	NOF	Type	Stock
DIN 371																
M3X0.5	ISO2(6H)	2.5	2.56	96473.0TI	2.5P	56	-	9	18	34	3.5	2.7	6	3	140	●
M4X0.7	ISO2(6H)	3.3	3.38	96474.0TI	2.5P	63	-	13	21	38	4.5	3.4	6	3	140	●
M5X0.8	ISO2(6H)	4.2	4.28	96475.0TI	2.5P	70	-	14	25	39	6	4.9	8	3	140	●
M6X1	ISO2(6H)	5	5.09	96476.0TI	2.5P	80	-	15	30	45	6	4.9	8	3	140	●
M8X1.25	ISO2(6H)	6.8	6.85	96478.0TI	2.5P	90	-	19	35	47	8	6.2	9	3	025	●
M10X1.5	ISO2(6H)	8.5	8.6	9647010TI	2.5P	100	-	23	39	52	10	8	11	3	025	●
DIN 376																
M12X1.75	ISO2(6H)	10.3	10.36	9747012TI	2.5P	110	-	26	-	56	9	7	10	3	023	●
M14X2	ISO2(6H)	12	12.12	9747014TI	2.5P	110	-	26	-	56	11	9	12	3	023	●
M16X2	ISO2(6H)	14	14.12	9747016TI	2.5P	110	-	26	-	56	12	9	12	3	023	●
M18X2.5	ISO2(6H)	15.5	15.63	9747018TI	2.5P	125	-	33	-	64	14	11	14	4	023	●
M20X2.5	ISO2(6H)	17.5	17.63	9747020TI	2.5P	140	-	33	-	71	16	12	15	4	023	●
M22X2.5	ISO2(6H)	19.5	19.63	9747022TI	2.5P	140	-	33	-	71	18	14.5	17	4	023	●
M24X3	ISO2(6H)	21	21.13	9747024TI	2.5P	160	-	37	-	82	18	14.5	17	4	023	●

Intro

SP

DIN

SL

PO

ST

ROLL

CARBIDE

LONG

HAND
TAPS

EG (STI)

SPECIAL
THREADS,
GAUGESTHREAD
MILLS

DIES

CENTER
DRILLSTechnical
info

Intro

SP V

GP General Purpose Series

Spiral Fluted Taps, Coated

SP

DIN

SL



PO

Recommended Tapping Speeds Depending On Materials

ISO	Vc (m/min)		ISO	Vc (m/min)		ISO	Vc (m/min)	
P1	10÷20	★	M1	6÷12	☆	N1	10÷20	☆
P2	10÷20	★				N2	10÷20	☆
P3	10÷20	★				N3	10÷20	☆
P4	10÷15	★				N4	10÷20	☆
P7	6÷12	☆						

★ 1st choice ☆ suitable

ROLL

CARBIDE

LONG

HAND TAPS

EG (STI)

SPECIAL THREADS, GAUGES

THREAD MILLS

DIES

CENTER DRILLS

Technical info



FEATURES

General purpose for blind hole application.

For tapping steel, also suitable for stainless steel and non-ferrous materials.

Adopting suitable coating to improve performances.

TYPE: EU_023

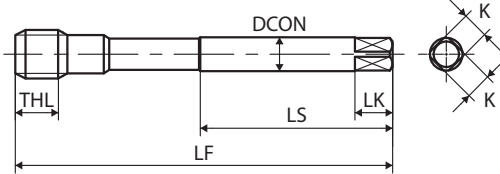

MF	TCTR (tolerance)	∅ (mm)	Hole ∅ (mm)	Code	THCHT (chamfer)	LF (mm)	LT (mm)	THL (mm)	LU (mm)	LS (mm)	DCON (mm)	K (mm)	LK (mm)	NOF	Type	Stock
DIN 374																
M8X1	ISO2(6H)	7	7.09	98408.0MTI	2.5P	90	-	12	-	46	6	4.9	8	3	023	●
M10X1.25	ISO2(6H)	8.8	8.85	9840010NTI	2.5P	100	-	13	-	51	7	5.5	8	3	023	●
M10X1	ISO2(6H)	9	9.09	9840010MTI	2.5P	90	-	13	-	46	7	5.5	8	3	023	●
M12X1.5	ISO2(6H)	10.5	10.6	98400120TI	2.5P	100	-	15	-	51	9	7	10	3	023	●
M12X1.25	ISO2(6H)	10.8	10.85	9840012NTI	2.5P	100	-	15	-	51	9	7	10	3	023	●
M14X1.5	ISO2(6H)	12.5	12.6	98400140TI	2.5P	100	-	14	-	51	11	9	12	3	023	●
M16X1.5	ISO2(6H)	14.5	14.6	98400160TI	2.5P	100	-	14	-	51	12	9	12	3	023	●
M18X1.5	ISO2(6H)	16.5	16.6	98400180TI	2.5P	110	-	14	-	56	14	11	14	4	023	●
M20X1.5	ISO2(6H)	18.5	18.6	98400200TI	2.5P	125	-	14	-	64	16	12	15	4	023	●
G(BSP)	TCTR (tolerance)	∅ (mm)	Hole ∅ (mm)	Code	THCHT (chamfer)	Basic major ∅ (mm)	LF (mm)	THL (mm)	LS (mm)	DCON (mm)	K (mm)	LK (mm)	NOF	Type	Stock	
DIN 5156																
1/8-28	-	8.75	8.78	9940R02TI	2.5P	9.728	90	12	46	7	5.5	8	3	023	●	
1/4-19	-	11.75	11.78	9940R04TI	2.5P	13.157	100	14	51	11	9	12	3	023	●	
3/8-19	-	15.25	15.28	9940R06TI	2.5P	16.662	100	14	51	12	9	12	3	023	●	
1/2-14	-	19	19.04	9940R08TI	2.5P	20.955	125	18	64	16	12	15	4	023	●	

Intro

SP

DIN

SL

PO

ST

ROLL

CARBIDE

LONG

HAND
TAPS

EG (STI)

SPECIAL
THREADS,
GAUGESTHREAD
MILLS

DIES

CENTER
DRILLSTechnical
info

Intro

LO-SP

GP General Purpose Series

Low Spiral Fluted Taps

SP

DIN

SL



PO

Recommended Tapping Speeds Depending On Materials

ISO	Vc (m/min)	ISO	Vc (m/min)	ISO	Vc (m/min)
P2	5±10 ★	K1	5±10 ☆	N1	5±10 ☆
P3	5±10 ★	K2	5±10 ☆	N2	5±10 ☆
P4	5±10 ☆	K3	5±10 ☆	N3	5±10 ☆
				N4	5±10 ☆

★ 1st choice ☆ suitable

ROLL

CARBIDE

LONG

HAND TAPS

EG (STI)

SPECIAL THREADS, GAUGES

THREAD MILLS

DIES

CENTER DRILLS

Technical info



FEATURES

General purpose for blind hole application on medium tensile strength steel.





Low helix produces short chips.

Very suitable for horizontal tapping.

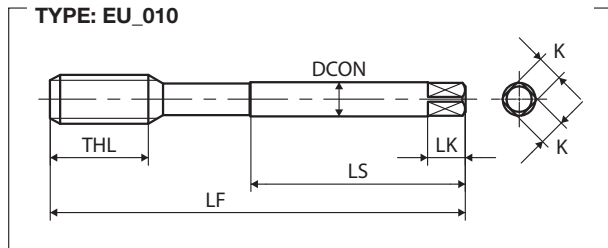
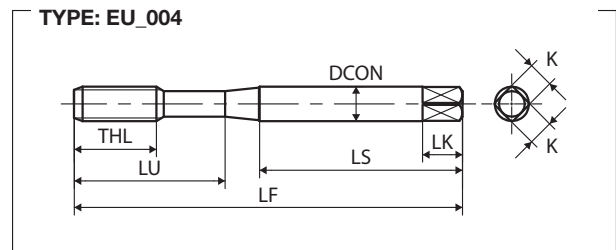
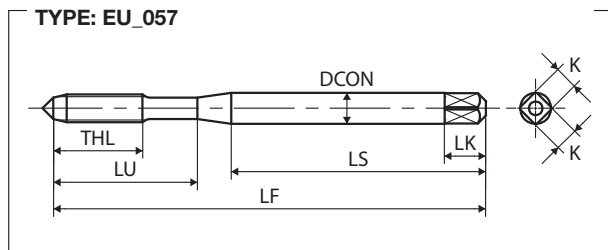
This item will be gradually replaced by:

· LO-SP OX page 118



M	TCTR (tolerance)	 Hole Ø (mm)	Hole Ø (mm)	Code	THCHT (chamfer)	LF (mm)	LT (mm)	THL (mm)	LU (mm)	LS (mm)	DCON (mm)	K (mm)	LK (mm)	NOF	Type	Stock
DIN 371																
M3X0.5	IS02(6H)	2.5	2.56	SD3.0GANEBH	3.5P	56	-	9	18	34	3.5	2.7	6	2	057	▽
M4X0.7	IS02(6H)	3.3	3.38	SD4.0IANEBH	3.5P	63	-	13	21	38	4.5	3.4	6	3	057	▽
M5X0.8	IS02(6H)	4.2	4.28	SD5.0KANEBH	3.5P	70	-	14	25	39	6	4.9	8	3	057	▽
M6X1	IS02(6H)	5	5.09	SD6.0MANEBH	3.5P	80	-	15	30	45	6	4.9	8	3	057	▽
M8X1.25	IS02(6H)	6.8	6.85	SD8.0NANEBH	3.5P	90	-	19	35	47	8	6.2	9	3	004	▽
M10X1.5	IS02(6H)	8.5	8.6	SD0100ANEBH	3.5P	100	-	23	39	52	10	8	11	3	004	▽
M	TCTR (tolerance)	 Hole Ø (mm)	Hole Ø (mm)	Code	THCHT (chamfer)	LF (mm)	LT (mm)	THL (mm)	LU (mm)	LS (mm)	DCON (mm)	K (mm)	LK (mm)	NOF	Type	Stock
DIN 376																
M12X1.75	IS02(6H)	10.3	10.36	SG012PANEBH	3.5P	110	-	26	-	56	9	7	10	3	010	▽
M14X2	IS02(6H)	12	12.12	SG014QANEBH	3.5P	110	-	26	-	56	11	9	12	3	010	▽
M16X2	IS02(6H)	14	14.12	SG016QANEBH	3.5P	110	-	26	-	56	12	9	12	3	010	▽
MF	TCTR (tolerance)	 Hole Ø (mm)	Hole Ø (mm)	Code	THCHT (chamfer)	LF (mm)	LT (mm)	THL (mm)	LU (mm)	LS (mm)	DCON (mm)	K (mm)	LK (mm)	NOF	Type	Stock
DIN 374																
M8X1	IS02(6H)	7	7.09	SM8.0MANEBH	3.5P	90	-	19	-	46	6	4.9	8	3	010	▽
M10X1.25	IS02(6H)	8.8	8.85	SM010NANEBH	3.5P	100	-	23	-	51	7	5.5	8	3	010	▽
M10X1	IS02(6H)	9	9.09	SM010MANEBH	3.5P	90	-	19	-	46	7	5.5	8	3	010	▽
M12X1.5	IS02(6H)	10.5	10.6	SM0120ANEBH	3.5P	100	-	21	-	51	9	7	10	3	010	▽
M12X1.25	IS02(6H)	10.8	10.85	SM012NANEBH	3.5P	100	-	21	-	51	9	7	10	3	010	▽
M12X1	IS02(6H)	11	11.09	SM012MANEBH	3.5P	100	-	21	-	51	9	7	10	3	010	▽
M14X1.5	IS02(6H)	12.5	12.6	SM0140ANEBH	3.5P	100	-	21	-	51	11	9	12	3	010	▽
M16X1.5	IS02(6H)	14.5	14.6	SM0160ANEBH	3.5P	100	-	21	-	51	12	9	12	3	010	▽
G(BSP)	TCTR (tolerance)	 Hole Ø (mm)	Hole Ø (mm)	Code	THCHT (chamfer)	Basic major Ø (mm)	LF (mm)	THL (mm)	LS (mm)	DCON (mm)	K (mm)	LK (mm)	NOF	Type	Stock	
DIN 5156																
1/8-28	-	8.75	8.78	SVG0020NEBH	3.5P	9.728	90	19	46	7	5.5	8	3	010	▽	
1/4-19	-	11.75	11.78	SVG0040NEBH	3.5P	13.157	100	21	51	11	9	12	3	010	▽	
3/8-19	-	15.25	15.28	SVG0060NEBH	3.5P	16.662	100	21	51	12	9	12	3	010	▽	
1/2-14	-	19	19.04	SVG0080NEBH	3.5P	20.955	125	24	64	16	12	15	4	010	▽	

Intro

SP

DIN

SL

PO

ST

ROLL

CARBIDE

LONG

HAND
TAPS

EG (STI)

SPECIAL
THREADS,
GAUGESTHREAD
MILLS

DIES

CENTER
DRILLSTechnical
info

Intro

LO-SP OX

GP General Purpose Series

Low Spiral Fluted Taps, Oxided

SP

DIN

SL



PO

Recommended Tapping Speeds Depending On Materials

ISO	Vc (m/min)
P2	5÷10 ★
P3	5÷10 ★
P4	5÷10 ★

★ 1st choice ☆ suitable

ST

ROLL

CARBIDE

LONG

HAND TAPS

EG (STI)

SPECIAL THREADS, GAUGES

THREAD MILLS

DIES

CENTER DRILLS

Technical info



FEATURES

General purpose for blind hole application on medium tensile strength steel.

Low helix produces short chips. OX treatment reduces welding troubles.

Very suitable for horizontal tapping.

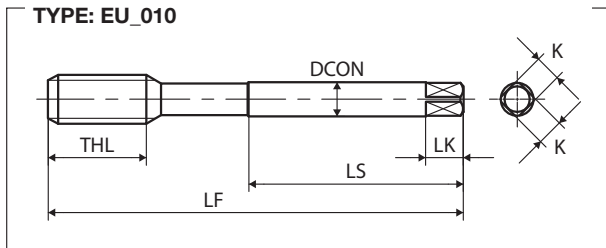
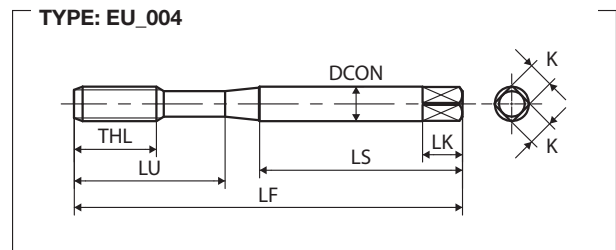
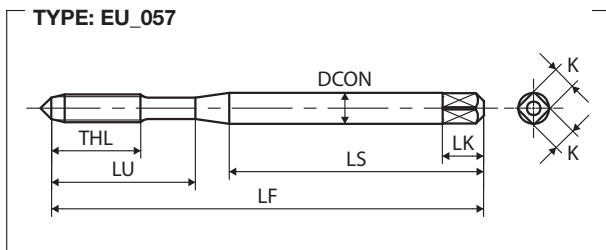

M	TCTR (tolerance)	Hole Ø (mm)	Hole Ø (mm)	Code	THCHT (chamfer)	LF (mm)	LT (mm)	THL (mm)	LU (mm)	LS (mm)	DCON (mm)	K (mm)	LK (mm)	NOF	Type	Stock
DIN 371																
M3X0.5	ISO2(6H)	2.5	2.56	SD3.0GANEXH	3.5P	56	-	9	18	34	3.5	2.7	6	2	057	●
M4X0.7	ISO2(6H)	3.3	3.38	SD4.0IANEXH	3.5P	63	-	13	21	38	4.5	3.4	6	3	057	●
M5X0.8	ISO2(6H)	4.2	4.28	SD5.0KANEXH	3.5P	70	-	14	25	39	6	4.9	8	3	057	●
M6X1	ISO2(6H)	5	5.09	SD6.0MANEXH	3.5P	80	-	15	30	45	6	4.9	8	3	057	●
M8X1.25	ISO2(6H)	6.8	6.85	SD8.0NANEXH	3.5P	90	-	19	35	47	8	6.2	9	3	004	●
M10X1.5	ISO2(6H)	8.5	8.6	SD0100ANEXH	3.5P	100	-	23	39	52	10	8	11	3	004	●

M	TCTR (tolerance)	 Hole Ø (mm)	Hole Ø (mm)	Code	THCHT (chamfer)	LF (mm)	LT (mm)	THL (mm)	LU (mm)	LS (mm)	DCON (mm)	K (mm)	LK (mm)	NOF	Type	Stock
DIN 376																
M12X1.75	ISO2(6H)	10.3	10.36	SG012PANEXH	3.5P	110	-	26	-	56	9	7	10	3	010	●
M14X2	ISO2(6H)	12	12.12	SG014QANEXH	3.5P	110	-	26	-	56	11	9	12	3	010	●
M16X2	ISO2(6H)	14	14.12	SG016QANEXH	3.5P	110	-	26	-	56	12	9	12	3	010	●
M18X2.5	ISO2(6H)	15.5	15.63	SG018RANEXH	3.5P	125	-	33	-	64	14	11	14	4	010	○
M20X2.5	ISO2(6H)	17.5	17.63	SG020RANEXH	3.5P	140	-	33	-	71	16	12	15	4	010	●
M22X2.5	ISO2(6H)	19.5	19.63	SG022RANEXH	3.5P	140	-	33	-	71	18	14.5	17	4	010	●
M24X3	ISO2(6H)	21	21.13	SG024SANEXH	3.5P	160	-	37	-	82	18	14.5	17	4	010	●
M27X3	ISO2(6H)	24	24.13	SG027SANEXH	3.5P	160	-	37	-	82	20	16	19	4	010	○
M30X3.5	ISO2(6H)	26.5	26.63	SG030TANEXH	3.5P	180	-	44	-	92	22	18	21	4	010	○

MF	TCTR (tolerance)	 Hole Ø (mm)	Hole Ø (mm)	Code	THCHT (chamfer)	LF (mm)	LT (mm)	THL (mm)	LU (mm)	LS (mm)	DCON (mm)	K (mm)	LK (mm)	NOF	Type	Stock
DIN 374																
M8X1	ISO2(6H)	7	7.09	SM8.0MANEXH	3.5P	90	-	19	-	46	6	4.9	8	3	010	●
M10X1.25	ISO2(6H)	8.8	8.85	SM010ANEXH	3.5P	100	-	23	-	51	7	5.5	8	3	010	●
M10X1	ISO2(6H)	9	9.09	SM010MANEXH	3.5P	90	-	19	-	46	7	5.5	8	3	010	●
M12X1.5	ISO2(6H)	10.5	10.6	SM0120ANEXH	3.5P	100	-	21	-	51	9	7	10	3	010	●
M12X1.25	ISO2(6H)	10.8	10.85	SM012NANEXH	3.5P	100	-	21	-	51	9	7	10	3	010	●
M12X1	ISO2(6H)	11	11.09	SM012MANEXH	3.5P	100	-	21	-	51	9	7	10	3	010	●
M14X1.5	ISO2(6H)	12.5	12.6	SM0140ANEXH	3.5P	100	-	21	-	51	11	9	12	3	010	●
M16X1.5	ISO2(6H)	14.5	14.6	SM0160ANEXH	3.5P	100	-	21	-	51	12	9	12	3	010	●
M18X1.5	ISO2(6H)	16.5	16.6	SM0180ANEXH	3.5P	110	-	24	-	56	14	11	14	4	010	●
M20X2	ISO2(6H)	18	18.12	SM020QANEXH	3.5P	140	-	33	-	71	16	12	15	4	010	○
M20X1.5	ISO2(6H)	18.5	18.6	SM0200ANEXH	3.5P	125	-	24	-	64	16	12	15	4	010	●
M22X1.5	ISO2(6H)	20.5	20.6	SM0220ANEXH	3.5P	125	-	24	-	64	18	14.5	17	4	010	●
M24X2	ISO2(6H)	22	22.12	SM024QANEXH	3.5P	140	-	27	-	71	18	14.5	17	4	010	●
M24X1.5	ISO2(6H)	22.5	22.6	SM0240ANEXH	3.5P	140	-	27	-	71	18	14.5	17	4	010	●
M25X1.5	ISO2(6H)	23.5	23.6	SM0250ANEXH	3.5P	140	-	27	-	71	18	14.5	17	4	010	○
M27X2	ISO2(6H)	25	25.12	SM027QANEXH	3.5P	140	-	27	-	71	20	16	19	4	010	●
M28X1.5	ISO2(6H)	26.5	26.6	SM0280ANEXH	3.5P	140	-	27	-	71	20	16	19	4	010	○
M30X2	ISO2(6H)	28	28.12	SM030QANEXH	3.5P	150	-	27	-	77	22	18	21	4	010	○
M30X1.5	ISO2(6H)	28.5	28.6	SM0300ANEXH	3.5P	150	-	27	-	77	22	18	21	4	010	●

G(BSP)	TCTR (tolerance)	 Hole Ø (mm)	Hole Ø (mm)	Code	THCHT (chamfer)	Basic major Ø (mm)	LF (mm)	THL (mm)	LS (mm)	DCON (mm)	K (mm)	LK (mm)	NOF	Type	Stock
DIN 5156															
1/8-28	-	8.75	8.78	SVG0020NEXH	3.5P	9.728	90	19	46	7	5.5	8	3	010	●
1/4-19	-	11.75	11.78	SVG0040NEXH	3.5P	13.157	100	21	51	11	9	12	3	010	●
3/8-19	-	15.25	15.28	SVG0060NEXH	3.5P	16.662	100	21	51	12	9	12	3	010	●
1/2-14	-	19	19.04	SVG0080NEXH	3.5P	20.955	125	24	64	16	12	15	4	010	●
3/4-14	-	24.5	24.52	SVG0120NEXH	3.5P	26.441	140	27	71	20	16	19	4	010	●
1-11	-	30.75	30.77	SVG0160NEXH	3.5P	33.249	160	29	82	25	20	23	4	010	○

DIES																
CENTER DRILLS																

Technical info

Intro
SP
DIN
SL
PO
ST
ROLL
CARBIDE
LONG
HAND TAPS
EG (STI)
SPECIAL THREADS, GAUGES
THREAD MILLS

Intro

AU+SP

MP Multi Purpose Series

Plus Series Spiral Fluted Taps, Coated

SP

DIN

SL



PO

Recommended Tapping Speeds Depending On Materials

ISO	Vc (m/min)	ISO	Vc (m/min)	ISO	Vc (m/min)	ISO	Vc (m/min)
P1	10÷20 ★	M1	5÷12 ★	K2	5÷15 ☆	N1	20÷30 ★
P2	10÷20 ★	M2	5÷10 ★			N2	20÷30 ★
P3	10÷20 ★					N3	10÷20 ☆
P4	10÷20 ★					N4	10÷20 ☆
P7	5÷12 ★						

★ 1st choice ☆ suitable

ST

ROLL

version **UP+** Product Features

CARBIDE

BLF (thread portion of special design) + proprietary flute design: Great improvement in chip ejection efficiency.

AU+SP has a special thread portion design with thread crests ground off and a few full threads after chamfer.

Effects of AU+SP are as follows:

- Prevention of chipping trouble at full thread portion
- Reduction of tapping torque and tapping friction
- Good chip ejection

LONG

HAND TAPS

EG (STI)

Change of marking position from shank into square portion

Laser marking can roughen the shank surface.

In order to keep high accuracy of shank circularity and diameter, marking has been transferred from shank to square portion.

SPECIAL THREADS, GAUGES

Wear resistance on a wide range of materials

AU+SP adopts a special flutes designed enabling coating features to show their best efficiency allowing high wear resistance on a wide range of work materials.

THREAD MILLS

M6×1

Work-material	42 CrMo 4 - 1.7225
Tapping length	9 mm, blind hole
Tapping speed	10 m/min
Hole diameter	ø 5.0
Machine	Vertical machining center
Lubricant	Water soluble oil (x 20)

DIES

CENTER DRILLS

Technical info



FEATURES

Multi purpose for blind hole application on a wide range of materials. High precision blanks and enhanced geometry allow top performance in term of thread accuracy and tool life.

BLF geometry reduces edge chipping trouble and improves chip ejection.

Suitable coating improves wear, heat and welding resistance.



WATCH THE VIDEO



BLF



chip ejection no trouble

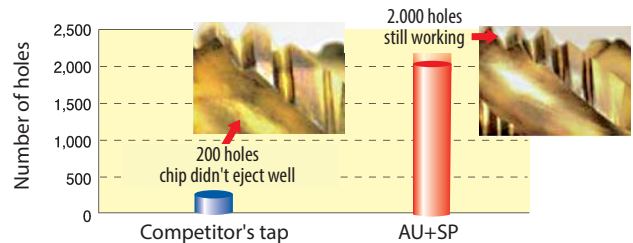

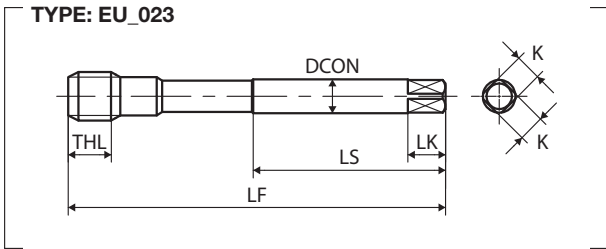
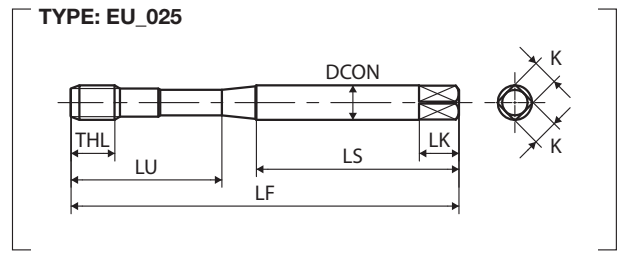
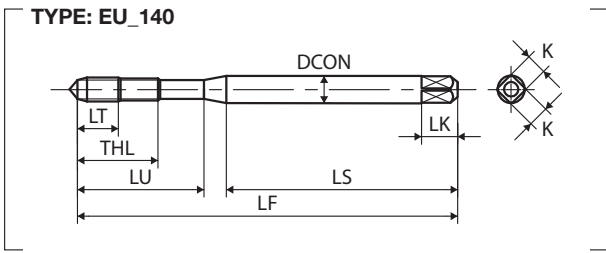

M	TCTR (tolerance)	∅ (mm)	Hole ∅ (mm)	Code	THCHT (chamfer)	LF (mm)	LT (mm)	THL (mm)	LU (mm)	LS (mm)	DCON (mm)	K (mm)	LK (mm)	NOF	Type	Stock
DIN 371																
M3X0.5	IS02(6H)	2.5	2.56	SE3.0GANEV	2.5P	56	-	9	18	34	3.5	2.7	6	3	140	●
M4X0.7	IS02(6H)	3.3	3.38	SE4.0IANEV	2.5P	63	-	13	21	38	4.5	3.4	6	3	140	●
M5X0.8	IS02(6H)	4.2	4.28	SE5.0KANEV	2.5P	70	-	14	25	39	6	4.9	8	3	140	●
M6X1	IS02(6H)	5	5.09	SE6.0MANEV	2.5P	80	-	15	30	45	6	4.9	8	3	140	●
M8X1.25	IS02(6H)	6.8	6.85	SE8.0NANEV	2.5P	90	-	19	35	47	8	6.2	9	3	025	●
M10X1.5	IS02(6H)	8.5	8.6	SE0100ANEV	2.5P	100	-	23	39	52	10	8	11	4	025	●

M	TCTR (tolerance)	∅ (mm)	Hole ∅ (mm)	Code	THCHT (chamfer)	LF (mm)	LT (mm)	THL (mm)	LU (mm)	LS (mm)	DCON (mm)	K (mm)	LK (mm)	NOF	Type	Stock
DIN 376																
M12X1.75	IS02(6H)	10.3	10.36	SH012PANEV	2.5P	110	-	26	-	56	9	7	10	4	023	●
M14X2	IS02(6H)	12	12.12	SH014QANEV	2.5P	110	-	26	-	56	11	9	12	4	023	●
M16X2	IS02(6H)	14	14.12	SH016QANEV	2.5P	110	-	26	-	56	12	9	12	4	023	●
M18X2.5	IS02(6H)	15.5	15.63	SH018RANEV	2.5P	125	-	33	-	64	14	11	14	4	023	●
M20X2.5	IS02(6H)	17.5	17.63	SH020RANEV	2.5P	140	-	33	-	71	16	12	15	4	023	●

MF	TCTR (tolerance)	∅ (mm)	Hole ∅ (mm)	Code	THCHT (chamfer)	LF (mm)	LT (mm)	THL (mm)	LU (mm)	LS (mm)	DCON (mm)	K (mm)	LK (mm)	NOF	Type	Stock
DIN 374																
M8X1	IS02(6H)	7	7.09	SN8.0MANEV	2.5P	90	-	19	-	46	6	4.9	8	3	023	●
M10X1.25	IS02(6H)	8.8	8.85	SN010NANEV	2.5P	100	-	23	-	51	7	5.5	8	4	023	●
M10X1	IS02(6H)	9	9.09	SN010MANEV	2.5P	90	-	19	-	46	7	5.5	8	4	023	●
M12X1.5	IS02(6H)	10.5	10.6	SN0120ANEV	2.5P	100	-	21	-	51	9	7	10	4	023	●
M12X1.25	IS02(6H)	10.8	10.85	SN012NANEV	2.5P	100	-	21	-	51	9	7	10	4	023	●
M14X1.5	IS02(6H)	12.5	12.6	SN0140ANEV	2.5P	100	-	21	-	51	11	9	12	4	023	●
M16X1.5	IS02(6H)	14.5	14.6	SN0160ANEV	2.5P	100	-	21	-	51	12	9	12	4	023	●
M18X1.5	IS02(6H)	16.5	16.6	SN0180ANEV	2.5P	110	-	24	-	56	14	11	14	4	023	●
M20X1.5	IS02(6H)	18.5	18.6	SN0200ANEV	2.5P	125	-	24	-	64	16	12	15	4	023	●

- Intro
- SP**
- DIN**
- SL
- PO
- ST
- ROLL
- CARBIDE
- LONG
- HAND TAPS
- EG (STI)
- SPECIAL THREADS, GAUGES
- THREAD MILLS
- DIES
- CENTER DRILLS
- Technical info

Intro

AUXSP

MP Multi Purpose Series

X Series Spiral Fluted Taps, Coated



SP

DIN

SL



PO

Recommended Tapping Speeds Depending On Materials

ISO	Vc (m/min)	★	ISO	Vc (m/min)	★	ISO	Vc (m/min)	☆	ISO	Vc (m/min)	★
P1	10÷25	★	M1	5÷15	★	K2	10÷25	☆	N1	20÷30	★
P2	10÷25	★	M2	5÷10	★				N2	20÷30	★
P3	10÷25	★							N3	15÷25	☆
P4	10÷25	★							N4	15÷25	☆
P7	5÷15	★									

★ 1st choice ☆ suitable

ST

ROLL

CARBIDE

LONG

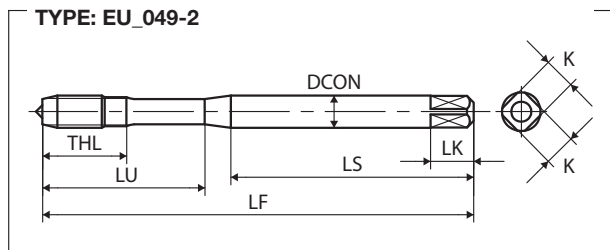

HAND TAPS

EG (STI)

SPECIAL THREADS, GAUGES

THREAD MILLS

DIES

CENTER DRILLS

Technical info

FEATURES

Multi purpose for blind hole application on a wide range of materials. High precision blanks and enhanced geometry allow top performance in term of thread accuracy and tool life.

BLF geometry reduces edge chipping trouble and improves chip ejection.

Suitable coating improves wear, heat and welding resistance.

This item will be gradually replaced by:

· VUSP page 80

M	TCTR (tolerance)	 Hole Ø (mm)	Hole Ø (mm)	Code	THCHT (chamfer)	LF (mm)	LT (mm)	THL (mm)	LU (mm)	LS (mm)	DCON (mm)	K (mm)	LK (mm)	NOF	Type	Stock
DIN YMW																
M6X1	IS02(6H)	5	5.09	SX6.0MANEV	2.5P	80	-	15	30	45	6	4.9	8	3	049-2	▽
M8X1.25	IS02(6H)	6.8	6.85	SX8.0NANEV	2.5P	90	-	19	35	48	8	6.2	9	3	049-2	▽
M10X1.5	IS02(6H)	8.5	8.6	SX0100ANEV	2.5P	100	-	23	39	53	10	8	11	4	049-2	▽
M12X1.75	IS02(6H)	10.3	10.36	SX012PANEV	2.5P	110	-	26	45	56	12	9	12	4	049-2	▽

Intro

SP

DIN

SL

PO

ST

ROLL

CARBIDE

LONG

HAND
TAPS

EG (STI)

SPECIAL
THREADS,
GAUGES

THREAD
MILLS

DIES

CENTER
DRILLS

Technical
info

Intro

PH-SP

MS Material Specific Series

Spiral Fluted Taps for Hard Materials (<35HRC)

SP

DIN

SL



PO

Recommended Tapping Speeds Depending On Materials

ISO Vc (m/min)

P3 5÷10 ☆

P4 2÷7 ★

P5 ≤5 ★

ST

★ 1st choice ☆ suitable

ROLL

CARBIDE

LONG

HAND TAPS

EG (STI)

SPECIAL THREADS, GAUGES

THREAD MILLS

DIES

CENTER DRILLS

Technical info



FEATURES

Material specific for blind hole application.

Specific design for medium-high tensile strength steel (<35HRC) application.

OX treatment reduces welding troubles.

TYPE: EU_140

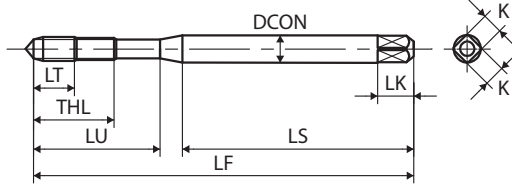

TYPE: EU_025

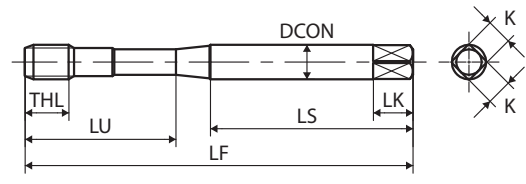

TYPE: EU_023

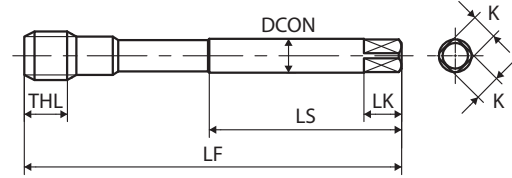

Intro
SP
DIN
 SL
 PO
 ST
 ROLL
 CARBIDE
 LONG
 HAND TAPS
 EG (STI)
 SPECIAL THREADS, GAUGES
 THREAD MILLS
 DIES
 CENTER DRILLS
 Technical info

M	TCTR (tolerance)	∅ (mm)	Hole ∅ (mm)	Code	THCHT (chamfer)	LF (mm)	LT (mm)	THL (mm)	LU (mm)	LS (mm)	DCON (mm)	K (mm)	LK (mm)	NOF	Type	Stock
DIN 371																
M3X0.5	IS02(6H)	2.5	2.56	SD3.0GAEEX	3P	56	5	9	18	34	3.5	2.7	6	3	140	●
M4X0.7	IS02(6H)	3.3	3.38	SD4.0IAEEX	3P	63	7	13	21	38	4.5	3.4	6	3	140	●
M5X0.8	IS02(6H)	4.2	4.28	SD5.0KAEEX	3P	70	9	14	25	39	6	4.9	8	3	140	●
M6X1	IS02(6H)	5	5.09	SD6.0MAEEX	3P	80	11	15	30	45	6	4.9	8	3	140	●
M8X1.25	IS02(6H)	6.8	6.85	SD8.0NAEEX	3P	90	-	12	35	47	8	6.2	9	3	025	●
M10X1.5	IS02(6H)	8.5	8.6	SD0100AEEX	3P	100	-	13	39	52	10	8	11	3	025	●

M	TCTR (tolerance)	∅ (mm)	Hole ∅ (mm)	Code	THCHT (chamfer)	LF (mm)	LT (mm)	THL (mm)	LU (mm)	LS (mm)	DCON (mm)	K (mm)	LK (mm)	NOF	Type	Stock
DIN 376																
M12X1.75	IS02(6H)	10.3	10.36	SG012PAEEX	3P	110	-	15	-	56	9	7	10	4	023	●
M14X2	IS02(6H)	12	12.12	SG014QAEEX	3P	110	-	18	-	56	11	9	12	4	023	●
M16X2	IS02(6H)	14	14.12	SG016QAEEX	3P	110	-	18	-	56	12	9	12	4	023	●
M18X2.5	IS02(6H)	15.5	15.63	SG018RAEEX	3P	125	-	20	-	64	14	11	14	4	023	●
M20X2.5	IS02(6H)	17.5	17.63	SG020RAEEX	3P	140	-	20	-	71	16	12	15	4	023	●
M22X2.5	IS02(6H)	19.5	19.63	SG022RAEEX	3P	140	-	20	-	71	18	14.5	17	5	023	●
M24X3	IS02(6H)	21	21.13	SG024SAEEX	3P	160	-	25	-	82	18	14.5	17	5	023	●
M27X3	IS02(6H)	24	24.13	SG027SAEEX	3P	160	-	25	-	82	20	16	19	5	023	●
M30X3.5	IS02(6H)	26.5	26.63	SG030TAEEX	3P	180	-	30	-	92	22	18	21	5	023	●

MF	TCTR (tolerance)	∅ (mm)	Hole ∅ (mm)	Code	THCHT (chamfer)	LF (mm)	LT (mm)	THL (mm)	LU (mm)	LS (mm)	DCON (mm)	K (mm)	LK (mm)	NOF	Type	Stock
DIN 374																
M8X1	IS02(6H)	7	7.09	SM8.0MAEEX	3P	90	-	12	-	46	6	4.9	8	3	023	●
M10X1.25	IS02(6H)	8.8	8.85	SM010NAEEX	3P	100	-	13	-	51	7	5.5	8	3	023	●
M10X1	IS02(6H)	9	9.09	SM010MAEEX	3P	90	-	13	-	46	7	5.5	8	3	023	●
M12X1.5	IS02(6H)	10.5	10.6	SM0120AEEX	3P	100	-	15	-	51	9	7	10	4	023	●
M12X1.25	IS02(6H)	10.8	10.85	SM012NAEEX	3P	100	-	15	-	51	9	7	10	4	023	●
M14X1.5	IS02(6H)	12.5	12.6	SM0140AEEX	3P	100	-	14	-	51	11	9	12	4	023	●
M16X1.5	IS02(6H)	14.5	14.6	SM0160AEEX	3P	100	-	14	-	51	12	9	12	4	023	●
M18X1.5	IS02(6H)	16.5	16.6	SM0180AEEX	3P	110	-	14	-	56	14	11	14	4	023	●
M20X1.5	IS02(6H)	18.5	18.6	SM0200AEEX	3P	125	-	14	-	64	16	12	15	4	023	●
M22X1.5	IS02(6H)	20.5	20.6	SM0220AEEX	3P	125	-	14	-	64	18	14.5	17	5	023	●
M24X2	IS02(6H)	22	22.12	SM024QAEEX	3P	140	-	18	-	71	18	14.5	17	5	023	●
M24X1.5	IS02(6H)	22.5	22.6	SM0240AEEX	3P	140	-	18	-	71	18	14.5	17	5	023	●
M27X2	IS02(6H)	25	25.12	SM027QAEEX	3P	140	-	20	-	71	20	16	19	5	023	●
M30X2	IS02(6H)	28	28.12	SM030QAEEX	3P	150	-	20	-	77	22	18	21	5	023	●
M30X1.5	IS02(6H)	28.5	28.6	SM0300AEEX	3P	150	-	20	-	77	22	18	21	5	023	○

G(BSP)	TCTR (tolerance)	∅ (mm)	Hole ∅ (mm)	Code	THCHT (chamfer)	Basic major ∅ (mm)	LF (mm)	THL (mm)	LS (mm)	DCON (mm)	K (mm)	LK (mm)	NOF	Type	Stock	
DIN 5156																
1/8-28	-	8.75	8.78	SVG0020EEX	3P	9.728	90	12	46	7	5.5	8	3	023	●	
1/4-19	-	11.75	11.78	SVG0040EEX	3P	13.157	100	14	51	11	9	12	4	023	●	
3/8-19	-	15.25	15.28	SVG0060EEX	3P	16.662	100	14	51	12	9	12	4	023	●	
1/2-14	-	19	19.04	SVG0080EEX	3P	20.955	125	18	64	16	12	15	4	023	●	

Intro

PM-SP

MS Material Specific Series

Spiral Fluted Taps for Hard Materials (<45HRC)

SP

DIN

SL



PO

Recommended Tapping Speeds Depending On Materials

ISO Vc (m/min)

P3 2÷10 ☆

P4 2÷7 ★

P5 2÷7 ★

P6 2÷5 ★

ST

★ 1st choice ☆ suitable

ROLL

CARBIDE

Product Features

ISO	Materials	Hardness	Recommended tapping speed (Vc <5m/min)	5m/min
P6	High tensile strength steel	40÷45 HRC	EH (HSS-Co)	
P5	Tool steel (100MnCrW4-1.2510 40CrMnMo7-1.2311)	30÷40 HRC	PM (HSS-P)	
P4	High alloy steel (CrMo, NiCrMo)	25÷30 HRC	PH (HSS-E)	

Most Suitable Suitable

SPECIAL
THREADS,
GAUGES

THREAD
MILLS

DIES

CENTER
DRILLS

Technical
info



FEATURES

Material specific for blind hole application.

Specific design and high class HSSP for stable and long life on alloy steel and tool steel (30 ÷ 45HRC) application.

Reliable and high performance tapping for the mould&die industry.

TYPE: EU_057

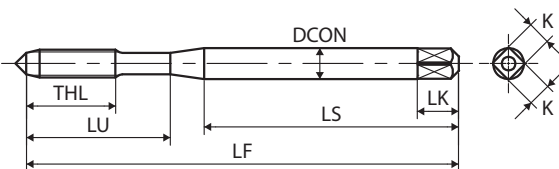

TYPE: EU_004

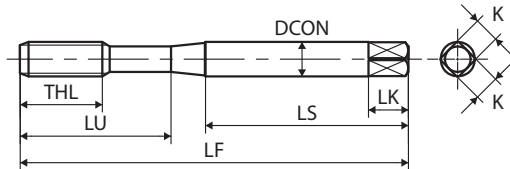

TYPE: EU_010

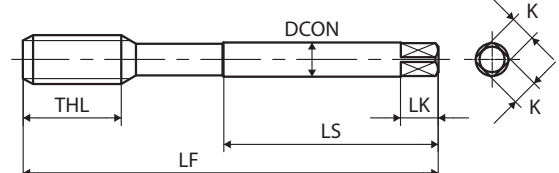

M	TCTR (tolerance)	 Hole Ø (mm)	Hole Ø (mm)	Code	THCHT (chamfer)	LF (mm)	LT (mm)	THL (mm)	LU (mm)	LS (mm)	DCON (mm)	K (mm)	LK (mm)	NOF	Type	Stock
DIN 371																
M3X0.5	ISO2X(6HX)	2.5	2.56	SD3.0GBDPB	2.75P	56	-	9	18	34	3.5	2.7	6	3	057	●
M4X0.7	ISO2X(6HX)	3.3	3.38	SD4.0IBDPB	2.75P	63	-	13	21	38	4.5	3.4	6	3	057	●
M5X0.8	ISO2X(6HX)	4.2	4.28	SD5.0KBDPB	2.75P	70	-	14	25	39	6	4.9	8	3	057	●
M6X1	ISO2X(6HX)	5	5.09	SD6.0MBDPB	2.75P	80	-	15	30	45	6	4.9	8	3	057	●
M8X1.25	ISO2X(6HX)	6.8	6.85	SD8.0NBDPB	2.75P	90	-	19	35	47	8	6.2	9	3	004	●
M10X1.5	ISO2X(6HX)	8.5	8.6	SD0100BDPB	2.75P	100	-	23	39	52	10	8	11	3	004	●
DIN 376																
M12X1.75	ISO2X(6HX)	10.3	10.36	SG012PBDPB	2.75P	110	-	26	-	56	9	7	10	3	010	●
M14X2	ISO2X(6HX)	12	12.12	SG014QBDPB	2.75P	110	-	26	-	56	11	9	12	3	010	●
M16X2	ISO2X(6HX)	14	14.12	SG016QBDPB	2.75P	110	-	26	-	56	12	9	12	3	010	●
M18X2.5	ISO2X(6HX)	15.5	15.63	SG018RBDPB	2.75P	125	-	33	-	64	14	11	14	4	010	●
M20X2.5	ISO2X(6HX)	17.5	17.63	SG020RBDPB	2.75P	140	-	33	-	71	16	12	15	4	010	●
M22X2.5	ISO2X(6HX)	19.5	19.63	SG022RBDPB	2.75P	140	-	33	-	71	18	14.5	17	4	010	●
M24X3	ISO2X(6HX)	21	21.13	SG024SBDPB	2.75P	160	-	37	-	82	18	14.5	17	4	010	●
M27X3	ISO2X(6HX)	24	24.13	SG027SBDPB	2.75P	160	-	37	-	82	20	16	19	4	010	●
M30X3.5	ISO2X(6HX)	26.5	26.63	SG030TBDPB	2.75P	180	-	44	-	92	22	18	21	4	010	●
DIN 374																
M8X1	ISO2X(6HX)	7	7.09	SM8.0MBDPB	2.75P	100	-	12	-	51	7	5.5	8	3	010	●
M10X1.25	ISO2X(6HX)	8.8	8.85	SM010NBDPB	2.75P	100	-	23	-	51	7	5.5	8	3	010	●
M10X1	ISO2X(6HX)	9	9.09	SM010MBDPB	2.75P	100	-	13	-	51	7	5.5	8	3	010	●
M12X1.5	ISO2X(6HX)	10.5	10.6	SM0120BDPB	2.75P	100	-	21	-	51	9	7	10	3	010	●
M12X1.25	ISO2X(6HX)	10.8	10.85	SM012NBDPB	2.75P	100	-	21	-	51	9	7	10	3	010	●
M14X1.5	ISO2X(6HX)	12.5	12.6	SM0140BDPB	2.75P	100	-	21	-	51	11	9	12	3	010	●
M16X1.5	ISO2X(6HX)	14.5	14.6	SM0160BDPB	2.75P	100	-	21	-	51	12	9	12	3	010	●
M18X1.5	ISO2X(6HX)	16.5	16.6	SM0180BDPB	2.75P	110	-	24	-	56	14	11	14	4	010	●
M20X1.5	ISO2X(6HX)	18.5	18.6	SM0200BDPB	2.75P	125	-	24	-	64	16	12	15	4	010	●
M22X1.5	ISO2X(6HX)	20.5	20.6	SM0220BDPB	2.75P	125	-	24	-	64	18	14.5	17	4	010	●
M24X2	ISO2X(6HX)	22	22.12	SM024QBDPB	2.75P	140	-	27	-	71	18	14.5	17	4	010	●
M24X1.5	ISO2X(6HX)	22.5	22.6	SM0240BDPB	2.75P	140	-	27	-	71	18	14.5	17	4	010	●
M27X2	ISO2X(6HX)	25	25.12	SM027QBDPB	2.75P	140	-	20	-	71	20	16	19	4	010	●
M27X1.5	ISO2X(6HX)	25.5	25.6	SM0270BDPB	2.75P	140	-	27	-	71	20	16	19	4	010	●
M30X2	ISO2X(6HX)	28	28.12	SM030QBDPB	2.75P	150	-	20	-	77	22	18	21	4	010	●
M30X1.5	ISO2X(6HX)	28.5	28.6	SM0300BDPB	2.75P	150	-	27	-	77	22	18	21	4	010	●

- Intro
- SP
- DIN
- SL
- PO
- ST
- ROLL
- CARBIDE
- LONG
- HAND TAPS
- EG (STI)
- SPECIAL THREADS, GAUGES
- THREAD MILLS
- DIES
- CENTER DRILLS
- Technical info

Intro

PMSP

MS Material Specific Series

Spiral Fluted Taps for Hard Materials (<45HRC)



SP

DIN

SL



PO

Recommended Tapping Speeds Depending On Materials

ISO	Vc (m/min)	
P3	≤5	☆
P4	≤5	★
P5	≤5	★
P6	≤5	★

★ 1st choice ☆ suitable

ST

ROLL

CARBIDE

Product Features

ISO	Materials	Hardness	Recommended tapping speed (Vc <5m/min)	5m/min
P6	High tensile strength steel	40÷45 HRC		
P5	Tool steel (100MnCrW4-1.2510, 40CrMnMo7-1.2311)	30÷40 HRC		
P4	High alloy steel (CrMo, NiCrMo)	25÷30 HRC		

Most Suitable (dashed red line) Suitable (solid red line)

LONG

HAND TAPS

EG (STI)

SPECIAL THREADS, GAUGES

Bored Hole Ø (mm) A - B

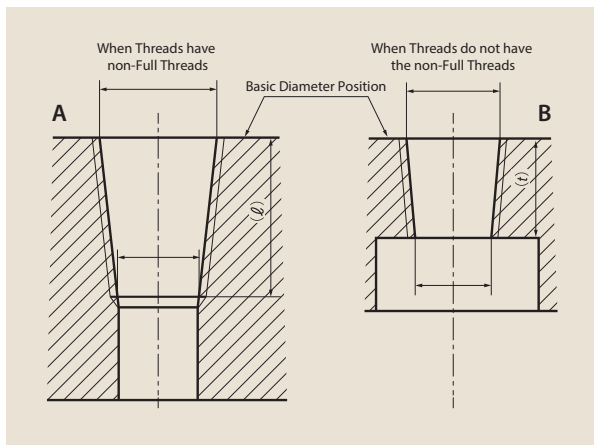

THREAD MILLS

DIES

CENTER DRILLS

Technical info

FEATURES

Material specific for blind hole application.
 Specific design and high class HSSP for stable and long life on alloy steel and tool steel (30 ÷ 45HRC) application.
 Reliable and high performance tapping for the mould&die industry.

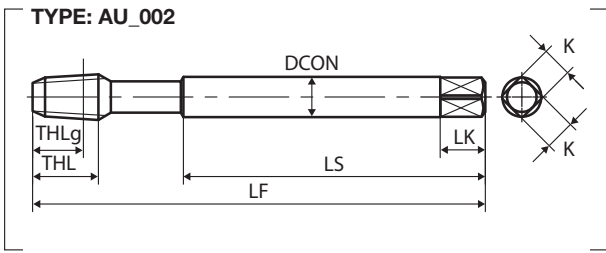

Rc(BSPT)	TCTR (tolerance)	Bored Hole Ø (mm)		Code	THCHT (chamfer)	Basic major Ø (mm)	LF (mm)	THL (mm)	THLg (mm)	LS (mm)	DCON (mm)	K (mm)	LK (mm)	NOF	Type	Stock
		A	B													
DIN YMW																
1/8-28	-	8.1	8.2	SJRC020DPX	2.5P	9.728	90	15	10.1	46	8	6	9	3	002	●
1/4-19	-	10.7	10.9	SJRC040DPX	2.5P	13.157	100	19	15	51	11	9	12	3	002	●
3/8-19	-	14.2	14.4	SJRC060DPX	2.5P	16.662	100	21	15.4	51	14	11	14	3	002	●
1/2-14	-	17.6	17.9	SJRC080DPX	2.5P	20.955	125	26	20.5	64	18	14	17	4	002	●
3/4-14	-	23	23.3	SJRC120DPX	2.5P	26.441	140	28	21.8	71	23	17	20	4	002	○
1 -11	-	29	29.3	SJRC160DPX	2.5P	33.249	160	33	26	82	26	21	24	4	002	○

Intro

SP

DIN

SL

PO

ST

ROLL

CARBIDE

LONG

HAND
TAPS

EG (STI)

SPECIAL
THREADS,
GAUGES

THREAD
MILLS

DIES

CENTER
DRILLS

Technical
info

Intro

SP+VA

MS Material Specific Series

Plus Series Spiral Fluted Taps for Stainless Steel



SP

DIN

SL



PO

Recommended Tapping Speeds Depending On Materials

ISO	Vc (m/min)	★	ISO	Vc (m/min)	★
P2	≤10	★	M1	≤10	★
P3	≤10	★			
P4	≤10	☆			
P7	≤10	★			

★ 1st choice ☆ suitable

ROLL

CARBIDE

version **UP+** Product Features

- Lower cutting torque due to special design
- Improved chip ejection and better thread finishing
- Increased tool life

LONG

M6×1

Work-material	AISI 304 - 1.4350
Tapping length	9 mm, blind hole
Tapping speed	8 m/min
Hole diameter	ø 5.0
Machine	Vertical machining center
Lubricant	Tapping oil

HAND TAPS

EG (STI)

SPECIAL THREADS, GAUGES

THREAD MILLS

DIES

CENTER DRILLS

Technical info

FEATURES

Material specific for blind hole application. High precision blank and enhanced geometry allow top performance in term of thread accuracy and tool life.

Most suitable for stainless steel, steel and alloy steel.

OX treatment reduces welding troubles.

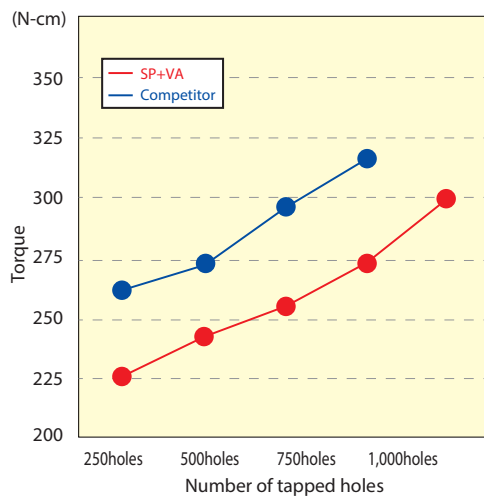
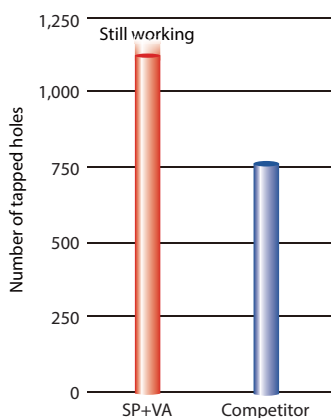
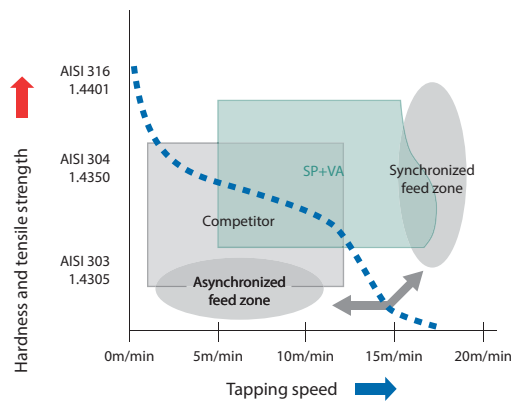

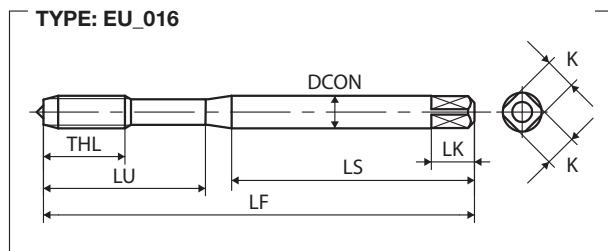
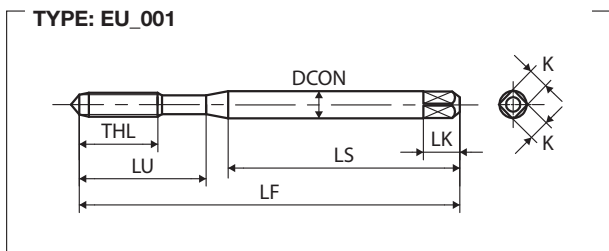

M	TCTR (tolerance)	Hole Ø (mm)	Hole Ø (mm)	Code	THCHT (chamfer)	LF (mm)	LT (mm)	THL (mm)	LU (mm)	LS (mm)	DCON (mm)	K (mm)	LK (mm)	NOF	Type	Stock
DIN 371																
M3X0.5	ISO2(6H)	2.5	2.56	SE3.0GAGEX	2.5P	56	-	9	18	34	3.5	2.7	6	3	001	●
M4X0.7	ISO2(6H)	3.3	3.38	SE4.0IAGEX	2.5P	63	-	13	21	38	4.5	3.4	6	3	001	●
M5X0.8	ISO2(6H)	4.2	4.28	SE5.0KAGEX	2.5P	70	-	14	25	39	6	4.9	8	3	001	●
M	TCTR (tolerance)	Hole Ø (mm)	Hole Ø (mm)	Code	THCHT (chamfer)	LF (mm)	LT (mm)	THL (mm)	LU (mm)	LS (mm)	DCON (mm)	K (mm)	LK (mm)	NOF	Type	Stock
DIN YMW																
M6X1	ISO2(6H)	5	5.09	SZ6.0MAGEX	2.5P	80	-	15	30	45	6	4.9	8	3	016	●
M8X1.25	ISO2(6H)	6.8	6.85	SZ8.0NAGEX	2.5P	90	-	19	35	48	8	6.2	9	3	016	●
M10X1.5	ISO2(6H)	8.5	8.6	SZ0100AGEX	2.5P	100	-	23	39	53	10	8	11	4	016	●
M12X1.75	ISO2(6H)	10.3	10.36	SZ012PAGEX	2.5P	110	-	26	45	56	12	9	12	4	016	●

Intro

SP
DIN

SL

PO

ST

ROLL

CARBIDE

LONG

HAND
TAPS

EG (STI)

SPECIAL
THREADS,
GAUGES

THREAD
MILLS

DIES

CENTER
DRILLS

Technical
info

Intro

SP-VA

MS Material Specific Series

Spiral Fluted Taps for Stainless Steel

SP

DIN

SL



PO

Recommended Tapping Speeds Depending On Materials

ISO	Vc (m/min)	★	ISO	Vc (m/min)	★
P2	≤10	★	M1	≤10	★
P3	≤10	★			
P4	≤10	☆			
P7	≤10	★			

★ 1st choice ☆ suitable

ST

ROLL

CARBIDE

LONG

HAND TAPS

EG (STI)

SPECIAL THREADS, GAUGES

THREAD MILLS

DIES

CENTER DRILLS

Technical info



FEATURES

Material specific for blind hole application.
Most suitable for stainless steel, steel and alloy steel.
OX treatment reduces welding troubles.

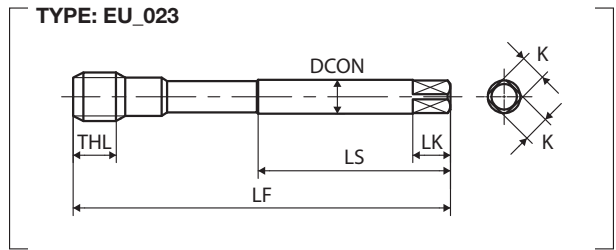
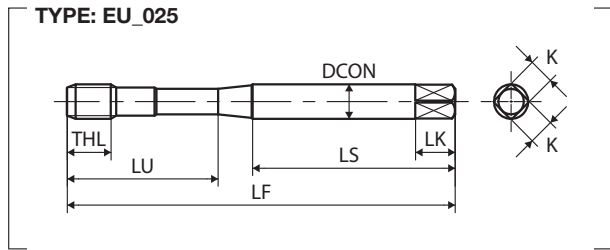
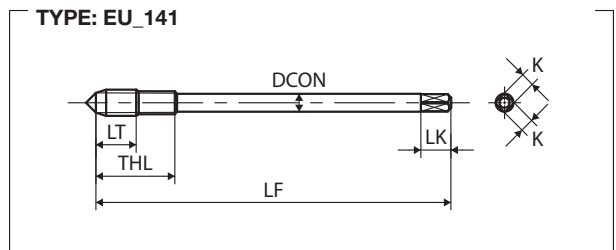
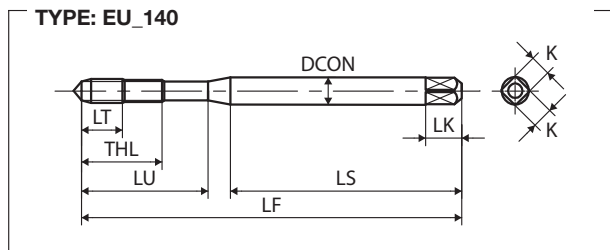

M	TCTR (tolerance)	\varnothing (mm)	Hole \varnothing (mm)	Code	THCHT (chamfer)	LF (mm)	LT (mm)	THL (mm)	LU (mm)	LS (mm)	DCON (mm)	K (mm)	LK (mm)	NOF	Type	Stock
DIN 371																
M2X0.4	ISO2(6H)	1.6	1.65	SD2.0EAGEX	2.5P	45	4	8	-	32	2.8	2.1	5	2	140	●
M2.5X0.45	ISO2(6H)	2.1	2.11	SD2.5FAGEX	2.5P	50	4	8	15	33	2.8	2.1	5	2	140	●
M3X0.5	ISO2(6H)	2.5	2.56	SD3.0GAGEX	2.5P	56	5	9	18	34	3.5	2.7	6	2	140	●
	ISO3(6G)	2.5	2.56	SD3.0GMGEX	2.5P	56	5	9	18	34	3.5	2.7	6	2	140	●
M4X0.7	ISO2(6H)	3.3	3.38	SD4.0IAGEX	2.5P	63	7	13	21	38	4.5	3.4	6	3	140	●
	ISO3(6G)	3.3	3.38	SD4.0IMGEX	2.5P	63	7	13	21	38	4.5	3.4	6	3	140	●
M5X0.8	ISO2(6H)	4.2	4.28	SD5.0KAGEX	2.5P	70	9	14	25	39	6	4.9	8	3	140	●
	ISO3(6G)	4.2	4.28	SD5.0KMGEX	2.5P	70	9	14	25	39	6	4.9	8	3	140	●
M6X1	ISO2(6H)	5	5.09	SD6.0MAGEX	2.5P	80	11	15	30	45	6	4.9	8	3	140	●
	ISO3(6G)	5	5.09	SD6.0MMGEX	2.5P	80	11	15	30	45	6	4.9	8	3	140	●
M8X1.25	ISO2(6H)	6.8	6.85	SD8.0NAGEX	2.5P	90	-	12	35	47	8	6.2	9	3	025	●
	ISO3(6G)	6.8	6.85	SD8.0NMGEX	2.5P	90	-	12	35	47	8	6.2	9	3	025	●
M10X1.5	ISO2(6H)	8.5	8.6	SD0100AGEX	2.5P	100	-	13	39	52	10	8	11	3	025	●
	ISO3(6G)	8.5	8.6	SD0100MGEX	2.5P	100	-	13	39	52	10	8	11	3	025	●

M	TCTR (tolerance)	\varnothing (mm)	Hole \varnothing (mm)	Code	THCHT (chamfer)	LF (mm)	LT (mm)	THL (mm)	LU (mm)	LS (mm)	DCON (mm)	K (mm)	LK (mm)	NOF	Type	Stock
DIN 376																
M8X1.25	ISO2(6H)	6.8	6.85	SG8.0NAGEX	2.5P	90	-	12	-	46	6	4.9	8	3	023	●
M10X1.5	ISO2(6H)	8.5	8.6	SG0100AGEX	2.5P	100	-	13	-	51	7	5.5	8	3	023	●
M12X1.75	ISO2(6H)	10.3	10.36	SG012PAGEX	2.5P	110	-	15	-	56	9	7	10	3	023	●
	ISO3(6G)	10.3	10.36	SG012PMGEX	2.5P	110	-	15	-	56	9	7	10	3	023	●
M14X2	ISO2(6H)	12	12.12	SG014QAGEX	2.5P	110	-	18	-	56	11	9	12	3	023	●
M16X2	ISO2(6H)	14	14.12	SG016QAGEX	2.5P	110	-	18	-	56	12	9	12	3	023	●
M18X2.5	ISO2(6H)	15.5	15.63	SG018RAGEX	2.5P	125	-	20	-	64	14	11	14	4	023	●
M20X2.5	ISO2(6H)	17.5	17.63	SG020RAGEX	2.5P	140	-	20	-	71	16	12	15	4	023	●
M22X2.5	ISO2(6H)	19.5	19.63	SG022RAGEX	2.5P	140	-	20	-	71	18	14.5	17	4	023	●
M24X3	ISO2(6H)	21	21.13	SG024SAGEX	2.5P	160	-	25	-	82	18	14.5	17	4	023	●
M27X3	ISO2(6H)	24	24.13	SG027SAGEX	2.5P	160	-	25	-	82	20	16	19	4	023	●
M30X3.5	ISO2(6H)	26.5	26.63	SG030TAGEX	2.5P	180	-	30	-	92	22	18	21	4	023	●
M36X4	ISO2(6H)	32	32.12	SG036UAGEX	2.5P	200	-	40	-	102	28	22	25	4	023	●

MF	TCTR (tolerance)	\varnothing (mm)	Hole \varnothing (mm)	Code	THCHT (chamfer)	LF (mm)	LT (mm)	THL (mm)	LU (mm)	LS (mm)	DCON (mm)	K (mm)	LK (mm)	NOF	Type	Stock
DIN 374																
M6X0.75	ISO2(6H)	5.3	5.33	SM6.0JAGEX	2.5P	80	13	13	-	-	4.5	3.4	6	3	141	●
M8X1	ISO2(6H)	7	7.09	SM8.0MAGEX	2.5P	90	-	12	-	46	6	4.9	8	3	023	●
M8X0.75	ISO2(6H)	7.3	7.33	SM8.0JAGEX	2.5P	80	-	12	-	41	6	4.9	8	3	023	●
M10X1.25	ISO2(6H)	8.8	8.85	SM010NAGEX	2.5P	100	-	13	-	51	7	5.5	8	3	023	●
M10X1	ISO2(6H)	9	9.09	SM010MAGEX	2.5P	90	-	13	-	46	7	5.5	8	3	023	●
M12X1.5	ISO2(6H)	10.5	10.6	SM012OAGEX	2.5P	100	-	15	-	51	9	7	10	3	023	●
M12X1.25	ISO2(6H)	10.8	10.85	SM012NAGEX	2.5P	100	-	15	-	51	9	7	10	3	023	●
M12X1	ISO2(6H)	11	11.09	SM012MAGEX	2.5P	100	-	15	-	51	9	7	10	3	023	●
M14X1.5	ISO2(6H)	12.5	12.6	SM014OAGEX	2.5P	100	-	14	-	51	11	9	12	3	023	●
M14X1	ISO2(6H)	13	13.09	SM014MAGEX	2.5P	100	-	14	-	51	11	9	12	3	023	●
M16X1.5	ISO2(6H)	14.5	14.6	SM016OAGEX	2.5P	100	-	14	-	51	12	9	12	3	023	●
M16X1	ISO2(6H)	15	15.09	SM016MAGEX	2.5P	100	-	14	-	51	12	9	12	3	023	●
M18X1.5	ISO2(6H)	16.5	16.6	SM018OAGEX	2.5P	110	-	14	-	56	14	11	14	4	023	●
M20X1.5	ISO2(6H)	18.5	18.6	SM020OAGEX	2.5P	125	-	14	-	64	16	12	15	4	023	●

SP
DIN

SL

PO

ST

ROLL

CARBIDE

LONG

HAND
TAPS

EG (STI)

SPECIAL
THREADS,
GAUGESTHREAD
MILLS

DIES

CENTER
DRILLSTechnical
info

Spiral Fluted Taps

Intro

MF	TCTR (tolerance)	 Hole Ø (mm)	Hole Ø (mm)	Code	THCHT (chamfer)	LF (mm)	LT (mm)	THL (mm)	LU (mm)	LS (mm)	DCON (mm)	K (mm)	LK (mm)	NOF	Type	Stock
DIN 374																
M22X1.5	IS02(6H)	20.5	20.6	SM0220AGEX	2.5P	125	-	14	-	64	18	14.5	17	4	023	●
M24X2	IS02(6H)	22	22.12	SM024QAGEX	2.5P	140	-	18	-	71	18	14.5	17	4	023	●
M24X1.5	IS02(6H)	22.5	22.6	SM0240AGEX	2.5P	140	-	18	-	71	18	14.5	17	4	023	●
M27X2	IS02(6H)	25	25.12	SM027QAGEX	2.5P	140	-	20	-	71	20	16	19	4	023	●
M30X2	IS02(6H)	28	28.12	SM030QAGEX	2.5P	150	-	20	-	77	22	18	21	4	023	●
M30X1.5	IS02(6H)	28.5	28.6	SM0300AGEX	2.5P	150	-	20	-	77	22	18	21	4	023	●

SP

DIN

SL

PO

ST

ROLL

UNC	TCTR (tolerance)	 Hole Ø (mm)	Hole Ø (mm)	Code	THCHT (chamfer)	LF (mm)	LT (mm)	THL (mm)	LU (mm)	LS (mm)	DCON (mm)	K (mm)	LK (mm)	NOF	Type	Stock
DIN 371																
No.4-40UNC	2B	2.3	2.33	SDUN4HXGEX	2.5P	56	5	9	18	34	3.5	2.7	6	2	140	●
No.6-32UNC	2B	2.8	2.83	SDUN6JXGEX	2.5P	56	7	11	19	32	4	3	6	3	140	●
No.8-32UNC	2B	3.4	3.47	SDUN8JXGEX	2.5P	63	7	13	21	38	4.5	3.4	6	3	140	●
No.10-24UNC	2B	3.89	3.9	SDUNAMXGEX	2.5P	70	9	14	24	39	6	4.9	8	3	140	●
1/4-20UNC	2B	5.1	5.19	SDU04NXGEX	2.5P	80	11	15	30	42	7	5.5	8	3	140	●
5/16-18UNC	2B	6.6	6.65	SDU050XGEX	2.5P	90	-	12	35	47	8	6.2	9	3	025	●
3/8-16UNC	2B	8	8.07	SDU06PXGEX	2.5P	100	-	13	39	54	9	7	10	3	025	●

CARBIDE

LONG

HAND TAPS

UNC	TCTR (tolerance)	 Hole Ø (mm)	Hole Ø (mm)	Code	THCHT (chamfer)	LF (mm)	LT (mm)	THL (mm)	LU (mm)	LS (mm)	DCON (mm)	K (mm)	LK (mm)	NOF	Type	Stock
DIN 376																
7/16-14UNC	2B	9.4	9.45	SGU07QXGEX	2.5P	100	-	13	-	51	8	6.2	9	3	023	●
1/2-13UNC	2B	10.9	10.91	SGU08RXGEX	2.5P	110	-	15	-	56	9	7	10	3	023	●
9/16-12UNC	2B	12.2	12.33	SGU09SXGEX	2.5P	110	-	18	-	56	11	9	12	3	023	●
5/8-11UNC	2B	13.6	13.75	SGU10UXGEX	2.5P	110	-	18	-	56	12	9	12	3	023	●
3/4-10UNC	2B	16.6	16.7	SGU12VXGEX	2.5P	125	-	20	-	64	14	11	14	4	023	●
7/8-9UNC	2B	19.6	19.61	SGU14WXGEX	2.5P	140	-	20	-	71	18	14.5	17	4	023	●
1-8UNC	2B	22.3	22.45	SGU16XXGEX	2.5P	160	-	25	-	82	18	14.5	17	4	023	●
1 1/8-7UNC	2B	25	25.17	SGU18YXGEX	2.5P	180	-	30	-	92	22	18	21	4	023	●
1 1/4-7UNC	2B	28.2	28.35	SGU20YXGEX	2.5P	180	-	30	-	92	22	18	21	4	023	●
1 3/8-6UNC	2B	30.8	30.92	SGU22ZXGEX	2.5P	200	-	40	-	102	28	22	25	4	023	●
1 1/2-6UNC	2B	34	34.1	SGU24ZXGEX	2.5P	200	-	40	-	102	32	24	27	4	023	●

EG (STI)

SPECIAL THREADS, GAUGES

THREAD MILLS

DIES

CENTER DRILLS

UNF	TCTR (tolerance)	 Hole Ø (mm)	Hole Ø (mm)	Code	THCHT (chamfer)	LF (mm)	LT (mm)	THL (mm)	LU (mm)	LS (mm)	DCON (mm)	K (mm)	LK (mm)	NOF	Type	Stock
DIN 371																
No.10-32UNF	2B	4.1	4.12	SDUNAJXGEX	2.5P	70	9	14	24	39	6	4.9	8	3	140	●
1/4-28UNF	2B	5.5	5.53	SDU04KXGEX	2.5P	80	11	15	30	42	7	5.5	8	3	140	●
DIN 374																
5/16-24UNF	2B	6.9	6.97	SMU05MXGEX	2.5P	90	-	12	-	46	6	4.9	8	3	023	●
3/8-24UNF	2B	8.5	8.57	SMU06MXGEX	2.5P	100	-	13	-	51	7	5.5	8	3	023	●
7/16-20UNF	2B	9.9	9.96	SMU07NXGEX	2.5P	100	-	13	-	51	8	6.2	9	3	023	●
1/2-20UNF	2B	11.5	11.54	SMU08NXGEX	2.5P	100	-	15	-	51	9	7	10	3	023	●
9/16-18UNF	2B	12.9	13	SMU090XGEX	2.5P	100	-	14	-	51	11	9	12	3	023	●
5/8-18UNF	2B	14.5	14.6	SMU100XGEX	2.5P	100	-	14	-	51	12	9	12	3	023	●
3/4-16UNF	2B	17.5	17.59	SMU12PXGEX	2.5P	110	-	14	-	56	14	11	14	4	023	●
7/8-14UNF	2B	20.5	20.57	SMU14QXGEX	2.5P	125	-	20	-	64	18	14.5	17	4	023	●
1-12UNF	2B	23.3	23.46	SMU16SXGEX	2.5P	140	-	18	-	71	18	14.5	17	4	023	●

Technical info

UNF	TCTR (tolerance)	 Hole Ø (mm)	Hole Ø (mm)	Code	THCHT (chamfer)	LF (mm)	LT (mm)	THL (mm)	LU (mm)	LS (mm)	DCON (mm)	K (mm)	LK (mm)	NOF	Type	Stock
DIN 374																
1 1/8-12UNF	2B	26.5	26.63	SMU18SXGEX	2.5P	150	-	20	-	77	22	18	21	4	023	●
1 1/4-12UNF	2B	29.6	29.81	SMU20SXGEX	2.5P	150	-	20	-	77	22	18	21	4	023	●
1 3/8-12UNF	2B	32.8	32.98	SMU22SXGEX	2.5P	170	-	20	-	87	28	22	25	4	023	●
1 1/2-12UNF	2B	36	36.16	SMU24SXGEX	2.5P	170	-	20	-	87	32	24	27	4	023	●
8UN																
DIN 374																
1 1/8-8UN	2B	25.5	25.62	SMU18XXGEX	2.5P	180	-	28	-	92	22	18	21	4	023	●
1 1/4-8UN	2B	28.5	28.8	SMU20XXGEX	2.5P	180	-	28	-	92	22	18	21	4	023	●
1 3/8-8UN	2B	31.8	31.97	SMU22XXGEX	2.5P	200	-	30	-	102	28	22	25	4	023	●
1 1/2-8UN	2B	35	35.15	SMU24XXGEX	2.5P	200	-	30	-	102	32	24	27	4	023	●
1 5/8-8UN	2B	38.1	38.32	SMU26XXGEX	2.5P	200	-	30	-	102	32	24	27	4	023	●
1 3/4-8UN	2B	41.3	41.5	SMU28XXGEX	2.5P	200	-	40	-	102	36	29	32	4	023	●
2 -8UN	2B	47.8	47.85	SMU32XXGEX	2.5P	225	-	40	-	115	40	32	35	4	023	●
G(BSP)																
DIN 5156																
1/8-28	-	8.75	8.78	SVG0020GEX	2.5P	9.728	90	12	46	7	5.5	8	3	023	●	
1/4-19	-	11.75	11.78	SVG0040GEX	2.5P	13.157	100	14	51	11	9	12	3	023	●	
3/8-19	-	15.25	15.28	SVG0060GEX	2.5P	16.662	100	14	51	12	9	12	3	023	●	
1/2-14	-	19	19.04	SVG0080GEX	2.5P	20.955	125	18	64	16	12	15	4	023	●	
3/4-14	-	24.5	24.52	SVG0120GEX	2.5P	26.441	140	20	71	20	16	19	4	023	●	
1 -11	-	30.75	30.77	SVG0160GEX	2.5P	33.249	160	20	82	25	20	23	4	023	●	

- Intro
- SP**
- DIN**
- SL
- PO
- ST
- ROLL
- CARBIDE
- LONG
- HAND TAPS
- EG (STI)
- SPECIAL THREADS, GAUGES
- THREAD MILLS
- DIES
- CENTER DRILLS
- Technical info

Intro

SP-VA TiCN

MS Material Specific Series

Spiral Fluted Taps for Stainless Steel, Coated

SP

DIN

SL



PO

Recommended Tapping Speeds Depending On Materials

ISO	Vc (m/min)	★	ISO	Vc (m/min)	★
P2	≤15	★	M1	≤15	★
P3	≤15	★			
P4	≤15	☆			
P7	≤15	★			

★ 1st choice ☆ suitable

ST

ROLL

CARBIDE

LONG

HAND TAPS

EG (STI)

SPECIAL THREADS, GAUGES

THREAD MILLS

DIES

CENTER DRILLS

Technical info





FEATURES

Material specific for blind hole application.
Most suitable for stainless steel, steel and alloy steel.
Suitable coating improves wear, heat and welding resistance.

This item will be gradually replaced by:

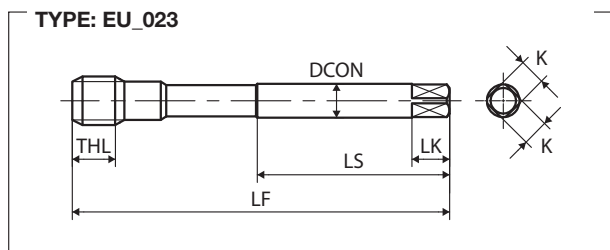
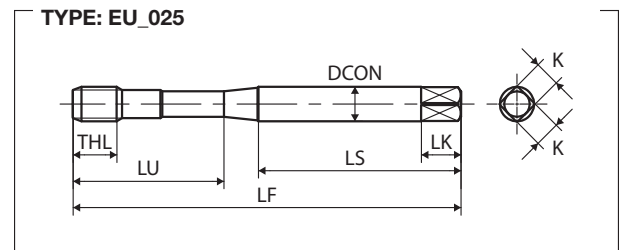
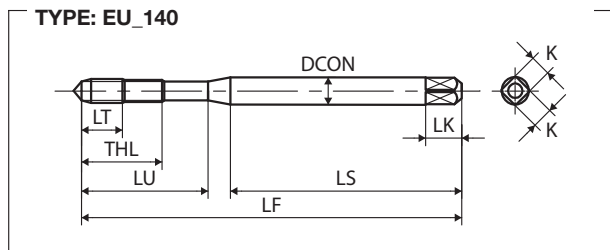
· VUSP page 80



M	TCTR (tolerance)	 Hole Ø (mm)	Hole Ø (mm)	Code	THCHT (chamfer)	LF (mm)	LT (mm)	THL (mm)	LU (mm)	LS (mm)	DCON (mm)	K (mm)	LK (mm)	NOF	Type	Stock
DIN 371																
M3X0.5	IS02(6H)	2.5	2.56	SD3.0GAGET	2.5P	56	5	9	18	34	3.5	2.7	6	2	140	▽
M4X0.7	IS02(6H)	3.3	3.38	SD4.0IAGET	2.5P	63	7	13	21	38	4.5	3.4	6	3	140	▽
M5X0.8	IS02(6H)	4.2	4.28	SD5.0KAGET	2.5P	70	9	14	25	39	6	4.9	8	3	140	▽
M6X1	IS02(6H)	5	5.09	SD6.0MAGET	2.5P	80	11	15	30	45	6	4.9	8	3	140	▽
M8X1.25	IS02(6H)	6.8	6.85	SD8.0NAGET	2.5P	90	-	12	35	47	8	6.2	9	3	025	▽
M10X1.5	IS02(6H)	8.5	8.6	SD010OAGET	2.5P	100	-	13	39	52	10	8	11	3	025	▽
DIN 376																
M12X1.75	IS02(6H)	10.3	10.36	SG012PAGET	2.5P	110	-	15	-	56	9	7	10	3	023	▽
M14X2	IS02(6H)	12	12.12	SG014QAGET	2.5P	110	-	18	-	56	11	9	12	3	023	▽
M16X2	IS02(6H)	14	14.12	SG016QAGET	2.5P	110	-	18	-	56	12	9	12	3	023	▽
M20X2.5	IS02(6H)	17.5	17.63	SG020RAGET	2.5P	140	-	18	-	71	16	12	15	4	023	▽

Intro

SP

DIN

SL

PO

ST

ROLL

CARBIDE

LONG

HAND
TAPS

EG (STI)

SPECIAL
THREADS,
GAUGESTHREAD
MILLS

DIES

CENTER
DRILLSTechnical
info

Intro

SU2-SP



SP

MS Material Specific Series

Spiral Fluted Taps for Tough Stainless Steel

DIN



SL

PO

Recommended Tapping Speeds Depending On Materials

ISO	Vc (m/min)	ISO	Vc (m/min)	ISO	Vc (m/min)
P1		M1	5÷15 ☆	S1	3÷7 ☆
P2		M2	5÷15 ★		
P3		M3	5÷12 ★		
P4					
P5					
P7					

★ 1st choice ☆ suitable

ST

ROLL

CARBIDE

Product Features

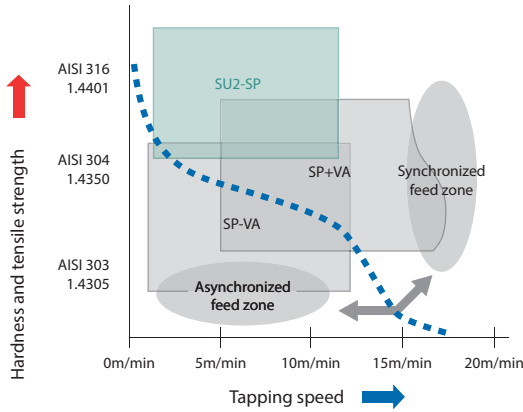

LONG

HAND TAPS

EG (STI)

Tapping Data

Work-material	AISI316 - 1.4401
Tapping length	25 mm, blind hole
Tapping speed	8 m/min
Hole diameter	ø 10.3
Machine	CNC tapping machine
Lubricant	Tapping oil

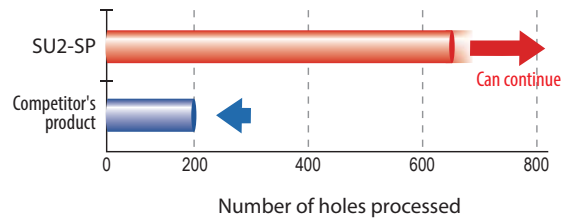

FEATURES

Material specific for blind hole application.
Most suitable for tough stainless steel (ISO M2 - M3).
OX treatment reduces welding troubles, BLF geometry improves chip ejection.

DIES

CENTER DRILLS

Technical info

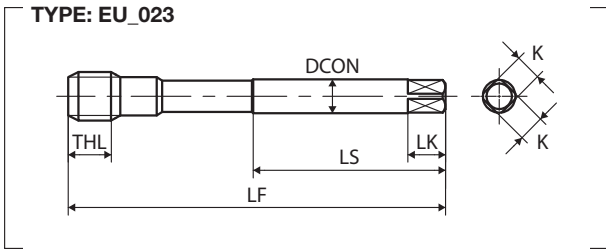
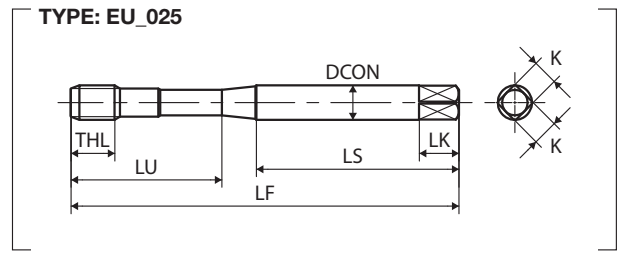
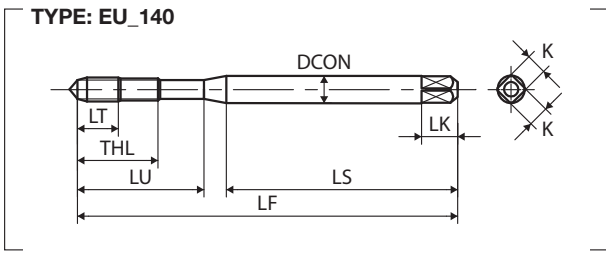

M	TCTR (tolerance)	∅ (mm)	Hole ∅ (mm)	Code	THCHT (chamfer)	LF (mm)	LT (mm)	THL (mm)	LU (mm)	LS (mm)	DCON (mm)	K (mm)	LK (mm)	NOF	Type	Stock
DIN 371																
M3X0.5	IS02(6H)	2.5	2.56	SD3.0GAGEXJ	2.5P	56	-	9	18	34	3.5	2.7	6	3	140	●
M4X0.7	IS02(6H)	3.3	3.38	SD4.0IAGEXJ	2.5P	63	-	13	21	38	4.5	3.4	6	3	140	●
M5X0.8	IS02(6H)	4.2	4.28	SD5.0KAGEXJ	2.5P	70	-	14	25	39	6	4.9	8	3	140	●
M6X1	IS02(6H)	5	5.09	SD6.0MAGEXJ	2.5P	80	-	15	30	45	6	4.9	8	3	140	●
M8X1.25	IS02(6H)	6.8	6.85	SD8.0NAGEXJ	2.5P	90	-	19	35	47	8	6.2	9	3	025	●
M10X1.5	IS02(6H)	8.5	8.6	SD0100AGEXJ	2.5P	100	-	23	39	52	10	8	11	3	025	●

M	TCTR (tolerance)	∅ (mm)	Hole ∅ (mm)	Code	THCHT (chamfer)	LF (mm)	LT (mm)	THL (mm)	LU (mm)	LS (mm)	DCON (mm)	K (mm)	LK (mm)	NOF	Type	Stock
DIN 376																
M12X1.75	IS02(6H)	10.3	10.36	SG012PAGEXJ	2.5P	110	-	26	-	56	9	7	10	4	023	●
M14X2	IS02(6H)	12	12.12	SG014QAGEXJ	2.5P	110	-	26	-	56	11	9	12	4	023	●
M16X2	IS02(6H)	14	14.12	SG016QAGEXJ	2.5P	110	-	26	-	56	12	9	12	4	023	●
M18X2.5	IS02(6H)	15.5	15.63	SG018RAGEXJ	2.5P	125	-	33	-	64	14	11	14	4	023	●
M20X2.5	IS02(6H)	17.5	17.63	SG020RAGEXJ	2.5P	140	-	33	-	71	16	12	15	4	023	●
M22X2.5	IS02(6H)	19.5	19.63	SG022RAGEXJ	2.5P	140	-	33	-	71	18	14.5	17	4	023	○
M24X3	IS02(6H)	21	21.13	SG024SAGEXJ	2.5P	160	-	37	-	82	18	14.5	17	4	023	●

G(BSP)	TCTR (tolerance)	∅ (mm)	Hole ∅ (mm)	Code	THCHT (chamfer)	Basic major ∅ (mm)	LF (mm)	THL (mm)	LS (mm)	DCON (mm)	K (mm)	LK (mm)	NOF	Type	Stock
DIN 5156															
1/8-28	-	8.75	8.78	SVG0020GEXJ	2.5P	9.728	90	19	46	7	5.5	8	3	023	●
1/4-19	-	11.75	11.78	SVG0040GEXJ	2.5P	13.157	100	21	51	11	9	12	4	023	●
3/8-19	-	15.25	15.28	SVG0060GEXJ	2.5P	16.662	100	21	51	12	9	12	4	023	●
1/2-14	-	19	19.04	SVG0080GEXJ	2.5P	20.955	125	24	64	16	12	15	4	023	●
3/4-14	-	24.5	24.52	SVG0120GEXJ	2.5P	26.441	140	27	71	20	16	19	4	023	●

Intro

SP

DIN

SL

PO

ST

ROLL

CARBIDE

LONG

HAND TAPS

EG (STI)

SPECIAL THREADS, GAUGES

THREAD MILLS

DIES

CENTER DRILLS

Technical info

Intro

AL+SP/AL-SP



SP

MS Material Specific Series

Spiral Fluted Taps for Aluminium

DIN



SL

PO

Recommended Tapping Speeds Depending On Materials

ISO	Vc (m/min)
N1	10÷25 ★
N2	10÷25 ★
N3	10÷25 ★
N4	10÷25 ★

★ 1st choice ☆ suitable

ST

ROLL

Product Features

CARBIDE

AL+SP guarantees consistent tapping even in medium-high speed cutting area, in forged workpieces of light alloys such as aluminum die castings and aluminum castings.

Featuring an optimized cutting edge design, AL+SP does not produce burrs in minor diameter which usually occurs during tapping light alloys. AL+SP ensure reliability and high quality internal threads.

LONG

Process Data

M6×1

Work-material	DIN G-AISI7Mg
Tapping length	9mm, blind hole
Tapping speed	20 m/min
Hole diameter	ø 5.0
Machine	Vertical machining center
Lubricant	Water soluble oil (x 20)

HAND TAPS

EG (STI)

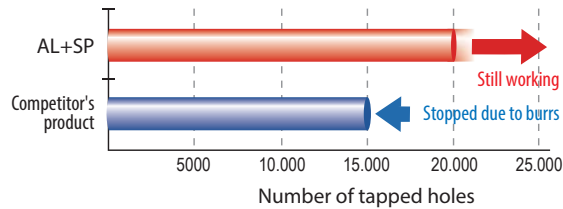

SPECIAL THREADS, GAUGES

AL+SP

Internal thread

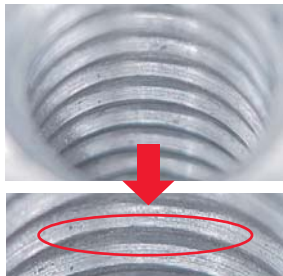

Cross section of internal threads

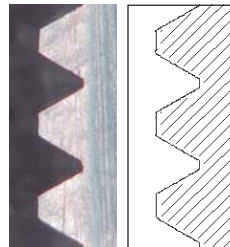

THREAD MILLS

DIES

Competitor

Internal thread

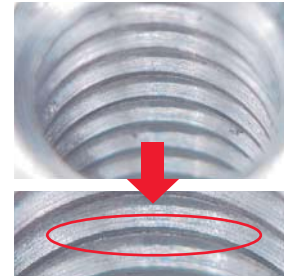

Cross section of internal threads

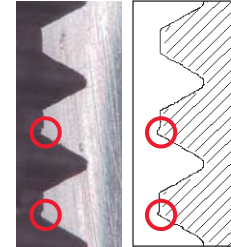

CENTER DRILLS

Compared to competitor, AL+SP assures longer tool life and higher quality internal threads

Technical info

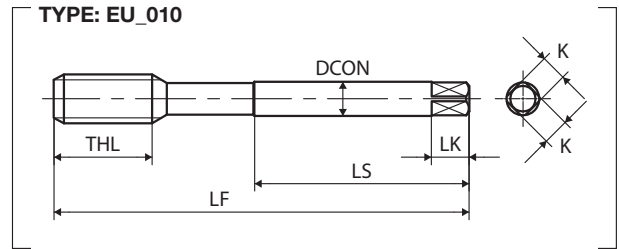
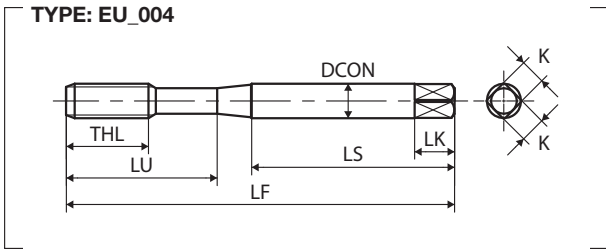
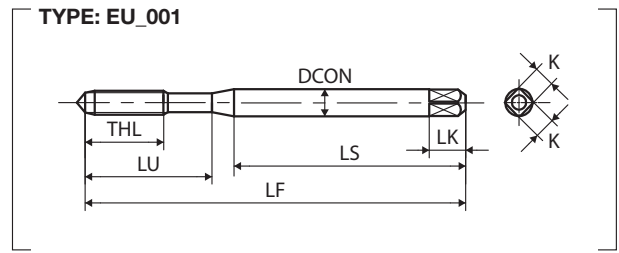
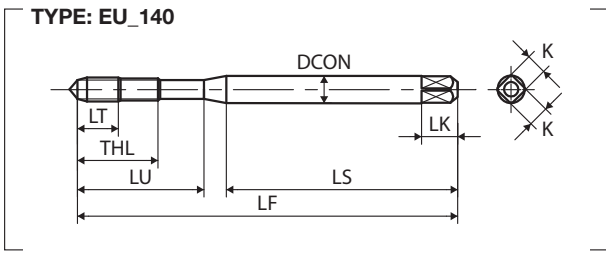

M	TCTR (tolerance)	\varnothing (mm)	Hole \varnothing (mm)	Code	THCHT (chamfer)	LF (mm)	LT (mm)	THL (mm)	LU (mm)	LS (mm)	DCON (mm)	K (mm)	LK (mm)	NOF	Type	Stock
DIN 371																
M2X0.4	IS02(6H)	1.6	1.65	SE2.0EALEN	2.5P	45	-	8	-	-	2.8	2.1	5	2	140	●
M2.5X0.45	IS02(6H)	2.1	2.11	SE2.5FALEN	2.5P	50	-	8	15	33	2.8	2.1	5	2	001	●
M3X0.5	IS02(6H)	2.5	2.56	SE3.0GALEN	2.5P	56	-	9	18	34	3.5	2.7	6	3	001	●
M4X0.7	IS02(6H)	3.3	3.38	SE4.0IALEN	2.5P	63	-	13	21	38	4.5	3.4	6	3	001	●
M5X0.8	IS02(6H)	4.2	4.28	SE5.0KALEN	2.5P	70	-	14	25	39	6	4.9	8	3	001	●
M6X1	IS02(6H)	5	5.09	SE6.0MALEN	2.5P	80	-	15	30	45	6	4.9	8	3	001	●
M8X1.25	IS02(6H)	6.8	6.85	SD8.0NALEN	2.5P	90	-	19	35	47	8	6.2	9	3	004	●
M10X1.5	IS02(6H)	8.5	8.6	SD0100ALEN	2.5P	100	-	23	39	52	10	8	11	3	004	●
M	TCTR (tolerance)	\varnothing (mm)	Hole \varnothing (mm)	Code	THCHT (chamfer)	LF (mm)	LT (mm)	THL (mm)	LU (mm)	LS (mm)	DCON (mm)	K (mm)	LK (mm)	NOF	Type	Stock
DIN 376																
M12X1.75	IS02(6H)	10.3	10.36	SG012PALEN	2.5P	110	-	26	-	56	9	7	10	3	010	●
M14X2	IS02(6H)	12	12.12	SG014QALEN	2.5P	110	-	26	-	56	11	9	12	3	010	●
M16X2	IS02(6H)	14	14.12	SG016QALEN	2.5P	110	-	26	-	56	12	9	12	3	010	●

- Intro
- SP**
- DIN**
- SL
- PO
- ST
- ROLL
- CARBIDE
- LONG
- HAND TAPS
- EG (STI)
- SPECIAL THREADS, GAUGES
- THREAD MILLS
- DIES
- CENTER DRILLS
- Technical info

Intro

ZEN-B



MS Material Specific Series

Spiral Fluted Taps for Nickel Base Alloys

SP

DIN

SL



PO

Recommended Tapping Speeds Depending On Materials

ISO	Vc (m/min)	ISO	Vc (m/min)	ISO	Vc (m/min)
P1		M1	5÷15 ★	S1	5÷10 ★
P2		M2	5÷15 ★	S2	5÷10 ★
P3	5÷15 ★	M3	4÷8 ★		
P4	5÷15 ★				
P5	5÷10 ☆				
P7	5÷15 ★				
P8	4÷8 ★				

★ 1st choice ☆ suitable

FEATURES

Material specific for blind hole application.
 Specific design and OX treatment allow high performance on Nickel base alloys.
 Also suitable for stainless steel and high alloy steel.

CARBIDE

LONG

HAND TAPS

EG (STI)

SPECIAL THREADS, GAUGES

THREAD MILLS





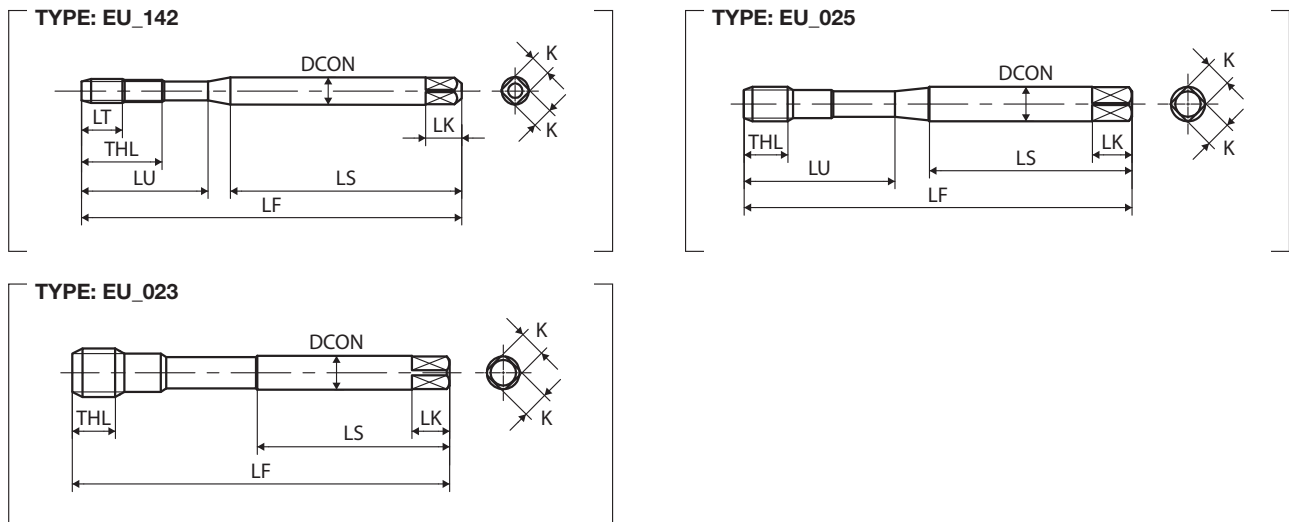

DIES

CENTER DRILLS

Technical info



M	TCTR (tolerance)	\varnothing (mm)	Hole \varnothing (mm)	Code	THCHT (chamfer)	LF (mm)	LT (mm)	THL (mm)	LU (mm)	LS (mm)	DCON (mm)	K (mm)	LK (mm)	NOF	Type	Stock
DIN 371																
M3X0.5	ISO2X(6HX)	2.5	2.56	SD3.0GBJPX	3P	56	5	9	18	34	3.5	2.7	6	3	142	●
M4X0.7	ISO2X(6HX)	3.3	3.38	SD4.0IBJPX	3P	63	7	13	21	38	4.5	3.4	6	3	142	●
M5X0.8	ISO2X(6HX)	4.2	4.28	SD5.0KBJPX	3P	70	9	14	25	39	6	4.9	8	3	142	●
M6X1	ISO2X(6HX)	5	5.09	SD6.0MBJPX	3P	80	11	15	30	45	6	4.9	8	3	142	●
M8X1.25	ISO2X(6HX)	6.8	6.85	SD8.0NBJPX	3P	90	-	12	35	47	8	6.2	9	3	025	●
M10X1.5	ISO2X(6HX)	8.5	8.6	SD0100BJPX	3P	100	-	13	39	52	10	8	11	3	025	●

M	TCTR (tolerance)	 Hole Ø (mm)	Hole Ø (mm)	Code	THCHT (chamfer)	LF (mm)	LT (mm)	THL (mm)	LU (mm)	LS (mm)	DCON (mm)	K (mm)	LK (mm)	NOF	Type	Stock
DIN 376																
M12X1.75	ISO2X(6HX)	10.3	10.36	SG012PBJPX	3P	110	-	15	-	56	9	7	10	3	023	●
M14X2	ISO2X(6HX)	12	12.12	SG014QBJPX	3P	110	-	18	-	56	11	9	12	3	023	●
M16X2	ISO2X(6HX)	14	14.12	SG016QBJPX	3P	110	-	18	-	56	12	9	12	3	023	●
M18X2.5	ISO2X(6HX)	15.5	15.63	SG018RBJPX	3P	125	-	20	-	64	14	11	14	4	023	●
M20X2.5	ISO2X(6HX)	17.5	17.63	SG020RBJPX	3P	140	-	20	-	71	16	12	15	4	023	●
M24X3	ISO2X(6HX)	21	21.13	SG024SBJPX	3P	160	-	25	-	82	18	14.5	17	4	023	●
MF	TCTR (tolerance)	 Hole Ø (mm)	Hole Ø (mm)	Code	THCHT (chamfer)	LF (mm)	LT (mm)	THL (mm)	LU (mm)	LS (mm)	DCON (mm)	K (mm)	LK (mm)	NOF	Type	Stock
DIN 374																
M10X1.25	ISO2X(6HX)	8.8	8.85	SM010NBJPX	3P	100	-	13	-	51	7	5.5	8	3	023	●
M12X1.5	ISO2X(6HX)	10.5	10.6	SM0120BJPX	3P	100	-	15	-	51	9	7	10	3	023	●
M12X1.25	ISO2X(6HX)	10.8	10.85	SM012NBJPX	3P	100	-	15	-	51	9	7	10	3	023	●
M14X1.5	ISO2X(6HX)	12.5	12.6	SM0140BJPX	3P	100	-	14	-	51	11	9	12	3	023	●
M16X1.5	ISO2X(6HX)	14.5	14.6	SM0160BJPX	3P	100	-	14	-	51	12	9	12	3	023	●
UNC	TCTR (tolerance)	 Hole Ø (mm)	Hole Ø (mm)	Code	THCHT (chamfer)	LF (mm)	LT (mm)	THL (mm)	LU (mm)	LS (mm)	DCON (mm)	K (mm)	LK (mm)	NOF	Type	Stock
DIN 371																
No.4-40UNC	2BX	2.3	2.33	SDUN4HYJPX	3P	56	5	9	18	34	3.5	2.7	6	3	142	●
No.6-32UNC	2BX	2.8	2.83	SDUN6JYJPX	3P	56	7	11	19	32	4	3	6	3	142	●
No.8-32UNC	2BX	3.4	3.47	SDUN8JYJPX	3P	63	7	13	21	38	4.5	3.4	6	3	142	●
No.10-24UNC	2BX	3.89	3.9	SDUNAMYJPX	3P	70	9	14	24	39	6	4.9	8	3	142	●
1/4-20UNC	2BX	5.1	5.19	SDU04NYJPX	3P	80	11	15	30	42	7	5.5	8	3	142	●
5/16-18UNC	2BX	6.6	6.65	SDU050YJPX	3P	90	-	12	35	47	8	6.2	9	3	025	●
3/8-16UNC	2BX	8	8.07	SDU06PYJPX	3P	100	-	13	39	54	9	7	10	3	025	●
UNC	TCTR (tolerance)	 Hole Ø (mm)	Hole Ø (mm)	Code	THCHT (chamfer)	LF (mm)	LT (mm)	THL (mm)	LU (mm)	LS (mm)	DCON (mm)	K (mm)	LK (mm)	NOF	Type	Stock
DIN 376																
1/2-13UNC	2BX	10.9	10.91	SGU08RYJPX	3P	110	-	15	-	56	9	7	10	3	023	●
5/8-11UNC	2BX	13.6	13.75	SGU10UYJPX	3P	110	-	18	-	56	12	9	12	3	023	●
3/4-10UNC	2BX	16.6	16.7	SGU12VYJPX	3P	125	-	20	-	64	14	11	14	4	023	●
UNF	TCTR (tolerance)	 Hole Ø (mm)	Hole Ø (mm)	Code	THCHT (chamfer)	LF (mm)	LT (mm)	THL (mm)	LU (mm)	LS (mm)	DCON (mm)	K (mm)	LK (mm)	NOF	Type	Stock
DIN 371																
No.10-32UNF	2BX	4.1	4.12	SDUNA JYJPX	3P	70	9	14	24	39	6	4.9	8	3	142	●
1/4-28UNF	2BX	5.5	5.53	SDU04KYJPX	3P	80	11	15	30	42	7	5.5	8	3	142	●
UNF	TCTR (tolerance)	 Hole Ø (mm)	Hole Ø (mm)	Code	THCHT (chamfer)	LF (mm)	LT (mm)	THL (mm)	LU (mm)	LS (mm)	DCON (mm)	K (mm)	LK (mm)	NOF	Type	Stock
DIN 374																
5/16-24UNF	2BX	6.9	6.97	SMU05MYJPX	3P	90	-	12	-	46	6	4.9	8	3	023	●
3/8-24UNF	2BX	8.5	8.57	SMU06MYJPX	3P	100	-	13	-	51	7	5.5	8	3	023	●
7/16-20UNF	2BX	9.9	9.96	SMU07NYJPX	3P	100	-	13	-	51	8	6.2	9	3	023	○
1/2-20UNF	2BX	11.5	11.54	SMU08NYJPX	3P	100	-	15	-	51	9	7	10	3	023	●
9/16-18UNF	2BX	12.9	13	SMU090YJPX	3P	100	-	14	-	51	11	9	12	3	023	●
5/8-18UNF	2BX	14.5	14.6	SMU100YJPX	3P	100	-	14	-	51	12	9	12	3	023	●
3/4-16UNF	2BX	17.5	17.59	SMU12PYJPX	3P	110	-	14	-	56	14	11	14	4	023	●

Intro

SP

DIN

SL

PO

ST

ROLL

CARBIDE

LONG

HAND TAPS

EG (STI)

SPECIAL THREADS, GAUGES

THREAD MILLS

DIES

CENTER DRILLS

Technical info

Intro

ZET-B

MS Material Specific Series

Low Spiral Fluted Taps for Titanium Base Alloys



SP

DIN

SL



PO

Recommended Tapping Speeds Depending On Materials

ISO	Vc (m/min)	ISO	Vc (m/min)	ISO	Vc (m/min)	ISO	Vc (m/min)
P4	5÷10 ☆	M3	3÷6 ☆	K2	5÷10 ☆	S1	5÷10 ☆
P5	5÷8 ☆			K3	5÷10 ☆	S2	5÷10 ☆
P6	3÷6 ☆					S3	3÷6 ★
P8	3÷6 ☆					S5	5÷10 ★

★ 1st choice ☆ suitable

ROLL

CARBIDE

LONG

HAND TAPS

EG (STI)

SPECIAL THREADS, GAUGES

THREAD MILLS

DIES

CENTER DRILLS

Technical info

FEATURES

Material specific for blind hole application.

Specific design and NI treatment allow high performance on Titanium base alloys.

Also suitable for high tensile strength steel, high alloy steel and cast iron.

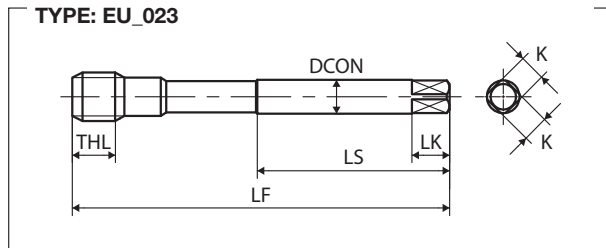
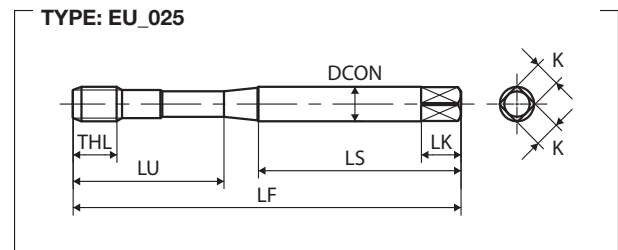
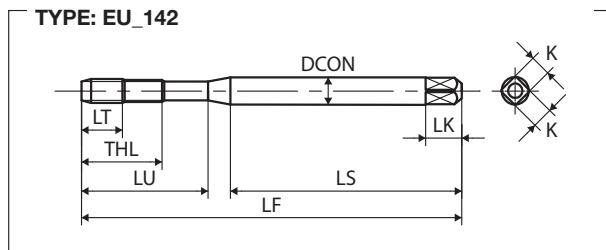



M	TCTR (tolerance)	∅ (mm)	Hole ∅ (mm)	Code	THCHT (chamfer)	LF (mm)	LT (mm)	THL (mm)	LU (mm)	LS (mm)	DCON (mm)	K (mm)	LK (mm)	NOF	Type	Stock
DIN 371																
M2X0.4 (JIS)	P2	1.6	1.65	ZETBMQ2.0E	3P	42	4	7.2	12	27	3	2.5	5	2	142	●
M2.5X0.45 (JIS)	P2	2.1	2.11	ZETBMQ2.5F	3P	46	4	8.1	14	29	3	2.5	5	2	142	●
M3X0.5	ISO2X(6HX)	2.5	2.56	SD3.0GBIPN	3P	56	5	7	18	34	3.5	2.7	6	3	142	●
M4X0.7	ISO2X(6HX)	3.3	3.38	SD4.0IBIPN	3P	63	7	13	21	38	4.5	3.4	6	3	142	●
M5X0.8	ISO2X(6HX)	4.2	4.28	SD5.0KBIPN	3P	70	9	14	25	39	6	4.9	8	3	142	●
M6X1	ISO2X(6HX)	5	5.09	SD6.0MBIPN	3P	80	11	15	30	45	6	4.9	8	3	142	●
M8X1.25	ISO2X(6HX)	6.8	6.85	SD8.0NBIPN	3P	90	-	12	35	47	8	6.2	9	3	025	●
M10X1.5	ISO2X(6HX)	8.5	8.6	SD0100BIPN	3P	100	-	13	39	52	10	8	11	3	025	●

M	TCTR (tolerance)	 Hole Ø (mm)	Hole Ø (mm)	Code	THCHT (chamfer)	LF (mm)	LT (mm)	THL (mm)	LU (mm)	LS (mm)	DCON (mm)	K (mm)	LK (mm)	NOF	Type	Stock
DIN 376																
M12X1.75	ISO2X(6HX)	10.3	10.36	SG012PBIPN	3P	110	-	15	-	56	9	7	10	3	023	●
M14X2	ISO2X(6HX)	12	12.12	SG014QBIPN	3P	110	-	18	-	56	11	9	12	3	023	●
M16X2	ISO2X(6HX)	14	14.12	SG016QBIPN	3P	110	-	18	-	56	12	9	12	4	023	●
M18X2.5	ISO2X(6HX)	15.5	15.63	SG018RBIPN	3P	125	-	20	-	64	14	11	14	4	023	○
M20X2.5	ISO2X(6HX)	17.5	17.63	SG020RBIPN	3P	140	-	20	-	71	16	12	15	4	023	●
M24X3	ISO2X(6HX)	21	21.13	SG024SBIPN	3P	160	-	25	-	82	18	14.5	17	4	023	●

MF	TCTR (tolerance)	 Hole Ø (mm)	Hole Ø (mm)	Code	THCHT (chamfer)	LF (mm)	LT (mm)	THL (mm)	LU (mm)	LS (mm)	DCON (mm)	K (mm)	LK (mm)	NOF	Type	Stock
DIN 374																
M10X1.25	ISO2X(6HX)	8.8	8.85	SM010NBIPN	3P	100	-	13	-	51	7	5.5	8	3	023	●
M12X1.5	ISO2X(6HX)	10.5	10.6	SM0120BIPN	3P	100	-	15	-	51	9	7	10	3	023	●
M12X1.25	ISO2X(6HX)	10.8	10.85	SM012NBIPN	3P	100	-	15	-	51	9	7	10	3	023	●
M14X1.5	ISO2X(6HX)	12.5	12.6	SM0140BIPN	3P	100	-	14	-	51	11	9	12	3	023	●
M16X1.5	ISO2X(6HX)	14.5	14.6	SM0160BIPN	3P	100	-	14	-	51	12	9	12	4	023	●

UNC	TCTR (tolerance)	 Hole Ø (mm)	Hole Ø (mm)	Code	THCHT (chamfer)	LF (mm)	LT (mm)	THL (mm)	LU (mm)	LS (mm)	DCON (mm)	K (mm)	LK (mm)	NOF	Type	Stock
DIN 371																
No.4-40UNC	2BX	2.3	2.33	SDUN4HYIPN	3P	56	5	9	18	34	3.5	2.7	6	3	142	●
No.6-32UNC	2BX	2.8	2.83	SDUN6JYIPN	3P	56	7	11	19	32	4	3	6	3	142	●
No.8-32UNC	2BX	3.4	3.47	SDUN8JYIPN	3P	63	7	13	21	38	4.5	3.4	6	3	142	●
No.10-24UNC	2BX	3.89	3.9	SDUNAMYIPN	3P	70	9	14	24	39	6	4.9	8	3	142	●
1/4-20UNC	2BX	5.1	5.19	SDU04NYIPN	3P	80	11	15	30	42	7	5.5	8	3	142	●
5/16-18UNC	2BX	6.6	6.65	SDU050YIPN	3P	90	-	12	35	47	8	6.2	9	3	025	●
3/8-16UNC	2BX	8	8.07	SDU06PYIPN	3P	100	-	13	39	54	9	7	10	3	025	●

UNC	TCTR (tolerance)	 Hole Ø (mm)	Hole Ø (mm)	Code	THCHT (chamfer)	LF (mm)	LT (mm)	THL (mm)	LU (mm)	LS (mm)	DCON (mm)	K (mm)	LK (mm)	NOF	Type	Stock
DIN 376																
1/2-13UNC	2BX	10.9	10.91	SGU08RYIPN	3P	110	-	15	-	56	9	7	10	3	023	●
5/8-11UNC	2BX	13.6	13.75	SGU10UYIPN	3P	110	-	18	-	56	12	9	12	4	023	●
3/4-10UNC	2BX	16.6	16.7	SGU12VYIPN	3P	125	-	20	-	64	14	11	14	4	023	●

UNF	TCTR (tolerance)	 Hole Ø (mm)	Hole Ø (mm)	Code	THCHT (chamfer)	LF (mm)	LT (mm)	THL (mm)	LU (mm)	LS (mm)	DCON (mm)	K (mm)	LK (mm)	NOF	Type	Stock
DIN 371																
No.6-40UNF	2BX	2.9	2.97	SDUN6HYIPN	3P	56	7	11	19	32	4	3	6	3	142	●
No.10-32UNF	2BX	4.1	4.12	SDUNA JYIPN	3P	70	9	14	24	39	6	4.9	8	3	142	●
1/4-28UNF	2BX	5.5	5.53	SDU04KYIPN	3P	80	11	15	30	42	7	5.5	8	3	142	●

UNF	TCTR (tolerance)	 Hole Ø (mm)	Hole Ø (mm)	Code	THCHT (chamfer)	LF (mm)	LT (mm)	THL (mm)	LU (mm)	LS (mm)	DCON (mm)	K (mm)	LK (mm)	NOF	Type	Stock
DIN 374																
5/16-24UNF	2BX	6.9	6.97	SMU05MYIPN	3P	90	-	12	-	46	6	4.9	8	3	023	●
3/8-24UNF	2BX	8.5	8.57	SMU06MYIPN	3P	100	-	13	-	51	7	5.5	8	3	023	●
1/2-20UNF	2BX	11.5	11.54	SMU08NYIPN	3P	100	-	15	-	51	9	7	10	3	023	●

Intro

SP

DIN

SL

PO

ST

ROLL

CARBIDE

LONG

HAND TAPS

EG (STI)

SPECIAL THREADS, GAUGES

THREAD MILLS

DIES

CENTER DRILLS

Technical info

Intro

F-SP

HS High Speed Series

Spiral Fluted Taps for High Speed Tapping, Coated



SP

DIN

SL

PO

ST

ROLL

CARBIDE

LONG

HAND TAPS

EG (STI)

SPECIAL THREADS, GAUGES

THREAD MILLS

DIES

CENTER DRILLS

Technical info



FEATURES

High Speed for blind hole application.

Most suitable for steel, can be used even on stainless steel and non-ferrous materials.

For Synchro-rigid tapping system.

Recommended Tapping Speeds Depending On Materials

ISO	Vc (m/min)	ISO	Vc (m/min)	ISO	Vc (m/min)
P1	15÷25 ★	M1	10÷20 ☆	N1	15÷30 ★
P2	15÷25 ★	M2	10÷20 ☆	N2	15÷30 ★
P3	15÷25 ☆				
P4	15÷25 ☆				
P7	10÷20 ☆				

★ 1st choice ☆ suitable

This item will be gradually replaced by:

· VUSP DIN page 80

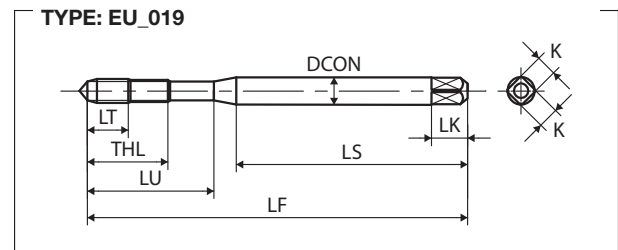
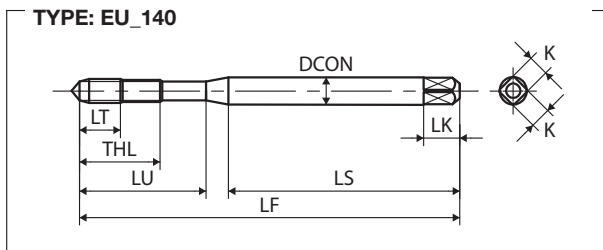

M	TCTR (tolerance)	Hole Ø (mm)	Hole Ø (mm)	Code	THCHT (chamfer)	LF (mm)	LT (mm)	THL (mm)	LU (mm)	LS (mm)	DCON (mm)	K (mm)	LK (mm)	NOF	Type	Stock
DIN 371																
M3X0.5	IS02X(6HX)	2.5	2.56	SD3.0GBNEV	2.5P	56	5	9	18	34	3.5	2.7	6	3	140	▽
M4X0.7	IS02X(6HX)	3.3	3.38	SD4.0IBNEV	2.5P	63	7	13	21	38	4.5	3.4	6	3	140	▽
M5X0.8	IS02X(6HX)	4.2	4.28	SD5.0KBNEV	2.5P	70	9	14	25	39	6	4.9	8	3	140	▽
M	TCTR (tolerance)	Hole Ø (mm)	Hole Ø (mm)	Code	THCHT (chamfer)	LF (mm)	LT (mm)	THL (mm)	LU (mm)	LS (mm)	DCON (mm)	K (mm)	LK (mm)	NOF	Type	Stock
DIN YMW																
M6X1	IS02X(6HX)	5	5.09	SY6.0MBNEV	2.5P	80	11	15	30	45	6	4.9	8	3	019	▽
M8X1.25	IS02X(6HX)	6.8	6.85	SY8.0NBNEV	2.5P	90	-	12	35	48	8	6.2	9	3	019	▽
M10X1.5	IS02X(6HX)	8.5	8.6	SY0100BNEV	2.5P	100	-	13	39	53	10	8	11	3	019	▽
M12X1.75	IS02X(6HX)	10.3	10.36	SY012PBNEV	2.5P	110	-	15	45	56	12	9	12	3	019	▽
MF	TCTR (tolerance)	Hole Ø (mm)	Hole Ø (mm)	Code	THCHT (chamfer)	LF (mm)	LT (mm)	THL (mm)	LU (mm)	LS (mm)	DCON (mm)	K (mm)	LK (mm)	NOF	Type	Stock
DIN YMW																
M10X1.25	IS02X(6HX)	8.8	8.85	SY010NBNEV	2.5P	100	-	13	39	53	10	8	11	3	019	▽
M12X1.5	IS02X(6HX)	10.5	10.6	SY0120BNEV	2.5P	110	-	15	45	56	12	9	12	3	019	▽
M12X1.25	IS02X(6HX)	10.8	10.85	SY012NBNEV	2.5P	110	-	15	45	56	12	9	12	3	019	▽

HFIHS

HS High Speed Series

Spiral Fluted Taps with Axial Coolant Hole for Ultra Fast Tapping, Coated



FEATURES

Ultra High Speed with axial coolant hole for blind hole application

Most suitable for steel and alloy steel.

For Synchro-rigid tapping system. High helix for vertical tapping direction.

Recommended Tapping Speeds Depending On Materials

ISO	Vc (m/min)	ISO	Vc (m/min)	ISO	Vc (m/min)
P1	20÷50 ★	M1	15÷30 ☆	K1	20÷40 ☆
P2	20÷50 ★	M2	15÷25 ☆	K2	20÷40 ☆
P3	20÷30 ★				
P4	20÷30 ★				
P5	15÷25 ☆				
P7	15÷30 ☆				

★ 1st choice ☆ suitable

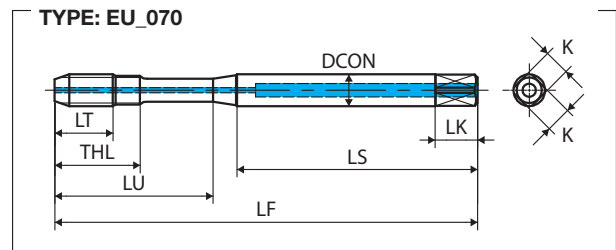
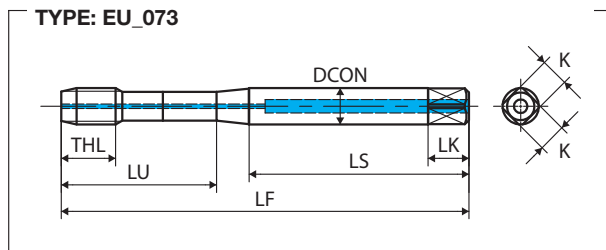

M	TCTR (tolerance)	Hole Ø (mm)	Hole Ø (mm)	Code	THCHT (chamfer)	LF (mm)	LT (mm)	THL (mm)	LU (mm)	LS (mm)	DCON (mm)	K (mm)	LK (mm)	NOF	Type	Stock
DIN YMW																
M6X1	ISO2X(6HX)	5	5.09	SY6.0MBEDTZ	2.5P	80	11	15	30	45	6	4.9	8	3	070	●
M8X1.25	ISO2X(6HX)	6.8	6.85	SY8.0NBEDTZ	2.5P	90	-	12	35	48	8	6.2	9	3	073	●
M10X1.5	ISO2X(6HX)	8.5	8.6	SY0100BEDTZ	2.5P	100	-	13	39	53	10	8	11	3	073	●
M12X1.75	ISO2X(6HX)	10.3	10.36	SY012PBEDTZ	2.5P	110	-	15	44	57	12	9	12	3	073	●
M14X2	ISO2X(6HX)	12	12.12	OHFBZ010	2.5P	110	-	18	-	62	12	9	12	3	073	●
M16X2	ISO2X(6HX)	14	14.12	OHFBZ011	2.5P	110	-	18	-	58	16	12	15	3	073	●
MF	TCTR (tolerance)	Hole Ø (mm)	Hole Ø (mm)	Code	THCHT (chamfer)	LF (mm)	LT (mm)	THL (mm)	LU (mm)	LS (mm)	DCON (mm)	K (mm)	LK (mm)	NOF	Type	Stock
DIN YMW																
M10X1.25	ISO2X(6HX)	8.8	8.85	SY010NBEDTZ	2.5P	100	-	13	39	53	10	8	11	3	073	●
M12X1.5	ISO2X(6HX)	10.5	10.6	SY0120BEDTZ	2.5P	110	-	15	44	57	12	9	12	3	073	●
M12X1.25	ISO2X(6HX)	10.8	10.85	SY012NBEDTZ	2.5P	110	-	15	44	57	12	9	12	3	073	●
M14X1.5	ISO2X(6HX)	12.5	12.6	OHFBZ008	2.5P	110	-	14	-	62	12	9	12	3	073	●
M16X1.5	ISO2X(6HX)	14.5	14.6	OHFBZ009	2.5P	110	-	14	-	58	16	12	15	3	073	●

- Intro
- SP
- DIN
- SL
- PO
- ST
- ROLL
- CARBIDE
- LONG
- HAND TAPS
- EG (STI)
- SPECIAL THREADS, GAUGES
- THREAD MILLS
- DIES
- CENTER DRILLS
- Technical info

Intro

HFISP



HS High Speed Series

SP Low Spiral Fluted Taps with Axial Coolant Hole for Ultra Fast Tapping, Coated

DIN

SL



FEATURES

Ultra High Speed with axial coolant hole for blind hole application

Most suitable for steel, alloy steel and cast iron.

For Synchro-rigid tapping system. Low helix for horizontal tapping direction.

Recommended Tapping Speeds Depending On Materials

ISO	Vc (m/min)	ISO	Vc (m/min)	ISO	Vc (m/min)
P1	20÷50 ★	M1	15÷30 ☆	K1	20÷40 ★
P2	20÷50 ★	M2	15÷25 ☆	K2	20÷40 ★
P3	20÷30 ★				
P4	20÷30 ★				
P5	15÷25 ☆				
P7	15÷30 ☆				

★ 1st choice ☆ suitable

ST

ROLL

CARBIDE

LONG

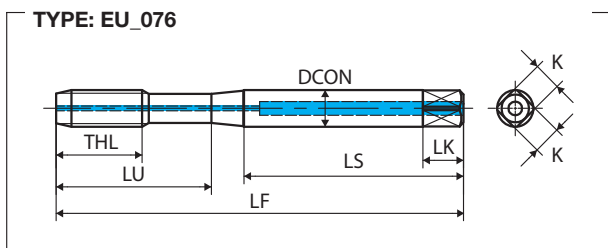

HAND TAPS

M	TCTR (tolerance)	∅ (mm)	Hole ∅ (mm)	Code	THCHT (chamfer)	LF (mm)	LT (mm)	THL (mm)	LU (mm)	LS (mm)	DCON (mm)	K (mm)	LK (mm)	NOF	Type	Stock
DIN YMW																
M6X1	ISO2X(6HX)	5	5.09	SY6.0NBEDTHZ	2.5P	80	-	15	30	45	6	4.9	8	3	076	●
M8X1.25	ISO2X(6HX)	6.8	6.85	SY8.0NBEDTHZ	2.5P	90	-	19	35	48	8	6.2	9	3	076	●
M10X1.5	ISO2X(6HX)	8.5	8.6	SY0100BEDTHZ	2.5P	100	-	23	39	53	10	8	11	3	076	●
M12X1.75	ISO2X(6HX)	10.3	10.36	SY012PBEDTHZ	2.5P	110	-	26	44	57	12	9	12	3	076	●
M14X2	ISO2X(6HX)	12	12.12	OHFBZ006	2.5P	110	-	26	-	62	12	9	12	3	076	●
M16X2	ISO2X(6HX)	14	14.12	OFFBZ004	2.5P	110	-	26	-	58	16	12	15	3	076	●

EG (STI)

SPECIAL THREADS, GAUGES

THREAD MILLS

MF	TCTR (tolerance)	∅ (mm)	Hole ∅ (mm)	Code	THCHT (chamfer)	LF (mm)	LT (mm)	THL (mm)	LU (mm)	LS (mm)	DCON (mm)	K (mm)	LK (mm)	NOF	Type	Stock
DIN YMW																
M10X1.25	ISO2X(6HX)	8.8	8.85	SY010NBEDTHZ	2.5P	100	-	23	39	53	10	8	11	3	076	●
M12X1.5	ISO2X(6HX)	10.5	10.6	SY0120BEDTHZ	2.5P	110	-	26	44	57	12	9	12	3	076	●
M12X1.25	ISO2X(6HX)	10.8	10.85	SY012NBEDTHZ	2.5P	110	-	26	44	57	12	9	12	3	076	●
M14X1.5	ISO2X(6HX)	12.5	12.6	OHFBZ005	2.5P	110	-	26	-	62	12	9	12	3	076	●
M16X1.5	ISO2X(6HX)	14.5	14.6	OHFBZ007	2.5P	110	-	26	-	58	16	12	15	3	076	●
M18X1.5	ISO2X(6HX)	16.5	16.6	PAFBZ010	2.5P	125	-	-	-	-	16	12	15		076	●

DIES

CENTER DRILLS

Technical info

HFAHS

HS High Speed Series

Spiral Fluted Taps with Axial Coolant Hole for Ultra Fast Tapping, Coated



FEATURES

Ultra High Speed with axial coolant hole for blind hole application

Most suitable for Aluminium casting.

For Synchro-rigid tapping system. High helix for vertical tapping direction.

Recommended Tapping Speeds Depending On Materials

ISO Vc (m/min)

N1 30÷100 ★

N2 30÷100 ★

N4 30÷60 ☆

★ 1st choice ☆ suitable

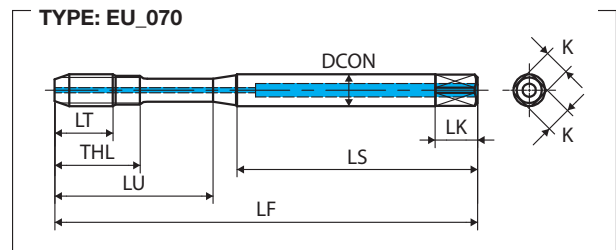
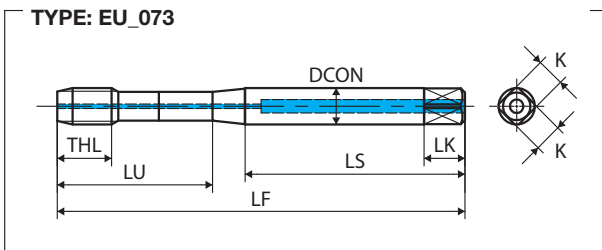

M	TCTR (tolerance)	Hole Ø (mm)	Hole Ø (mm)	Code	THCHT (chamfer)	LF (mm)	LT (mm)	THL (mm)	LU (mm)	LS (mm)	DCON (mm)	K (mm)	LK (mm)	NOF	Type	Stock
DIN YMW																
M6X1	ISO2X(6HX)	5	5.09	SY6.0MBLDTZ	2.5P	80	11	15	30	45	6	4.9	8	3	070	●
M8X1.25	ISO2X(6HX)	6.8	6.85	SY8.0NBLDTZ	2.5P	90	-	12	35	48	8	6.2	9	3	073	●
M10X1.5	ISO2X(6HX)	8.5	8.6	SY0100BLDTZ	2.5P	100	-	13	39	53	10	8	11	3	073	●
M12X1.75	ISO2X(6HX)	10.3	10.36	SY012PBLDTZ	2.5P	110	-	15	44	57	12	9	12	3	073	●
MF	TCTR (tolerance)	Hole Ø (mm)	Hole Ø (mm)	Code	THCHT (chamfer)	LF (mm)	LT (mm)	THL (mm)	LU (mm)	LS (mm)	DCON (mm)	K (mm)	LK (mm)	NOF	Type	Stock
DIN YMW																
M10X1.25	ISO2X(6HX)	8.8	8.85	SY010NBLDTZ	2.5P	100	-	13	39	53	10	8	11	3	073	○
M12X1.5	ISO2X(6HX)	10.5	10.6	SY0120BLDTZ	2.5P	110	-	15	44	57	12	9	12	3	073	○
M12X1.25	ISO2X(6HX)	10.8	10.85	SY012NBLDTZ	2.5P	110	-	15	44	57	12	9	12	3	073	○

Intro

SP

DIN

SL

PO

ST

ROLL

CARBIDE

LONG

HAND TAPS

EG (STI)

SPECIAL THREADS, GAUGES

THREAD MILLS

DIES

CENTER DRILLS

Technical info

Intro

HFASP



HS High Speed Series

SP
DIN Low Spiral Fluted Taps with Axial Coolant Hole for Ultra Fast Tapping, Coated

SL



PO

Recommended Tapping Speeds Depending On Materials

ISO Vc (m/min)

N1 30÷100 ★

N2 30÷100 ★

N4 30÷60 ☆

ST

★ 1st choice ☆ suitable

ROLL

CARBIDE

LONG

HAND TAPS

EG (STI)

SPECIAL THREADS, GAUGES

THREAD MILLS

DIES

CENTER DRILLS

Technical info

FEATURES



Ultra High Speed with axial coolant hole for blind hole application

Most suitable for Aluminium casting.

For Synchro-rigid tapping system. Low helix for horizontal tapping direction.

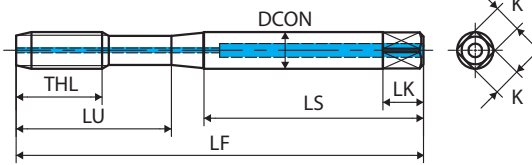
TYPE: EU_076



M	TCTR (tolerance)	 Hole Ø (mm)	Hole Ø (mm)	Code	THCHT (chamfer)	LF (mm)	LT (mm)	THL (mm)	LU (mm)	LS (mm)	DCON (mm)	K (mm)	LK (mm)	NOF	Type	Stock
DIN YMW																
M6X1	IS02X(6HX)	5	5.09	SY6.0MBLDTHZ	2.5P	80	-	15	30	45	6	4.9	8	3	076	●
M8X1.25	IS02X(6HX)	6.8	6.85	SY8.0NBLDTHZ	2.5P	90	-	19	35	48	8	6.2	9	3	076	●
M10X1.5	IS02X(6HX)	8.5	8.6	SY0100BLDTHZ	2.5P	100	-	23	39	53	10	8	11	3	076	●
M12X1.75	IS02X(6HX)	10.3	10.36	SY012PBLDTHZ	2.5P	110	-	26	44	57	12	9	12	3	076	●
MF	TCTR (tolerance)	 Hole Ø (mm)	Hole Ø (mm)	Code	THCHT (chamfer)	LF (mm)	LT (mm)	THL (mm)	LU (mm)	LS (mm)	DCON (mm)	K (mm)	LK (mm)	NOF	Type	Stock
DIN YMW																
M10X1.25	IS02X(6HX)	8.8	8.85	SY010NBLDTHZ	2.5P	100	-	23	39	53	10	8	11	3	076	○
M12X1.5	IS02X(6HX)	10.5	10.6	SY0120BLDTHZ	2.5P	110	-	26	44	57	12	9	12	3	076	○
M12X1.25	IS02X(6HX)	10.8	10.85	SY012NBLDTHZ	2.5P	110	-	26	44	57	12	9	12	3	076	○

Intro

SP

DIN

SL

PO

ST

ROLL

CARBIDE

LONG

HAND
TAPS

EG (STI)

SPECIAL
THREADS,
GAUGESTHREAD
MILLS

DIES

CENTER
DRILLSTechnical
info

Intro

SP

GP General Purpose Series

Spiral Fluted Taps



SP

JIS

SL



FEATURES

General purpose for blind hole application.

For tapping steel at medium-low cutting speed, also suitable for non-ferrous materials.

PO

Recommended Tapping Speeds Depending On Materials

ISO	Vc (m/min)	ISO	Vc (m/min)
P1	5÷10 ☆	N1	5÷10 ☆
P2	5÷10 ★	N2	5÷10 ☆
P3	5÷10 ☆	N3	5÷10 ☆
P4	5÷8 ☆	N4	5÷10 ☆

★ 1st choice ☆ suitable

ROLL

CARBIDE

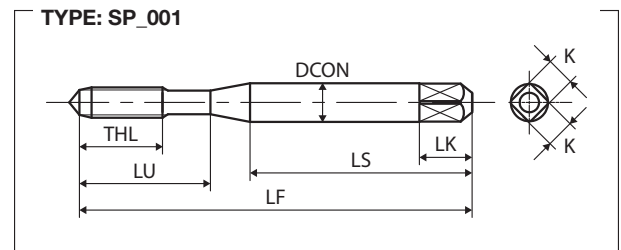
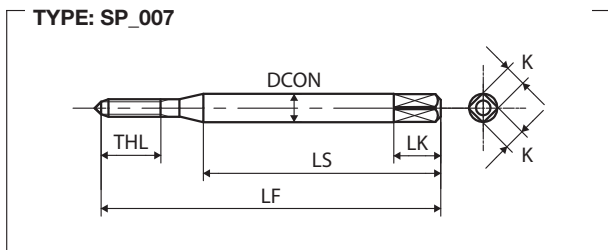

LONG

HAND TAPS

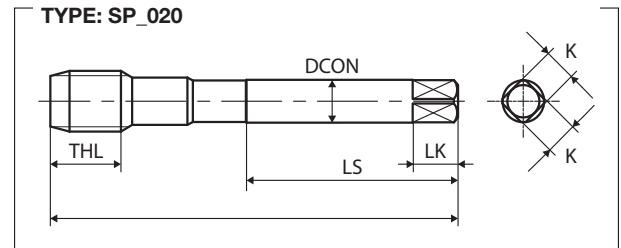
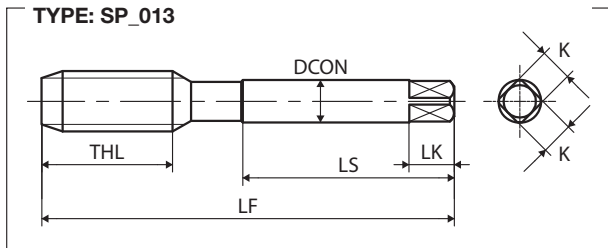

EG (STI)

SPECIAL THREADS, GAUGES

M	TCTR (tolerance)	\varnothing (mm)	Hole \varnothing (mm)	Code	THCHT (chamfer)	LF (mm)	LT (mm)	THL (mm)	LU (mm)	LS (mm)	DCON (mm)	K (mm)	LK (mm)	NOF	Type	Stock
JIS																
M1.2X0.25	P1	0.95	0.97	SPP1.2B	2.5P	36	-	4.5	-	24	3	2.5	5	2	007	●
M1.4X0.3	P1	1.1	1.13	SPP1.4C	2.5P	36	-	5.4	-	24	3	2.5	5	2	007	●
M1.6X0.35	P1	1.25	1.3	SPP1.6D	2.5P	36	-	6.3	-	24	3	2.5	5	2	007	●
M1.7X0.35	P1	1.35	1.4	SPP1.7D	2.5P	36	-	6.3	-	24	3	2.5	5	2	007	●
	P2(P1+15)	1.35	1.4	SPQ1.7D	2.5P	36	-	6.3	-	24	3	2.5	5	2	007	○
	P3(P1+30)	1.35	1.4	SPR1.7D	2.5P	36	-	6.3	-	24	3	2.5	5	2	007	○
M1.8X0.35	P1	1.45	1.5	SPP1.8D	2.5P	42	-	6.3	-	27	3	2.5	5	2	007	●
M2X0.4	P1	1.6	1.65	SPP2.0E	2.5P	42	-	7.2	12	27	3	2.5	5	2	001	○
	P2(P1+15)	1.6	1.65	SPQ2.0E	2.5P	42	-	7.2	12	27	3	2.5	5	2	001	○
	P3(P1+30)	1.6	1.65	SPR2.0E	2.5P	42	-	7.2	12	27	3	2.5	5	2	001	○
	P4(P1+45)	1.6	1.65	SPS2.0E	2.5P	42	-	7.2	12	27	3	2.5	5	2	001	○

Technical info

M	TCTR (tolerance)	∅ (mm)	Hole ∅ (mm)	Code	THCHT (chamfer)	LF (mm)	LT (mm)	THL (mm)	LU (mm)	LS (mm)	DCON (mm)	K (mm)	LK (mm)	NOF	Type	Stock
JIS																
M2.2X0.45	P1	1.75	1.81	SPP2.2F	2.5P	42	-	8.1	12	27	3	2.5	5	2	001	●
	P3(P1+30)	1.75	1.81	SPR2.2F	2.5P	42	-	8.1	12	27	3	2.5	5	2	001	○
M2.3X0.4	P1	1.9	1.95	SPP2.3E	2.5P	42	-	7.2	12	27	3	2.5	5	2	001	●
	P2(P1+15)	1.9	1.95	SPQ2.3E	2.5P	42	-	7.2	12	27	3	2.5	5	2	001	○
	P3(P1+30)	1.9	1.95	SPR2.3E	2.5P	42	-	7.2	12	27	3	2.5	5	2	001	○
	P4(P1+45)	1.9	1.95	SPS2.3E	2.5P	42	-	7.2	12	27	3	2.5	5	2	001	○
M2.5X0.45	P1	2.1	2.11	SPP2.5F	2.5P	46	-	8.1	14	29	3	2.5	5	2	001	○
	P2(P1+15)	2.1	2.11	SPQ2.5F	2.5P	46	-	8.1	14	29	3	2.5	5	2	001	○
	P3(P1+30)	2.1	2.11	SPR2.5F	2.5P	46	-	8.1	14	29	3	2.5	5	2	001	○
	P4(P1+45)	2.1	2.11	SPS2.5F	2.5P	46	-	8.1	14	29	3	2.5	5	2	001	○
M2.6X0.45	P1	2.2	2.21	SPP2.6F	2.5P	46	-	8.1	14	29	3	2.5	5	2	001	○
	P2(P1+15)	2.2	2.21	SPQ2.6F	2.5P	46	-	8.1	14	29	3	2.5	5	2	001	○
	P3(P1+30)	2.2	2.21	SPR2.6F	2.5P	46	-	8.1	14	29	3	2.5	5	2	001	○
	P4(P1+45)	2.2	2.21	SPS2.6F	2.5P	46	-	8.1	14	29	3	2.5	5	2	001	○
3M0.6	P1	2.45	2.47	SPP3.0H	2.5P	46	-	9	14	26	4	3.2	6	3	001	○
M3X0.5	P1	2.5	2.56	SPP3.0G	2.5P	46	-	9	14	26	4	3.2	6	3	001	○
	P2(P1+15)	2.5	2.56	SPQ3.0G	2.5P	46	-	9	14	26	4	3.2	6	3	001	○
	P3(P1+30)	2.5	2.56	SPR3.0G	2.5P	46	-	9	14	26	4	3.2	6	3	001	○
	P4(P1+45)	2.5	2.56	SPS3.0G	2.5P	46	-	9	14	26	4	3.2	6	3	001	○
M3.5X0.6	P1	2.9	2.97	SPP3.5H	2.5P	52	-	11	16	29	5	4	7	3	001	○
	P2(P1+15)	2.9	2.97	SPQ3.5H	2.5P	52	-	11	16	29	5	4	7	3	001	○
	P3(P1+30)	2.9	2.97	SPR3.5H	2.5P	52	-	11	16	29	5	4	7	3	001	○
	P4(P1+45)	2.9	2.97	SPS3.5H	2.5P	52	-	11	16	29	5	4	7	3	001	○
4M0.75	P2	3.3	3.33	SPQ4.0J	2.5P	52	-	11	17	29	5	4	7	3	001	○
M4X0.7	P2	3.3	3.38	SPQ4.0I	2.5P	52	-	11	17	29	5	4	7	3	001	○
	P3(P2+20)	3.3	3.38	SPR4.0I	2.5P	52	-	11	17	29	5	4	7	3	001	○
	P4(P2+40)	3.3	3.38	SPS4.0I	2.5P	52	-	11	17	29	5	4	7	3	001	○
M4.5X0.75	P2	3.8	3.83	SPQ4.5J	2.5P	60	-	13	21	33	5.5	4.5	7	3	001	●
5M0.9	P2	4.15	4.19	SPQ5.0L	2.5P	60	-	13	22	33	5.5	4.5	7	3	001	○
M5X0.8	P2	4.2	4.28	SPQ5.0K	2.5P	60	-	13	22	33	5.5	4.5	7	3	001	○
	P3(P2+20)	4.2	4.28	SPR5.0K	2.5P	60	-	13	22	33	5.5	4.5	7	3	001	○
	P4(P2+40)	4.2	4.28	SPS5.0K	2.5P	60	-	13	22	33	5.5	4.5	7	3	001	○
M5.5X0.9	P2	4.65	4.69	SPQ5.5L	2.5P	62	-	15	26	33	6	4.5	7	3	001	●
M6X1	P2	5	5.09	SPQ6.0M	2.5P	62	-	15	26	33	6	4.5	7	3	001	○
	P2	5	5.09	SPQ6.0M-T	2.5P	62	-	15	26	33	6	4.5	7	3	001	○
	P3(P2+20)	5	5.09	SPR6.0M	2.5P	62	-	15	26	33	6	4.5	7	3	001	○
	P4(P2+40)	5	5.09	SPS6.0M	2.5P	62	-	15	26	33	6	4.5	7	3	001	○
M7X1	P2	6	6.09	SPQ7.0M	2.5P	70	-	19	-	36	6.2	5	8	3	013	○
	P3(P2+20)	6	6.09	SPR7.0M	2.5P	70	-	19	-	36	6.2	5	8	3	013	○
	P4(P2+40)	6	6.09	SPS7.0M	2.5P	70	-	19	-	36	6.2	5	8	3	013	○
M8X1.25	P2	6.8	6.85	SPQ8.0N	2.5P	70	-	19	-	36	6.2	5	8	3	013	○
	P3(P2+20)	6.8	6.85	SPR8.0N	2.5P	70	-	19	-	36	6.2	5	8	3	013	○
	P4(P2+40)	6.8	6.85	SPS8.0N	2.5P	70	-	19	-	36	6.2	5	8	3	013	○
M9X1.25	P2	7.8	7.85	SPQ9.0N	2.5P	75	-	23	-	38	7	5.5	8	3	013	○
M10X1.5	P2	8.5	8.6	SPQ0100	2.5P	75	-	23	-	38	7	5.5	8	3	013	○
	P3(P2+20)	8.5	8.6	SPR0100	2.5P	75	-	23	-	38	7	5.5	8	3	013	○
	P4(P2+40)	8.5	8.6	SPS0100	2.5P	75	-	23	-	38	7	5.5	8	3	013	○
M11X1.5	P2	9.5	9.6	SPQ0110	2.5P	82	-	26	-	42	8.5	6.5	9	3	013	○

Intro

SP

JIS

SL

PO

ST

ROLL

CARBIDE

LONG

HAND
TAPS

EG (STI)

SPECIAL
THREADS,
GAUGESTHREAD
MILLS

DIES

CENTER
DRILLSTechnical
info

Spiral Fluted Taps

Intro

	M	TCTR (tolerance)	\varnothing (mm)	Hole \varnothing (mm)	Code	THCHT (chamfer)	LF (mm)	LT (mm)	THL (mm)	LU (mm)	LS (mm)	DCON (mm)	K (mm)	LK (mm)	NOF	Type	Stock
	JIS																
SP JIS	M12X1.75	P2	10.3	10.36	SPQ012P	2.5P	82	-	26	-	42	8.5	6.5	9	3	013	○
		P3(P2+20)	10.3	10.36	SPR012P	2.5P	82	-	26	-	42	8.5	6.5	9	3	013	○
		P4(P2+40)	10.3	10.36	SPS012P	2.5P	82	-	26	-	42	8.5	6.5	9	3	013	○
SL	M14X2	P2	12	12.12	SPQ014Q	2.5P	88	-	26	-	45	10.5	8	11	3	013	○
		P3(P2+20)	12	12.12	SPR014Q	2.5P	88	-	26	-	45	10.5	8	11	3	013	○
		P4(P2+40)	12	12.12	SPS014Q	2.5P	88	-	26	-	45	10.5	8	11	3	013	○
PO	M16X2	P2	14	14.12	SPQ016Q	2.5P	95	-	26	-	48	12.5	10	13	3	013	○
		P3(P2+20)	14	14.12	SPR016Q	2.5P	95	-	26	-	48	12.5	10	13	3	013	○
		P4(P2+40)	14	14.12	SPS016Q	2.5P	95	-	26	-	48	12.5	10	13	3	013	○
		P5(P2+60)	14	14.12	SPT016Q	2.5P	95	-	26	-	48	12.5	10	13	3	013	○
ST	M18X2.5	P3	15.5	15.63	SPR018R	2.5P	100	-	33	-	51	14	11	14	4	013	○
		P4(P3+20)	15.5	15.63	SPS018R	2.5P	100	-	33	-	51	14	11	14	4	013	○
		M20X2.5	P3	17.5	17.63	SPR020R	2.5P	105	-	33	-	50	15	12	15	4	013
P4(P3+20)	17.5		17.63	SPS020R	2.5P	105	-	33	-	50	15	12	15	4	013	○	
ROLL	M22X2.5	P3	19.5	19.63	SPR022R	2.5P	115	-	33	-	55	17	13	16	4	013	○
		P4(P3+20)	19.5	19.63	SPS022R	2.5P	115	-	33	-	55	17	13	16	4	013	○
	M24X3	P3	21	21.13	SPR024S	2.5P	120	-	39	-	55	19	15	18	4	013	○
P4(P3+20)		21	21.13	SPS024S	2.5P	120	-	39	-	55	19	15	18	4	013	○	
CARBIDE	M27X3	P3	24	24.13	SPR027S	2.5P	130	-	39	-	60	20	15	18	4	013	○
	M30X3.5	P4	26.5	26.63	SPS030T	2.5P	135	-	46	-	62	23	17	20	4	013	○
	M33X3.5	P4	29.5	29.63	SPMS033T	2.5P	145	-	46	-	67	25	19	22	4	013	○
LONG	M36X4	P4	32	32.12	SPMS036U	2.5P	155	-	52	-	71	28	21	24	4	013	○
	M39X4	P4	35	35.12	SPMS039U	2.5P	165	-	52	-	76	30	23	26	4	013	○
	M42X4.5	P4	37.5	37.63	SPMS042V	2.5P	175	-	59	-	81	32	26	30	4	013	○
	M45X4.5	P4	40.5	40.63	SPMS045V	2.5P	180	-	59	-	83	35	26	30	4	013	○
	M48X5	P4	43	43.12	SPMS048W	2.5P	185	-	65	-	85	38	29	32	4	013	○
HAND TAPS	M52X5	P4	47	47.1	SPS052W	2.5P	195	-	70	-	86	42	35	35	4	013	○
	M56X5.5	P4	50.5	50.6	SPS056X	2.5P	205	-	70	-	91	44	38	38	4	013	○
	M60X5.5	P4	54.5	54.6	SPS060X	2.5P	215	-	76	-	96	46	38	38	4	013	○
M64X6	P4	58	58.1	SPS064Y	2.5P	225	-	79	-	100	48	42	42	4	013	○	
EG (STI)	JIS																
	MF	TCTR (tolerance)	\varnothing (mm)	Hole \varnothing (mm)	Code	THCHT (chamfer)	LF (mm)	LT (mm)	THL (mm)	LU (mm)	LS (mm)	DCON (mm)	K (mm)	LK (mm)	NOF	Type	Stock
SPECIAL THREADS, GAUGES	M2X0.25	P1	1.75	1.77	SPP2.0B	2.5P	42	-	4.5	12	27	3	2.5	5	2	001	●
	M2.3X0.25	P1	2.05	2.07	SPP2.3B	2.5P	42	-	4.5	12	27	3	2.5	5	2	001	○
	M2.5X0.35	P1	2.2	2.2	SPP2.5D	2.5P	46	-	6.3	14	29	3	2.5	5	2	001	●
THREAD MILLS	M2.6X0.35	P1	2.3	2.3	SPP2.6D	2.5P	46	-	6.3	14	29	3	2.5	5	2	001	○
	M3X0.35	P1	2.7	2.7	SPP3.0D	2.5P	46	-	6.5	14	26	4	3.2	6	3	001	●
	M3.5X0.35	P1	3.2	3.2	SPP3.5D	2.5P	52	-	6.5	16	29	5	4	7	3	001	○
DIES	M4X0.5	P1	3.5	3.56	SPP4.0G	2.5P	52	-	9	17	29	5	4	7	3	001	●
	M4.5X0.5	P1	4	4.06	SPP4.5G	2.5P	60	-	9	21	33	5.5	4.5	7	3	001	○
	M5X0.75	P2	4.3	4.33	SPQ5.0J	2.5P	60	-	13	22	33	5.5	4.5	7	3	001	○
	M5X0.5	P1	4.5	4.56	SPP5.0G	2.5P	60	-	9	22	33	5.5	4.5	7	3	001	●
	M5.5X0.5	P1	5	5.06	SPP5.5G	2.5P	62	-	9	26	33	6	4.5	7	3	001	○
CENTER DRILLS	M6X0.75	P2	5.3	5.33	SPQ6.0J	2.5P	62	-	15	26	33	6	4.5	7	3	001	●
		P3(P2+20)	5.3	5.33	SPR6.0J	2.5P	62	-	15	26	33	6	4.5	7	3	001	○
Technical info	M6X0.5	P1	5.5	5.56	SPP6.0G	2.5P	62	-	9	26	33	6	4.5	7	3	001	●
		P2(P1+15)	5.5	5.56	SPQ6.0G	2.5P	62	-	9	26	33	6	4.5	7	3	001	○
		P3(P1+30)	5.5	5.56	SPR6.0G	2.5P	62	-	9	26	33	6	4.5	7	3	001	○

MF	TCTR (tolerance)	∅ (mm)	Hole ∅ (mm)	Code	THCHT (chamfer)	LF (mm)	LT (mm)	THL (mm)	LU (mm)	LS (mm)	DCON (mm)	K (mm)	LK (mm)	NOF	Type	Stock
JIS																
M7X0.75	P2	6.3	6.33	SPQ7.0J	2.5P	70	-	19	-	36	6.2	5	8	3	013	●
M7X0.5	P2	6.5	6.56	SPQ7.0G	2.5P	70	-	10	-	36	6.2	5	8	3	020	●
M8X1	P2	7	7.09	SPQ8.0M	2.5P	70	-	19	-	36	6.2	5	8	3	013	○
	P3(P2+20)	7	7.09	SPR8.0M	2.5P	70	-	19	-	36	6.2	5	8	3	013	○
M8X0.75	P4(P2+40)	7	7.09	SPS8.0M	2.5P	70	-	19	-	36	6.2	5	8	3	013	○
	P2	7.3	7.33	SPQ8.0J	2.5P	70	-	19	-	36	6.2	5	8	3	013	○
M8X0.5	P3(P2+20)	7.3	7.33	SPR8.0J	2.5P	70	-	19	-	36	6.2	5	8	3	013	○
	P2	7.5	7.56	SPQ8.0G	2.5P	70	-	10	-	36	6.2	5	8	3	020	●
M9X1	P2	8	8.09	SPQ9.0M	2.5P	75	-	23	-	38	7	5.5	8	3	013	●
M9X0.75	P2	8.3	8.33	SPQ9.0J	2.5P	75	-	13	-	38	7	5.5	8	3	020	●
M9X0.5	P2	8.5	8.56	SPQ9.0G	2.5P	75	-	11	-	38	7	5.5	8	3	020	○
M10X1.25	P2	8.8	8.85	SPQ010N	2.5P	75	-	23	-	38	7	5.5	8	3	013	○
	P3(P2+20)	8.8	8.85	SPR010N	2.5P	75	-	23	-	38	7	5.5	8	3	013	○
	P4(P2+40)	8.8	8.85	SPS010N	2.5P	75	-	23	-	38	7	5.5	8	3	013	○
M10X1	P2	9	9.09	SPQ010M	2.5P	75	-	23	-	38	7	5.5	8	3	013	○
	P3(P2+20)	9	9.09	SPR010M	2.5P	75	-	23	-	38	7	5.5	8	3	013	○
	P4(P2+40)	9	9.09	SPS010M	2.5P	75	-	23	-	38	7	5.5	8	3	013	○
M10X0.75	P2	9.3	9.33	SPQ010J	2.5P	75	-	13	-	38	7	5.5	8	3	020	○
M10X0.5	P2	9.5	9.56	SPQ010G	2.5P	75	-	11	-	38	7	5.5	8	3	020	●
M11X1.25	P2	9.8	9.85	SPQ011N	2.5P	82	-	26	-	42	8.5	6.5	9	3	013	○
M11X1	P2	10	10.1	SPQ011M	2.5P	82	-	26	-	42	8.5	6.5	9	3	013	●
M11X0.75	P2	10.3	10.33	SPQ011J	2.5P	82	-	14	-	42	8.5	6.5	9	3	020	○
M12X1.5	P2	10.5	10.6	SPQ012O	2.5P	82	-	26	-	42	8.5	6.5	9	3	013	○
	P3(P2+20)	10.5	10.6	SPR012O	2.5P	82	-	26	-	42	8.5	6.5	9	3	013	○
	P4(P2+40)	10.5	10.6	SPS012O	2.5P	82	-	26	-	42	8.5	6.5	9	3	013	○
M12X1.25	P2	10.8	10.85	SPQ012N	2.5P	82	-	26	-	42	8.5	6.5	9	3	013	○
	P3(P2+20)	10.8	10.85	SPR012N	2.5P	82	-	26	-	42	8.5	6.5	9	3	013	○
	P4(P2+40)	10.8	10.85	SPS012N	2.5P	82	-	26	-	42	8.5	6.5	9	3	013	○
M12X1	P2	11	11.09	SPQ012M	2.5P	82	-	26	-	42	8.5	6.5	9	3	013	○
	P3(P2+20)	11	11.09	SPR012M	2.5P	82	-	26	-	42	8.5	6.5	9	3	013	○
	P4(P2+40)	11	11.09	SPS012M	2.5P	82	-	26	-	42	8.5	6.5	9	3	013	○
M12X0.75	P2	11.3	11.33	SPQ012J	2.5P	82	-	14	-	42	8.5	6.5	9	3	020	○
M12X0.5	P2	11.5	11.56	SPQ012G	2.5P	82	-	12	-	42	8.5	6.5	9	3	020	○
M13X1.75	P2	11.3	11.4	SPQ013P	2.5P	88	-	26	-	45	10.5	8	11	3	013	○
M13X1.5	P2	11.5	11.6	SPQ013O	2.5P	88	-	26	-	45	10.5	8	11	3	013	○
M13X1.25	P2	11.8	11.85	SPQ013N	2.5P	88	-	26	-	45	10.5	8	11	3	013	○
M13X1	P2	12	12.09	SPQ013M	2.5P	88	-	26	-	45	10.5	8	11	3	013	●
M14X1.5	P2	12.5	12.6	SPQ014O	2.5P	88	-	26	-	45	10.5	8	11	3	013	○
	P3(P2+20)	12.5	12.6	SPR014O	2.5P	88	-	26	-	45	10.5	8	11	3	013	○
	P4(P2+40)	12.5	12.6	SPS014O	2.5P	88	-	26	-	45	10.5	8	11	3	013	○
M14X1.25	P2	12.8	12.85	SPQ014N	2.5P	88	-	26	-	45	10.5	8	11	3	013	○
M14X1	P2	13	13.09	SPQ014M	2.5P	88	-	26	-	45	10.5	8	11	3	013	○
M15X2	P2	13	13.12	SPQ015Q	2.5P	95	-	26	-	48	12.5	10	13	3	013	○
M15X1.5	P2	13.5	13.6	SPQ015O	2.5P	95	-	26	-	48	12.5	10	13	3	013	●
M15X1	P2	14	14.09	SPQ015M	2.5P	95	-	26	-	48	12.5	10	13	3	013	●
M16X1.5	P2	14.5	14.6	SPQ016O	2.5P	95	-	26	-	48	12.5	10	13	3	013	○
	P3(P2+20)	14.5	14.6	SPR016O	2.5P	95	-	26	-	48	12.5	10	13	3	013	○
	P4(P2+40)	14.5	14.6	SPS016O	2.5P	95	-	26	-	48	12.5	10	13	3	013	○
M16X1.25	P2	14.8	14.85	SPQ016N	2.5P	95	-	26	-	48	12.5	10	13	3	013	○

Intro

SP

JIS

SL

PO

ST

ROLL

CARBIDE

LONG

HAND
TAPS

EG (STI)

SPECIAL
THREADS,
GAUGESTHREAD
MILLS

DIES



CENTER
DRILLSTechnical
info

Spiral Fluted Taps

Intro

	MF	TCTR (tolerance)	∅ (mm)	Hole ∅ (mm)	Code	THCHT (chamfer)	LF (mm)	LT (mm)	THL (mm)	LU (mm)	LS (mm)	DCON (mm)	K (mm)	LK (mm)	NOF	Type	Stock
	JIS																
SP	M16X1	P2	15	15.09	SPQ016M	2.5P	95	-	26	-	48	12.5	10	13	3	013	○
	M17X1.5	P2	15.5	15.6	SPQ0170	2.5P	100	-	33	-	51	14	11	14	4	013	●
JIS	M17X1	P2	16	16.09	SPQ017M	2.5P	100	-	18	-	51	14	11	14	4	020	●
	M18X2	P3	16	16.12	SPR018Q	2.5P	100	-	33	-	51	14	11	14	4	013	○
SL	M18X1.5	P2	16.5	16.6	SPQ0180	2.5P	100	-	33	-	51	14	11	14	4	013	○
		P3(P2+20)	16.5	16.6	SPR0180	2.5P	100	-	33	-	51	14	11	14	4	013	○
		P4(P2+40)	16.5	16.6	SPS0180	2.5P	100	-	33	-	51	14	11	14	4	013	○
PO	M18X1.25	P2	16.8	16.85	SPQ018N	2.5P	100	-	33	-	51	14	11	14	4	013	○
	M18X1	P2	17	17.09	SPQ018M	2.5P	100	-	18	-	51	14	11	14	4	020	○
	M19X1.5	P3	17.5	17.6	SPR0190	2.5P	105	-	33	-	50	15	12	15	4	013	○
ST	M19X1	P2	18	18.09	SPQ019M	2.5P	105	-	18	-	50	15	12	15	4	020	●
	M20X2	P3	18	18.12	SPR020Q	2.5P	105	-	33	-	50	15	12	15	4	013	○
	M20X1.5	P3	18.5	18.6	SPR0200	2.5P	105	-	33	-	50	15	12	15	4	013	○
P4(P3+20)		18.5	18.6	SPS0200	2.5P	105	-	33	-	50	15	12	15	4	013	○	
ROLL	M20X1.25	P2	18.8	18.85	SPQ020N	2.5P	105	-	18	-	50	15	12	15	4	020	○
		P2	19	19.09	SPQ020M	2.5P	105	-	18	-	50	15	12	15	4	020	○
	M22X2	P3	20	20.12	SPR022Q	2.5P	115	-	33	-	55	17	13	16	4	013	○
CARBIDE	M22X1.5	P3	20.5	20.6	SPR0220	2.5P	115	-	33	-	55	17	13	16	4	013	○
		P4(P3+20)	20.5	20.6	SPS0220	2.5P	115	-	33	-	55	17	13	16	4	013	○
	P5(P3+40)	20.5	20.6	SPT0220	2.5P	115	-	33	-	55	17	13	16	4	013	○	
LONG	M22X1	P2	21	21.09	SPQ022M	2.5P	115	-	19	-	55	17	13	16	4	020	○
	M23X1.5	P3	21.5	21.6	SPR0230	2.5P	120	-	39	-	55	19	15	18	4	013	○
	M24X2	P3	22	22.12	SPR024Q	2.5P	120	-	39	-	55	19	15	18	4	013	○
HAND TAPS	M24X1.5	P3	22.5	22.6	SPR0240	2.5P	120	-	39	-	55	19	15	18	4	013	○
		P4(P3+20)	22.5	22.6	SPS0240	2.5P	120	-	39	-	55	19	15	18	4	013	○
	M24X1	P2	23	23.09	SPQ024M	2.5P	120	-	19	-	55	19	15	18	4	020	○
EG (STI)	M25X2	P3	23	23.12	SPR025Q	2.5P	125	-	39	-	58	19	15	18	4	013	○
	M25X1.5	P3	23.5	23.6	SPR0250	2.5P	125	-	39	-	58	19	15	18	4	013	○
	M25X1	P2	24	24.09	SPQ025M	2.5P	125	-	20	-	58	19	15	18	4	020	○
SPECIAL THREADS, GAUGES	M26X3	P3	23	23.12	SPR026S	2.5P	130	-	39	-	60	20	15	18	4	013	○
	M26X2	P3	24	24.12	SPR026Q	2.5P	130	-	39	-	60	20	15	18	4	013	○
	M26X1.5	P3	24.5	24.6	SPR0260	2.5P	130	-	39	-	60	20	15	18	4	013	○
THREAD MILLS	M26X1	P2	25	25.09	SPQ026M	2.5P	130	-	20	-	60	20	15	18	4	020	○
	M27X2	P3	25	25.12	SPR027Q	2.5P	130	-	39	-	60	20	15	18	4	013	○
	M27X1.5	P3	25.5	25.6	SPR0270	2.5P	130	-	39	-	60	20	15	18	4	013	○
DIES	M27X1	P2	26	26.09	SPQ027M	2.5P	130	-	20	-	60	20	15	18	4	020	○
	M28X2	P3	26	26.12	SPR028Q	2.5P	135	-	46	-	62	23	17	20	4	013	○
	M28X1.5	P3	26.5	26.6	SPR0280	2.5P	135	-	46	-	62	23	17	20	4	013	○
CENTER DRILLS	M28X1	P2	27	27.09	SPQ028M	2.5P	135	-	20	-	62	23	17	20	4	020	○
	M30X3	P3	27	27.13	SPR030S	2.5P	135	-	46	-	62	23	17	20	4	013	○
	M30X2	P3	28	28.12	SPR030Q	2.5P	135	-	46	-	62	23	17	20	4	013	○
TECHNICAL INFO	M30X1.5	P3	28.5	28.6	SPR0300	2.5P	135	-	46	-	62	23	17	20	4	013	○
	M30X1	P2	29	29.09	SPQ030M	2.5P	135	-	21	-	62	23	17	20	4	020	○
	M32X3	P3	29	29.13	SPMR032S	2.5P	145	-	46	-	67	24	19	22	4	013	○
TECHNICAL INFO	M32X2	P3	30	30.12	SPMR032Q	2.5P	145	-	46	-	67	24	19	22	4	013	○
	M32X1.5	P3	30.5	30.6	SPMR0320	2.5P	145	-	46	-	67	24	19	22	4	013	○

Technical info

MF	TCTR (tolerance)	 Hole Ø (mm)	Hole Ø (mm)	Code	THCHT (chamfer)	LF (mm)	LT (mm)	THL (mm)	LU (mm)	LS (mm)	DCON (mm)	K (mm)	LK (mm)	NOF	Type	Stock
JIS																
M32X1	P2	31	31.09	SPMQ032M	2.5P	145	-	21	-	67	24	19	22	4	020	○
M33X3	P3	30	30.13	SPMR033S	2.5P	145	-	46	-	67	25	19	22	4	013	○
M33X2	P3	31	31.12	SPMR033Q	2.5P	145	-	46	-	67	25	19	22	4	013	○
M33X1.5	P3	31.5	31.6	SPMR033O	2.5P	145	-	46	-	67	25	19	22	4	013	○
M33X1	P2	32	32.09	SPMQ033M	2.5P	145	-	21	-	67	25	19	22	4	020	○
M34X3	P3	31	31.13	SPMR034S	2.5P	155	-	52	-	71	28	21	24	4	013	○
M34X2	P3	32	32.12	SPMR034Q	2.5P	155	-	52	-	71	28	21	24	4	013	○
M34X1.5	P3	35.5	32.6	SPMR034O	2.5P	155	-	26	-	71	28	21	24	4	020	○
M34X1	P2	33	33.09	SPMQ034M	2.5P	155	-	26	-	71	28	21	24	4	020	○
M35X3	P3	32	32.13	SPMR035S	2.5P	155	-	52	-	71	28	21	24	4	013	○
M35X2	P3	33	33.12	SPMR035Q	2.5P	155	-	52	-	71	28	21	24	4	013	○
M35X1.5	P3	33.5	33.6	SPMR035O	2.5P	155	-	26	-	71	28	21	24	4	020	○
M35X1	P2	34	34.09	SPMQ035M	2.5P	155	-	26	-	71	28	21	24	4	020	○
M36X3	P3	33	33.13	SPMR036S	2.5P	155	-	52	-	71	28	21	24	4	013	○
M36X2	P3	34	34.12	SPMR036Q	2.5P	155	-	52	-	71	28	21	24	4	013	○
M36X1.5	P3	34.5	34.6	SPMR036O	2.5P	155	-	26	-	71	28	21	24	4	020	○
M36X1	P2	35	35.09	SPMQ036M	2.5P	155	-	26	-	71	28	21	24	4	020	○
M38X3	P3	35	35.13	SPMR038S	2.5P	165	-	52	-	76	30	23	26	4	013	○
M38X2	P3	36	36.12	SPMR038Q	2.5P	165	-	52	-	76	30	23	26	4	013	○
M38X1.5	P3	36.5	36.6	SPMR038O	2.5P	165	-	26	-	76	30	23	26	4	020	○
M39X3	P3	36	36.13	SPMR039S	2.5P	165	-	52	-	76	30	23	26	4	013	○
M39X2	P3	37	37.12	SPMR039Q	2.5P	165	-	52	-	76	30	23	26	4	013	○
M39X1.5	P3	37.5	37.6	SPMR039O	2.5P	165	-	26	-	76	30	23	26	4	020	○
M40X3	P3	37	37.13	SPMR040S	2.5P	175	-	59	-	81	32	26	30	4	013	○
M40X2	P3	38	38.12	SPMR040Q	2.5P	175	-	59	-	81	32	26	30	4	013	○
M40X1.5	P3	38.5	38.6	SPMR040O	2.5P	175	-	27	-	81	32	26	30	4	020	○
M42X3	P3	39	39.13	SPMR042S	2.5P	175	-	59	-	81	32	26	30	4	013	○
M42X2	P3	40	40.12	SPMR042Q	2.5P	175	-	59	-	81	32	26	30	4	013	○
M42X1.5	P3	40.5	40.6	SPMR042O	2.5P	175	-	27	-	81	32	26	30	4	020	○
M45X3	P3	42	42.13	SPMR045S	2.5P	180	-	59	-	83	35	26	30	4	013	○
M45X2	P3	43	43.12	SPMR045Q	2.5P	180	-	59	-	83	35	26	30	4	013	○
M45X1.5	P3	43.5	43.6	SPMR045O	2.5P	180	-	27	-	83	35	26	30	4	020	○
M48X4	P4	44	44.12	SPMS048U	2.5P	185	-	65	-	85	38	29	32	4	013	○
M48X3	P3	45	45.13	SPMR048S	2.5P	185	-	65	-	85	38	29	32	4	013	○
M48X2	P3	46	46.12	SPMR048Q	2.5P	185	-	65	-	85	38	29	32	4	013	○
M48X1.5	P3	46.5	46.6	SPMR048O	2.5P	185	-	28	-	85	38	29	32	4	020	○
UNC																
UNC	TCTR (tolerance)	 Hole Ø (mm)	Hole Ø (mm)	Code	THCHT (chamfer)	LF (mm)	LT (mm)	THL (mm)	LU (mm)	LS (mm)	DCON (mm)	K (mm)	LK (mm)	NOF	Type	Stock
JIS																
No.1-64UNC	P1	1.54	1.55	SPPUN1D	2.5P	42	-	7.2	-	27	3	2.5	5	2	007	○
No.2-56UNC	P1	1.8	1.83	SPPUN2E	2.5P	42	-	8.1	12	27	3	2.5	5	2	001	●
No.3-48UNC	P1	2.09	2.1	SPPUN3F	2.5P	46	-	8.1	14	29	3	2.5	5	2	001	●
No.4-40UNC	P1	2.3	2.33	SPPUN4H	2.5P	46	-	9	14	26	4	3.2	6	2	001	●
No.5-40UNC	P1	2.6	2.64	SPPUN5H	2.5P	52	-	11	16	29	5	4	7	3	001	●
No.6-32UNC	P2	2.8	2.83	SPQUN6J	2.5P	52	-	11	16	29	5	4	7	3	001	●
No.8-32UNC	P2	3.4	3.47	SPQUN8J	2.5P	60	-	13	21	33	5.5	4.5	7	3	001	●
No.10-24UNC	P2	3.89	3.9	SPQUNAM	2.5P	60	-	13	22	33	5.5	4.5	7	3	001	●

Intro

SP

JIS

SL

PO

ST

ROLL

CARBIDE

LONG

HAND
TAPS

EG (STI)

SPECIAL
THREADS,
GAUGESTHREAD
MILLS

DIES

CENTER
DRILLSTechnical
info

Spiral Fluted Taps

Intro

	UNC	TCTR (tolerance)	 Hole Ø (mm)	Hole Ø (mm)	Code	THCHT (chamfer)	LF (mm)	LT (mm)	THL (mm)	LU (mm)	LS (mm)	DCON (mm)	K (mm)	LK (mm)	NOF	Type	Stock
	JIS																
SP	No.12-24UNC	P2	4.5	4.53	SPQUNCM	2.5P	62	-	15	26	33	6	4.5	7	3	001	●
	1/4-20UNC	P2	5.1	5.19	SPQU04N	2.5P	62	-	15	26	33	6	4.5	7	3	001	○
JIS	5/16-18UNC	P2	6.6	6.65	SPQU050	2.5P	70	-	19	-	36	6.2	5	8	3	013	○
	3/8-16UNC	P2	8	8.07	SPQU06P	2.5P	75	-	23	-	38	7	5.5	8	3	013	○
SL	7/16-14UNC	P3	9.4	9.45	SPRU07Q	2.5P	82	-	26	-	42	8.5	6.5	9	3	013	○
	1/2-13UNC	P3	10.9	10.91	SPRU08R	2.5P	88	-	26	-	45	10.5	8	11	3	013	○
PO	9/16-12UNC	P3	12.2	12.33	SPRU09S	2.5P	95	-	26	-	48	12.5	10	13	3	013	○
	5/8-11UNC	P3	13.6	13.75	SPRU10U	2.5P	95	-	26	-	48	12.5	10	13	3	013	○
ST	3/4-10UNC	P3	16.6	16.7	SPRU12V	2.5P	105	-	33	-	50	15	12	15	4	013	○
	7/8-9UNC	P3	19.6	19.61	SPRU14W	2.5P	115	-	33	-	55	17	13	16	4	013	○
ROLL	1-8UNC	P3	22.3	22.45	SPRU16X	2.5P	125	-	39	-	58	19	15	18	4	013	○
	1 1/8-7UNC	P4	25	25.17	SPSU18Y	2.5P	135	-	46	-	62	23	17	20	4	013	○
ST	1 1/4-7UNC	P4	28.2	28.35	SPMSU20Y	2.5P	145	-	46	-	67	24	19	22	4	013	○
	1 3/8-6UNC	P4	30.8	30.92	SPMSU22Z	2.5P	155	-	52	-	71	28	21	24	4	013	○
ROLL	1 1/2-6UNC	P4	34	34.1	SPMSU24Z	2.5P	165	-	52	-	76	30	23	26	4	013	○
	1 3/4-5UNC	P4	39.5	39.61	SPMSU280	2.5P	180	-	59	-	83	35	26	30	4	013	○
	2-4.5UNC	P5	45.2	45.37	SPTU329	2.5P	195	-	70	-	85	40	32	35	4	013	○

CARBIDE

	UNF	TCTR (tolerance)	 Hole Ø (mm)	Hole Ø (mm)	Code	THCHT (chamfer)	LF (mm)	LT (mm)	THL (mm)	LU (mm)	LS (mm)	DCON (mm)	K (mm)	LK (mm)	NOF	Type	Stock
	JIS																
LONG	No.2-64UNF	P1	1.85	1.87	SPPUN2D	2.5P	42	-	8.1	12	27	3	2.5	5	2	001	●
	No.3-56UNF	P1	2.1	2.15	SPPUN3E	2.5P	46	-	8.1	14	29	3	2.5	5	2	001	●
HAND TAPS	No.4-48UNF	P1	2.4	2.41	SPPUN4F	2.5P	46	-	9	14	26	4	3.2	6	2	001	●
	No.5-44UNF	P1	2.7	2.69	SPPUN5G	2.5P	52	-	11	16	29	5	4	7	3	001	●
EG (STI)	No.6-40UNF	P1	2.9	2.97	SPPUN6H	2.5P	52	-	11	16	29	5	4	7	3	001	●
	No.8-36UNF	P2	3.5	3.55	SPQUN8I	2.5P	60	-	13	21	33	5.5	4.5	7	3	001	●
SPECIAL THREADS, GAUGES	No.10-32UNF	P2	4.1	4.12	SPQUNAJ	2.5P	60	-	13	22	33	5.5	4.5	7	3	001	●
	No.12-28UNF	P2	4.6	4.67	SPQUNCK	2.5P	62	-	15	26	33	6	4.5	7	3	001	●
THREAD MILLS	1/4-28UNF	P2	5.5	5.53	SPQU04K	2.5P	62	-	15	26	33	6	4.5	7	3	001	○
	5/16-24UNF	P2	6.9	6.97	SPQU05M	2.5P	70	-	19	-	36	6.2	5	8	3	013	○
DIES	3/8-24UNF	P2	8.5	8.57	SPQU06M	2.5P	75	-	23	-	38	7	5.5	8	3	013	○
	7/16-20UNF	P2	9.9	9.96	SPQU07N	2.5P	82	-	26	-	42	8.5	6.5	9	3	013	○
DIES	1/2-20UNF	P2	11.5	11.54	SPQU08N	2.5P	88	-	26	-	45	10.5	8	11	3	013	○
	9/16-18UNF	P2	12.9	13	SPQU09O	2.5P	95	-	26	-	48	12.5	10	13	3	013	○
DIES	5/8-18UNF	P2	14.5	14.6	SPQU100	2.5P	95	-	26	-	48	12.5	10	13	3	013	○
	3/4-16UNF	P3	17.5	17.59	SPRU12P	2.5P	105	-	33	-	50	15	12	15	4	013	○
DIES	7/8-14UNF	P3	20.5	20.57	SPRU14Q	2.5P	115	-	33	-	55	17	13	16	4	013	○
	1-12UNF	P3	23.3	23.46	SPRU16S	2.5P	125	-	39	-	58	19	15	18	4	013	○
DIES	1 1/8-12UNF	P3	26.5	26.63	SPRU18S	2.5P	135	-	46	-	62	23	17	20	4	013	○
	1 1/4-12UNF	P3	29.6	29.81	SPMRU20S	2.5P	145	-	46	-	67	24	19	22	4	013	○
DIES	1 3/8-12UNF	P3	32.8	32.98	SPMRU22S	2.5P	155	-	52	-	71	28	21	24	4	013	○
	1 1/2-12UNF	P3	36	36.16	SPMRU24S	2.5P	165	-	52	-	76	30	23	26	4	013	○

CENTER DRILLS

	UNS	TCTR (tolerance)	 Hole Ø (mm)	Hole Ø (mm)	Code	THCHT (chamfer)	LF (mm)	LT (mm)	THL (mm)	LU (mm)	LS (mm)	DCON (mm)	K (mm)	LK (mm)	NOF	Type	Stock
	JIS																
CENTER DRILLS	1-14UNS	P3	23.6	23.7	SPRU16Q	2.5P	125	-	39	-	58	19	15	18	4	013	○
	1 1/8-14UNS	P3	26.75	26.8	SPRU18Q	2.5P	135	-	46	-	62	23	17	20	4	013	○

Technical info

8UN	TCTR (tolerance)	 Hole Ø (mm)	Hole Ø (mm)	Code	THCHT (chamfer)	LF (mm)	LT (mm)	THL (mm)	LU (mm)	LS (mm)	DCON (mm)	K (mm)	LK (mm)	NOF	Type	Stock
JIS																
1 1/8-8UN	P3	25.5	25.62	SPRU18X	2.5P	135	-	46	-	62	23	17	20	4	013	○
1 1/4-8UN	P3	28.5	28.8	SPMRU20X	2.5P	145	-	46	-	67	24	19	22	4	013	○
1 3/8-8UN	P3	31.8	31.97	SPMRU22X	2.5P	155	-	52	-	71	28	21	24	4	013	○
1 1/2-8UN	P3	35	35.15	SPMRU24X	2.5P	165	-	52	-	76	30	23	26	4	013	○
12UN																
JIS																
1 3/4-12UN	P3	42.3	42.51	SPMRU28S	2.5P	180	-	59	-	83	35	26	30	4	013	○
2 -12UN	P3	48.6	48.86	SPRU32S	2.5P	145	-	45	-	82	40	32	35	4	013	○
UNEF																
JIS																
1/4-32UNEF	P2	5.6	5.64	SPQU04J	2.5P	62	-	15	26	33	6	4.5	7	3	001	●
5/16-32UNEF	P2	7.1	7.22	SPQU05J	2.5P	70	-	19	-	36	6.2	5	8	3	013	●
3/8-32UNEF	P2	8.7	8.81	SPQU06J	2.5P	75	-	13	-	38	7	5.5	8	3	020	●
7/16-28UNEF	P2	10.2	10.29	SPQU07K	2.5P	82	-	26	-	42	8.5	6.5	9	3	013	●
1/2-28UNEF	P2	11.8	11.88	SPQU08K	2.5P	88	-	26	-	45	10.5	8	11	3	013	○
9/16-24UNEF	P2	13.2	13.32	SPQU09M	2.5P	95	-	26	-	48	12.5	10	13	3	013	●
5/8-24UNEF	P2	14.8	14.92	SPQU10M	2.5P	95	-	26	-	48	12.5	10	13	3	013	●
3/4-20UNEF	P2	17.8	17.89	SPQU12N	2.5P	105	-	33	-	50	15	12	15	4	013	●
7/8-20UNEF	P2	21	21.06	SPQU14N	2.5P	115	-	33	-	55	17	13	16	4	013	○
1 -20UNEF	P2	24.1	24.24	SPQU16N	2.5P	125	-	39	-	58	19	15	18	4	013	○
BSW																
JIS																
1/8W40	P1	2.55	2.56	SPPW02H	2.5P	52	-	11	17	29	5	4	7	3	001	●
5/32W32	P2	3.15	3.2	SPQW2HJ	2.5P	52	-	11	17	29	5	4	7	3	001	●
3/16W24	P2	3.7	3.7	SPQW03M	2.5P	60	-	13	21	33	5.5	4.5	7	3	001	●
7/32W24	P2	4.5	4.52	SPQW3HM	2.5P	62	-	15	26	33	6	4.5	7	3	001	●
1/4W20	P2	5.1	5.13	SPQW04N	2.5P	62	-	15	26	33	6	4.5	7	3	001	●
5/16W18	P2	6.5	6.59	SPQW05O	2.5P	70	-	19	-	36	6.2	5	8	3	013	●
3/8W16	P2	8	8.02	SPQW06P	2.5P	75	-	23	-	38	7	5.5	8	3	013	●
7/16W14	P3	9.3	9.39	SPRW07Q	2.5P	82	-	26	-	42	8.5	6.5	9	3	013	●
1/2W12	P3	10.6	10.7	SPRW08S	2.5P	88	-	26	-	45	10.5	8	11	3	013	●
9/16W12	P3	12.25	12.29	SPRW09S	2.5P	95	-	26	-	48	12.5	10	13	3	013	●
5/8W11	P3	13.5	13.68	SPRW10U	2.5P	95	-	26	-	48	12.5	10	13	3	013	●
3/4W10	P3	16.5	16.63	SPRW12V	2.5P	105	-	33	-	50	15	12	15	4	013	●
7/8W9	P3	19.5	19.53	SPRW14W	2.5P	115	-	33	-	55	17	13	16	4	013	●
1 W8	P3	22.2	22.34	SPRW16X	2.5P	125	-	39	-	58	19	15	18	4	013	●
1 1/8W7	P4	24.75	25.04	SPSW18Y	2.5P	135	-	46	-	62	23	17	20	4	013	○
1 1/4W7	P4	28	28.21	SPMSW20Y	2.5P	145	-	46	-	67	24	19	22	4	013	○
1 3/8W6	P4	30.5	30.72	SPMSW22Z	2.5P	155	-	52	-	71	28	21	24	4	013	○
1 1/2W6	P4	33.75	33.9	SPMSW24Z	2.5P	165	-	52	-	76	30	23	26	4	013	○
1 5/8W5	P4	36	36.19	SPMSW26O	2.5P	175	-	59	-	81	32	26	30	4	013	○
1 3/4W5	P4	39.2	39.36	SPMSW28O	2.5P	180	-	59	-	83	35	26	30	4	013	○
1 7/8W4 1/2	P4	41.8	42	SPMSW309	2.5P	185	-	65	-	85	38	29	32	4	013	○
2 W4 1/2	P4	45	45.15	SPSW329	2.5P	195	-	70	-	85	40	32	35	4	013	○

Intro

SP

JIS

SL

PO

ST

ROLL

CARBIDE

LONG

HAND TAPS

EG (STI)

SPECIAL THREADS, GAUGES

THREAD MILLS

DIES

CENTER DRILLS

Technical info

Intro

SP 1.5P

GP General Purpose Series

Spiral Fluted Taps 1.5P

SP

JIS

SL



PO

Recommended Tapping Speeds Depending On Materials

ISO	Vc (m/min)	ISO	Vc (m/min)
P1	5÷10 ☆	N1	5÷10 ☆
P2	5÷10 ★	N2	5÷10 ☆
P3	5÷10 ☆	N3	5÷10 ☆
P4	5÷8 ☆	N4	5÷10 ☆

★ 1st choice ☆ suitable

ST

ROLL

CARBIDE

LONG

HAND TAPS

EG (STI)

SPECIAL THREADS, GAUGES

THREAD MILLS

DIES

CENTER DRILLS

Technical info





FEATURES

General purpose for blind hole application.

For tapping steel at medium-low cutting speed, also suitable for non-ferrous materials.

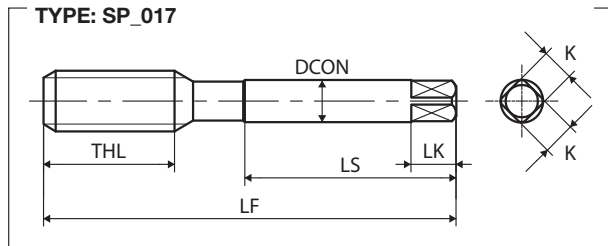
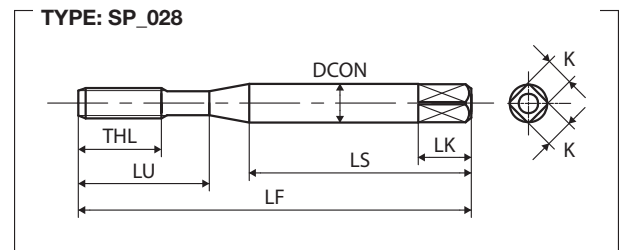
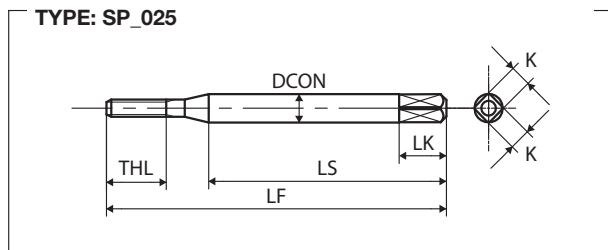
1.5P extra short chamfer for tapping till the bottom of the hole.



M	TCTR (tolerance)	 Hole Ø (mm)	Hole Ø (mm)	Code	THCHT (chamfer)	LF (mm)	LT (mm)	THL (mm)	LU (mm)	LS (mm)	DCON (mm)	K (mm)	LK (mm)	NOF	Type	Stock
JIS																
M1.2X0.25	P1	0.95	0.97	SY1.2BPNEBA	1.5P	36	-	4.5	-	24	3	2.5	5	2	025	○
M1.4X0.3	P1	1.1	1.13	SY1.4CPNEBA	1.5P	36	-	5.4	-	24	3	2.5	5	2	025	○
M1.6X0.35	P1	1.25	1.3	SY1.6DPNEBA	1.5P	36	-	6.3	-	24	3	2.5	5	2	025	○
M1.7X0.35	P1	1.35	1.4	SY1.7DPNEBA	1.5P	36	-	6.3	-	24	3	2.5	5	2	025	○
M1.8X0.35	P1	1.45	1.5	SY1.8DPNEBA	1.5P	42	-	6.3	-	27	3	2.5	5	2	025	○
M2X0.4	P1	1.6	1.65	SY2.0EPNEBA	1.5P	42	-	7.2	12	27	3	2.5	5	2	028	●
M2.3X0.4	P1	1.9	1.95	SY2.3EPNEBA	1.5P	42	-	7.2	12	27	3	2.5	5	2	028	○
M2.5X0.45	P1	2.1	2.11	SY2.5FPNEBA	1.5P	46	-	8.1	14	29	3	2.5	5	2	028	●
M2.6X0.45	P1	2.2	2.21	SY2.6FPNEBA	1.5P	46	-	8.1	14	29	3	2.5	5	2	028	●
M3X0.5	P1	2.5	2.56	SY3.0GPNEBA	1.5P	46	-	9	14	26	4	3.2	6	3	028	●
M3.5X0.6	P1	2.9	2.97	SY3.5HPNEBA	1.5P	52	-	11	16	29	5	4	7	3	028	●
M4X0.7	P2	3.3	3.38	SY4.0IQNEBA	1.5P	52	-	11	17	29	5	4	7	3	028	●
M5X0.8	P2	4.2	4.28	SY5.0KQNEBA	1.5P	60	-	13	22	33	5.5	4.5	7	3	028	●
M6X1	P2	5	5.09	SY6.0MQNEBA	1.5P	62	-	15	26	33	6	4.5	7	3	028	●
M8X1.25	P2	6.8	6.85	SY8.0NQNEBA	1.5P	70	-	19	-	36	6.2	5	8	3	017	●
M10X1.5	P2	8.5	8.6	SY0100QNEBA	1.5P	75	-	23	-	38	7	5.5	8	3	017	●
M12X1.75	P2	10.3	10.36	SY012PQNEBA	1.5P	82	-	26	-	42	8.5	6.5	9	3	017	●
M14X2	P2	12	12.12	SY014QQNEBA	1.5P	88	-	26	-	45	10.5	8	11	3	017	●
M16X2	P2	14	14.12	SY016QQNEBA	1.5P	95	-	26	-	48	12.5	10	13	3	017	●

MF	TCTR (tolerance)	 Hole Ø (mm)	Hole Ø (mm)	Code	THCHT (chamfer)	LF (mm)	LT (mm)	THL (mm)	LU (mm)	LS (mm)	DCON (mm)	K (mm)	LK (mm)	NOF	Type	Stock
JIS																
M8X1	P2	7	7.09	SY8.0MQNEBA	1.5P	70	-	19	-	36	6.2	5	8	3	017	○
M10X1.25	P2	8.8	8.85	SY010NQNEBA	1.5P	75	-	23	-	38	7	5.5	8	3	017	○
M10X1	P2	9	9.09	SY010MQNEBA	1.5P	75	-	23	-	38	7	5.5	8	3	017	○
M12X1.5	P2	10.5	10.6	SY0120QNEBA	1.5P	82	-	26	-	42	8.5	6.5	9	3	017	○
M12X1.25	P2	10.8	10.85	SY012NQNEBA	1.5P	82	-	26	-	42	8.5	6.5	9	3	017	○
M12X1	P2	11	11.09	SY012MQNEBA	1.5P	82	-	26	-	42	8.5	6.5	9	3	017	○
M14X1.5	P2	12.5	12.6	SY0140QNEBA	1.5P	88	-	26	-	45	10.5	8	11	3	017	○
M16X1.5	P2	14.5	14.6	SY0160QNEBA	1.5P	95	-	26	-	48	12.5	10	13	3	017	○

Intro

SP

JIS

SL

PO

ST

ROLL

CARBIDE

LONG

HAND TAPS

EG (STI)

SPECIAL THREADS, GAUGES

THREAD MILLS

DIES

CENTER DRILLS

Technical info

Intro

SP LH

GP General Purpose Series

Spiral Fluted Taps for Left Hand Threads

SP

JIS

SL

PO

ST

ROLL

CARBIDE

LONG

HAND TAPS

EG (STI)

SPECIAL THREADS, GAUGES

THREAD MILLS

DIES

CENTER DRILLS

Technical info



FEATURES

General purpose for blind hole application.

For tapping steel at medium-low cutting speed, also suitable for non-ferrous materials.

For left hand threads.

Recommended Tapping Speeds Depending On Materials

ISO	Vc (m/min)	ISO	Vc (m/min)
P1	5÷10 ☆	N1	5÷10 ☆
P2	5÷10 ★	N2	5÷10 ☆
P3	5÷10 ☆	N3	5÷10 ☆
P4	5÷8 ☆	N4	5÷10 ☆

★ 1st choice ☆ suitable

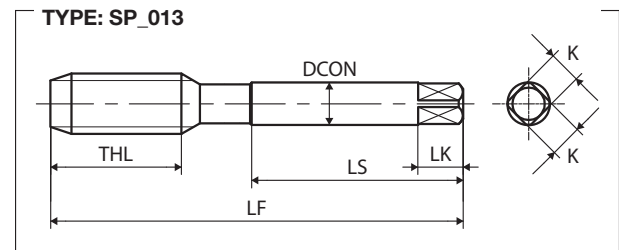
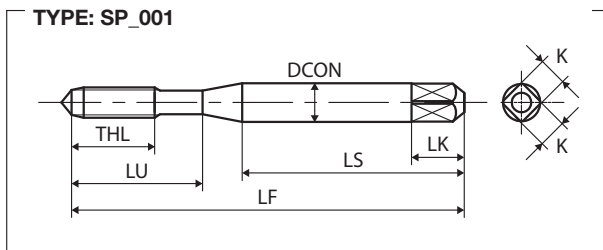

M	TCTR (tolerance)	Hole Ø (mm)	Hole Ø (mm)	Code	THCHT (chamfer)	LF (mm)	LT (mm)	THL (mm)	LU (mm)	LS (mm)	DCON (mm)	K (mm)	LK (mm)	NOF	Type	Stock
JIS																
M2X0.4	P1	1.6	1.65	SPP2.0E--L	2.5P	42	-	7.2	12	27	3	2.5	5	2	001	●
M2.3X0.4	P1	1.9	1.95	SPP2.3E--L	2.5P	42	-	7.2	12	27	3	2.5	5	2	001	○
M2.5X0.45	P1	2.1	2.11	SPP2.5F--L	2.5P	46	-	8.1	14	29	3	2.5	5	2	001	●
M2.6X0.45	P1	2.2	2.21	SPP2.6F--L	2.5P	46	-	8.1	14	29	3	2.5	5	2	001	○
M3X0.5	P1	2.5	2.56	SPP3.0G--L	2.5P	46	-	9	14	26	4	3.2	6	3	001	●
M4X0.7	P2	3.3	3.38	SPQ4.0I--L	2.5P	52	-	11	17	29	5	4	7	3	001	○
M5X0.8	P2	4.2	4.28	SPQ5.0K--L	2.5P	60	-	13	22	33	5.5	4.5	7	3	001	○
M6X1	P2	5	5.09	SPQ6.0M--L	2.5P	62	-	15	26	33	6	4.5	7	3	001	○
M7X1	P2	6	6.09	SPQ7.0M--L	2.5P	70	-	19	-	36	6.2	5	8	3	013	●
M8X1.25	P2	6.8	6.85	SPQ8.0N--L	2.5P	70	-	19	-	36	6.2	5	8	3	013	○
M10X1.5	P2	8.5	8.6	SPQ10.0--L	2.5P	75	-	23	-	38	7	5.5	8	3	013	○
M12X1.75	P2	10.3	10.36	SPQ12P--L	2.5P	82	-	26	-	42	8.5	6.5	9	3	013	○
M14X2	P2	12	12.12	SPQ14Q--L	2.5P	88	-	26	-	45	10.5	8	11	3	013	●
M16X2	P2	14	14.12	SPQ16Q--L	2.5P	95	-	26	-	48	12.5	10	13	3	013	○
M18X2.5	P3	15.5	15.63	SPR018R--L	2.5P	100	-	33	-	51	14	11	14	4	013	●
M20X2.5	P3	17.5	17.63	SPR020R--L	2.5P	105	-	33	-	50	15	12	15	4	013	○
M22X2.5	P3	19.5	19.63	SPR022R--L	2.5P	115	-	33	-	55	17	13	16	4	013	●
M24X3	P3	21	21.13	SPR024S--L	2.5P	120	-	39	-	55	19	15	18	4	013	●
M27X3	P3	24	24.13	SPR027S--L	2.5P	130	-	39	-	60	20	15	18	4	013	○
M30X3.5	P4	26.5	26.63	SPS030T--L	2.5P	135	-	46	-	62	23	17	20	4	013	○

MF	TCTR (tolerance)	 Hole Ø (mm)	Hole Ø (mm)	Code	THCHT (chamfer)	LF (mm)	LT (mm)	THL (mm)	LU (mm)	LS (mm)	DCON (mm)	K (mm)	LK (mm)	NOF	Type	Stock
JIS																
M8X1	P2	7	7.09	SPQ8.0M--L	2.5P	70	-	19	-	36	6.2	5	8	3	013	●
M10X1.25	P2	8.8	8.85	SPQ010N--L	2.5P	75	-	23	-	38	7	5.5	8	3	013	●
M10X1	P2	9	9.09	SPQ010M--L	2.5P	75	-	23	-	38	7	5.5	8	3	013	●
M12X1.5	P2	10.5	10.6	SPQ0120--L	2.5P	82	-	26	-	42	8.5	6.5	9	3	013	●
M12X1.25	P2	10.8	10.85	SPQ012N--L	2.5P	82	-	26	-	42	8.5	6.5	9	3	013	●
M12X1	P2	11	11.09	SPQ012M--L	2.5P	82	-	26	-	42	8.5	6.5	9	3	013	●
M14X1.5	P2	12.5	12.6	SPQ0140--L	2.5P	88	-	26	-	45	10.5	8	11	3	013	●
M14X1	P2	13	13.09	SPQ014M--L	2.5P	88	-	26	-	45	10.5	8	11	3	013	○
M16X1.5	P2	14.5	14.6	SPQ0160--L	2.5P	95	-	26	-	48	12.5	10	13	3	013	●
M18X1.5	P2	16.5	16.6	SPQ0180--L	2.5P	100	-	33	-	51	14	11	14	4	013	●
M20X1.5	P3	18.5	18.6	SPR0200--L	2.5P	105	-	33	-	50	15	12	15	4	013	●
M22X1.5	P3	20.5	20.6	SPR0220--L	2.5P	115	-	33	-	55	17	13	16	4	013	○
M24X2	P3	22	22.12	SPR0240--L	2.5P	120	-	39	-	55	19	15	18	4	013	○
M24X1.5	P3	22.5	22.6	SPR0240--L	2.5P	120	-	39	-	55	19	15	18	4	013	○
M27X1.5	P3	25.5	25.6	SPR0270--L	2.5P	130	-	39	-	60	20	15	18	4	013	○
M30X2	P3	28	28.12	SPR0300--L	2.5P	135	-	46	-	62	23	17	20	4	013	○
M30X1.5	P3	28.5	28.6	SPR0300--L	2.5P	135	-	46	-	62	23	17	20	4	013	○

UNC	TCTR (tolerance)	 Hole Ø (mm)	Hole Ø (mm)	Code	THCHT (chamfer)	LF (mm)	LT (mm)	THL (mm)	LU (mm)	LS (mm)	DCON (mm)	K (mm)	LK (mm)	NOF	Type	Stock
JIS																
1/4-20UNC	P2	5.1	5.19	SPQU04N--L	2.5P	62	-	15	26	33	6	4.5	7	3	001	○
5/16-18UNC	P2	6.6	6.65	SPQU050--L	2.5P	70	-	19	-	36	6.2	5	8	3	013	○
3/8-16UNC	P2	8	8.07	SPQU06P--L	2.5P	75	-	23	-	38	7	5.5	8	3	013	○
7/16-14UNC	P3	9.4	9.45	SPRU07Q--L	2.5P	82	-	26	-	42	8.5	6.5	9	3	013	○
1/2-13UNC	P3	10.9	10.91	SPRU08R--L	2.5P	88	-	26	-	45	10.5	8	11	3	013	○

UNF	TCTR (tolerance)	 Hole Ø (mm)	Hole Ø (mm)	Code	THCHT (chamfer)	LF (mm)	LT (mm)	THL (mm)	LU (mm)	LS (mm)	DCON (mm)	K (mm)	LK (mm)	NOF	Type	Stock
JIS																
1/4-28UNF	P2	5.5	5.53	SPQU04K--L	2.5P	62	-	15	26	33	6	4.5	7	3	001	○
5/16-24UNF	P2	6.9	6.97	SPQU05M--L	2.5P	70	-	19	-	36	6.2	5	8	3	013	○
3/8-24UNF	P2	8.5	8.57	SPQU06M--L	2.5P	75	-	23	-	38	7	5.5	8	3	013	○
7/16-20UNF	P2	9.9	9.96	SPQU07N--L	2.5P	82	-	26	-	42	8.5	6.5	9	3	013	○
1/2-20UNF	P2	11.5	11.54	SPQU08N--L	2.5P	88	-	26	-	45	10.5	8	11	3	013	○

BSW	TCTR (tolerance)	 Hole Ø (mm)	Hole Ø (mm)	Code	THCHT (chamfer)	LF (mm)	LT (mm)	THL (mm)	LU (mm)	LS (mm)	DCON (mm)	K (mm)	LK (mm)	NOF	Type	Stock
JIS																
1/4W20	P2	5.1	5.13	SPQW04N--L	2.5P	62	-	15	26	33	6	4.5	7	3	001	○
5/16W18	P2	6.5	6.59	SPQW050--L	2.5P	70	-	19	-	36	6.2	5	8	3	013	○
3/8W16	P2	8	8.02	SPQW06P--L	2.5P	75	-	23	-	38	7	5.5	8	3	013	○
7/16W14	P3	9.3	9.39	SPRW07Q--L	2.5P	82	-	26	-	42	8.5	6.5	9	3	013	○
1/2W12	P3	10.6	10.7	SPRW08S--L	2.5P	88	-	26	-	45	10.5	8	11	3	013	○
5/8W11	P3	13.5	13.68	SPRW10U--L	2.5P	95	-	26	-	48	12.5	10	13	3	013	○
3/4W10	P3	16.5	16.63	SPRW12V--L	2.5P	105	-	33	-	50	15	12	15	4	013	○

CENTER DRILLS

Technical info

Intro

SP

JIS

SL

PO

ST

ROLL

CARBIDE

LONG

HAND TAPS

EG (STI)

SPECIAL THREADS, GAUGES

THREAD MILLS

DIES

CENTER DRILLS

Intro

SU+SP/SU-SP



SP

MS Material Specific Series

Spiral Fluted Taps for Stainless Steel

JIS



SL

PO

Recommended Tapping Speeds Depending On Materials

ISO	Vc (m/min)	★	ISO	Vc (m/min)	★
P2	≤10	★	M1	≤10	★
P3	≤10	★			
P4	≤10	☆			
P7	≤10	★			

★ 1st choice ☆ suitable

ST

ROLL

CARBIDE

LONG

HAND TAPS

EG (STI)

SPECIAL THREADS, GAUGES

THREAD MILLS

DIES

CENTER DRILLS

Technical info

FEATURES

Material specific for blind hole application.
Most suitable for stainless steel, steel and alloy steel.
OX treatment reduces welding troubles.

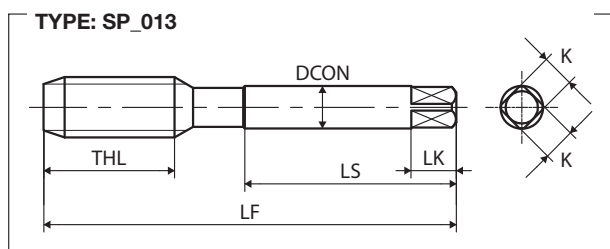
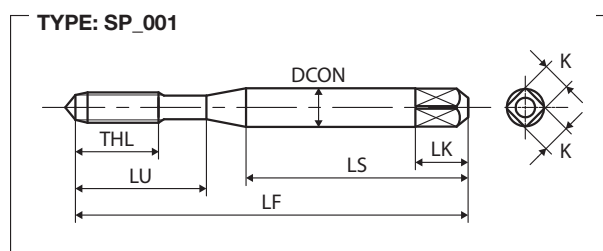
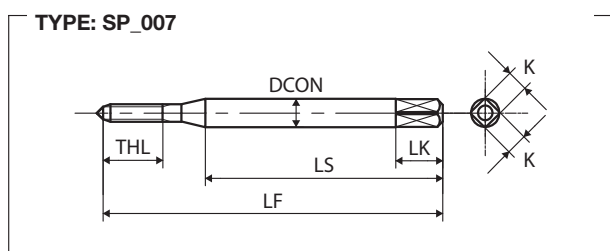

M	TCTR (tolerance)	∅ (mm)	Hole ∅ (mm)	Code	THCHT (chamfer)	LF (mm)	LT (mm)	THL (mm)	LU (mm)	LS (mm)	DCON (mm)	K (mm)	LK (mm)	NOF	Type	Stock
JIS																
M1.4X0.3	P1	1.1	1.13	SUMP1.4C	2.5P	36	-	5.4	-	24	3	2.5	5	2	007	○
M1.6X0.35	P1	1.25	1.3	SUMP1.6D	2.5P	36	-	6.3	-	24	3	2.5	5	2	007	○
M1.7X0.35	P1	1.35	1.4	SUMP1.7D	2.5P	36	-	6.3	-	24	3	2.5	5	2	007	○
	P2(P1+15)	1.35	1.4	SUMQ1.7D	2.5P	36	-	6.3	-	24	3	2.5	5	2	007	○
M2X0.4	P1	1.6	1.65	SUPP2.0E	2.5P	42	-	7.2	12	27	3	2.5	5	2	001	○
	P2(P1+15)	1.6	1.65	SUPQ2.0E	2.5P	42	-	7.2	12	27	3	2.5	5	2	001	○
	P3(P1+30)	1.6	1.65	SUPR2.0E	2.5P	42	-	7.2	12	27	3	2.5	5	2	001	○
M2.3X0.4	P1	1.9	1.95	SUPP2.3E	2.5P	42	-	7.2	12	27	3	2.5	5	2	001	●
	P2(P1+15)	1.9	1.95	SUPQ2.3E	2.5P	42	-	7.2	12	27	3	2.5	5	2	001	○
	P3(P1+30)	1.9	1.95	SUPR2.3E	2.5P	42	-	7.2	12	27	3	2.5	5	2	001	○

M	TCTR (tolerance)	\varnothing (mm)	Hole \varnothing (mm)	Code	THCHT (chamfer)	LF (mm)	LT (mm)	THL (mm)	LU (mm)	LS (mm)	DCON (mm)	K (mm)	LK (mm)	NOF	Type	Stock
JIS																
M2.5X0.45	P1	2.1	2.11	SUPP2.5F	2.5P	46	-	8.1	14	29	3	2.5	5	2	001	○
	P2(P1+15)	2.1	2.11	SUPQ2.5F	2.5P	46	-	8.1	14	29	3	2.5	5	2	001	○
	P3(P1+30)	2.1	2.11	SUPR2.5F	2.5P	46	-	8.1	14	29	3	2.5	5	2	001	○
M2.6X0.45	P1	2.2	2.21	SUPP2.6F	2.5P	46	-	8.1	14	29	3	2.5	5	2	001	●
	P2(P1+15)	2.2	2.21	SUPQ2.6F	2.5P	46	-	8.1	14	29	3	2.5	5	2	001	○
	P3(P1+30)	2.2	2.21	SUPR2.6F	2.5P	46	-	8.1	14	29	3	2.5	5	2	001	○
3M0.6	P1	2.45	2.47	SUPP3.0H	2.5P	46	-	9	14	26	4	3.2	6	3	001	○
M3X0.5	P1	2.5	2.56	SUPP3.0G	2.5P	46	-	9	14	26	4	3.2	6	3	001	○
	P2(P1+15)	2.5	2.56	SUPQ3.0G	2.5P	46	-	9	14	26	4	3.2	6	3	001	○
	P3(P1+30)	2.5	2.56	SUPR3.0G	2.5P	46	-	9	14	26	4	3.2	6	3	001	○
M3.5X0.6	P1	2.9	2.97	SUPP3.5H	2.5P	52	-	11	16	29	5	4	7	3	001	●
	P3(P1+30)	2.9	2.97	SUPR3.5H	2.5P	52	-	11	16	29	5	4	7	3	001	○
4M0.75	P2	3.3	3.33	SUPQ4.0J	2.5P	52	-	11	17	29	5	4	7	3	001	○
M4X0.7	P2	3.3	3.38	SUPQ4.0I	2.5P	52	-	11	17	29	5	4	7	3	001	○
	P3(P2+20)	3.3	3.38	SUPR4.0I	2.5P	52	-	11	17	29	5	4	7	3	001	○
	P4(P2+40)	3.3	3.38	SUPS4.0I	2.5P	52	-	11	17	29	5	4	7	3	001	○
5M0.9	P2	4.15	4.19	SUPQ5.0L	2.5P	60	-	13	22	33	5.5	4.5	7	3	001	○
M5X0.8	P2	4.2	4.28	SUPQ5.0K	2.5P	60	-	13	22	33	5.5	4.5	7	3	001	○
	P3(P2+20)	4.2	4.28	SUPR5.0K	2.5P	60	-	13	22	33	5.5	4.5	7	3	001	○
	P4(P2+40)	4.2	4.28	SUPS5.0K	2.5P	60	-	13	22	33	5.5	4.5	7	3	001	○
M6X1	P2	5	5.09	SUPQ6.0M	2.5P	62	-	15	26	33	6	4.5	7	3	001	○
	P3(P2+20)	5	5.09	SUPR6.0M	2.5P	62	-	15	26	33	6	4.5	7	3	001	○
	P4(P2+40)	5	5.09	SUPS6.0M	2.5P	62	-	15	26	33	6	4.5	7	3	001	○
M8X1.25	P2	6.8	6.85	SUMQ8.0N	2.5P	70	-	19	-	36	6.2	5	8	3	013	○
	P3(P2+20)	6.8	6.85	SUMR8.0N	2.5P	70	-	19	-	36	6.2	5	8	3	013	○
	P4(P2+40)	6.8	6.85	SUMS8.0N	2.5P	70	-	19	-	36	6.2	5	8	3	013	○
M10X1.5	P2	8.5	8.6	SUMQ10.0	2.5P	75	-	23	-	38	7	5.5	8	3	013	○
	P3(P2+20)	8.5	8.6	SUMR10.0	2.5P	75	-	23	-	38	7	5.5	8	3	013	○
	P4(P2+40)	8.5	8.6	SUMS10.0	2.5P	75	-	23	-	38	7	5.5	8	3	013	○
M12X1.75	P2	10.3	10.36	SUMQ12.0	2.5P	82	-	26	-	42	8.5	6.5	9	3	013	○
	P3(P2+20)	10.3	10.36	SUMR12.0	2.5P	82	-	26	-	42	8.5	6.5	9	3	013	○
	P4(P2+40)	10.3	10.36	SUMS12.0	2.5P	82	-	26	-	42	8.5	6.5	9	3	013	○
M14X2	P2	12	12.12	SUMQ14.0	2.5P	88	-	26	-	45	10.5	8	11	3	013	○
	P3(P2+20)	12	12.12	SUMR14.0	2.5P	88	-	26	-	45	10.5	8	11	3	013	○
	P4(P2+40)	12	12.12	SUMS14.0	2.5P	88	-	26	-	45	10.5	8	11	3	013	○
M16X2	P2	14	14.12	SUMQ16.0	2.5P	95	-	26	-	48	12.5	10	13	3	013	○
	P3(P2+20)	14	14.12	SUMR16.0	2.5P	95	-	26	-	48	12.5	10	13	3	013	○
	P4(P2+40)	14	14.12	SUMS16.0	2.5P	95	-	26	-	48	12.5	10	13	3	013	○
M18X2.5	P3	15.5	15.63	SUMR18.0	2.5P	100	-	33	-	51	14	11	14	4	013	○
	P4(P3+20)	15.5	15.63	SUMS18.0	2.5P	100	-	33	-	51	14	11	14	4	013	○
M20X2.5	P3	17.5	17.63	SUMR20.0	2.5P	105	-	33	-	50	15	12	15	4	013	○
	P4(P3+20)	17.5	17.63	SUMS20.0	2.5P	105	-	33	-	50	15	12	15	4	013	○
M22X2.5	P3	19.5	19.63	SUMR22.0	2.5P	115	-	33	-	55	17	13	16	4	013	○
	P4(P3+20)	19.5	19.63	SUMS22.0	2.5P	115	-	33	-	55	17	13	16	4	013	○
	P5(P3+40)	19.5	19.63	SUMT022R	2.5P	115	-	33	-	55	17	13	16	4	013	○

Intro

SP

JIS

SL

PO

ST

ROLL

CARBIDE

LONG

HAND
TAPS

EG (STI)



SPECIAL
THREADS,
GAUGESTHREAD
MILLS

DIES

CENTER
DRILLSTechnical
info

Spiral Fluted Taps

Intro

	M	TCTR (tolerance)	 Hole Ø (mm)	Hole Ø (mm)	Code	THCHT (chamfer)	LF (mm)	LT (mm)	THL (mm)	LU (mm)	LS (mm)	DCON (mm)	K (mm)	LK (mm)	NOF	Type	Stock
	JIS																
SP	M24X3	P3	21	21.13	SUMR024S	2.5P	120	-	39	-	55	19	15	18	4	013	○
		P4(P3+20)	21	21.13	SUMS024S	2.5P	120	-	39	-	55	19	15	18	4	013	○
		P5(P3+40)	21	21.13	SUMT024S	2.5P	120	-	39	-	55	19	15	18	4	013	○
JIS	M27X3	P3	24	24.13	SUMR027S	2.5P	130	-	39	-	60	20	15	18	4	013	○
	M30X3.5	P4	26.5	26.63	SUMS030T	2.5P	135	-	46	-	62	23	17	20	4	013	○
	M33X3.5	P4	29.5	29.63	SUMS033T	2.5P	145	-	46	-	67	25	19	22	4	013	○
SL	M36X4	P4	32	32.12	SUMS036U	2.5P	155	-	52	-	71	28	21	24	4	013	○
PO	M39X4	P4	35	35.12	SUMS039U	2.5P	165	-	52	-	76	30	23	26	4	013	○
	M42X4.5	P4	37.5	37.63	SUMS042V	2.5P	175	-	59	-	81	32	26	30	4	013	○
	M45X4.5	P4	40.5	40.63	SUMS045V	2.5P	180	-	59	-	83	35	26	30	4	013	○
	M48X5	P4	43	43.12	SUMS048W	2.5P	185	-	65	-	85	38	29	32	4	013	○
	JIS																
ST	MF	TCTR (tolerance)	 Hole Ø (mm)	Hole Ø (mm)	Code	THCHT (chamfer)	LF (mm)	LT (mm)	THL (mm)	LU (mm)	LS (mm)	DCON (mm)	K (mm)	LK (mm)	NOF	Type	Stock
	JIS																
ROLL	M6X0.75	P2	5.3	5.33	SUMQ6.0J	2.5P	62	-	15	26	33	6	4.5	7	3	001	○
	M8X1	P2	7	7.09	SUMQ8.0M	2.5P	70	-	19	-	36	6.2	5	8	3	013	○
	M8X0.75	P2	7.3	7.33	SUMQ8.0J	2.5P	70	-	19	-	36	6.2	5	8	3	013	○
CARBIDE	M10X1.25	P2	8.8	8.85	SUMQ010N	2.5P	75	-	23	-	38	7	5.5	8	3	013	○
		P3(P2+20)	8.8	8.85	SUMR010N	2.5P	75	-	23	-	38	7	5.5	8	3	013	○
		P4(P2+40)	8.8	8.85	SUMS010N	2.5P	75	-	23	-	38	7	5.5	8	3	013	○
LONG	M10X1	P2	9	9.09	SUMQ010M	2.5P	75	-	23	-	38	7	5.5	8	3	013	○
		P4(P2+40)	9	9.09	SUMS010M	2.5P	75	-	23	-	38	7	5.5	8	3	013	○
		P2	10.5	10.6	SUMQ0120	2.5P	82	-	26	-	42	8.5	6.5	9	3	013	○
HAND TAPS	M12X1.5	P3(P2+20)	10.5	10.6	SUMR0120	2.5P	82	-	26	-	42	8.5	6.5	9	3	013	○
		P4(P2+40)	10.5	10.6	SUMS0120	2.5P	82	-	26	-	42	8.5	6.5	9	3	013	○
		P2	10.8	10.85	SUMQ012N	2.5P	82	-	26	-	42	8.5	6.5	9	3	013	○
EG (STI)	M12X1	P3(P2+20)	10.8	10.85	SUMR012N	2.5P	82	-	26	-	42	8.5	6.5	9	3	013	○
		P2	11	11.09	SUMQ012M	2.5P	82	-	26	-	42	8.5	6.5	9	3	013	○
		P2	12.5	12.6	SUMQ0140	2.5P	88	-	26	-	45	10.5	8	11	3	013	○
SPECIAL THREADS, GAUGES	M14X1.5	P4(P2+40)	12.5	12.6	SUMS0140	2.5P	88	-	26	-	45	10.5	8	11	3	013	○
		P2	13	13.09	SUMQ014M	2.5P	88	-	26	-	45	10.5	8	11	3	013	○
		P2	14.5	14.6	SUMQ0160	2.5P	95	-	26	-	48	12.5	10	13	3	013	○
THREAD MILLS	M16X1.5	P4(P2+40)	14.5	14.6	SUMS0160	2.5P	95	-	26	-	48	12.5	10	13	3	013	○
		P2	16.5	16.6	SUMQ0180	2.5P	100	-	33	-	51	14	11	14	4	013	○
		P4(P2+40)	16.5	16.6	SUMS0180	2.5P	100	-	33	-	51	14	11	14	4	013	○
DIES	M20X1.5	P3	18.5	18.6	SUMR0200	2.5P	105	-	33	-	50	15	12	15	4	013	○
		P4(P3+20)	18.5	18.6	SUMS0200	2.5P	105	-	33	-	50	15	12	15	4	013	○
		P3	20.5	20.6	SUMR0220	2.5P	115	-	33	-	55	17	13	16	4	013	○
CENTER DRILLS	M22X1.5	P4(P3+20)	20.5	20.6	SUMS0220	2.5P	115	-	33	-	55	17	13	16	4	013	○
		P3	22	22.12	SUMR024Q	2.5P	120	-	39	-	55	19	15	18	4	013	○
		P3	22.5	22.6	SUMR0240	2.5P	120	-	39	-	55	19	15	18	4	013	○
DIES	M24X1.5	P4(P3+20)	22.5	22.6	SUMS0240	2.5P	120	-	39	-	55	19	15	18	4	013	○
		P3	25.5	25.6	SUMR0270	2.5P	130	-	39	-	60	20	15	18	4	013	○
		P3	28.5	28.6	SUMR0300	2.5P	135	-	46	-	62	23	17	20	4	013	○
CENTER DRILLS	M42X1.5	P3	40.5	40.6	SUMR0420	2.5P	175	-	27	-	81	32	26	30	4	013	○

Technical info

UNC	TCTR (tolerance)	 Hole Ø (mm)	Hole Ø (mm)	Code	THCHT (chamfer)	LF (mm)	LT (mm)	THL (mm)	LU (mm)	LS (mm)	DCON (mm)	K (mm)	LK (mm)	NOF	Type	Stock
JIS																
No.2-56UNC	P1	1.8	1.83	SUMPUN2E	2.5P	42	-	8.1	12	27	3	2.5	5	2	001	○
No.3-48UNC	P1	2.09	2.1	SUMPUN3F	2.5P	46	-	8.1	14	29	3	2.5	5	2	001	○
No.4-40UNC	P1	2.3	2.33	SUMPUN4H	2.5P	46	-	9	14	26	4	3.2	6	2	001	○
No.5-40UNC	P1	2.6	2.64	SUMPUN5H	2.5P	52	-	11	16	29	5	4	7	3	001	○
No.6-32UNC	P2	2.8	2.83	SUMQUN6J	2.5P	52	-	11	16	29	5	4	7	3	001	○
No.8-32UNC	P2	3.4	3.47	SUMQUN8J	2.5P	60	-	13	21	33	5.5	4.5	7	3	001	○
No.10-24UNC	P2	3.89	3.9	SUMQUNAM	2.5P	60	-	13	22	33	5.5	4.5	7	3	001	○
1/4-20UNC	P2	5.1	5.19	SUMQU04N	2.5P	62	-	15	26	33	6	4.5	7	3	001	○
5/16-18UNC	P2	6.6	6.65	SUMQU05O	2.5P	70	-	19	-	36	6.2	5	8	3	013	○
3/8-16UNC	P2	8	8.07	SUMQU06P	2.5P	75	-	23	-	38	7	5.5	8	3	013	○
7/16-14UNC	P3	9.4	9.45	SUMRU07Q	2.5P	82	-	26	-	42	8.5	6.5	9	3	013	○
1/2-13UNC	P3	10.9	10.91	SUMRU08R	2.5P	88	-	26	-	45	10.5	8	11	3	013	○
5/8-11UNC	P3	13.6	13.75	SUMRU10U	2.5P	95	-	26	-	48	12.5	10	13	3	013	○
3/4-10UNC	P3	16.6	16.7	SUMRU12V	2.5P	105	-	33	-	50	15	12	15	4	013	○
7/8-9UNC	P3	19.6	19.61	SUMRU14W	2.5P	115	-	33	-	55	17	13	16	4	013	○
1 -8UNC	P3	22.3	22.45	SUMRU16X	2.5P	125	-	39	-	58	19	15	18	4	013	○

UNF	TCTR (tolerance)	 Hole Ø (mm)	Hole Ø (mm)	Code	THCHT (chamfer)	LF (mm)	LT (mm)	THL (mm)	LU (mm)	LS (mm)	DCON (mm)	K (mm)	LK (mm)	NOF	Type	Stock
JIS																
No.4-48UNF	P1	2.4	2.41	SUMPUN4F	2.5P	46	-	9	14	26	4	3.2	6	2	001	○
No.5-44UNF	P1	2.7	2.69	SUMPUN5G	2.5P	52	-	11	16	29	5	4	7	3	001	○
No.6-40UNF	P1	2.9	2.97	SUMPUN6H	2.5P	52	-	11	16	29	5	4	7	3	001	○
No.8-36UNF	P2	3.5	3.55	SUMQUN8I	2.5P	60	-	13	21	33	5.5	4.5	7	3	001	○
No.10-32UNF	P2	4.1	4.12	SUMQUNAJ	2.5P	60	-	13	22	33	5.5	4.5	7	3	001	○
1/4-28UNF	P2	5.5	5.53	SUMQU04K	2.5P	62	-	15	26	33	6	4.5	7	3	001	○
5/16-24UNF	P2	6.9	6.97	SUMQU05M	2.5P	70	-	19	-	36	6.2	5	8	3	013	○
3/8-24UNF	P2	8.5	8.57	SUMQU06M	2.5P	75	-	23	-	38	7	5.5	8	3	013	○
7/16-20UNF	P2	9.9	9.96	SUMQU07N	2.5P	82	-	26	-	42	8.5	6.5	9	3	013	○
1/2-20UNF	P2	11.5	11.54	SUMQU08N	2.5P	88	-	26	-	45	10.5	8	11	3	013	○
5/8-18UNF	P2	14.5	14.6	SUMQU10O	2.5P	95	-	26	-	48	12.5	10	13	3	013	○
3/4-16UNF	P3	17.5	17.59	SUMRU12P	2.5P	105	-	33	-	50	15	12	15	4	013	○
7/8-14UNF	P3	20.5	20.57	SUMRU14Q	2.5P	115	-	33	-	55	17	13	16	4	013	○
1 -12UNF	P3	23.3	23.46	SUMRU16S	2.5P	125	-	39	-	58	19	15	18	4	013	○

BSW	TCTR (tolerance)	 Hole Ø (mm)	Hole Ø (mm)	Code	THCHT (chamfer)	LF (mm)	LT (mm)	THL (mm)	LU (mm)	LS (mm)	DCON (mm)	K (mm)	LK (mm)	NOF	Type	Stock
JIS																
3/16W24	P2	3.7	3.7	SUMQW03M	2.5P	60	-	13	21	33	5.5	4.5	7	3	001	○
1/4W20	P2	5.1	5.13	SUMQW04N	2.5P	62	-	15	26	33	6	4.5	7	3	001	○
5/16W18	P2	6.5	6.59	SUMQW05O	2.5P	70	-	19	-	36	6.2	5	8	3	013	○
3/8W16	P2	8	8.02	SUMQW06P	2.5P	75	-	23	-	38	7	5.5	8	3	013	○
7/16W14	P3	9.3	9.39	SUMRW07Q	2.5P	82	-	26	-	42	8.5	6.5	9	3	013	○
1/2W12	P3	10.6	10.7	SUMRW08S	2.5P	88	-	26	-	45	10.5	8	11	3	013	○
9/16W12	P3	12.25	12.29	SUMRW09S	2.5P	95	-	26	-	48	12.5	10	13	3	013	○
5/8W11	P3	13.5	13.68	SUMRW10U	2.5P	95	-	26	-	48	12.5	10	13	3	013	○
3/4W10	P3	16.5	16.63	SUMRW12V	2.5P	105	-	33	-	50	15	12	15	4	013	○
7/8W9	P3	19.5	19.53	SUMRW14W	2.5P	115	-	33	-	55	17	13	16	4	013	○
1 W8	P3	22.2	22.34	SUMRW16X	2.5P	125	-	39	-	58	19	15	18	4	013	○

Intro

AL+SP/AL-SP



SP

MS Material Specific Series

Spiral Fluted Taps for Aluminium

JIS



SL

PO

Recommended Tapping Speeds Depending On Materials

ISO	Vc (m/min)
N1	10÷25 ★
N2	10÷25 ★
N3	10÷25 ★
N4	10÷25 ★

★ 1st choice ☆ suitable

ST

ROLL

Product Features

CARBIDE

AL+SP guarantees consistent tapping even in medium-high speed cutting area, in forged workpieces of light alloys such as aluminum die castings and aluminum castings.

Featuring an optimized cutting edge design, AL+SP does not produce burrs in minor diameter which usually occurs during tapping light alloys. AL+SP ensure reliability and high quality internal threads.

LONG

Process Data

M6×1

Work-material	DIN G-AISI7Mg
Tapping length	9mm, blind hole
Tapping speed	20 m/min
Hole diameter	ø 5.0
Machine	Vertical machining center
Lubricant	Water soluble oil (x 20)

HAND TAPS

EG (STI)

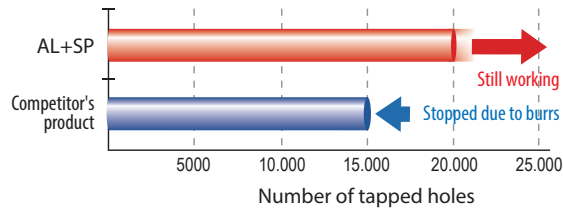

SPECIAL THREADS, GAUGES

AL+SP

Internal thread



Cross section of internal threads

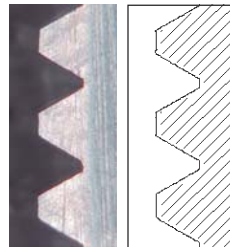

THREAD MILLS

DIES



Competitor

Internal thread

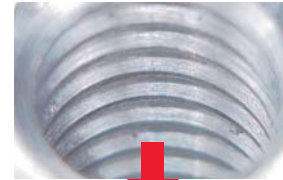

Cross section of internal threads

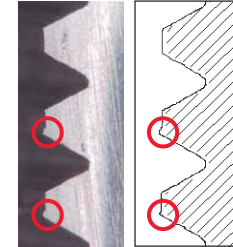

CENTER DRILLS

Compared to competitor, AL+SP assures longer tool life and higher quality internal threads

Technical info

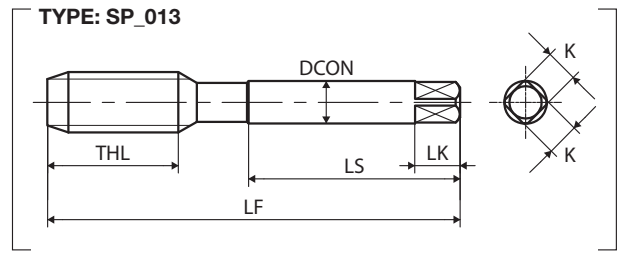
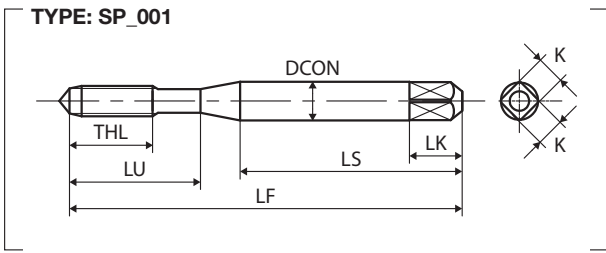

M	TCTR (tolerance)	∅ (mm)	Hole ∅ (mm)	Code	THCHT (chamfer)	LF (mm)	LT (mm)	THL (mm)	LU (mm)	LS (mm)	DCON (mm)	K (mm)	LK (mm)	NOF	Type	Stock
JIS																
M2X0.4	P2	1.6	1.65	ASHPQ2.0E	2.5P	42	-	7.2	12	27	3	2.5	5	2	001	○
M2.3X0.4	P2	1.9	1.95	ASHPQ2.3E	2.5P	42	-	7.2	12	27	3	2.5	5	2	001	○
M2.5X0.45	P2	2.1	2.11	ASHPQ2.5F	2.5P	46	-	8.1	14	29	3	2.5	5	2	001	○
M2.6X0.45	P2	2.2	2.21	ASHPQ2.6F	2.5P	46	-	8.1	14	29	3	2.5	5	2	001	○
M3X0.5	P2	2.5	2.56	ASHPQ3.0G	2.5P	46	-	9	14	26	4	3.2	6	3	001	○
M3.5X0.6	P2	2.9	2.97	ASHPQ3.5H	2.5P	52	-	11	16	29	5	4	7	3	001	○
M4X0.7	P3	3.3	3.38	ASHPR4.0I	2.5P	52	-	11	17	29	5	4	7	3	001	○
M5X0.8	P3	4.2	4.28	ASHPR5.0K	2.5P	60	-	13	22	33	5.5	4.5	7	3	001	○
M6X1	P3	5	5.09	ASHPR6.0M	2.5P	62	-	15	26	33	6	4.5	7	3	001	○
M8X1.25	P3	6.8	6.85	ASHMR8.0N	2.5P	70	-	19	-	36	6.2	5	8	3	013	○
M10X1.5	P3	8.5	8.6	ASHMR0100	2.5P	75	-	23	-	38	7	5.5	8	3	013	○
M12X1.75	P3	10.3	10.36	ASHMR012P	2.5P	82	-	26	-	42	8.5	6.5	9	3	013	○
M14X2	P3	12	12.12	ASHMR014Q	2.5P	88	-	26	-	45	10.5	8	11	3	013	○
M16X2	P3	14	14.12	ASHMR016Q	2.5P	95	-	26	-	48	12.5	10	13	3	013	○
MF	TCTR (tolerance)	∅ (mm)	Hole ∅ (mm)	Code	THCHT (chamfer)	LF (mm)	LT (mm)	THL (mm)	LU (mm)	LS (mm)	DCON (mm)	K (mm)	LK (mm)	NOF	Type	Stock
JIS																
M10X1.25	P3	8.8	8.85	ASHMR010N	2.5P	75	-	23	-	38	7	5.5	8	3	013	○
M10X1	P3	9	9.09	ASHMR010M	2.5P	75	-	23	-	38	7	5.5	8	3	013	○
M12X1.5	P3	10.5	10.6	ASHMR012O	2.5P	82	-	26	-	42	8.5	6.5	9	3	013	○
M12X1.25	P3	10.8	10.85	ASHMR012N	2.5P	82	-	26	-	42	8.5	6.5	9	3	013	○
M12X1	P3	11	11.09	ASHMR012M	2.5P	82	-	26	-	42	8.5	6.5	9	3	013	○
M14X1.5	P3	12.5	12.6	ASHMR014O	2.5P	88	-	26	-	45	10.5	8	11	3	013	○
M16X1.5	P3	14.5	14.6	ASHMR016O	2.5P	95	-	26	-	48	12.5	10	13	3	013	○

Intro

SP
JIS

SL

PO

ST

ROLL

CARBIDE

LONG

HAND
TAPS

EG (STI)

SPECIAL
THREADS,
GAUGES

THREAD
MILLS

DIES

CENTER
DRILLS

Technical
info

Intro

AL-SP 1.5P

MS Material Specific Series

Spiral Fluted Taps for Aluminium 1.5P

SP

JIS

SL



PO

Recommended Tapping Speeds Depending On Materials

ISO	Vc (m/min)
N1	10÷25 ★
N2	10÷25 ★
N3	10÷25 ★
N4	10÷25 ★

★ 1st choice ☆ suitable

ST

ROLL

CARBIDE

LONG

HAND TAPS

EG (STI)

SPECIAL THREADS, GAUGES

THREAD MILLS

DIES

CENTER DRILLS

Technical info



FEATURES

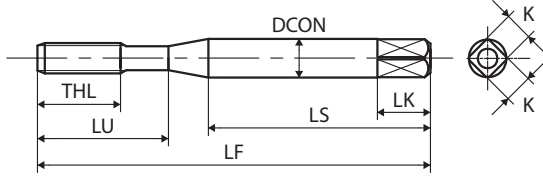

Material specific for blind hole application.
 Specific design and NI treatment allow stable and long life on Aluminium, Aluminium casting and die-casting.
 1.5P extra short chamfer for tapping till the bottom of the hole.

TYPE: SP_028

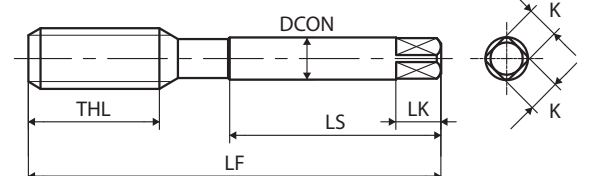

TYPE: SP_017



M	TCTR (tolerance)	 Hole Ø (mm)	Hole Ø (mm)	Code	THCHT (chamfer)	LF (mm)	LT (mm)	THL (mm)	LU (mm)	LS (mm)	DCON (mm)	K (mm)	LK (mm)	NOF	Type	Stock
JIS																
M2X0.4	P2	1.6	1.65	SY2.0EQLENA	1.5P	42	-	7.2	12	27	3	2.5	5	2	028	○
M2.3X0.4	P2	1.9	1.95	SY2.3EQLENA	1.5P	42	-	7.2	12	27	3	2.5	5	2	028	○
M2.5X0.45	P2	2.1	2.11	SY2.5FQLENA	1.5P	46	-	8.1	14	29	3	2.5	5	2	028	○
M2.6X0.45	P2	2.2	2.21	SY2.6FQLENA	1.5P	46	-	8.1	14	29	3	2.5	5	2	028	○
M3X0.5	P2	2.5	2.56	SY3.0GQLENA	1.5P	46	-	9	14	26	4	3.2	6	3	028	○
M3.5X0.6	P2	2.9	2.97	SY3.5HQLENA	1.5P	52	-	11	16	29	5	4	7	3	028	○
M4X0.7	P3	3.3	3.38	SY4.0IRLENA	1.5P	52	-	11	17	29	5	4	7	3	028	○
M5X0.8	P3	4.2	4.28	SY5.0KRLENA	1.5P	60	-	13	22	33	5.5	4.5	7	3	028	○
M6X1	P3	5	5.09	SY6.0MRLENA	1.5P	62	-	15	26	33	6	4.5	7	3	028	○
M8X1.25	P3	6.8	6.85	SY8.0NRLENA	1.5P	70	-	19	-	36	6.2	5	8	3	017	○
M10X1.5	P3	8.5	8.6	SY010ORLENA	1.5P	75	-	23	-	38	7	5.5	8	3	017	○
M12X1.75	P3	10.3	10.36	SY012PRLENA	1.5P	82	-	26	-	42	8.5	6.5	9	3	017	○
M14X2	P3	12	12.12	SY014QRLENA	1.5P	88	-	26	-	45	10.5	8	11	3	017	○
M16X2	P3	14	14.12	SY016QRLENA	1.5P	95	-	26	-	48	12.5	10	13	3	017	○
MF																
MF	TCTR (tolerance)	 Hole Ø (mm)	Hole Ø (mm)	Code	THCHT (chamfer)	LF (mm)	LT (mm)	THL (mm)	LU (mm)	LS (mm)	DCON (mm)	K (mm)	LK (mm)	NOF	Type	Stock
JIS																
M10X1.25	P3	8.8	8.85	SY010NRLENA	1.5P	75	-	23	-	38	7	5.5	8	3	017	○
M10X1	P3	9	9.09	SY010MRLENA	1.5P	75	-	23	-	38	7	5.5	8	3	017	○
M12X1.5	P3	10.5	10.6	SY012ORLENA	1.5P	82	-	26	-	42	8.5	6.5	9	3	017	○
M12X1.25	P3	10.8	10.85	SY012NRLENA	1.5P	82	-	26	-	42	8.5	6.5	9	3	017	○
M12X1	P3	11	11.09	SY012MRLENA	1.5P	82	-	26	-	42	8.5	6.5	9	3	017	○
M14X1.5	P3	12.5	12.6	SY014ORLENA	1.5P	88	-	26	-	45	10.5	8	11	3	017	○
M16X1.5	P3	14.5	14.6	SY016ORLENA	1.5P	95	-	26	-	48	12.5	10	13	3	017	○

Intro

SP

JIS

SL

PO

ST

ROLL

CARBIDE

LONG

HAND
TAPS

EG (STI)

SPECIAL
THREADS,
GAUGESTHREAD
MILLS

DIES

CENTER
DRILLSTechnical
info

Intro

SP

GP General Purpose Series

Spiral Fluted Taps

SP

ANSI

SL



PO

Recommended Tapping Speeds Depending On Materials

ISO	Vc (m/min)	ISO	Vc (m/min)
P1	5÷10 ☆	N1	5÷10 ☆
P2	5÷10 ★	N2	5÷10 ☆
P3	5÷10 ☆	N3	5÷10 ☆
P4	5÷8 ☆	N4	5÷10 ☆

★ 1st choice ☆ suitable

ST

ROLL

CARBIDE

LONG

HAND TAPS

EG (STI)

SPECIAL THREADS, GAUGES

THREAD MILLS

DIES

CENTER DRILLS

Technical info



FEATURES

General purpose for blind hole application.

For tapping steel at medium-low cutting speed, also suitable for non-ferrous materials.

TYPE: US_004

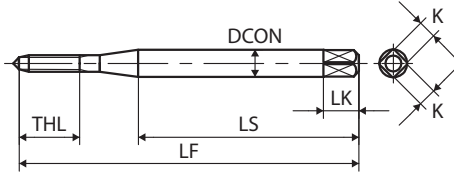

TYPE: US_005

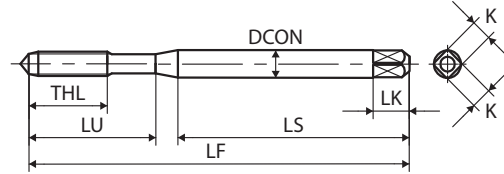

TYPE: US_006

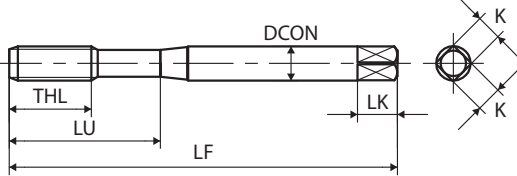

TYPE: US_007

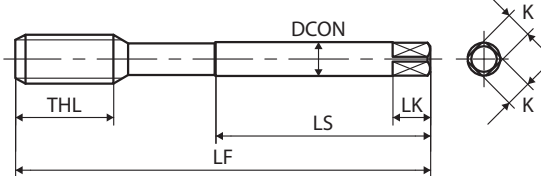

UNC	TCTR (tolerance)	∅ (mm)	Hole ∅ (mm)	Code	THCHT (chamfer)	LF (inch)	LT (inch)	THL (inch)	LU (inch)	LS (inch)	DCON (inch)	K (inch)	LK (inch)	NOF	Type	Stock
ANSI																
No.2-56UNC	GH1	1.8	1.83	SSUN2E1NEB	2.5P	1.772	-	0.314	-	1.161	0.141	0.11	0.187	2	004	○
	GH2	1.8	1.83	SSUN2E2NEB	2.5P	1.772	-	0.314	-	1.161	0.141	0.11	0.187	2	004	○
No.3-48UNC	GH1	2.09	2.1	SSUN3F1NEB	2.5P	2.205	-	0.354	0.669	1.28	0.141	0.11	0.187	2	005	○
	GH2	2.09	2.1	SSUN3F2NEB	2.5P	2.205	-	0.354	0.669	1.28	0.141	0.11	0.187	2	005	○
No.4-40UNC	GH1	2.3	2.33	SSUN4H1NEB	2.5P	2.205	-	0.354	0.709	1.28	0.141	0.11	0.187	2	005	○
	GH2	2.3	2.33	SSUN4H2NEB	2.5P	2.205	-	0.354	0.709	1.28	0.141	0.11	0.187	2	005	○
No.5-40UNC	GH1	2.6	2.64	SSUN5H1NEB	2.5P	2.205	-	0.433	0.768	1.358	0.141	0.11	0.187	2	005	○
	GH2	2.6	2.64	SSUN5H2NEB	2.5P	2.205	-	0.433	0.768	1.358	0.141	0.11	0.187	2	005	○
No.6-32UNC	GH1	2.8	2.83	SSUN6J1NEB	2.5P	2.205	-	0.433	0.768	1.358	0.141	0.11	0.187	3	005	○
	GH2	2.8	2.83	SSUN6J2NEB	2.5P	2.205	-	0.433	0.768	1.358	0.141	0.11	0.187	3	005	○
	GH3	2.8	2.83	SSUN6J3NEB	2.5P	2.205	-	0.433	0.768	1.358	0.141	0.11	0.187	3	005	○
	GH4	2.8	2.83	SSUN6J4NEB	2.5P	2.205	-	0.433	0.768	1.358	0.141	0.11	0.187	3	005	○
No.8-32UNC	GH2	3.4	3.47	SSUN8J2NEB	2.5P	2.48	-	0.512	0.827	1.535	0.168	0.131	0.25	3	005	○
	GH3	3.4	3.47	SSUN8J3NEB	2.5P	2.48	-	0.512	0.827	1.535	0.168	0.131	0.25	3	005	○
No.10-24UNC	GH2	3.89	3.9	SSUNAM2NEB	2.5P	2.756	-	0.551	0.984	1.654	0.194	0.152	0.25	3	005	○
	GH3	3.89	3.9	SSUNAM3NEB	2.5P	2.756	-	0.551	0.984	1.654	0.194	0.152	0.25	3	005	○
No.12-24UNC	GH2	4.5	4.53	SSUNCM2NEB	2.5P	3.15	-	0.591	0.984	1.929	0.22	0.165	0.281	3	005	○
	GH3	4.5	4.53	SSUNCM3NEB	2.5P	3.15	-	0.591	0.984	1.929	0.22	0.165	0.281	3	005	○
1/4-20UNC	GH2	5.1	5.19	SSU04N2NEB	2.5P	3.15	-	0.591	1.181	1.713	0.255	0.191	0.312	3	005	○
	GH3	5.1	5.19	SSU04N3NEB	2.5P	3.15	-	0.591	1.181	1.713	0.255	0.191	0.312	3	005	○
	GH5	5.1	5.19	SSU04N5NEB	2.5P	3.15	-	0.591	1.181	1.713	0.255	0.191	0.312	3	005	○
	GH11	5.1	5.19	SSU04N-EEB	2.5P	3.15	-	0.591	1.181	1.713	0.255	0.191	0.312	3	005	○
5/16-18UNC	GH2	6.6	6.65	SSU0502NEB	2.5P	3.543	-	0.748	1.378	1.831	0.318	0.238	0.375	3	006	○
	GH3	6.6	6.65	SSU0503NEB	2.5P	3.543	-	0.748	1.378	1.831	0.318	0.238	0.375	3	006	○
	GH5	6.6	6.65	SSU0505NEB	2.5P	3.543	-	0.748	1.378	1.831	0.318	0.238	0.375	3	006	○
	GH11	6.6	6.65	SSU050-EEB	2.5P	3.543	-	0.748	1.378	1.831	0.318	0.238	0.375	3	006	○
3/8-16UNC	GH3	8	8.07	SSU06P3NEB	2.5P	3.937	-	0.906	1.535	2.028	0.381	0.286	0.437	3	006	○
	GH4	8	8.07	SSU06P4NEB	2.5P	3.937	-	0.906	1.535	2.028	0.381	0.286	0.437	3	006	○
	GH5	8	8.07	SSU06P5NEB	2.5P	3.937	-	0.906	1.535	2.028	0.381	0.286	0.437	3	006	○
	GH11	8	8.07	SSU06P-EEB	2.5P	3.937	-	0.906	1.535	2.028	0.381	0.286	0.437	3	006	○
7/16-14UNC	GH3	9.4	9.45	SSU07Q3NEB	2.5P	3.937	-	0.906	-	2.008	0.323	0.242	0.406	3	007	○
	GH4	9.4	9.45	SSU07Q4NEB	2.5P	3.937	-	0.906	-	2.008	0.323	0.242	0.406	3	007	○
	GH5	9.4	9.45	SSU07Q5NEB	2.5P	3.937	-	0.906	-	2.008	0.323	0.242	0.406	3	007	○
1/2-13UNC	GH3	10.9	10.91	SSU08R3NEB	2.5P	4.331	-	1.024	-	2.205	0.367	0.275	0.437	3	007	○
	GH4	10.9	10.91	SSU08R4NEB	2.5P	4.331	-	1.024	-	2.205	0.367	0.275	0.437	3	007	○
	GH5	10.9	10.91	SSU08R5NEB	2.5P	4.331	-	1.024	-	2.205	0.367	0.275	0.437	3	007	○
	GH11	10.9	10.91	SSU08R-EEB	2.5P	4.331	-	1.024	-	2.205	0.367	0.275	0.437	3	007	○
9/16-12UNC	GH3	12.2	12.33	SSU09S3NEB	2.5P	4.331	-	1.024	-	2.205	0.429	0.322	0.5	3	007	○
	GH4	12.2	12.33	SSU09S4NEB	2.5P	4.331	-	1.024	-	2.205	0.429	0.322	0.5	3	007	○
	GH5	12.2	12.33	SSU09S5NEB	2.5P	4.331	-	1.024	-	2.205	0.429	0.322	0.5	3	007	○
5/8-11UNC	GH3	13.6	13.75	SSU10U3NEB	2.5P	4.331	-	1.024	-	2.205	0.48	0.36	0.562	3	007	○
	GH4	13.6	13.75	SSU10U4NEB	2.5P	4.331	-	1.024	-	2.205	0.48	0.36	0.562	3	007	○
	GH5	13.6	13.75	SSU10U5NEB	2.5P	4.331	-	1.024	-	2.205	0.48	0.36	0.562	3	007	○
	GH11	13.6	13.75	SSU10U-EEB	2.5P	4.331	-	1.024	-	2.205	0.48	0.36	0.562	3	007	○
3/4-10UNC	GH3	16.6	16.7	SSU12V3NEB	2.5P	4.921	-	1.299	-	2.52	0.59	0.442	0.687	4	007	○
	GH5	16.6	16.7	SSU12V5NEB	2.5P	4.921	-	1.299	-	2.52	0.59	0.442	0.687	4	007	○
	GH11	16.6	16.7	SSU12V-EEB	2.5P	4.921	-	1.299	-	2.52	0.59	0.442	0.687	4	007	○

The most suitable GH tap class to cut accurate 2B, 3B (UNJ) and 2B oversized internal threads tolerance, depends on application conditions and work-piece materials. Yamawa GH class system offers a wide range of alternative tap classes allowing each customer to select the most suitable one according to application requirement. Check page 673 of Technical info for full details.

Spiral Fluted Taps

Intro

SP

ANSI

SL

PO

ST

ROLL

CARBIDE

LONG

HAND TAPS

EG (STI)

SPECIAL THREADS, GAUGES

THREAD MILLS

DIES

CENTER DRILLS

Technical info

UNC	TCTR (tolerance)	\varnothing (mm)	Hole \varnothing (mm)	Code	THCHT (chamfer)	LF (inch)	LT (inch)	THL (inch)	LU (inch)	LS (inch)	DCON (inch)	K (inch)	LK (inch)	NOF	Type	Stock
ANSI																
7/8-9UNC	GH4	19.6	19.61	SSU14W4NEB	2.5P	5.512	-	1.299	-	2.795	0.697	0.523	0.75	4	007	○
	GH5	19.6	19.61	SSU14W5NEB	2.5P	5.512	-	1.299	-	2.795	0.697	0.523	0.75	4	007	○
	GH6	19.6	19.61	SSU14W6NEB	2.5P	5.512	-	1.299	-	2.795	0.697	0.523	0.75	4	007	○
1-8UNC	GH4	22.3	22.45	SSU16X4NEB	2.5P	6.299	-	1.457	-	3.228	0.8	0.6	0.812	4	007	○
	GH5	22.3	22.45	SSU16X5NEB	2.5P	6.299	-	1.457	-	3.228	0.8	0.6	0.812	4	007	○
	GH6	22.3	22.45	SSU16X6NEB	2.5P	6.299	-	1.457	-	3.228	0.8	0.6	0.812	4	007	○
1 1/8-7UNC	GH4	25	25.17	SSU18Y4NEB	2.5P	7.087	-	1.732	-	3.622	0.896	0.672	0.875	4	007	○
	GH6	25	25.17	SSU18Y6NEB	2.5P	7.087	-	1.732	-	3.622	0.896	0.672	0.875	4	007	○
1 1/4-7UNC	GH4	28.2	28.35	SSU20Y4NEB	2.5P	7.087	-	1.929	-	3.622	1.021	0.766	1	4	007	○
	GH6	28.2	28.35	SSU20Y6NEB	2.5P	7.087	-	1.929	-	3.622	1.021	0.766	1	4	007	○
1 3/8-6UNC	GH5	30.8	30.92	SSU22Z5NEB	2.5P	7.874	-	2.165	-	4.016	1.108	0.831	1.062	4	007	○
	GH6	30.8	30.92	SSU22Z6NEB	2.5P	7.874	-	2.165	-	4.016	1.108	0.831	1.062	4	007	○
1 1/2-6UNC	GH5	34	34.1	SSU24Z5NEB	2.5P	7.874	-	2.323	-	4.016	1.233	0.925	1.125	4	007	○
	GH6	34	34.1	SSU24Z6NEB	2.5P	7.874	-	2.323	-	4.016	1.233	0.925	1.125	4	007	○
UNF																
ANSI																
No.2-64UNF	GH1	1.85	1.87	SSUN2D1NEB	2.5P	1.772	-	0.314	-	1.161	0.141	0.11	0.187	2	004	○
	GH2	1.85	1.87	SSUN2D2NEB	2.5P	1.772	-	0.314	-	1.161	0.141	0.11	0.187	2	004	○
No.3-56UNF	GH1	2.1	2.15	SSUN3E1NEB	2.5P	2.205	-	0.354	0.669	1.28	0.141	0.11	0.187	2	005	○
	GH2	2.1	2.15	SSUN3E2NEB	2.5P	2.205	-	0.354	0.669	1.28	0.141	0.11	0.187	2	005	○
No.4-48UNF	GH1	2.4	2.41	SSUN4F1NEB	2.5P	2.205	-	0.354	0.709	1.28	0.141	0.11	0.187	2	005	○
	GH2	2.4	2.41	SSUN4F2NEB	2.5P	2.205	-	0.354	0.709	1.28	0.141	0.11	0.187	2	005	○
No.5-44UNF	GH1	2.7	2.69	SSUN5G1NEB	2.5P	2.205	-	0.433	0.768	1.358	0.141	0.11	0.187	2	005	○
	GH2	2.7	2.69	SSUN5G2NEB	2.5P	2.205	-	0.433	0.768	1.358	0.141	0.11	0.187	2	005	○
No.6-40UNF	GH1	2.9	2.97	SSUN6H1NEB	2.5P	2.205	-	0.433	0.768	1.358	0.141	0.11	0.187	3	005	○
	GH2	2.9	2.97	SSUN6H2NEB	2.5P	2.205	-	0.433	0.768	1.358	0.141	0.11	0.187	3	005	○
No.8-36UNF	GH2	3.5	3.55	SSUN8I2NEB	2.5P	2.48	-	0.512	0.827	1.535	0.168	0.131	0.25	3	005	○
	GH3	3.5	3.55	SSUN8I3NEB	2.5P	2.48	-	0.512	0.827	1.535	0.168	0.131	0.25	3	005	○
No.10-32UNF	GH2	4.1	4.12	SSUNAJ2NEB	2.5P	2.756	-	0.551	0.984	1.654	0.194	0.152	0.25	3	005	○
	GH3	4.1	4.12	SSUNAJ3NEB	2.5P	2.756	-	0.551	0.984	1.654	0.194	0.152	0.25	3	005	○
No.12-28UNF	GH2	4.6	4.67	SSUNCK2NEB	2.5P	3.15	-	0.591	0.984	1.929	0.22	0.165	0.281	3	005	○
	GH3	4.6	4.67	SSUNCK3NEB	2.5P	3.15	-	0.591	0.984	1.929	0.22	0.165	0.281	3	005	○
1/4-28UNF	GH2	5.5	5.53	SSU04K2NEB	2.5P	3.15	-	0.591	1.181	1.713	0.255	0.191	0.312	3	005	○
	GH3	5.5	5.53	SSU04K3NEB	2.5P	3.15	-	0.591	1.181	1.713	0.255	0.191	0.312	3	005	○
	GH4	5.5	5.53	SSU04K4NEB	2.5P	3.15	-	0.591	1.181	1.713	0.255	0.191	0.312	3	005	○
	GH11	5.5	5.53	SSU04K-EEB	2.5P	3.15	-	0.591	1.181	1.713	0.255	0.191	0.312	3	005	○
5/16-24UNF	GH2	6.9	6.97	SSU05M2NEB	2.5P	3.543	-	0.748	1.378	1.831	0.318	0.238	0.375	3	006	○
	GH3	6.9	6.97	SSU05M3NEB	2.5P	3.543	-	0.748	1.378	1.831	0.318	0.238	0.375	3	006	○
	GH4	6.9	6.97	SSU05M4NEB	2.5P	3.543	-	0.748	1.378	1.831	0.318	0.238	0.375	3	006	○
	GH5	6.9	6.97	SSU05M5NEB	2.5P	3.543	-	0.748	1.378	1.831	0.318	0.238	0.375	3	006	○
	GH11	6.9	6.97	SSU05M-EEB	2.5P	3.543	-	0.748	1.378	1.831	0.318	0.238	0.375	3	006	○
3/8-24UNF	GH2	8.5	8.57	SSU06M2NEB	2.5P	3.937	-	0.906	1.535	2.028	0.381	0.286	0.437	3	006	○
	GH3	8.5	8.57	SSU06M3NEB	2.5P	3.937	-	0.906	1.535	2.028	0.381	0.286	0.437	3	006	○
	GH4	8.5	8.57	SSU06M4NEB	2.5P	3.937	-	0.906	1.535	2.028	0.381	0.286	0.437	3	006	○
	GH11	8.5	8.57	SSU06M-EEB	2.5P	3.937	-	0.906	1.535	2.028	0.381	0.286	0.437	3	006	○

UNF	TCTR (tolerance)	 Hole Ø (mm)	Hole Ø (mm)	Code	THCHT (chamfer)	LF (inch)	LT (inch)	THL (inch)	LU (inch)	LS (inch)	DCON (inch)	K (inch)	LK (inch)	NOF	Type	Stock
ANSI																
7/16-20UNF	GH2	9.9	9.96	SSU07N2NEB	2.5P	3.937	-	0.906	-	2.008	0.323	0.242	0.406	3	007	○
	GH3	9.9	9.96	SSU07N3NEB	2.5P	3.937	-	0.906	-	2.008	0.323	0.242	0.406	3	007	○
	GH5	9.9	9.96	SSU07N5NEB	2.5P	3.937	-	0.906	-	2.008	0.323	0.242	0.406	3	007	○
1/2-20UNF	GH2	11.5	11.54	SSU08N2NEB	2.5P	4.331	-	1.024	-	2.205	0.367	0.275	0.437	3	007	○
	GH3	11.5	11.54	SSU08N3NEB	2.5P	4.331	-	1.024	-	2.205	0.367	0.275	0.437	3	007	○
	GH5	11.5	11.54	SSU08N5NEB	2.5P	4.331	-	1.024	-	2.205	0.367	0.275	0.437	3	007	○
	GH11	11.5	11.54	SSU08N-EEB	2.5P	4.331	-	1.024	-	2.205	0.367	0.275	0.437	3	007	○
9/16-18UNF	GH3	12.9	13	SSU09O3NEB	2.5P	4.331	-	1.024	-	2.205	0.429	0.322	0.5	3	007	○
	GH4	12.9	13	SSU09O4NEB	2.5P	4.331	-	1.024	-	2.205	0.429	0.322	0.5	3	007	○
	GH5	12.9	13	SSU09O5NEB	2.5P	4.331	-	1.024	-	2.205	0.429	0.322	0.5	3	007	○
5/8-18UNF	GH3	14.5	14.6	SSU10O3NEB	2.5P	4.331	-	1.024	-	2.205	0.48	0.36	0.562	3	007	○
	GH4	14.5	14.6	SSU10O4NEB	2.5P	4.331	-	1.024	-	2.205	0.48	0.36	0.562	3	007	○
	GH5	14.5	14.6	SSU10O5NEB	2.5P	4.331	-	1.024	-	2.205	0.48	0.36	0.562	3	007	○
	GH11	14.5	14.6	SSU10O-EEB	2.5P	4.331	-	1.024	-	2.205	0.48	0.36	0.562	3	007	○
3/4-16UNF	GH3	17.5	17.59	SSU12P3NEB	2.5P	4.921	-	1.299	-	2.52	0.59	0.442	0.687	4	007	○
	GH4	17.5	17.59	SSU12P4NEB	2.5P	4.921	-	1.299	-	2.52	0.59	0.442	0.687	4	007	○
	GH5	17.5	17.59	SSU12P5NEB	2.5P	4.921	-	1.299	-	2.52	0.59	0.442	0.687	4	007	○
	GH11	17.5	17.59	SSU12P-EEB	2.5P	4.921	-	1.299	-	2.52	0.59	0.442	0.687	4	007	○
7/8-14UNF	GH3	20.5	20.57	SSU14O3NEB	2.5P	5.512	-	1.299	-	2.795	0.697	0.523	0.75	4	007	○
	GH4	20.5	20.57	SSU14O4NEB	2.5P	5.512	-	1.299	-	2.795	0.697	0.523	0.75	4	007	○
	GH6	20.5	20.57	SSU14O6NEB	2.5P	5.512	-	1.299	-	2.795	0.697	0.523	0.75	4	007	○
1-12UNF	GH3	23.3	23.46	SSU16S3NEB	2.5P	6.299	-	1.457	-	3.228	0.8	0.6	0.812	4	007	○
	GH4	23.3	23.46	SSU16S4NEB	2.5P	6.299	-	1.457	-	3.228	0.8	0.6	0.812	4	007	○
	GH5	23.3	23.46	SSU16S5NEB	2.5P	6.299	-	1.457	-	3.228	0.8	0.6	0.812	4	007	○
	GH6	23.3	23.46	SSU16S6NEB	2.5P	6.299	-	1.457	-	3.228	0.8	0.6	0.812	4	007	○
1 1/8-12UNF	GH4	26.5	26.63	SSU18S4NEB	2.5P	7.087	-	1.732	-	3.622	0.896	0.672	0.875	4	007	○
	GH5	26.5	26.63	SSU18S5NEB	2.5P	7.087	-	1.732	-	3.622	0.896	0.672	0.875	4	007	○
1 1/4-12UNF	GH4	29.6	29.81	SSU20S4NEB	2.5P	7.087	-	1.929	-	3.622	1.021	0.766	1	4	007	○
	GH5	29.6	29.81	SSU20S5NEB	2.5P	7.087	-	1.929	-	3.622	1.021	0.766	1	4	007	○
1 3/8-12UNF	GH4	32.8	32.98	SSU22S4NEB	2.5P	7.874	-	2.165	-	4.016	1.108	0.831	1.062	4	007	○
	GH5	32.8	32.98	SSU22S5NEB	2.5P	7.874	-	2.165	-	4.016	1.108	0.831	1.062	4	007	○
1 1/2-12UNF	GH4	36	36.16	SSU24S4NEB	2.5P	7.874	-	2.323	-	4.016	1.233	0.925	1.125	4	007	○
	GH5	36	36.16	SSU24S5NEB	2.5P	7.874	-	2.323	-	4.016	1.233	0.925	1.125	4	007	○

Intro

SP

ANSI

SL

PO

ST

ROLL

CARBIDE

LONG

HAND TAPS

EG (STI)

SPECIAL THREADS, GAUGES

THREAD MILLS

DIES

CENTER DRILLS

Technical info

The most suitable GH tap class to cut accurate 2B, 3B (UNJ) and 2B oversized internal threads tolerance, depends on application conditions and work-piece materials. Yamawa GH class system offers a wide range of alternative tap classes allowing each customer to select the most suitable one according to application requirement. Check page 673 of Technical info for full details.

Intro

ZELX SS SP



SP

MS Material Specific Series

Spiral Fluted Taps for Stainless Steel

ANSI



FEATURES

Material specific for blind hole application.
Most suitable for stainless steel, steel and alloy steel.
OX treatment reduces welding troubles.

SL

PO

Recommended Tapping Speeds Depending On Materials

ISO	Vc (m/min)	★	ISO	Vc (m/min)	★
P2	≤10	★	M1	≤10	★
P3	≤10	★			
P4	≤10	☆			
P7	≤10	★			

★ 1st choice ☆ suitable

ST

ROLL

CARBIDE

LONG

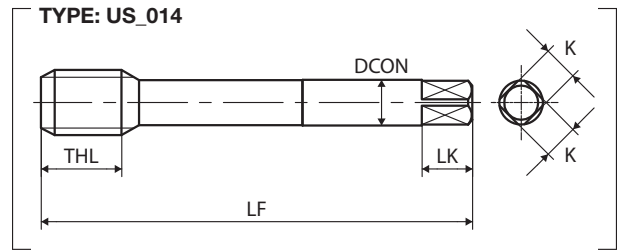
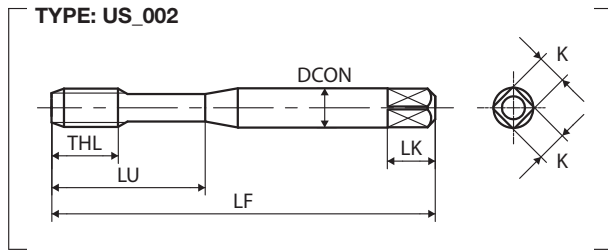

HAND TAPS

UNC	TCTR (tolerance)	∅ (mm)	Hole ∅ (mm)	Code	THCHT (chamfer)	LF (inch)	LT (inch)	THL (inch)	LU (inch)	LS (inch)	DCON (inch)	K (inch)	LK (inch)	NOF	Type	Stock
ANSI																
No.2-56UNC	GH2	1.8	1.83	Y84623	2.5P	1.75	-	0.157	0.437	-	0.141	0.11	0.187	2	002	○
	GH2	2.09	2.1	Y84600	2.5P	1.812	-	0.197	0.5	-	0.141	0.11	0.187	2	002	○
No.4-40UNC	GH2	2.3	2.33	Y84601	2.5P	1.875	-	0.236	0.562	-	0.141	0.11	0.187	2	002	○
	GH2	2.3	2.33	Y84001	1.5P	1.875	-	0.236	0.562	-	0.141	0.11	0.187	2	002	○
	GH3	2.3	2.33	Y84602	2.5P	1.875	-	0.236	0.562	-	0.141	0.11	0.187	2	002	○
	GH3	2.3	2.33	Y84002	1.5P	1.875	-	0.236	0.562	-	0.141	0.11	0.187	2	002	○
	GH4	2.3	2.33	Y84629	2.5P	1.875	-	0.236	0.562	-	0.141	0.11	0.187	2	002	○
	GH5	2.3	2.33	Y84634	2.5P	1.875	-	0.236	0.562	-	0.141	0.11	0.187	2	002	○
No.5-40UNC	GH5	2.3	2.33	Y84034	1.5P	1.875	-	0.236	0.562	-	0.141	0.11	0.187	2	002	○
	GH2	2.6	2.64	Y84603	2.5P	1.937	-	0.236	0.625	-	0.141	0.11	0.187	3	002	○
	GH2	2.6	2.64	Y84003	1.5P	1.937	-	0.236	0.625	-	0.141	0.11	0.187	3	002	○

THREAD MILLS

DIES

CENTER DRILLS

Technical info

UNC	TCTR (tolerance)	∅ (mm)	Hole ∅ (mm)	Code	THCHT (chamfer)	LF (inch)	LT (inch)	THL (inch)	LU (inch)	LS (inch)	DCON (inch)	K (inch)	LK (inch)	NOF	Type	Stock
ANSI																
No.6-32UNC	GH2	2.8	2.83	Y84604	2.5P	2	-	0.276	0.687	-	0.141	0.11	0.187	3	002	○
	GH2	2.8	2.83	Y84004	1.5P	2	-	0.276	0.687	-	0.141	0.11	0.187	3	002	○
	GH3	2.8	2.83	Y84605	2.5P	2	-	0.276	0.687	-	0.141	0.11	0.187	3	002	○
	GH3	2.8	2.83	Y84005	1.5P	2	-	0.276	0.687	-	0.141	0.11	0.187	3	002	○
	GH4	2.8	2.83	Y84636	2.5P	2	-	0.276	0.687	-	0.141	0.11	0.187	3	002	○
	GH5	2.8	2.83	Y84635	2.5P	2	-	0.276	0.687	-	0.141	0.11	0.187	3	002	○
	GH6	2.8	2.83	Y84659	2.5P	2	-	0.276	0.687	-	0.141	0.11	0.187	3	002	○
	GH7	2.8	2.83	Y84665	2.5P	2	-	0.276	0.687	-	0.141	0.11	0.187	3	002	○
No.8-32UNC	GH5	2.8	2.83	Y84035	2.5P	2	-	0.276	0.687	-	0.141	0.11	0.187	3	002	○
	GH2	3.4	3.47	Y84606	2.5P	2.125	-	0.276	0.75	-	0.168	0.131	0.25	3	002	○
	GH3	3.4	3.47	Y84607	2.5P	2.125	-	0.276	0.75	-	0.168	0.131	0.25	3	002	○
	GH3	3.4	3.47	Y84007	1.5P	2.125	-	0.276	0.75	-	0.168	0.131	0.25	3	002	○
	GH4	3.4	3.47	Y84638	2.5P	2.125	-	0.276	0.75	-	0.168	0.131	0.25	3	002	○
	GH5	3.4	3.47	Y84637	2.5P	2.125	-	0.276	0.75	-	0.168	0.131	0.25	3	002	○
	GH6	3.4	3.47	Y84660	2.5P	2.125	-	0.276	0.75	-	0.168	0.131	0.25	3	002	○
	GH7	3.4	3.47	Y84667	2.5P	2.125	-	0.276	0.75	-	0.168	0.131	0.25	3	002	○
No.10-24UNC	GH2	3.4	3.47	Y84006	1.5P	2.125	-	0.276	0.75	-	0.168	0.131	0.25	3	002	○
	GH5	3.4	3.47	Y84037	1.5P	2.125	-	0.276	0.75	-	0.168	0.131	0.25	3	002	○
	GH2	3.89	3.9	Y84624	2.5P	2.375	-	0.354	0.875	-	0.194	0.152	0.25	3	002	○
	GH3	3.89	3.9	Y84609	2.5P	2.375	-	0.354	0.875	-	0.194	0.152	0.25	3	002	○
	GH3	3.89	3.9	Y84009	1.5P	2.375	-	0.354	0.875	-	0.194	0.152	0.25	3	002	○
	GH5	3.89	3.9	Y84639	2.5P	2.375	-	0.354	0.875	-	0.194	0.152	0.25	3	002	○
	GH5	3.89	3.9	Y84039	1.5P	2.375	-	0.354	0.875	-	0.194	0.152	0.25	3	002	○
	GH6	3.89	3.9	Y84690	2.5P	2.375	-	0.354	0.875	-	0.194	0.152	0.25	3	002	○
No.12-24UNC	GH7	3.89	3.9	Y84669	2.5P	2.375	-	0.354	0.875	-	0.194	0.152	0.25	3	002	○
	GH3	4.5	4.53	Y84688	2.5P	2.375	-	0.354	0.937	-	0.22	0.165	0.281	3	002	○
1/4-20UNC	GH3	5.1	5.19	Y84613	2.5P	2.5	-	0.433	1	-	0.255	0.191	0.312	3	002	○
	GH3	5.1	5.19	Y84013	1.5P	2.5	-	0.433	1	-	0.255	0.191	0.312	3	002	○
	GH5	5.1	5.19	Y84643	2.5P	2.5	-	0.433	1	-	0.255	0.191	0.312	3	002	○
	GH5	5.1	5.19	Y84043	1.5P	2.5	-	0.433	1	-	0.255	0.191	0.312	3	002	○
	GH7	5.1	5.19	Y84673	2.5P	2.5	-	0.433	1	-	0.255	0.191	0.312	3	002	○
5/16-18UNC	GH3	6.6	6.65	Y84615	2.5P	2.718	-	0.472	1.125	-	0.318	0.238	0.375	3	002	○
	GH3	6.6	6.65	Y84015	1.5P	2.718	-	0.472	1.125	-	0.318	0.238	0.375	3	002	○
	GH5	6.6	6.65	Y84645	2.5P	2.718	-	0.472	1.125	-	0.318	0.238	0.375	3	002	○
	GH5	6.6	6.65	Y84045	1.5P	2.718	-	0.472	1.125	-	0.318	0.238	0.375	3	002	○
	GH7	6.6	6.65	Y84675	2.5P	2.718	-	0.472	1.125	-	0.318	0.238	0.375	3	002	○
3/8-16UNC	GH3	8	8.07	Y84617	2.5P	2.937	-	0.551	1.25	-	0.381	0.286	0.437	3	002	○
	GH3	8	8.07	Y84017	1.5P	2.937	-	0.551	1.25	-	0.381	0.286	0.437	3	002	○
	GH5	8	8.07	Y84647	2.5P	2.937	-	0.551	1.25	-	0.381	0.286	0.437	3	002	○
	GH5	8	8.07	Y84047	1.5P	2.937	-	0.551	1.25	-	0.381	0.286	0.437	3	002	○
	GH7	8	8.07	Y84677	2.5P	2.937	-	0.551	1.25	-	0.381	0.286	0.437	3	002	○
	GH7	8	8.07	Y84077	1.5P	2.937	-	0.551	1.25	-	0.381	0.286	0.437	3	002	○
7/16-14UNC	GH3	9.4	9.45	Y84619	2.5P	3.156	-	0.591	-	-	0.323	0.242	0.406	3	014	○
	GH3	9.4	9.45	Y84019	1.5P	3.156	-	0.591	-	-	0.323	0.242	0.406	3	014	○
	GH5	9.4	9.45	Y84649	2.5P	3.156	-	0.591	-	-	0.323	0.242	0.406	3	014	○
	GH5	9.4	9.45	Y84049	1.5P	3.156	-	0.591	-	-	0.323	0.242	0.406	3	014	○
	GH7	9.4	9.45	Y84679	2.5P	3.156	-	0.591	-	-	0.323	0.242	0.406	3	014	○

Intro

SP
ANSI

SL

PO

ST

ROLL

CARBIDE

LONG

HAND
TAPS

EG (STI)

SPECIAL
THREADS,
GAUGES

THREAD
MILLS

DIES

CENTER
DRILLS

Technical
info

Spiral Fluted Taps

Intro

SP

ANSI

SL

PO

ST

ROLL

CARBIDE

LONG

HAND
TAPS

EG (STI)

SPECIAL
THREADS,
GAUGES

THREAD
MILLS

DIES

CENTER
DRILLS

Technical
info

UNC	TCTR (tolerance)	\varnothing (mm)	Hole \varnothing (mm)	Code	THCHT (chamfer)	LF (inch)	LT (inch)	THL (inch)	LU (inch)	LS (inch)	DCON (inch)	K (inch)	LK (inch)	NOF	Type	Stock
ANSI																
1/2-13UNC	GH3	10.9	10.91	Y84621	2.5P	3.375	-	0.63	-	-	0.367	0.275	0.437	3	014	○
	GH3	10.9	10.91	Y84021	1.5P	3.375	-	0.63	-	-	0.367	0.275	0.437	3	014	○
	GH5	10.9	10.91	Y84651	2.5P	3.375	-	0.63	-	-	0.367	0.275	0.437	3	014	○
	GH5	10.9	10.91	Y84051	1.5P	3.375	-	0.63	-	-	0.367	0.275	0.437	3	014	○
	GH7	10.9	10.91	Y84681	2.5P	3.375	-	0.63	-	-	0.367	0.275	0.437	3	014	○
9/16-12UNC	GH3	12.2	12.33	Y84653	2.5P	3.593	-	0.709	-	-	0.429	0.322	0.5	3	014	○
	GH3	12.2	12.33	Y84053	1.5P	3.593	-	0.709	-	-	0.429	0.322	0.5	3	014	○
5/8-11UNC	GH3	13.6	13.75	Y84625	2.5P	3.812	-	0.748	-	-	0.48	0.36	0.562	3	014	○
	GH3	13.6	13.75	Y84025	1.5P	3.812	-	0.748	-	-	0.48	0.36	0.562	3	014	○
	GH5	13.6	13.75	Y84655	2.5P	3.812	-	0.748	-	-	0.48	0.36	0.562	3	014	○
	GH5	13.6	13.75	Y84055	1.5P	3.812	-	0.748	-	-	0.48	0.36	0.562	3	014	○
3/4-10UNC	GH3	16.6	16.7	Y84627	2.5P	4.25	-	0.827	-	-	0.59	0.442	0.687	4	014	○
	GH3	16.6	16.7	Y84027	1.5P	4.25	-	0.827	-	-	0.59	0.442	0.687	4	014	○
	GH5	16.6	16.7	Y84657	2.5P	4.25	-	0.827	-	-	0.59	0.442	0.687	4	014	○
7/8-9UNC	GH4	19.6	19.61	Y84695	2.5P	4.687	-	0.827	-	-	0.697	0.523	0.75	4	014	○
1-8UNC	GH4	22.3	22.45	Y84697	2.5P	5.125	-	0.984	-	-	0.8	0.6	0.812	4	014	○
1 1/8-7UNC	GH6	25	25.17	Y84701	2.5P	5.437	-	1.181	-	-	0.896	0.672	0.875	4	014	○
1 1/4-7UNC	GH6	28.2	28.35	Y84703	2.5P	5.75	-	1.181	-	-	1.021	0.766	1	4	014	○
1 3/8-6UNC	GH6	30.8	30.92	Y84706	2.5P	6.062	-	1.575	-	-	1.108	0.831	1.062	4	014	○
1 1/2-6UNC	GH6	34	34.1	Y84709	2.5P	6.375	-	1.575	-	-	1.233	0.925	1.125	4	014	○
1 3/4-5UNC	GH7	39.5	39.61	Y84714	2.5P	7	-	1.772	-	-	1.43	1.072	1.25	4	014	○
2-4.5UNC	GH7	45.2	45.37	Y84715	2.5P	7.625	-	1.969	-	-	1.644	1.233	1.375	4	014	○
UNF	TCTR (tolerance)	\varnothing (mm)	Hole \varnothing (mm)	Code	THCHT (chamfer)	LF (inch)	LT (inch)	THL (inch)	LU (inch)	LS (inch)	DCON (inch)	K (inch)	LK (inch)	NOF	Type	Stock
ANSI																
No.4-48UNF	GH2	2.4	2.41	Y84683	2.5P	1.875	-	0.236	0.562	-	0.141	0.11	0.187	2	002	○
	GH2	2.4	2.41	Y84083	1.5P	1.875	-	0.236	0.562	-	0.141	0.11	0.187	2	002	○
No.6-40UNF	GH2	2.9	2.97	Y84684	2.5P	2	-	0.276	0.687	-	0.141	0.11	0.187	3	002	○
	GH2	2.9	2.97	Y84084	1.5P	2	-	0.276	0.687	-	0.141	0.11	0.187	3	002	○
No.8-36UNF	GH3	2.9	2.97	Y84685	2.5P	2	-	0.276	0.687	-	0.141	0.11	0.187	3	002	○
	GH3	2.9	2.97	Y84085	1.5P	2	-	0.276	0.687	-	0.141	0.11	0.187	3	002	○
No.10-32UNF	GH3	3.5	3.55	Y84687	2.5P	2.125	-	0.276	0.75	-	0.168	0.131	0.25	3	002	○
	GH2	4.1	4.12	Y84611	2.5P	2.375	-	0.276	0.875	-	0.194	0.152	0.25	3	002	○
	GH3	4.1	4.12	Y84610	2.5P	2.375	-	0.276	0.875	-	0.194	0.152	0.25	3	002	○
	GH3	4.1	4.12	Y84010	1.5P	2.375	-	0.276	0.875	-	0.194	0.152	0.25	3	002	○
	GH4	4.1	4.12	Y84630	2.5P	2.375	-	0.276	0.875	-	0.194	0.152	0.25	3	002	○
	GH5	4.1	4.12	Y84640	2.5P	2.375	-	0.276	0.875	-	0.194	0.152	0.25	3	002	○
	GH5	4.1	4.12	Y84040	1.5P	2.375	-	0.276	0.875	-	0.194	0.152	0.25	3	002	○
No.12-28UNF	GH6	4.1	4.12	Y84662	2.5P	2.375	-	0.276	0.875	-	0.194	0.152	0.25	3	002	○
	GH7	4.1	4.12	Y84670	2.5P	2.375	-	0.276	0.875	-	0.194	0.152	0.25	3	002	○
	GH3	4.6	4.67	Y84689	2.5P	2.375	-	0.276	0.937	-	0.22	0.165	0.281	3	002	○
	GH3	5.5	5.53	Y84614	2.5P	2.5	-	0.354	1	-	0.255	0.191	0.312	3	002	○
	GH3	5.5	5.53	Y84014	1.5P	2.5	-	0.354	1	-	0.255	0.191	0.312	3	002	○
	GH4	5.5	5.53	Y84631	2.5P	2.5	-	0.354	1	-	0.255	0.191	0.312	3	002	○
	GH5	5.5	5.53	Y84644	2.5P	2.5	-	0.354	1	-	0.255	0.191	0.312	3	002	○
1/4-28UNF	GH5	5.5	5.53	Y84044	2.5P	2.5	-	0.354	1	-	0.255	0.191	0.312	3	002	○
	GH6	5.5	5.53	Y84664	2.5P	2.5	-	0.354	1	-	0.255	0.191	0.312	3	002	○
	GH7	5.5	5.53	Y84674	2.5P	2.5	-	0.354	1	-	0.255	0.191	0.312	3	002	○

UNF	TCTR (tolerance)	Ø (mm)	Hole Ø (mm)	Code	THCHT (chamfer)	LF (inch)	LT (inch)	THL (inch)	LU (inch)	LS (inch)	DCON (inch)	K (inch)	LK (inch)	NOF	Type	Stock
ANSI																
5/16-24UNF	GH3	6.9	6.97	Y84616	2.5P	2.718	-	0.394	1.125	-	0.318	0.238	0.375	3	002	○
	GH3	6.9	6.97	Y84016	1.5P	2.718	-	0.394	1.125	-	0.318	0.238	0.375	3	002	○
	GH4	6.9	6.97	Y84632	2.5P	2.718	-	0.394	1.125	-	0.318	0.238	0.375	3	002	○
	GH5	6.9	6.97	Y84646	2.5P	2.718	-	0.394	1.125	-	0.318	0.238	0.375	3	002	○
	GH5	6.9	6.97	Y84046	2.5P	2.718	-	0.394	1.125	-	0.318	0.238	0.375	3	002	○
	GH7	6.9	6.97	Y84676	2.5P	2.718	-	0.394	1.125	-	0.318	0.238	0.375	3	002	○
3/8-24UNF	GH3	8.5	8.57	Y84618	2.5P	2.937	-	0.394	1.25	-	0.381	0.286	0.437	3	002	○
	GH3	8.5	8.57	Y84018	1.5P	2.937	-	0.394	1.25	-	0.381	0.286	0.437	3	002	○
	GH4	8.5	8.57	Y84633	2.5P	2.937	-	0.394	1.25	-	0.381	0.286	0.437	3	002	○
	GH4	8.5	8.57	Y84033	1.5P	2.937	-	0.394	1.25	-	0.381	0.286	0.437	3	002	○
	GH5	8.5	8.57	Y84648	2.5P	2.937	-	0.394	1.25	-	0.381	0.286	0.437	3	002	○
	GH5	8.5	8.57	Y84048	1.5P	2.937	-	0.394	1.25	-	0.381	0.286	0.437	3	002	○
7/16-20UNF	GH3	9.9	9.96	Y84620	2.5P	3.156	-	0.472	-	-	0.323	0.242	0.406	3	014	○
	GH3	9.9	9.96	Y84020	1.5P	3.156	-	0.472	-	-	0.323	0.242	0.406	3	014	○
	GH5	9.9	9.96	Y84650	2.5P	3.156	-	0.472	-	-	0.323	0.242	0.406	3	014	○
	GH5	9.9	9.96	Y84050	1.5P	3.156	-	0.472	-	-	0.323	0.242	0.406	3	014	○
	GH6	9.9	9.96	Y84691	2.5P	3.156	-	0.472	-	-	0.323	0.242	0.406	3	014	○
	GH7	9.9	9.96	Y84680	2.5P	3.156	-	0.472	-	-	0.323	0.242	0.406	3	014	○
1/2-20UNF	GH3	11.5	11.54	Y84622	2.5P	3.375	-	0.472	-	-	0.367	0.275	0.437	3	014	○
	GH3	11.5	11.54	Y84022	1.5P	3.375	-	0.472	-	-	0.367	0.275	0.437	3	014	○
	GH5	11.5	11.54	Y84652	2.5P	3.375	-	0.472	-	-	0.367	0.275	0.437	3	014	○
	GH5	11.5	11.54	Y84052	1.5P	3.375	-	0.472	-	-	0.367	0.275	0.437	3	014	○
	GH6	11.5	11.54	Y84692	2.5P	3.375	-	0.472	-	-	0.367	0.275	0.437	3	014	○
	GH7	11.5	11.54	Y84682	2.5P	3.375	-	0.472	-	-	0.367	0.275	0.437	3	014	○
9/16-18UNF	GH3	12.9	13	Y84654	2.5P	3.593	-	0.512	-	-	0.429	0.322	0.5	3	014	○
	GH3	12.9	13	Y84054	1.5P	3.593	-	0.512	-	-	0.429	0.322	0.5	3	014	○
	GH5	12.9	13	Y84698	2.5P	3.593	-	0.512	-	-	0.429	0.322	0.5	3	014	○
5/8-18UNF	GH3	14.5	14.6	Y84626	2.5P	3.812	-	0.512	-	-	0.48	0.36	0.562	3	014	○
	GH3	14.5	14.6	Y84026	1.5P	3.812	-	0.512	-	-	0.48	0.36	0.562	3	014	○
	GH5	14.5	14.6	Y84656	2.5P	3.812	-	0.512	-	-	0.48	0.36	0.562	3	014	○
	GH5	14.5	14.6	Y84056	1.5P	3.812	-	0.512	-	-	0.48	0.36	0.562	3	014	○
	GH7	14.5	14.6	Y84672	2.5P	3.812	-	0.512	-	-	0.48	0.36	0.562	3	014	○
3/4-16UNF	GH3	17.5	17.59	Y84628	2.5P	4.25	-	0.591	-	-	0.59	0.442	0.687	4	014	○
	GH3	17.5	17.59	Y84028	1.5P	4.25	-	0.591	-	-	0.59	0.442	0.687	4	014	○
	GH5	17.5	17.59	Y84658	2.5P	4.25	-	0.591	-	-	0.59	0.442	0.687	4	014	○
	GH7	17.5	17.59	Y84686	2.5P	4.25	-	0.591	-	-	0.59	0.442	0.687	4	014	○
7/8-14UNF	GH4	20.5	20.57	Y84696	2.5P	4.687	-	0.709	-	-	0.697	0.523	0.75	4	014	○
	GH6	20.5	20.57	Y84694	2.5P	4.687	-	0.709	-	-	0.697	0.523	0.75	4	014	○
1-12UNF	GH4	23.3	23.46	Y84668	2.5P	5.125	-	0.709	-	-	0.8	0.6	0.812	4	014	○
1 1/8-12UNF	GH5	26.5	26.63	Y84702	2.5P	5.437	-	0.787	-	-	0.896	0.672	0.875	4	014	○
1 1/4-12UNF	GH5	29.6	29.81	Y84705	2.5P	5.75	-	0.787	-	-	1.021	0.766	1	4	014	○
1 3/8-12UNF	GH5	32.8	32.98	Y84707	2.5P	6.062	-	0.787	-	-	1.108	0.831	1.062	4	014	○
1 1/2-12UNF	GH5	36	36.16	Y84711	2.5P	6.375	-	0.787	-	-	1.233	0.925	1.125	4	014	○

Intro

SP
ANSI

SL

PO

ST

ROLL

CARBIDE

LONG

HAND
TAPS

EG (STI)

SPECIAL
THREADS,
GAUGES

THREAD
MILLS

DIES

CENTER
DRILLS

Technical
info

Intro

ZELX SS NPT



SP

MS Material Specific Series

Taps for American Taper Pipe Threads, for stainless steel

ANSI



FEATURES

Material specific for blind hole application.
Most suitable for stainless steel, steel and alloy steel.
OX treatment reduces welding troubles.

SL

PO

Recommended Tapping Speeds Depending On Materials

ISO	Vc (m/min)	★	ISO	Vc (m/min)	★
P2	≤5	★	M1	≤5	★
P3	≤5	★	M2	≤5	★
P4	≤5	☆			
P7	≤5	★			

★ 1st choice ☆ suitable

ST

ROLL

CARBIDE

LONG

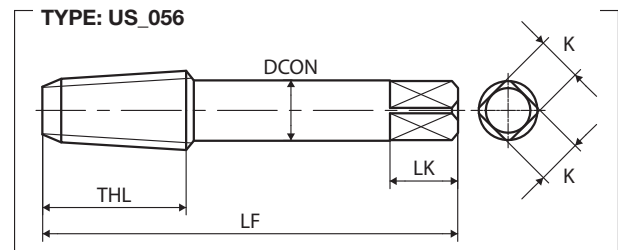
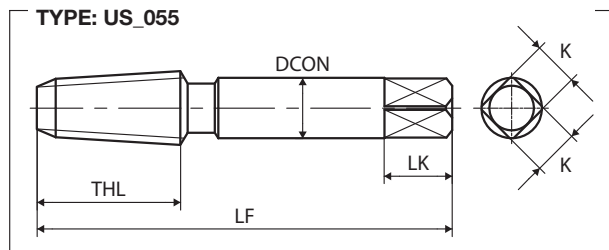

HAND TAPS

NPT	TCTR (tolerance)	Hole Ø (mm)	Hole Ø (mm)	Code	THCHT (chamfer)	Basic major Ø (mm)	LF (inch)	THL (inch)	LS (inch)	DCON (inch)	K (inch)	LK (inch)	NOF	Type	Stock
ANSI															
1/16-27	ANSI G	6	6.05	Y83640	2.5P	7.770	2.125	0.687	-	0.312	0.234	0.375	4	055	○
1/8-27	ANSI G	8.35	8.39	Y83641	2.5P	10.117	2.125	0.75	-	0.437	0.328	0.375	4	055	●
	ANSI G	8.35	8.39	Y83642	2.5P	10.117	2.125	0.75	-	0.312	0.234	0.375	4	056	○
1/4-18	ANSI G	10.8	10.85	Y83643	2.5P	13.426	2.437	1.062	-	0.562	0.421	0.437	4	055	●
3/8-18	ANSI G	14.25	14.27	Y83644	2.5P	16.866	2.562	1.062	-	0.7	0.531	0.5	4	055	●
1/2-14	ANSI G	17.5	17.6	Y83645	2.5P	20.980	3.125	1.375	-	0.687	0.515	0.625	4	056	●
3/4-14	ANSI G	22.9	22.91	Y83646	2.5P	26.325	3.25	1.375	-	0.906	0.679	0.687	4	056	●
1-11 1/2	ANSI G	28.75	28.78	Y83647	2.5P	32.934	3.75	1.75	-	1.125	0.843	0.812	4	056	○

EG (STI)

SPECIAL THREADS, GAUGES

THREAD MILLS

DIES

CENTER DRILLS

Technical info

ZELX SS NPTF

MS Material Specific Series

Taps for American Dryseal Taper Pipe Threads, for stainless steel



FEATURES

Material specific for blind hole application.
Most suitable for stainless steel, steel and alloy steel.
OX treatment reduces welding troubles.

Recommended Tapping Speeds Depending On Materials

ISO	Vc (m/min)	★	ISO	Vc (m/min)	★
P2	≤5	★	M1	≤5	★
P3	≤5	★	M2	≤5	★
P4	≤5	☆			
P7	≤5	★			

★ 1st choice ☆ suitable

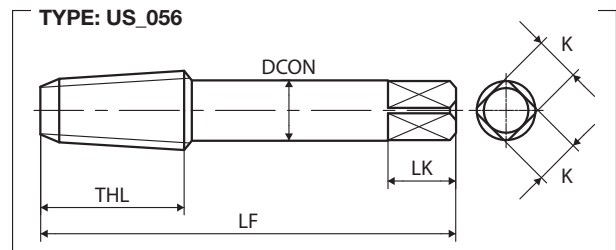
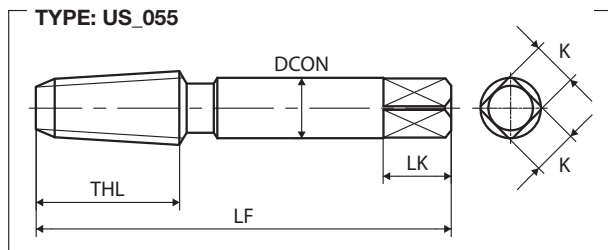

NPTF	TCTR (tolerance)	Hole Ø (mm)	Hole Ø (mm)	Code	THCHT (chamfer)	Basic major Ø (mm)	LF (inch)	THL (inch)	LS (inch)	DCON (inch)	K (inch)	LK (inch)	NOF	Type	Stock
ANSI															
1/16-27	ANSI G	5.95	5.99	Y83660	2.5P	7.770	2.125	0.687	-	0.312	0.234	0.375	4	055	○
1/8-27	ANSI G	8.3	8.34	Y83661	2.5P	10.117	2.125	0.75	-	0.437	0.328	0.375	4	055	○
	ANSI G	8.3	8.34	Y83662	2.5P	10.117	2.125	0.75	-	0.312	0.234	0.375	4	056	○
1/4-18	ANSI G	10.7	10.75	Y83663	2.5P	13.426	2.437	1.062	-	0.562	0.421	0.437	4	055	○
3/8-18	ANSI G	14.1	14.17	Y83664	2.5P	16.866	2.562	1.062	-	0.7	0.531	0.5	4	055	○
1/2-14	ANSI G	17.4	17.44	Y83665	2.5P	20.980	3.125	1.375	-	0.687	0.515	0.625	4	056	○
3/4-14	ANSI G	22.7	22.75	Y83666	2.5P	26.325	3.25	1.375	-	0.906	0.679	0.687	4	056	○
1 -11 1/2	ANSI G	28.5	28.6	Y83667	2.5P	32.934	3.75	1.75	-	1.125	0.843	0.812	4	056	○

- Intro
- SP**
- ANSI**
- SL
- PO
- ST
- ROLL
- CARBIDE
- LONG
- HAND TAPS
- EG (STI)
- SPECIAL THREADS, GAUGES
- THREAD MILLS
- DIES
- CENTER DRILLS
- Technical info

Intro

ZELX AL SP

MS Material Specific Series

Spiral Fluted Taps for Aluminium

SP

ANSI

SL



PO

Recommended Tapping Speeds Depending On Materials

ISO	Vc (m/min)
N1	10÷25 ★
N2	10÷25 ★
N3	10÷25 ★
N4	10÷25 ★

★ 1st choice ☆ suitable

ST

ROLL

CARBIDE

LONG

HAND TAPS

EG (STI)

SPECIAL THREADS, GAUGES

THREAD MILLS

DIES

CENTER DRILLS

Technical info



FEATURES

Material specific for blind hole application. Specific design and NI treatment allow stable and long life on Aluminium casting and die-casting.

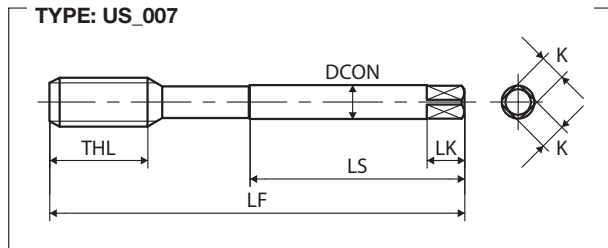
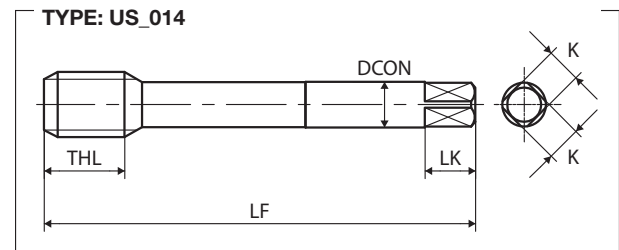
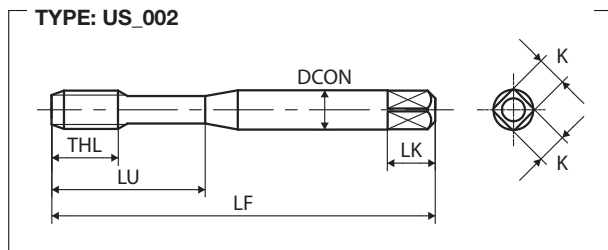

UNC	TCTR (tolerance)	 Hole Ø (mm)	Hole Ø (mm)	Code	THCHT (chamfer)	LF (inch)	LT (inch)	THL (inch)	LU (inch)	LS (inch)	DCON (inch)	K (inch)	LK (inch)	NOF	Type	Stock
ANSI																
No.2-56UNC	GH2	1.8	1.83	Y86500	2.5P	1.772	-	0.276	0.472	-	0.141	0.11	0.187	2	002	○
No.4-40UNC	GH2	2.3	2.33	Y86501	2.5P	2.205	-	0.433	0.709	-	0.141	0.11	0.187	2	002	○
No.5-40UNC	GH2	2.6	2.64	Y86502	2.5P	2.205	-	0.433	0.709	-	0.141	0.11	0.187	3	002	○
No.6-32UNC	GH3	2.8	2.83	Y86503	2.5P	2.205	-	0.512	0.787	-	0.141	0.11	0.187	3	002	○
No.8-32UNC	GH3	3.4	3.47	Y86504	2.5P	2.48	-	0.512	0.827	-	0.168	0.131	0.25	3	002	○
No.10-24UNC	GH3	3.89	3.9	Y86505	2.5P	2.756	-	0.63	0.984	-	0.194	0.152	0.25	3	002	○
1/4-20UNC	GH3	5.1	5.19	Y86507	2.5P	3.15	-	0.748	1.181	-	0.255	0.191	0.312	3	002	○
	GH5	5.1	5.19	Y86508	2.5P	3.15	-	0.748	1.181	-	0.255	0.191	0.312	3	002	○
5/16-18UNC	GH3	6.6	6.65	Y86512	2.5P	3.543	-	0.866	1.378	-	0.318	0.238	0.375	3	002	○
3/8-16UNC	GH3	8	8.07	Y86516	2.5P	3.937	-	0.945	1.535	-	0.381	0.286	0.437	3	002	○
	GH5	8	8.07	Y86517	2.5P	3.937	-	0.945	1.535	-	0.381	0.286	0.437	3	002	○
7/16-14UNC	GH3	9.4	9.45	Y86520	2.5P	3.937	-	0.945	-	-	0.323	0.242	0.406	3	014	○
1/2-13UNC	GH3	10.9	10.91	Y86524	2.5P	4.331	-	1.142	-	-	0.367	0.275	0.437	3	014	○
	GH5	10.9	10.91	Y86525	2.5P	4.331	-	1.142	-	-	0.367	0.275	0.437	3	007	○
UNF																
ANSI																
No.10-32UNF	GH3	4.1	4.12	Y86506	2.5P	2.756	-	0.63	0.984	-	0.194	0.152	0.25	3	002	○
1/4-28UNF	GH3	5.5	5.53	Y86509	2.5P	3.15	-	0.748	1.181	-	0.255	0.191	0.312	3	002	○
	GH4	5.5	5.53	Y86511	2.5P	3.15	-	0.748	1.181	-	0.255	0.191	0.312	3	002	○
3/8-24UNF	GH3	8.5	8.57	Y86518	2.5P	3.543	-	0.787	1.535	-	0.381	0.286	0.437	3	002	○
1/2-20UNF	GH3	11.5	11.54	Y86526	2.5P	3.937	-	0.866	-	-	0.367	0.275	0.437	3	007	○

- Intro
- SP**
- ANSI**
- SL
- PO
- ST
- ROLL
- CARBIDE
- LONG
- HAND TAPS
- EG (STI)
- SPECIAL THREADS, GAUGES
- THREAD MILLS
- DIES
- CENTER DRILLS
- Technical info

The most suitable GH tap class to cut accurate 2B, 3B (UNJ) and 2B oversized internal threads tolerance, depends on application conditions and work-piece materials. Yamawa GH class system offers a wide range of alternative tap classes allowing each customer to select the most suitable one according to application requirement. Check page 673 of Technical info for full details.

Intro

ZELX NI SP

MS Material Specific Series

Spiral Fluted Taps for Nickel Base Alloys

SP

ANSI

SL



PO

Recommended Tapping Speeds Depending On Materials

ISO	Vc (m/min)	ISO	Vc (m/min)	ISO	Vc (m/min)
P1	5÷15 ☆	M1	5÷15 ★	S1	5÷10 ★
P2	5÷15 ☆	M2	5÷15 ★	S2	5÷10 ★
P3	5÷15 ★	M3	4÷8 ★		
P4	5÷15 ★				
P5	5÷10 ☆				
P7	5÷15 ★				
P8	4÷8 ★				

★ 1st choice ☆ suitable

ST

ROLL

CARBIDE

LONG

HAND TAPS

EG (STI)

SPECIAL THREADS, GAUGES

THREAD MILLS

DIES

CENTER DRILLS

Technical info



FEATURES

Material specific for blind hole application.
 Specific design and NX treatment allow high performance on Nickel base alloys.
 Also suitable for stainless steel and high alloy steel.

TYPE: US_002

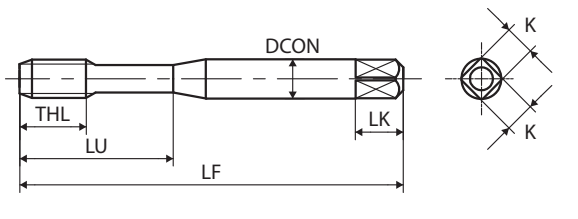

TYPE: US_014

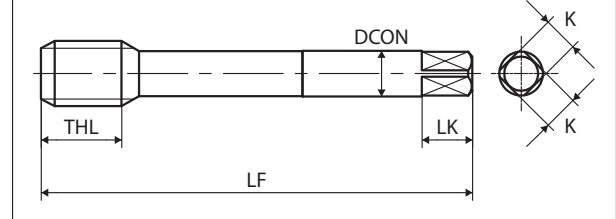

UNC	TCTR (tolerance)	\varnothing (mm)	Hole \varnothing (mm)	Code	THCHT (chamfer)	LF (inch)	LT (inch)	THL (inch)	LU (inch)	LS (inch)	DCON (inch)	K (inch)	LK (inch)	NOF	Type	Stock
ANSI																
No.2-56UNC	GH2	1.8	1.83	Y87523	3P	1.75	-	0.157	0.437	-	0.141	0.11	0.187	3	002	○
	GH2	2.3	2.33	Y87501	3P	1.875	-	0.236	0.562	-	0.141	0.11	0.187	3	002	○
No.4-40UNC	GH3	2.3	2.33	Y87502	3P	1.875	-	0.236	0.562	-	0.141	0.11	0.187	3	002	○
	GH3	2.3	2.33	Y87002	1.5P	1.875	-	0.236	0.562	-	0.141	0.11	0.187	3	002	○
	GH2	2.3	2.33	Y87583	1.5P	1.875	-	0.236	0.562	-	0.141	0.11	0.187	3	002	○
	GH4	2.3	2.33	Y87512	3P	1.875	-	0.236	0.562	-	0.141	0.11	0.187	3	002	○
	GH5	2.3	2.33	Y87534	3P	1.875	-	0.236	0.562	-	0.141	0.11	0.187	3	002	○
	GH5	2.3	2.33	Y87072	1.5P	1.875	-	0.236	0.562	-	0.141	0.11	0.187	3	002	○
No.5-40UNC	GH2	2.6	2.64	Y87503	3P	1.937	-	0.236	0.625	-	0.141	0.11	0.187	3	002	○
No.6-32UNC	GH2	2.8	2.83	Y87504	3P	2	-	0.276	0.687	-	0.141	0.11	0.187	3	002	○
	GH2	2.8	2.83	Y87006	1.5P	2	-	0.276	0.687	-	0.141	0.11	0.187	3	002	○
	GH3	2.8	2.83	Y87505	3P	2	-	0.276	0.687	-	0.141	0.11	0.187	3	002	○
	GH3	2.8	2.83	Y87005	1.5P	2	-	0.276	0.687	-	0.141	0.11	0.187	3	002	○
	GH4	2.8	2.83	Y87508	3P	2	-	0.276	0.687	-	0.141	0.11	0.187	3	002	○
	GH5	2.8	2.83	Y87535	3P	2	-	0.276	0.687	-	0.141	0.11	0.187	3	002	○
	GH5	2.8	2.83	Y87035	1.5P	2	-	0.276	0.687	-	0.141	0.11	0.187	3	002	○
	GH6	2.8	2.83	Y87559	3P	2	-	0.276	0.687	-	0.141	0.11	0.187	3	002	○
No.8-32UNC	GH7	2.8	2.83	Y87565	3P	2	-	0.276	0.687	-	0.141	0.11	0.187	3	002	○
	GH2	3.4	3.47	Y87506	3P	2.125	-	0.276	0.75	-	0.168	0.131	0.25	3	002	○
	GH3	3.4	3.47	Y87507	3P	2.125	-	0.276	0.75	-	0.168	0.131	0.25	3	002	○
	GH3	3.4	3.47	Y87580	1.5P	2.125	-	0.276	0.75	-	0.168	0.131	0.25	3	002	○
	GH4	3.4	3.47	Y87529	3P	2.125	-	0.276	0.75	-	0.168	0.131	0.25	3	002	○
	GH5	3.4	3.47	Y87537	3P	2.125	-	0.276	0.75	-	0.168	0.131	0.25	3	002	○
	GH5	3.4	3.47	Y87037	1.5P	2.125	-	0.276	0.75	-	0.168	0.131	0.25	3	002	○
	GH6	3.4	3.47	Y87560	3P	2.125	-	0.276	0.75	-	0.168	0.131	0.25	3	002	○
No.10-24UNC	GH7	3.4	3.47	Y87567	3P	2.125	-	0.276	0.75	-	0.168	0.131	0.25	3	002	○
	GH3	3.89	3.9	Y87509	3P	2.375	-	0.354	0.875	-	0.194	0.152	0.25	3	002	○
	GH3	3.89	3.9	Y87009	1.5P	2.375	-	0.354	0.875	-	0.194	0.152	0.25	3	002	○
	GH5	3.89	3.9	Y87539	3P	2.375	-	0.354	0.875	-	0.194	0.152	0.25	3	002	○
1/4-20UNC	GH5	3.89	3.9	Y87039	1.5P	2.375	-	0.354	0.875	-	0.194	0.152	0.25	3	002	○
	GH3	5.1	5.19	Y87513	3P	2.5	-	0.433	1	-	0.255	0.191	0.312	3	002	○
	GH3	5.1	5.19	Y87013	1.5P	2.5	-	0.433	1	-	0.255	0.191	0.312	3	002	○
	GH5	5.1	5.19	Y87543	3P	2.5	-	0.433	1	-	0.255	0.191	0.312	3	002	○
5/16-18UNC	GH5	5.1	5.19	Y87043	1.5P	2.5	-	0.433	1	-	0.255	0.191	0.312	3	002	○
	GH3	6.6	6.65	Y87515	3P	2.718	-	0.472	1.125	-	0.318	0.238	0.375	3	002	○
	GH3	6.6	6.65	Y87015	1.5P	2.718	-	0.472	1.125	-	0.318	0.238	0.375	3	002	○
	GH5	6.6	6.65	Y87545	3P	2.718	-	0.472	1.125	-	0.318	0.238	0.375	3	002	○
3/8-16UNC	GH5	6.6	6.65	Y87045	1.5P	2.718	-	0.472	1.125	-	0.318	0.238	0.375	3	002	○
	GH3	8	8.07	Y87517	3P	2.937	-	0.551	1.25	-	0.381	0.286	0.437	3	002	○
	GH3	8	8.07	Y87017	1.5P	2.937	-	0.551	1.25	-	0.381	0.286	0.437	3	002	○
	GH5	8	8.07	Y87547	3P	2.937	-	0.551	1.25	-	0.381	0.286	0.437	3	002	○
7/16-14UNC	GH5	8	8.07	Y87047	1.5P	2.937	-	0.551	1.25	-	0.381	0.286	0.437	3	002	○
	GH3	9.4	9.45	Y87519	3P	3.156	-	0.591	-	-	0.323	0.242	0.406	3	014	○
7/16-14UNC	GH5	9.4	9.45	Y87549	3P	3.156	-	0.591	-	-	0.323	0.242	0.406	3	014	○

Intro

SP

ANSI

SL

PO

ST

ROLL

CARBIDE

LONG

HAND TAPS

EG (STI)

SPECIAL THREADS, GAUGES

THREAD MILLS

DIES

CENTER DRILLS

Technical info

The most suitable GH tap class to cut accurate 2B, 3B (UNJ) and 2B oversized internal threads tolerance, depends on application conditions and work-piece materials. Yamawa GH class system offers a wide range of alternative tap classes allowing each customer to select the most suitable one according to application requirement. Check page 673 of Technical info for full details.

Spiral Fluted Taps

Intro

SP

ANSI

SL

PO

ST

ROLL

CARBIDE

LONG

HAND TAPS

EG (STI)

SPECIAL THREADS, GAUGES

THREAD MILLS

DIES

CENTER DRILLS

Technical info

UNC	TCTR (tolerance)	\varnothing (mm)	Hole \varnothing (mm)	Code	THCHT (chamfer)	LF (inch)	LT (inch)	THL (inch)	LU (inch)	LS (inch)	DCON (inch)	K (inch)	LK (inch)	NOF	Type	Stock
ANSI																
1/2-13UNC	GH3	10.9	10.91	Y87521	3P	3.375	-	0.630	-	-	0.367	0.275	0.437	3	014	○
	GH3	10.9	10.91	Y87500	1.5P	3.375	-	0.630	-	-	0.367	0.275	0.437	3	014	○
	GH5	10.9	10.91	Y87551	3P	3.375	-	0.630	-	-	0.367	0.275	0.437	3	014	○
	GH5	10.9	10.91	Y87051	1.5P	3.375	-	0.630	-	-	0.367	0.275	0.437	3	014	○
	GH7	10.9	10.91	Y87581	3P	3.375	-	0.630	-	-	0.367	0.275	0.437	3	014	○
5/8-11UNC	GH3	13.6	13.75	Y87525	3P	3.812	-	0.748	-	-	0.48	0.36	0.562	4	014	○
	GH5	13.6	13.75	Y87555	3P	3.812	-	0.748	-	-	0.48	0.36	0.562	4	014	○
	GH7	13.6	13.75	Y87585	3P	3.812	-	0.748	-	-	0.48	0.36	0.562	4	014	○
3/4-10UNC	GH3	16.6	16.7	Y87025	3P	3.812	-	0.748	-	-	0.48	0.36	0.562	4	014	○
	GH3	16.6	16.7	Y87527	3P	4.25	-	0.827	-	-	0.59	0.442	0.687	4	014	○
	GH3	16.6	16.7	Y87027	1.5P	4.25	-	0.827	-	-	0.59	0.442	0.687	4	014	○
GH5	16.6	16.7	Y87557	3P	4.25	-	0.827	-	-	0.59	0.442	0.687	4	014	○	
ANSI																
No.10-32UNF	GH2	4.1	4.12	Y87511	3P	2.375	-	0.276	0.875	-	0.194	0.152	0.25	3	002	○
	GH3	4.1	4.12	Y87510	3P	2.375	-	0.276	0.875	-	0.194	0.152	0.25	3	002	●
	GH3	4.1	4.12	Y81556	1.5P	2.375	-	0.276	0.875	-	0.194	0.152	0.25	3	002	○
	GH4	4.1	4.12	Y87530	3P	2.375	-	0.276	0.875	-	0.194	0.152	0.25	3	002	○
	GH5	4.1	4.12	Y87540	3P	2.375	-	0.276	0.875	-	0.194	0.152	0.25	3	002	○
	GH5	4.1	4.12	Y87040	1.5P	2.375	-	0.276	0.875	-	0.194	0.152	0.25	3	002	○
	GH6	4.1	4.12	Y87561	3P	2.375	-	0.276	0.875	-	0.194	0.152	0.25	3	002	○
	GH7	4.1	4.12	Y87570	3P	2.375	-	0.276	0.875	-	0.194	0.152	0.25	3	002	○
1/4-28UNF	GH3	5.5	5.53	Y87514	3P	2.5	-	0.354	1	-	0.255	0.191	0.312	3	002	●
	GH3	5.5	5.53	Y87579	1.5P	2.5	-	0.354	1	-	0.255	0.191	0.312	3	002	○
	GH4	5.5	5.53	Y87531	3P	2.5	-	0.354	1	-	0.255	0.191	0.312	3	002	○
	GH4	5.5	5.53	Y87031	1.5P	2.5	-	0.354	1	-	0.255	0.191	0.312	3	002	○
	GH5	5.5	5.53	Y87544	3P	2.5	-	0.354	1	-	0.255	0.191	0.312	3	002	○
	GH5	5.5	5.53	Y87443	1.5P	2.5	-	0.354	1	-	0.255	0.191	0.312	3	002	○
	GH6	5.5	5.53	Y87562	3P	2.5	-	0.354	1	-	0.255	0.191	0.312	3	002	○
5/16-24UNF	GH7	5.5	5.53	Y87574	3P	2.5	-	0.354	1	-	0.255	0.191	0.312	3	002	○
	GH3	6.9	6.97	Y87516	3P	2.718	-	0.394	1.125	-	0.318	0.238	0.375	3	002	●
	GH3	6.9	6.97	Y87577	1.5P	2.718	-	0.394	1.125	-	0.318	0.238	0.375	3	002	○
	GH4	6.9	6.97	Y87532	3P	2.718	-	0.394	1.125	-	0.318	0.238	0.375	3	002	○
	GH5	6.9	6.97	Y87546	3P	2.718	-	0.394	1.125	-	0.318	0.238	0.375	3	002	○
	GH6	6.9	6.97	Y87563	3P	2.718	-	0.394	1.125	-	0.318	0.238	0.375	3	002	○
3/8-24UNF	GH7	6.9	6.97	Y87576	3P	2.718	-	0.394	1.125	-	0.318	0.238	0.375	3	002	○
	GH4	6.9	6.97	Y87032	3P	2.718	-	0.394	1.125	-	0.318	0.238	0.375	3	002	○
	GH3	8.5	8.57	Y87518	3P	2.937	-	0.394	1.25	-	0.381	0.286	0.437	3	002	●
	GH4	8.5	8.57	Y87533	3P	2.937	-	0.394	1.25	-	0.381	0.286	0.437	3	002	○
	GH4	8.5	8.57	Y87033	1.5P	2.937	-	0.394	1.25	-	0.381	0.286	0.437	3	002	○
	GH5	8.5	8.57	Y87548	3P	2.937	-	0.394	1.25	-	0.381	0.286	0.437	3	002	○
CENTER DRILLS	GH6	8.5	8.57	Y87564	3P	2.937	-	0.394	1.25	-	0.381	0.286	0.437	3	002	○
	GH7	8.5	8.57	Y87578	3P	2.937	-	0.394	1.25	-	0.381	0.286	0.437	3	002	○
	GH3	8.5	8.57	Y87575	3P	2.937	-	0.394	1.25	-	0.381	0.286	0.437	3	002	○

UNF	TCTR (tolerance)	Hole Ø (mm)	Hole Ø (mm)	Code	THCHT (chamfer)	LF (inch)	LT (inch)	THL (inch)	LU (inch)	LS (inch)	DCON (inch)	K (inch)	LK (inch)	NOF	Type	Stock
ANSI																
7/16-20UNF	GH3	9.9	9.96	Y87520	3P	3.156	-	0.472	-	-	0.323	0.242	0.406	3	014	○
	GH3	9.9	9.96	Y87573	1.5P	3.156	-	0.472	-	-	0.323	0.242	0.406	3	014	○
	GH5	9.9	9.96	Y87550	3P	3.156	-	0.472	-	-	0.323	0.242	0.406	3	014	○
	GH5	9.9	9.96	Y87050	1.5P	3.156	-	0.472	-	-	0.323	0.242	0.406	3	014	○
1/2-20UNF	GH3	11.5	11.54	Y87522	3P	3.375	-	0.472	-	-	0.367	0.275	0.437	3	014	○
	GH3	11.5	11.54	Y87022	1.5P	3.375	-	0.472	-	-	0.367	0.275	0.437	3	014	○
	GH5	11.5	11.54	Y87552	3P	3.375	-	0.472	-	-	0.367	0.275	0.437	3	014	○
	GH7	11.5	11.54	Y87582	3P	3.375	-	0.472	-	-	0.367	0.275	0.437	3	014	○
9/16-18UNF	GH3	12.9	13	Y88554	3P	3.593	-	0.512	-	-	0.429	0.322	0.5	3	014	○
	GH5	12.9	13	Y88542	3P	3.593	-	0.512	-	-	0.429	0.322	0.5	3	014	○
5/8-18UNF	GH3	14.5	14.6	Y87526	3P	3.812	-	0.512	-	-	0.48	0.36	0.562	4	014	○
	GH3	14.5	14.6	Y81508	1.5P	3.812	-	0.512	-	-	0.48	0.36	0.562	4	014	○
	GH4	14.5	14.6	Y87536	3P	3.812	-	0.512	-	-	0.48	0.36	0.562	4	014	○
	GH5	14.5	14.6	Y87556	3P	3.812	-	0.512	-	-	0.48	0.36	0.562	4	014	○
	GH7	14.5	14.6	Y87586	3P	3.812	-	0.512	-	-	0.48	0.36	0.562	4	014	○
3/4-16UNF	GH3	17.5	17.59	Y87528	3P	4.25	-	0.591	-	-	0.59	0.442	0.687	4	014	○
	GH5	17.5	17.59	Y87558	3P	4.25	-	0.591	-	-	0.59	0.442	0.687	4	014	○

- Intro
- SP**
- ANSI**
- SL
- PO
- ST
- ROLL
- CARBIDE
- LONG
- HAND TAPS
- EG (STI)
- SPECIAL THREADS, GAUGES
- THREAD MILLS
- DIES
- CENTER DRILLS
- Technical info

The most suitable GH tap class to cut accurate 2B, 3B (UNJ) and 2B oversized internal threads tolerance, depends on application conditions and work-piece materials. Yamawa GH class system offers a wide range of alternative tap classes allowing each customer to select the most suitable one according to application requirement. Check page 673 of Technical info for full details.

Intro

ZELX TI SP



MS Material Specific Series

Low Spiral Fluted Taps for Titanium Base Alloys

SP

ANSI

SL



PO

Recommended Tapping Speeds Depending On Materials

ISO	Vc (m/min)	ISO	Vc (m/min)	ISO	Vc (m/min)	ISO	Vc (m/min)
P4	5÷10 ☆	M3	3÷6 ☆	K2	5÷10 ☆	S1	5÷10 ☆
P5	5÷8 ☆			K3	5÷10 ☆	S2	5÷10 ☆
P6	3÷6 ☆					S3	3÷6 ☆
P8	3÷6 ☆					S5	5÷10 ★

★ 1st choice ☆ suitable

ROLL

CARBIDE

LONG

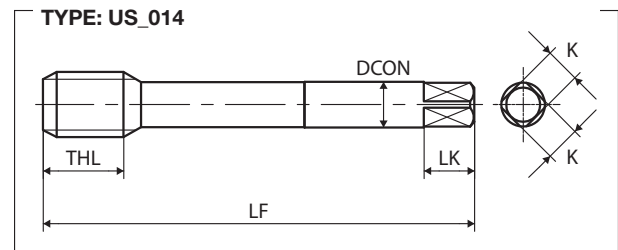
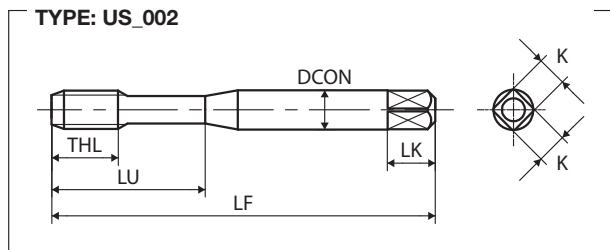

HAND TAPS

EG (STI)

SPECIAL THREADS, GAUGES

THREAD MILLS

DIES

CENTER DRILLS

UNC	TCTR (tolerance)	Hole Ø (mm)	Hole Ø (mm)	Code	THCHT (chamfer)	LF (inch)	LT (inch)	THL (inch)	LU (inch)	LS (inch)	DCON (inch)	K (inch)	LK (inch)	NOF	Type	Stock
ANSI																
No.2-56UNC	GH2	1.8	1.83	Y87623	3P	1.75	-	0.157	0.437	-	0.141	0.11	0.187	3	002	○
	GH2	2.3	2.33	Y87601	3P	1.875	-	0.236	0.562	-	0.141	0.11	0.187	3	002	○
No.4-40UNC	GH4	2.3	2.33	Y87612	3P	1.875	-	0.236	0.562	-	0.141	0.11	0.187	3	002	○
	GH4	2.3	2.33	Y87001	1.5P	1.875	-	0.236	0.562	-	0.141	0.11	0.187	3	002	○
No.6-32UNC	GH3	2.8	2.83	Y87605	3P	2	-	0.276	0.687	-	0.141	0.11	0.187	3	002	○
	GH3	2.8	2.83	Y87606	1.5P	2	-	0.276	0.687	-	0.141	0.11	0.187	3	002	○
	GH4	2.8	2.83	Y87608	3P	2	-	0.276	0.687	-	0.141	0.11	0.187	3	002	○
No.8-32UNC	GH5	2.8	2.83	Y87635	3P	2	-	0.276	0.687	-	0.141	0.11	0.187	3	002	○
	GH3	3.4	3.47	Y87607	3P	2.125	-	0.276	0.75	-	0.168	0.131	0.25	3	002	○
	GH3	3.4	3.47	Y87007	1.5P	2.125	-	0.276	0.75	-	0.168	0.131	0.25	3	002	○
No.10-24UNC	GH4	3.4	3.47	Y87629	3P	2.125	-	0.276	0.75	-	0.168	0.131	0.25	3	002	○
	GH5	3.4	3.47	Y87637	3P	2.125	-	0.276	0.75	-	0.168	0.131	0.25	3	002	○
	GH6	3.4	3.47	Y87660	3P	2.125	-	0.276	0.75	-	0.168	0.131	0.25	3	002	○
No.10-24UNC	GH3	3.89	3.9	Y87609	3P	2.375	-	0.354	0.875	-	0.194	0.152	0.25	3	002	○
	GH3	3.89	3.9	Y81608	1.5P	2.375	-	0.354	0.875	-	0.194	0.152	0.25	3	002	○



FEATURES

Material specific for blind hole application.

Specific design and NI treatment allow high performance on Titanium base alloys.

Also suitable for high tensile strength steel, high alloy steel and cast iron.

Technical info

UNC	TCTR (tolerance)	 Hole Ø (mm)	Hole Ø (mm)	Code	THCHT (chamfer)	LF (inch)	LT (inch)	THL (inch)	LU (inch)	LS (inch)	DCON (inch)	K (inch)	LK (inch)	NOF	Type	Stock
ANSI																
1/4-20UNC	GH3	5.1	5.19	Y87613	3P	2.5	-	0.433	1	-	0.255	0.191	0.312	3	002	○
	GH3	5.1	5.19	Y87628	1.5P	2.5	-	0.433	1	-	0.255	0.191	0.312	3	002	○
5/16-18UNC	GH3	6.6	6.65	Y87615	3P	2.718	-	0.472	1.125	-	0.318	0.238	0.375	3	002	○
	GH3	6.6	6.65	Y87695	1.5P	2.718	-	0.472	1.125	-	0.318	0.238	0.375	3	002	○
3/8-16UNC	GH3	8	8.07	Y87617	3P	2.937	-	0.551	1.25	-	0.381	0.286	0.437	3	002	○
	GH3	8	8.07	Y87611	1.5P	2.937	-	0.551	1.25	-	0.381	0.286	0.437	3	002	○
7/16-14UNC	GH3	9.4	9.45	Y87619	3P	3.156	-	0.591	-	-	0.323	0.242	0.406	3	014	○
	GH3	9.4	9.45	Y81629	1.5P	3.156	-	0.591	-	-	0.323	0.242	0.406	3	014	○
1/2-13UNC	GH3	10.9	10.91	Y87621	3P	3.375	-	0.630	-	-	0.367	0.275	0.437	3	014	○
	GH3	10.9	10.91	Y87021	1.5P	3.375	-	0.630	-	-	0.367	0.275	0.437	3	014	○
	GH5	10.9	10.91	Y87626	3P	3.375	-	0.630	-	-	0.367	0.275	0.437	3	014	○
UNF	TCTR (tolerance)	 Hole Ø (mm)	Hole Ø (mm)	Code	THCHT (chamfer)	LF (inch)	LT (inch)	THL (inch)	LU (inch)	LS (inch)	DCON (inch)	K (inch)	LK (inch)	NOF	Type	Stock
ANSI																
No.10-32UNF	GH3	4.1	4.12	Y87610	3P	2.375	-	0.276	0.875	-	0.194	0.152	0.25	3	002	●
	GH3	4.1	4.12	Y87010	1.5P	2.375	-	0.276	0.875	-	0.194	0.152	0.25	3	002	○
	GH4	4.1	4.12	Y87630	3P	2.375	-	0.276	0.875	-	0.194	0.152	0.25	3	002	○
	GH5	4.1	4.12	Y87640	3P	2.375	-	0.276	0.875	-	0.194	0.152	0.25	3	002	○
	GH6	4.1	4.12	Y87661	3P	2.375	-	0.276	0.875	-	0.194	0.152	0.25	3	002	○
	GH7	4.1	4.12	Y87670	3P	2.375	-	0.276	0.875	-	0.194	0.152	0.25	3	002	○
1/4-28UNF	GH3	5.5	5.53	Y87614	3P	2.5	-	0.354	1	-	0.255	0.191	0.312	3	002	●
	GH3	5.5	5.53	Y87014	1.5P	2.5	-	0.354	1	-	0.255	0.191	0.312	3	002	○
	GH4	5.5	5.53	Y87631	3P	2.5	-	0.354	1	-	0.255	0.191	0.312	3	002	○
	GH5	5.5	5.53	Y87644	3P	2.5	-	0.354	1	-	0.255	0.191	0.312	3	002	○
	GH6	5.5	5.53	Y87662	3P	2.5	-	0.354	1	-	0.255	0.191	0.312	3	002	○
	GH7	5.5	5.53	Y87674	3P	2.5	-	0.354	1	-	0.255	0.191	0.312	3	002	○
5/16-24UNF	GH3	6.9	6.97	Y87616	3P	2.718	-	0.394	1.125	-	0.318	0.238	0.375	3	002	●
	GH3	6.9	6.97	Y87016	1.5P	2.718	-	0.394	1.125	-	0.318	0.238	0.375	3	002	○
	GH4	6.9	6.97	Y87632	3P	2.718	-	0.394	1.125	-	0.318	0.238	0.375	3	002	○
	GH5	6.9	6.97	Y87646	3P	2.718	-	0.394	1.125	-	0.318	0.238	0.375	3	002	○
	GH6	6.9	6.97	Y87663	3P	2.718	-	0.394	1.125	-	0.318	0.238	0.375	3	002	○
	GH7	6.9	6.97	Y87676	3P	2.718	-	0.394	1.125	-	0.318	0.238	0.375	3	002	○
3/8-24UNF	GH3	8.5	8.57	Y87618	3P	2.937	-	0.394	1.25	-	0.381	0.286	0.437	3	002	●
	GH4	8.5	8.57	Y87633	3P	2.937	-	0.394	1.25	-	0.381	0.286	0.437	3	002	○
	GH5	8.5	8.57	Y87648	3P	2.937	-	0.394	1.25	-	0.381	0.286	0.437	3	002	○
	GH6	8.5	8.57	Y87664	3P	2.937	-	0.394	1.25	-	0.381	0.286	0.437	3	002	○
	GH7	8.5	8.57	Y87678	3P	2.937	-	0.394	1.25	-	0.381	0.286	0.437	3	002	○
	GH3	8.5	8.57	Y87018	1.5P	2.937	-	0.394	1.25	-	0.381	0.286	0.437	3	002	○
7/16-20UNF	GH3	9.9	9.96	Y87620	3P	3.156	-	0.472	-	-	0.323	0.242	0.406	3	014	○
	GH3	9.9	9.96	Y87020	1.5P	3.156	-	0.472	-	-	0.323	0.242	0.406	3	014	○
	GH5	9.9	9.96	Y87650	3P	3.156	-	0.472	-	-	0.323	0.242	0.406	3	014	○
1/2-20UNF	GH3	11.5	11.54	Y87622	3P	3.375	-	0.472	-	-	0.367	0.275	0.437	3	014	○
	GH3	11.5	11.54	Y87023	1.5P	3.375	-	0.472	-	-	0.367	0.275	0.437	3	014	○
	GH5	11.5	11.54	Y87652	3P	3.375	-	0.472	-	-	0.367	0.275	0.437	3	014	○

The most suitable GH tap class to cut accurate 2B, 3B (UNJ) and 2B oversized internal threads tolerance, depends on application conditions and work-piece materials. Yamawa GH class system offers a wide range of alternative tap classes allowing each customer to select the most suitable one according to application requirement. Check page 673 of Technical info for full details.

Intro

SP

ANSI

SL

PO

ST

ROLL

CARBIDE

LONG

HAND TAPS

EG (STI)

SPECIAL THREADS, GAUGES

THREAD MILLS

DIES

CENTER DRILLS

Technical info

LEFT SPIRAL FLUTED TAPS



SL - DIN **194**
SL - ANSI **204**

Selection Chart

Intro

SP

SL

PO

ST

ROLL

CARBIDE

LONG

HAND TAPS

EG (STI)

SPECIAL THREADS, GAUGES

THREAD MILLS

DIES

CENTER DRILLS

Technical info

	Z-PRO		MP Multi Purpose				MS Material Specific				HS High Speed					
	MHSL		AU+SL		AUXSL		SL+VA		ZET-P		ZELX TI LHSP		F-SL		HDISL	
	HSS-Co	COATING	HSS-E	COATING	HSS-E	COATING	HSS-E	OX	HSS-P	NI	HSS-P	NI	HSS-E	COATING	HSS-Co	COATING
	DIN	DIN	DIN	DIN	DIN	DIN	DIN	DIN	DIN	ANSI	DIN	DIN	DIN	DIN	DIN	DIN
M	195		197		198		199		201				202		203	
MF	195		197						201				202		203	
UNC/UNF										204						
UNS, 8, 12, 20, 32UN																
UNEF																
G (BSP)																
Rp (BSPP)																
Rc (BSPT)																
NPT																
NPTF																
NPSC, NPSM, NPSF																
BSW																
EG(STI), M, MF, UNC/UNF																
Pg																
Tr																
S miniature																
Special threads																
	Vc (m/min)															
P1		★	10÷20	★	10÷25	★	10÷15					★	15÷25	★	20÷50	
P2	★	10÷30	★	10÷20	★	10÷25	★	10÷15				★	15÷25	★	20÷50	
P3	★	10÷25	★	10÷20	★	10÷25	★	≤10				☆	15÷25	★	20÷30	
P4	★	10÷20	★	10÷20	★	10÷25	☆	≤10	☆	5÷10	☆	5÷10	☆	15÷25	★	20÷30
P5	☆	10÷15							☆	5÷8	☆	5÷8			☆	15÷25
P6									☆	3÷6	☆	3÷6				
P7	☆	10÷20	★	5÷12	★	10÷15	★	5÷15					☆	10÷20	☆	15÷30
P8									☆	3÷6	☆	3÷6				
M1	☆	10÷20	★	5÷12	★	10÷15	★	5÷15					☆	10÷20	☆	15÷30
M2			★	5÷10	★	10÷15	☆	5÷10					☆	10÷20	☆	15÷25
M3									☆	3÷6	☆	3÷6				
K1													☆	15÷25	★	20÷40
K2			☆	10÷15	☆	10÷25			☆	5÷10	☆	5÷10	☆	15÷25	★	20÷40
K3									☆	5÷10	☆	5÷10				
K4																
N1			★	20÷30	★	20÷30							★	15÷30	★	30÷100
N2			★	20÷30	★	20÷30							★	15÷30	★	30÷100
N3			☆	15÷25	☆	15÷25										
N4			☆	15÷25	☆	15÷25							☆	15÷25	☆	30÷60
N5																
S1 (<25 HRC)									☆	5÷10	☆	5÷10				
S2 (<35 HRC)									☆	5÷10	☆	5÷10				
S3 (35 ÷ 45 HRC)									★	3÷6	☆	3÷6				
S5									★	5÷10	★	5÷10				
H (45 ÷ 55 HRC)																
H (55 ÷ 63 HRC)																

★ 1st choice ☆ suitable

Intro

SP

SL

PO

ST

ROLL

CARBIDE

LONG

HAND
TAPS

EG (STI)

SPECIAL
THREADS,
GAUGES

THREAD
MILLS

DIES

CENTER
DRILLS

Technical
info

Intro

MHSL

Z-PRO Series

Left Spiral Fluted Taps for Carbon Steel of Medium Hardness, Coated



SP

SL

DIN



FEATURES

Z-PRO Series for Medium Hardness workpiece materials. Most suitable for high carbon steel (C48 ÷ C55) and alloy steel 20 ÷ 30HRC. Long life thanks to HSSCo substrate and special coating. Left hand spiral design allows smooth chip ejection.

PO

Recommended Tapping Speeds Depending On Materials

ISO	Vc (m/min)	ISO	Vc (m/min)
P2	10÷30 ★	M1	10÷20 ☆
P3	10÷25 ★		
P4	10÷20 ★		
P5	10÷15 ☆		
P7	10÷20 ☆		

★ 1st choice ☆ suitable

ST

ROLL



WATCH THE VIDEO

Product Features

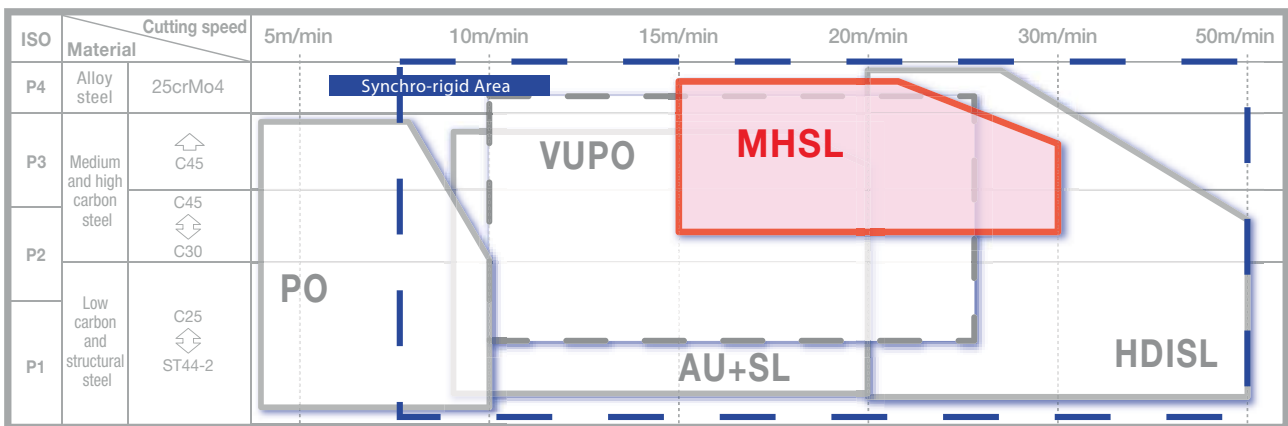

CARBIDE

LONG

HAND TAPS

EG (STI)

M12x1.25

Work-material	S53C (25HRC)
Tapping length	13 mm
Tapping speed	30 m/min
Machine	CNC machine
Lubricant	Water soluble oil

SPECIAL THREADS, GAUGES

THREAD MILLS

DIES

Flute design

To improve the chip ejection, MHSL series is designed with special flute shape to push out the chips smoothly.

Chip shape

The chips generated by MHSL special flute design, feature regular and narrow shape very easy to be ejected.

Thread finishing

Innovative geometry combined with suitable coating result in excellent thread finishing.

CENTER DRILLS



MHSL

Competitor



Technical info

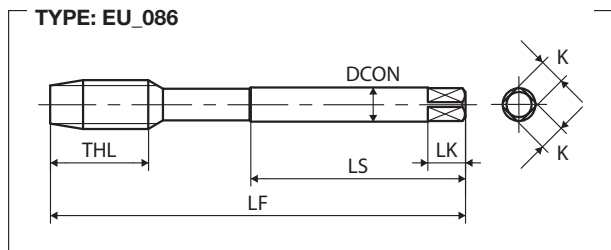
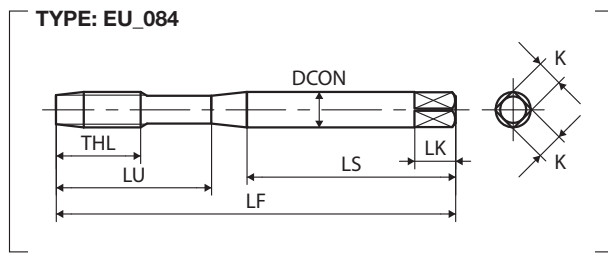
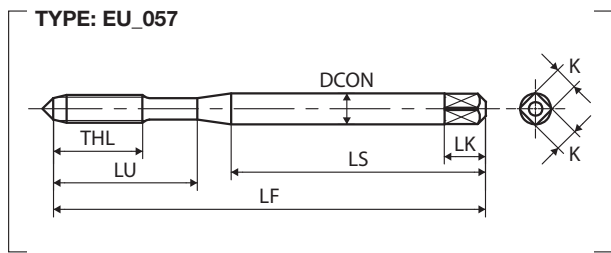

M	TCTR (tolerance)	\varnothing (mm)	Hole \varnothing (mm)	Code	THCHT (chamfer)	LF (mm)	THL (mm)	LU (mm)	LS (mm)	DCON (mm)	K (mm)	LK (mm)	NOF	Type	Stock
DIN 371															
M6X1	IS02X(6HX)	5	5.09	LD6.0MBFCL5	5P	80	15	30	45	6	4.9	8	3	057	●
M8X1.25	IS02X(6HX)	6.8	6.85	LD8.0MBFCL5	5P	90	19	35	47	8	6.2	9	3	084	●
M10X1.5	IS02X(6HX)	8.5	8.6	LD0100BFCL5	5P	100	23	39	52	10	8	11	3	084	●
M	TCTR (tolerance)	\varnothing (mm)	Hole \varnothing (mm)	Code	THCHT (chamfer)	LF (mm)	THL (mm)	LU (mm)	LS (mm)	DCON (mm)	K (mm)	LK (mm)	NOF	Type	Stock
DIN 376															
M12X1.75	IS02X(6HX)	10.3	10.36	LG012PBFCL5	5P	110	26	-	56	9	7	10	4	086	●
MF	TCTR (tolerance)	\varnothing (mm)	Hole \varnothing (mm)	Code	THCHT (chamfer)	LF (mm)	THL (mm)	LU (mm)	LS (mm)	DCON (mm)	K (mm)	LK (mm)	NOF	Type	Stock
DIN 374															
M10X1.25	IS02X(6HX)	8.8	8.85	LM010NBFCL5	5P	100	23	-	51	7	5.5	8	3	086	●
M12X1.5	IS02X(6HX)	10.5	10.6	LM0120BFCL5	5P	100	21	-	51	9	7	10	4	086	●
M12X1.25	IS02X(6HX)	10.8	10.85	LM012NBFCL7	7P	100	21	-	51	9	7	10	4	086	●
M14X1.5	IS02X(6HX)	12.5	12.6	LM0140BFCL7	7P	100	21	-	51	11	9	12	4	086	●
M16X1.5	IS02X(6HX)	14.5	14.6	LM0160BFCL7	7P	100	21	-	51	12	9	12	4	086	●

Intro

SP

SL

DIN

PO

ST

ROLL

CARBIDE

LONG

HAND
TAPS

EG (STI)

SPECIAL
THREADS,
GAUGESTHREAD
MILLS

DIES

CENTER
DRILLSTechnical
info

Intro

AU+SL

MP Multi Purpose Series

Plus Series Left Spiral Fluted Taps, Coated



SP

SL

DIN



Recommended Tapping Speeds Depending On Materials

ISO	Vc (m/min)	★	ISO	Vc (m/min)	★	ISO	Vc (m/min)	☆	ISO	Vc (m/min)	★
P1	10÷20	★	M1	5÷12	★	K2	10÷15	☆	N1	20÷30	★
P2	10÷20	★	M2	5÷10	★				N2	20÷30	★
P3	10÷20	★							N3	15÷25	☆
P4	10÷20	★							N4	15÷25	☆
P7	5÷12	★									

★ 1st choice ☆ suitable

PO

ST

ROLL

CARBIDE

LONG

HAND TAPS

EG (STI)

SPECIAL THREADS, GAUGES

THREAD MILLS

DIES

CENTER DRILLS

Technical info

FEATURES

Multi purpose for through hole application on a wide range of materials.

Left hand helix design improves chip ejection even at higher cutting speed.

Suitable coating improves wear, heat and welding resistance.

versionUP+ Product Features

Smooth chip ejection

Special left hand spiral flute design enables the smooth chip ejection even in high speed tapping area, on a wide range of work materials.

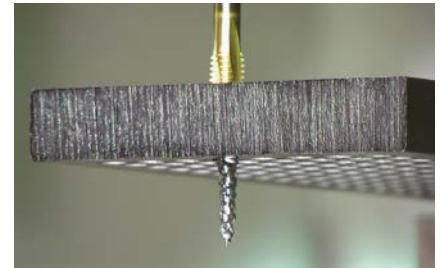

Change of marking position from shank into square portion

Laser marking can roughen the shank surface. In order to keep high accuracy of shank circularity and diameter, marking has been transferred from shank to square portion.



Wear resistance on a wide range of materials

AU+SL adopts a special flute design enabling coating features to show their best efficiency, allowing high wear resistance on a wide range of work materials

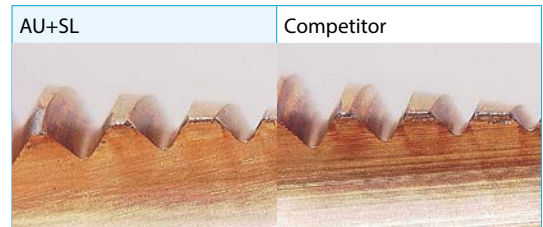

M6x1

Work-material	42 CrMo 4 - 1.7225
Tapping length	9mm, through hole
Tapping speed	15m/min
Machine	Vertical machining center
Lubricant	Water soluble oil (x20)
Hole size	φ5.0

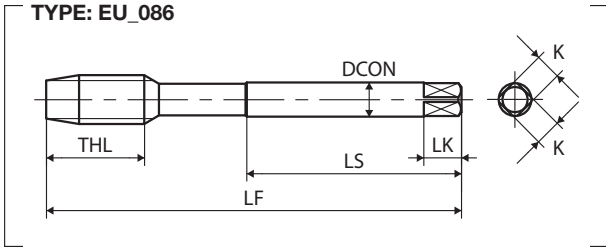
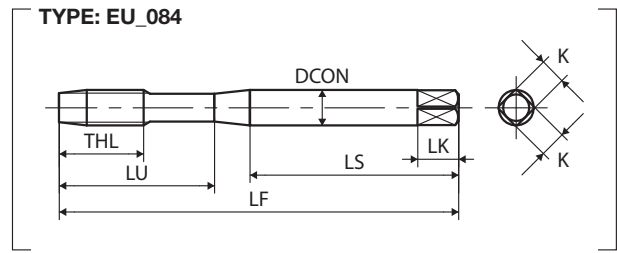
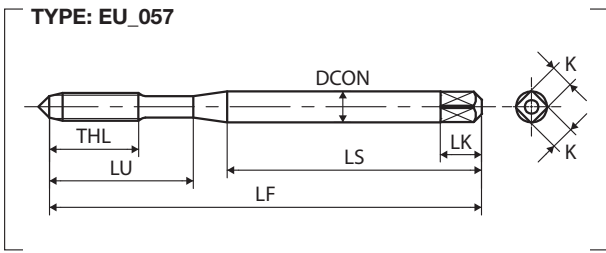

M	TCTR (tolerance)	\varnothing (mm)	Hole \varnothing (mm)	Code	THCHT (chamfer)	LF (mm)	THL (mm)	LU (mm)	LS (mm)	DCON (mm)	K (mm)	LK (mm)	NOF	Type	Stock
DIN 371															
M3X0.5	IS02X(6HX)	2.5	2.56	LE3.0GBNEV	5P	56	9	18	34	3.5	2.7	6	3	057	●
M4X0.7	IS02X(6HX)	3.3	3.38	LE4.0IBNEV	5P	63	13	21	38	4.5	3.4	6	3	057	●
M5X0.8	IS02X(6HX)	4.2	4.28	LE5.0KBNEV	5P	70	14	25	39	6	4.9	8	3	057	●
M6X1	IS02X(6HX)	5	5.09	LE6.0MBNEV	5P	80	15	30	45	6	4.9	8	3	057	●
M8X1.25	IS02X(6HX)	6.8	6.85	LE8.0NBNEV	5P	90	19	35	47	8	6.2	9	3	084	●
M10X1.5	IS02X(6HX)	8.5	8.6	LE10.0BNEV	5P	100	23	39	52	10	8	11	3	084	●

M	TCTR (tolerance)	\varnothing (mm)	Hole \varnothing (mm)	Code	THCHT (chamfer)	LF (mm)	THL (mm)	LU (mm)	LS (mm)	DCON (mm)	K (mm)	LK (mm)	NOF	Type	Stock
DIN 376															
M12X1.75	IS02X(6HX)	10.3	10.36	LH012PBNEV	5P	110	26	-	56	9	7	10	3	086	●
M14X2	IS02X(6HX)	12	12.12	LH014QBNEV	5P	110	26	-	56	11	9	12	3	086	●
M16X2	IS02X(6HX)	14	14.12	LH016QBNEV	5P	110	26	-	56	12	9	12	3	086	●
M18X2.5	IS02X(6HX)	15.5	15.63	LH018RBNEV	5P	125	33	-	64	14	11	14	4	086	●
M20X2.5	IS02X(6HX)	17.5	17.63	LH020RBNEV	5P	140	33	-	71	16	12	15	4	086	●

MF	TCTR (tolerance)	\varnothing (mm)	Hole \varnothing (mm)	Code	THCHT (chamfer)	LF (mm)	THL (mm)	LU (mm)	LS (mm)	DCON (mm)	K (mm)	LK (mm)	NOF	Type	Stock
DIN 374															
M8X1	IS02X(6HX)	7	7.09	LN8.0MBNEV	5P	90	19	-	46	6	4.9	8	3	086	●
M10X1.25	IS02X(6HX)	8.8	8.85	LN010NBNEV	5P	100	23	-	51	7	5.5	8	3	086	●
M10X1	IS02X(6HX)	9	9.09	LN010MBNEV	5P	90	19	-	46	7	5.5	8	3	086	●
M12X1.5	IS02X(6HX)	10.5	10.6	LN0120BNEV	5P	100	21	-	51	9	7	10	3	086	●
M12X1.25	IS02X(6HX)	10.8	10.85	LN012NBNEV	5P	100	21	-	51	9	7	10	3	086	●
M14X1.5	IS02X(6HX)	12.5	12.6	LN0140BNEV	5P	100	21	-	51	11	9	12	3	086	●
M16X1.5	IS02X(6HX)	14.5	14.6	LN0160BNEV	5P	100	21	-	51	12	9	12	3	086	●
M18X1.5	IS02X(6HX)	16.5	16.6	LN0180BNEV	5P	110	24	-	56	14	11	14	4	086	●
M20X1.5	IS02X(6HX)	18.5	18.6	LN0200BNEV	5P	125	24	-	64	16	12	15	4	086	●

Intro

SP

SL

DIN

PO

ST

ROLL

CARBIDE

LONG

HAND TAPS

EG (STI)

SPECIAL THREADS, GAUGES

THREAD MILLS

DIES

CENTER DRILLS

Technical info

Intro

AUXSL

MP Multi Purpose Series

X Series Left Spiral Fluted Taps, Coated



SP

SL

DIN



Recommended Tapping Speeds Depending On Materials

ISO	Vc (m/min)	ISO	Vc (m/min)	ISO	Vc (m/min)	ISO	Vc (m/min)
P1	10÷25 ★	M1	10÷15 ★	K2	10÷25 ☆	N1	20÷30 ★
P2	10÷25 ★	M2	10÷15 ★			N2	20÷30 ★
P3	10÷25 ★					N3	15÷25 ☆
P4	10÷25 ★					N4	15÷25 ☆
P7	10÷15 ★						

★ 1st choice ☆ suitable

FEATURES

Multi purpose for through hole application on a wide range of materials. High precision blanks and enhanced geometry allow top performance in term of thread accuracy and tool life.

Left hand helix design improves chip ejection even at higher cutting speed.

Suitable coating improves wear, heat and welding resistance.

This item will be gradually replaced by:

· VUPO page 210

PO

ST

ROLL

CARBIDE

LONG

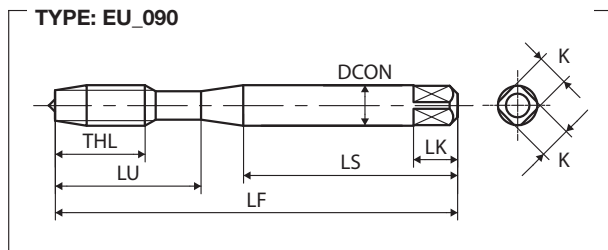

HAND TAPS

M	TCTR (tolerance)	∅ (mm)	Hole ∅ (mm)	Code	THCHT (chamfer)	LF (mm)	THL (mm)	LU (mm)	LS (mm)	DCON (mm)	K (mm)	LK (mm)	NOF	Type	Stock
DIN YMW															
M6X1	ISO2X(6HX)	5	5.09	LX6.0MBNEV	5P	80	15	30	45	6	4.9	8	3	090	▽
M8X1.25	ISO2X(6HX)	6.8	6.85	LX8.0NBNEV	5P	90	19	35	48	8	6.2	9	3	090	▽
M10X1.5	ISO2X(6HX)	8.5	8.6	LX0100BNEV	5P	100	23	39	53	10	8	11	3	090	▽
M12X1.75	ISO2X(6HX)	10.3	10.36	LX012PBNEV	5P	110	26	45	56	12	9	12	3	090	▽

EG (STI)

SPECIAL THREADS, GAUGES

THREAD MILLS

DIES

CENTER DRILLS

Technical info

SL+VA

MS Material Specific Series

Plus Series Left Spiral Fluted Taps for Stainless Steel



Intro

SP

SL
DIN

PO

ST

ROLL

CARBIDE

LONG

HAND
TAPS

EG (STI)

SPECIAL
THREADS,
GAUGES

THREAD
MILLS

DIES

CENTER
DRILLS

Technical
info



FEATURES

Material specific for through hole application.
Most suitable for stainless steel, steel and alloy steel.
OX treatment reduces welding troubles and left hand helix improves chip ejection.

Recommended Tapping Speeds Depending On Materials

ISO	Vc (m/min)	ISO	Vc (m/min)
P1	10÷15 ★	M1	5÷15 ★
P2	10÷15 ★	M2	5÷10 ☆
P3	≤10 ★		
P4	≤10 ☆		
P7	5÷15 ★		

★ 1st choice ☆ suitable

version UP+ Product Features

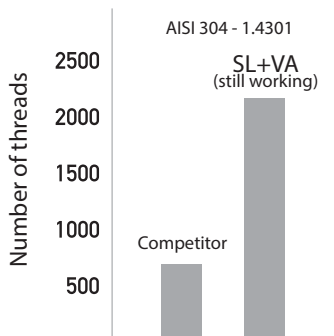

SL+VA 2000 holes



internal thread shape

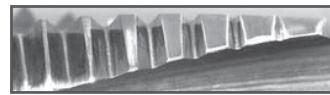

Worn out tap

COMPETITOR

700 holes



internal thread shape



Worn out tap

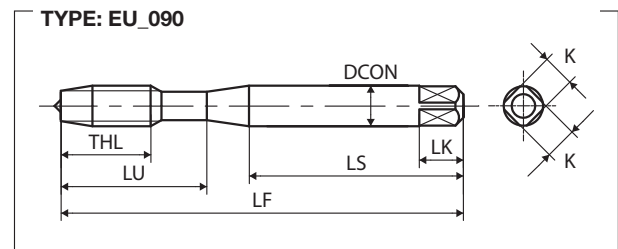
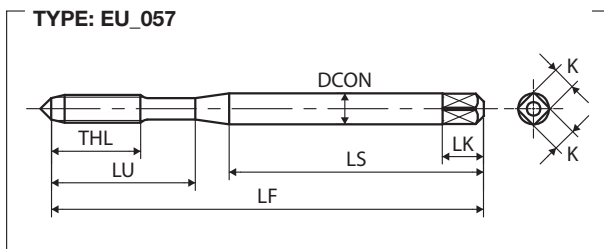

M	TCTR (tolerance)	Hole Ø (mm)	Hole Ø (mm)	Code	THCHT (chamfer)	LF (mm)	THL (mm)	LU (mm)	LS (mm)	DCON (mm)	K (mm)	LK (mm)	NOF	Type	Stock
DIN 371															
M3X0.5	ISO2X(6HX)	2.5	2.56	LE3.0GBGEX	5P	56	9	18	34	3.5	2.7	6	3	057	●
M4X0.7	ISO2X(6HX)	3.3	3.38	LE4.0IBGEX	5P	63	13	21	38	4.5	3.4	6	3	057	●
M5X0.8	ISO2X(6HX)	4.2	4.28	LE5.0KBGEX	5P	70	14	25	39	6	4.9	8	3	057	●
M	TCTR (tolerance)	Hole Ø (mm)	Hole Ø (mm)	Code	THCHT (chamfer)	LF (mm)	THL (mm)	LU (mm)	LS (mm)	DCON (mm)	K (mm)	LK (mm)	NOF	Type	Stock
DIN YMW															
M6X1	ISO2X(6HX)	5	5.09	LZ6.0MBGEX	5P	80	15	30	45	6	4.9	8	3	090	●
M8X1.25	ISO2X(6HX)	6.8	6.85	LZ8.0NBGEX	5P	90	19	35	48	8	6.2	9	3	090	●
M10X1.5	ISO2X(6HX)	8.5	8.6	LZ0100BGEX	5P	100	23	39	53	10	8	11	3	090	●
M12X1.75	ISO2X(6HX)	10.3	10.36	LZ012PBGEX	5P	110	26	45	56	12	9	12	3	090	●

Intro

ZET-P

MS Material Specific Series

Left Spiral Fluted Taps for Titanium Base Alloys

SP

SL

DIN



Recommended Tapping Speeds Depending On Materials

ISO	Vc (m/min)	ISO	Vc (m/min)	ISO	Vc (m/min)	ISO	Vc (m/min)
P4	5÷10 ☆	M3	3÷6 ☆	K2	5÷10 ☆	S1	5÷10 ☆
P5	5÷8 ☆			K3	5÷10 ☆	S2	5÷10 ☆
P6	3÷6 ☆					S3	3÷6 ★
P8	3÷6 ☆					S5	5÷10 ★

★ 1st choice ☆ suitable

PO

ST

ROLL

CARBIDE

LONG

HAND TAPS

EG (STI)

SPECIAL THREADS, GAUGES

THREAD MILLS

DIES

CENTER DRILLS

Technical info



FEATURES

Material specific for through hole application.

Specific design and NI treatment allow high performance on Titanium base alloys. Left Hand spiral allows smooth chip ejection.

Also suitable for high tensile strength steel, high alloy steel and cast iron.

TYPE: EU_057

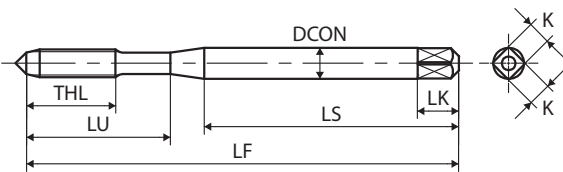

TYPE: EU_084

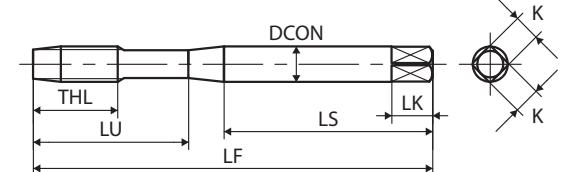

TYPE: EU_086

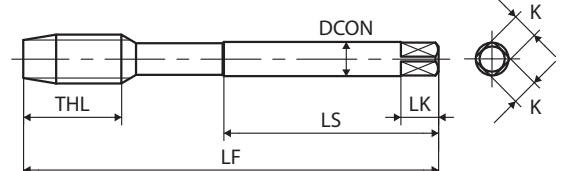

M	TCTR (tolerance)	 Hole Ø (mm)	Hole Ø (mm)	Code	THCHT (chamfer)	LF (mm)	THL (mm)	LU (mm)	LS (mm)	DCON (mm)	K (mm)	LK (mm)	NOF	Type	Stock
DIN 371															
M3X0.5	ISO2X(6HX)	2.5	2.56	LD3.0GBIPN	5P	56	9	18	34	3.5	2.7	6	3	057	●
M4X0.7	ISO2X(6HX)	3.3	3.38	LD4.0IBIPN	5P	63	13	21	38	4.5	3.4	6	3	057	●
M5X0.8	ISO2X(6HX)	4.2	4.28	LD5.0KBIPN	5P	70	14	25	39	6	4.9	8	3	057	●
M6X1	ISO2X(6HX)	5	5.09	LD6.0MBIPN	5P	80	15	30	45	6	4.9	8	3	057	●
M8X1.25	ISO2X(6HX)	6.8	6.85	LD8.0NBIPN	5P	90	19	35	47	8	6.2	9	3	084	●
M10X1.5	ISO2X(6HX)	8.5	8.6	LD0100BIPN	5P	100	23	39	52	10	8	11	3	084	●
DIN 376															
M12X1.75	ISO2X(6HX)	10.3	10.36	LG012PBIPN	5P	110	26	-	56	9	7	10	3	086	●
M14X2	ISO2X(6HX)	12	12.12	LG014QBIPN	5P	110	26	-	56	11	9	12	3	086	●
M16X2	ISO2X(6HX)	14	14.12	LG016QBIPN	5P	110	26	-	56	12	9	12	3	086	●
DIN 374															
M10X1.25	ISO2X(6HX)	8.8	8.85	LM010NBIPN	5P	100	23	-	51	7	5.5	8	3	086	●
M12X1.5	ISO2X(6HX)	10.5	10.6	LM0120BIPN	5P	100	21	-	51	9	7	10	3	086	●
M12X1.25	ISO2X(6HX)	10.8	10.85	LM012NBIPN	5P	100	21	-	51	9	7	10	3	086	●
M14X1.5	ISO2X(6HX)	12.5	12.6	LM0140BIPN	5P	100	21	-	51	11	9	12	3	086	●
M16X1.5	ISO2X(6HX)	14.5	14.6	LM0160BIPN	5P	100	21	-	51	12	9	12	3	086	●

Intro

SP

SL

DIN

PO

ST

ROLL

CARBIDE

LONG

HAND
TAPS

EG (STI)

SPECIAL
THREADS,
GAUGESTHREAD
MILLS

DIES

CENTER
DRILLSTechnical
info

Intro

F-SL

HS High Speed Series

Left Spiral Fluted Taps for High Speed Tapping, Coated



SP

SL

DIN



FEATURES

High Speed for through hole application.

Most suitable for steel, can be used even on stainless steel, cast iron and non-ferrous materials.

For Synchro-rigid tapping system. Left hand spiral allows smooth chip ejection.

PO

ST

ROLL

Recommended Tapping Speeds Depending On Materials

ISO	Vc (m/min)	ISO	Vc (m/min)	ISO	Vc (m/min)	ISO	Vc (m/min)
P1	15÷25 ★	M1	10÷20 ☆	K1	15÷25 ☆	N1	15÷30 ★
P2	15÷25 ★	M2	10÷20 ☆	K2	15÷25 ☆	N2	15÷30 ★
P3	15÷25 ☆					N4	15÷25 ☆
P4	15÷25 ☆						
P7	10÷20 ☆						

★ 1st choice ☆ suitable

This item will be gradually replaced by:

· VUPO page 210

CARBIDE

LONG

HAND TAPS

EG (STI)

SPECIAL THREADS, GAUGES

THREAD MILLS

DIES

CENTER DRILLS

Technical info

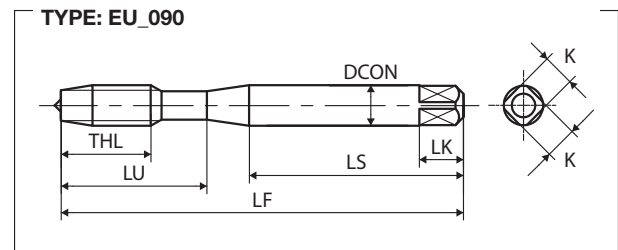
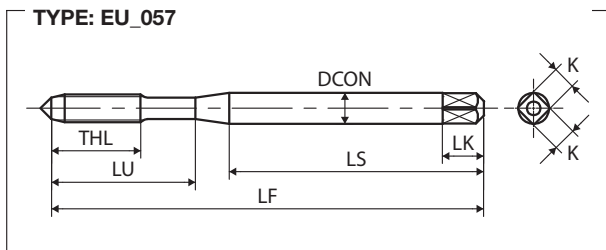

M	TCTR (tolerance)	\varnothing (mm)	Hole \varnothing (mm)	Code	THCHT (chamfer)	LF (mm)	THL (mm)	LU (mm)	LS (mm)	DCON (mm)	K (mm)	LK (mm)	NOF	Type	Stock
DIN 371															
M3X0.5	ISO2X(6HX)	2.5	2.56	LD3.0GBNEV	5P	56	9	18	34	3.5	2.7	6	3	057	▽
M4X0.7	ISO2X(6HX)	3.3	3.38	LD4.0IBNEV	5P	63	13	21	38	4.5	3.4	6	3	057	▽
M5X0.8	ISO2X(6HX)	4.2	4.28	LD5.0KBNEV	5P	70	14	25	39	6	4.9	8	3	057	▽
M	TCTR (tolerance)	\varnothing (mm)	Hole \varnothing (mm)	Code	THCHT (chamfer)	LF (mm)	THL (mm)	LU (mm)	LS (mm)	DCON (mm)	K (mm)	LK (mm)	NOF	Type	Stock
DIN YMW															
M6X1	ISO2X(6HX)	5	5.09	LY6.0MBNEV	5P	80	15	30	45	6	4.9	8	3	090	▽
M8X1.25	ISO2X(6HX)	6.8	6.85	LY8.0NBNEV	5P	90	19	35	48	8	6.2	9	3	090	▽
M10X1.5	ISO2X(6HX)	8.5	8.6	LY0100BNEV	5P	100	23	39	53	10	8	11	3	090	▽
M12X1.75	ISO2X(6HX)	10.3	10.36	LY012PBNEV	5P	110	26	45	56	12	9	12	3	090	▽
MF	TCTR (tolerance)	\varnothing (mm)	Hole \varnothing (mm)	Code	THCHT (chamfer)	LF (mm)	THL (mm)	LU (mm)	LS (mm)	DCON (mm)	K (mm)	LK (mm)	NOF	Type	Stock
DIN YMW															
M10X1.25	ISO2X(6HX)	8.8	8.85	LY010NBNEV	5P	100	19	39	53	10	8	11	3	090	▽
M12X1.5	ISO2X(6HX)	10.5	10.6	LY0120BNEV	5P	110	23	45	56	12	9	12	3	090	▽
M12X1.25	ISO2X(6HX)	10.8	10.85	LY012NBNEV	5P	110	19	45	56	12	9	12	3	090	▽

HDISL

HS High Speed Series

Left Spiral Fluted Taps with Radial Coolant Holes for Ultra High Speed Tapping, Coated



FEATURES

Ultra High Speed with radial coolant holes for through hole application

Most suitable for steel, can be used even on stainless steel, cast iron and non-ferrous materials.

For Synchro-rigid tapping system. Left hand spiral allows smooth chip ejection.

Recommended Tapping Speeds Depending On Materials

ISO	Vc (m/min)	ISO	Vc (m/min)	ISO	Vc (m/min)	ISO	Vc (m/min)
P1	20÷50 ★	M1	15÷30 ☆	K1	20÷40 ★	N1	30÷100 ★
P2	20÷50 ★	M2	15÷25 ☆	K2	20÷40 ★	N2	30÷100 ★
P3	20÷30 ★					N4	30÷60 ☆
P4	20÷30 ★						
P5	15÷25 ☆						
P7	15÷30 ☆						

★ 1st choice ☆ suitable

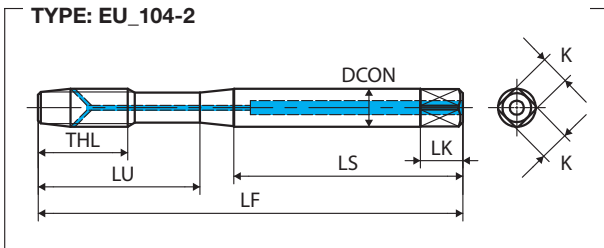

M	TCTR (tolerance)	Hole Ø (mm)	Hole Ø (mm)	Code	THCHT (chamfer)	LF (mm)	THL (mm)	LU (mm)	LS (mm)	DCON (mm)	K (mm)	LK (mm)	NOF	Type	Stock
DIN YMW															
M6X1	ISO2X(6HX)	5	5.09	LY6.0NBEDTLZ	5P	80	15	30	45	6	4.9	8	3	104-2	●
M8X1.25	ISO2X(6HX)	6.8	6.85	LY8.0NBEDTLZ	5P	90	19	35	48	8	6.2	9	3	104-2	●
M10X1.5	ISO2X(6HX)	8.5	8.6	LY0100BEDTLZ	5P	100	23	39	53	10	8	11	3	104-2	●
M12X1.75	ISO2X(6HX)	10.3	10.36	LY012PBEDTLZ	5P	110	26	44	57	12	9	12	3	104-2	●
M14X2	ISO2X(6HX)	12	12.12	TCYLZ004	5P	110	26	-	62	12	9	12	3	104-2	●
M16X2	ISO2X(6HX)	14	14.12	SFYLZ005	5P	110	26	-	58	16	12	15	3	104-2	●
M20X2.5	ISO2X(6HX)	17.5	17.63	UJYLZ004	5P	140	33	-	80	16	12	15	4	104-2	●
DIN YMW															
M10X1.25	ISO2X(6HX)	8.8	8.85	LY010NBEDTLZ	5P	100	23	39	53	10	8	11	3	104-2	●
M12X1.5	ISO2X(6HX)	10.5	10.6	LY0120BEDTLZ	5P	110	26	44	57	12	9	12	3	104-2	●
M12X1.25	ISO2X(6HX)	10.8	10.85	LY012NBEDTLZ	5P	110	26	44	57	12	9	12	3	104-2	●
M14X1.5	ISO2X(6HX)	12.5	12.6	SFYLZ006	5P	110	26	-	62	12	9	12	3	104-2	●
M16X1.5	ISO2X(6HX)	14.5	14.6	UJYLZ003	5P	110	26	-	58	16	12	15	3	104-2	●

- Intro
- SP
- SL
- DIN
- PO
- ST
- ROLL
- CARBIDE
- LONG
- HAND TAPS
- EG (STI)
- SPECIAL THREADS, GAUGES
- THREAD MILLS
- DIES
- CENTER DRILLS
- Technical info

Intro

ZELX TI LHSP

MS Material Specific Series

Left Spiral Fluted Taps for Titanium Base Alloys



SP

SL

ANSI



PO

ST

Recommended Tapping Speeds Depending On Materials

ISO	Vc (m/min)	ISO	Vc (m/min)	ISO	Vc (m/min)	ISO	Vc (m/min)
P4	5÷10 ☆	M3	3÷6 ☆	K2	5÷10 ☆	S1	5÷10 ☆
P5	5÷8 ☆			K3	5÷10 ☆	S2	5÷10 ☆
P6	3÷6 ☆					S3	3÷6 ☆
P8	3÷6 ☆					S5	5÷10 ★

★ 1st choice ☆ suitable

ROLL

CARBIDE

LONG

HAND TAPS

EG (STI)

SPECIAL THREADS, GAUGES

THREAD MILLS

DIES

CENTER DRILLS

Technical info

FEATURES



Material specific for through hole application.

Specific design and NI treatment allow high performance on Titanium base alloys. Left Hand spiral allows smooth chip ejection.

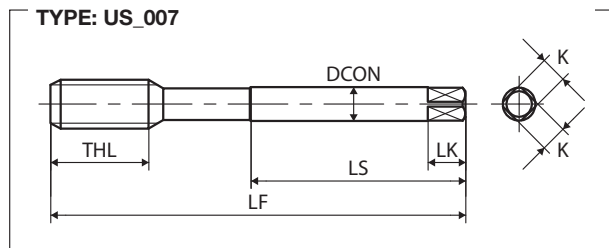
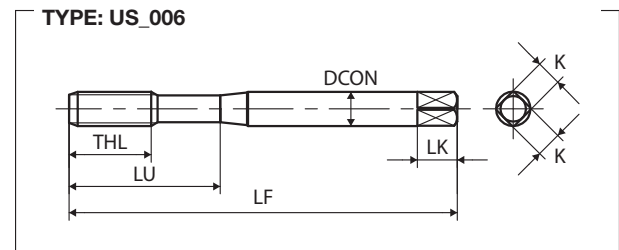
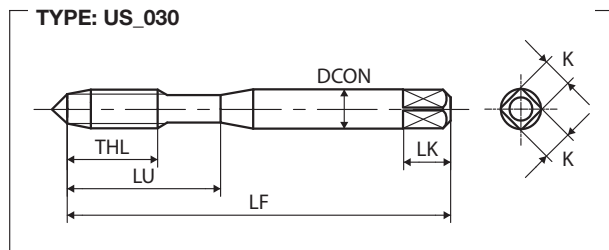
Also suitable for high tensile strength steel, high alloy steel and cast iron.



UNC	TCTR (tolerance)	Hole Ø (mm)	Hole Ø (mm)	Code	THCHT (chamfer)	LF (inch)	THL (inch)	LU (inch)	LS (inch)	DCON (inch)	K (inch)	LK (inch)	NOF	Type	Stock
ANSI															
No.2-56UNC	GH2	1.8	1.83	Y85623	5P	1.75	0.256	0.437	-	0.141	0.11	0.187	3	030	○
No.4-40UNC	GH2	2.3	2.33	Y85601	5P	1.875	0.335	0.562	-	0.141	0.11	0.187	3	030	○
No.5-40UNC	GH2	2.6	2.64	Y85603	5P	1.937	0.374	0.625	-	0.141	0.11	0.187	3	030	○
No.6-32UNC	GH3	2.8	2.83	Y85605	5P	2	0.413	0.687	-	0.141	0.11	0.187	3	030	○
	GH5	2.8	2.83	Y85635	5P	2	0.413	0.687	-	0.141	0.11	0.187	3	030	○
No.8-32UNC	GH3	3.4	3.47	Y85607	5P	2.125	0.453	0.75	-	0.168	0.131	0.25	3	030	○
	GH4	3.4	3.47	Y85629	5P	2.125	0.453	0.75	-	0.168	0.131	0.25	3	030	○
	GH5	3.4	3.47	Y85637	5P	2.125	0.453	0.75	-	0.168	0.131	0.25	3	030	○
	GH6	3.4	3.47	Y85660	5P	2.125	0.453	0.75	-	0.168	0.131	0.25	3	030	○
	GH7	3.4	3.47	Y85667	5P	2.125	0.453	0.75	-	0.168	0.131	0.25	3	030	○

UNC	TCTR (tolerance)	 Hole Ø (mm)	Hole Ø (mm)	Code	THCHT (chamfer)	LF (inch)	THL (inch)	LU (inch)	LS (inch)	DCON (inch)	K (inch)	LK (inch)	NOF	Type	Stock
ANSI															
No.10-24UNC	GH3	3.89	3.9	Y85609	5P	2.375	0.531	0.875	-	0.194	0.152	0.25	3	030	○
	GH5	3.89	3.9	Y85639	5P	2.375	0.531	0.875	-	0.194	0.152	0.25	3	030	○
1/4-20UNC	GH3	5.1	5.19	Y85613	5P	2.5	0.591	1	-	0.255	0.191	0.312	3	006	○
	GH5	5.1	5.19	Y85643	5P	2.5	0.591	1	-	0.255	0.191	0.312	3	006	○
5/16-18UNC	GH3	6.6	6.65	Y85615	5P	2.718	0.669	1.125	-	0.318	0.238	0.375	3	006	○
	GH5	6.6	6.65	Y85645	5P	2.718	0.669	1.125	-	0.318	0.238	0.375	3	006	○
3/8-16UNC	GH3	8	8.07	Y85617	5P	2.937	0.748	1.25	-	0.381	0.286	0.437	3	006	○
	GH5	8	8.07	Y85647	5P	2.937	0.748	1.25	-	0.381	0.286	0.437	3	006	○
7/16-14UNC	GH3	9.4	9.45	Y85619	5P	3.156	0.866	-	-	0.323	0.242	0.406	3	007	○
	GH5	9.4	9.45	Y85649	5P	3.156	0.866	-	-	0.323	0.242	0.406	3	007	○
1/2-13UNC	GH3	10.9	10.91	Y85621	5P	3.375	0.984	-	-	0.367	0.275	0.437	3	007	○
	GH5	10.9	10.91	Y85651	5P	3.375	0.984	-	-	0.367	0.275	0.437	3	007	○
5/8-11UNC	GH3	13.6	13.75	Y85625	5P	3.812	1.083	-	-	0.48	0.36	0.562	3	007	○
3/4-10UNC	GH3	16.6	16.7	Y85627	5P	4.25	1.201	-	-	0.59	0.442	0.687	3	007	○
UNF	TCTR (tolerance)	 Hole Ø (mm)	Hole Ø (mm)	Code	THCHT (chamfer)	LF (inch)	THL (inch)	LU (inch)	LS (inch)	DCON (inch)	K (inch)	LK (inch)	NOF	Type	Stock
ANSI															
No.10-32UNF	GH3	4.1	4.12	Y85610	5P	2.375	0.531	0.875	-	0.194	0.152	0.25	3	030	●
	GH4	4.1	4.12	Y85630	5P	2.375	0.531	0.875	-	0.194	0.152	0.25	3	030	○
	GH5	4.1	4.12	Y85640	5P	2.375	0.531	0.875	-	0.194	0.152	0.25	3	030	○
	GH6	4.1	4.12	Y85661	5P	2.375	0.531	0.875	-	0.194	0.152	0.25	3	030	○
	GH7	4.1	4.12	Y85670	5P	2.375	0.531	0.875	-	0.194	0.152	0.25	3	030	○
1/4-28UNF	GH3	5.5	5.53	Y85614	5P	2.5	0.591	1	-	0.255	0.191	0.312	3	006	●
	GH4	5.5	5.53	Y85631	5P	2.5	0.591	1	-	0.255	0.191	0.312	3	006	○
	GH5	5.5	5.53	Y85644	5P	2.5	0.591	1	-	0.255	0.191	0.312	3	006	○
	GH6	5.5	5.53	Y85662	5P	2.5	0.591	1	-	0.255	0.191	0.312	3	006	○
	GH7	5.5	5.53	Y85674	5P	2.5	0.591	1	-	0.255	0.191	0.312	3	006	○
5/16-24UNF	GH3	6.9	6.97	Y85616	5P	2.718	0.669	1.125	-	0.318	0.238	0.375	3	006	●
	GH4	6.9	6.97	Y85632	5P	2.718	0.669	1.125	-	0.318	0.238	0.375	3	006	○
	GH5	6.9	6.97	Y85646	5P	2.718	0.669	1.125	-	0.318	0.238	0.375	3	006	○
	GH6	6.9	6.97	Y85663	5P	2.718	0.669	1.125	-	0.318	0.238	0.375	3	006	○
	GH7	6.9	6.97	Y85676	5P	2.718	0.669	1.125	-	0.318	0.238	0.375	3	006	○
3/8-24UNF	GH3	8.5	8.57	Y85618	5P	2.937	0.748	1.25	-	0.381	0.286	0.437	3	006	●
	GH4	8.5	8.57	Y85633	5P	2.937	0.748	1.25	-	0.381	0.286	0.437	3	006	○
	GH5	8.5	8.57	Y85648	5P	2.937	0.748	1.25	-	0.381	0.286	0.437	3	006	○
	GH6	8.5	8.57	Y85664	5P	2.937	0.748	1.25	-	0.381	0.286	0.437	3	006	○
	GH7	8.5	8.57	Y85678	5P	2.937	0.748	1.25	-	0.381	0.286	0.437	3	006	○
7/16-20UNF	GH3	9.9	9.96	Y85620	5P	3.156	0.866	-	-	0.323	0.242	0.406	3	007	○
	GH5	9.9	9.96	Y85650	5P	3.156	0.866	-	-	0.323	0.242	0.406	3	007	○
1/2-20UNF	GH3	11.5	11.54	Y85622	5P	3.375	0.984	-	-	0.367	0.275	0.437	3	007	○
	GH5	11.5	11.54	Y85652	5P	3.375	0.984	-	-	0.367	0.275	0.437	3	007	○
5/8-18UNF	GH3	14.5	14.6	Y85626	5P	3.812	1.083	-	-	0.48	0.36	0.562	3	007	○
3/4-16UNF	GH3	17.5	17.59	Y85628	5P	4.25	1.201	-	-	0.59	0.442	0.687	3	007	○

The most suitable GH tap class to cut accurate 2B, 3B (UNJ) and 2B oversized internal threads tolerance, depends on application conditions and work-piece materials. Yamawa GH class system offers a wide range of alternative tap classes allowing each customer to select the most suitable one according to application requirement. Check page 673 of Technical info for full details.

Intro

SP

SL

ANSI

PO

ST

ROLL

CARBIDE

LONG

HAND TAPS

EG (STI)

SPECIAL THREADS, GAUGES

THREAD MILLS

DIES

CENTER DRILLS

Technical info

SPIRAL POINTED TAPS



PO - DIN **210**
PO - JIS **232**
PO - ANSI **246**

Selection Chart

Intro

SP

SL

PO

ST

ROLL

CARBIDE

LONG

HAND TAPS

EG (STI)

SPECIAL THREADS, GAUGES

THREAD MILLS

DIES

CENTER DRILLS

Technical info

	Z-PRO		GP General Purpose							MS Material Specific
	VUPO		PO	PO ISO3(6G)	PO ISO2(6H)+100	PO LH	PO OX	PO V	PM-PO	
	HSS-P	COATING	HSS-E	HSS-E	HSS-E	HSS-E	HSS-E OX	HSS-E COATING	HSS-P	
	DIN	DIN	JIS	ANSI	DIN	DIN	JIS	DIN	DIN	DIN
M	211	213	233		213	213	240	219	221	223
MF	211	214	234				241		221	223
UNC/UNF		215	237	247			241			
UNS, 8, 12, 20, 32UN			238							
UNEF			238							
G (BSP)		216						219	221	
Rp (BSPP)										
Rc (BSPT)										
NPT										
NPTF										
NPSC, NPSM, NPSF										
BSW			239				241			
EG(STI), M, MF, UNC/UNF										
Pg										
Tr										
S miniature										
Special threads										
	Vc (m/min)									
P1	★ 10÷30	☆ 5÷10	☆ 5÷10	☆ 5÷10	☆ 5÷10	☆ 5÷10	☆ 5÷10	★ 5÷10	★ 10÷20	
P2	★ 10÷30	★ 5÷10	★ 5÷10	★ 5÷10	★ 5÷10	★ 5÷10	★ 5÷10	★ 5÷10	★ 10÷20	
P3	★ 10÷30	☆ 5÷10	☆ 5÷10	☆ 5÷10	☆ 5÷10	☆ 5÷10	☆ 5÷10	☆ 5÷10	★ 10÷20	★ 2÷10
P4	★ 10÷25	☆ 5÷8	☆ 5÷8	☆ 5÷8	☆ 5÷8	☆ 5÷8	☆ 5÷8	☆ 5÷8	★ 10÷15	★ 2÷7
P5								☆ 4÷7		★ 2÷7
P6										★ 2÷5
P7	★ 5÷15							☆ 4÷8	☆ 6÷12	
P8										
M1	★ 5÷15							☆ 4÷8	☆ 6÷12	
M2	☆ 5÷10								☆ 5÷10	
M3										
K1	☆ 10÷20									
K2	☆ 10÷20									
K3										
K4										
N1	★ 10÷40	☆ 5÷10	☆ 5÷10	☆ 5÷10	☆ 5÷10	☆ 5÷10	☆ 5÷10		☆ 10÷20	
N2	★ 10÷40	☆ 5÷10	☆ 5÷10	☆ 5÷10	☆ 5÷10	☆ 5÷10	☆ 5÷10		☆ 10÷20	
N3	☆ 10÷25	☆ 5÷10	☆ 5÷10	☆ 5÷10	☆ 5÷10	☆ 5÷10	☆ 5÷10		☆ 10÷20	
N4	☆ 10÷20	☆ 5÷10	☆ 5÷10	☆ 5÷10	☆ 5÷10	☆ 5÷10	☆ 5÷10		☆ 10÷20	
N5										
S1 (<25 HRC)										
S2 (<35 HRC)										
S3 (35 ÷ 45 HRC)										
S5										
H (45 ÷ 55 HRC)										
H (55 ÷ 63 HRC)										

★ 1st choice ☆ suitable

Intro

SP

SL

PO

ST

ROLL

CARBIDE

LONG

HAND TAPS

EG (STI)

SPECIAL THREADS, GAUGES

THREAD MILLS

DIES

CENTER DRILLS

Technical info

MS Material Specific								
EH-PO	PO-VA	SU+PO/SU-PO	ZELX SS PO	PO-VA TiCN	ZELX AL PO	ZEN-P	ZELX NI PO	
HSS-Co	HSS-E OX	HSS-E OX	HSS-E OX	HSS-E COATING	HSS-E NI	HSS-P NX	HSS-P NX	
DIN								
225	227	242	ANSI	229	ANSI	230	ANSI	M
225	227	244				231		MF
	227	244	251		255	231	257	UNC/UNF
								UNS, 8, 12, 20, 32UN
	228							UNEF
								G (BSP)
								Rp (BSPP)
								Rc (BSPT)
								NPT
								NPTF
								NPSC, NPSM, NPSF
		245						BSW
								EG(STI), M, MF, UNC/UNF
								Pg
								Tr
								S miniature
								Special threads
Vc (m/min)								
	★ ≤10	★ ≤10	★ ≤10	★ ≤15				P1
	★ ≤10	★ ≤10	★ ≤10	★ ≤15				P2
	★ ≤10	★ ≤10	★ ≤10	★ ≤10		★ 5÷15	★ 5÷15	P3
	☆ ≤10	☆ ≤10	☆ ≤10	☆ ≤10		★ 5÷15	★ 5÷15	P4
★ ≤5						☆ 5÷10	☆ 5÷10	P5
★ ≤5								P6
	★ ≤10	★ ≤10	★ ≤10	★ ≤10		★ 5÷15	★ 5÷15	P7
						★ 4÷8	★ 4÷8	P8
	★ ≤10	★ ≤10	★ ≤10	★ ≤10		★ 5÷15	★ 5÷15	M1
	☆ ≤10	★ ≤10	★ ≤10	☆ ≤10		★ 5÷15	★ 5÷15	M2
						★ 4÷8	★ 4÷8	M3
								K1
								K2
								K3
								K4
					★ 5÷15			N1
					★ 5÷15			N2
					★ 5÷15			N3
								N4
								N5
						★ 5÷10	★ 5÷10	S1 (<25 HRC)
						★ 5÷10	★ 5÷10	S2 (<35 HRC)
						☆ 3÷6	☆ 3÷6	S3 (35 ÷ 45 HRC)
								S5
								H (45 ÷ 55 HRC)
								H (55 ÷ 63 HRC)

Intro

VUPO

Z-PRO Series

HSSP Spiral Pointed Taps, Coated



SP

SL



PO

DIN

ST

ROLL

Recommended Tapping Speeds Depending On Materials

ISO	Vc (m/min)	ISO	Vc (m/min)	ISO	Vc (m/min)	ISO	Vc (m/min)
P1	10÷30 ★	M1	5÷15 ★	K1	10÷20 ☆	N1	10÷40 ★
P2	10÷30 ★	M2	5÷10 ☆	K2	10÷20 ☆	N2	10÷40 ★
P3	10÷30 ★					N3	10÷25 ☆
P4	10÷25 ★					N4	10÷20 ☆
P7	5÷15 ★						

★ 1st choice ☆ suitable

FEATURES

Longer Life - Great improvement thanks to the new premium grade of powder high speed steel and new special coating.

New Flute Shape - Improved chip ejection, reduced cutting resistance and excellent internal threads finishing thanks to unique flute shape.

For wide range of workpiece materials: steel, alloy steel, stainless steel and aluminium.



WATCH THE VIDEO

CARBIDE

LONG

HAND TAPS

EG (STI)

Product Features

Lubricant	Hole shape	Hand tapping	Drilling machine	Low speed	Middle speed
Emulsion					VUSP
					VUPO Vc ≤ 30 m/min
Oil		HTset	ISP	SP	SP V
		IHT	IPO	PO	PO V
					AU+SP
					AU+SL

SPECIAL THREADS, GAUGES

THREAD MILLS

DIES

CENTER DRILLS

Technical info

Enlarged photo after 560 threads



M10x1.5

Work-material	Ck50 - 1.1213
Thread length	20 mm
Tapping speed	20 m/min
Machine	Vertical machining center
Lubricant	Water soluble oil

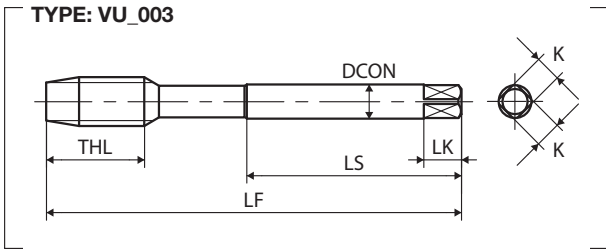
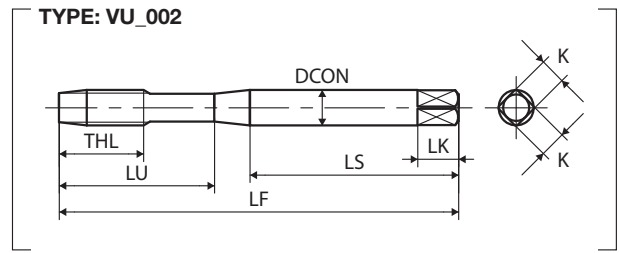
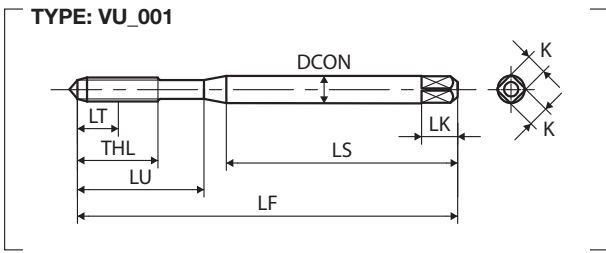

M	TCTR (tolerance)	∅ (mm)	Hole ∅ (mm)	Code	THCHT (chamfer)	LF (mm)	THL (mm)	LU (mm)	LS (mm)	DCON (mm)	K (mm)	LK (mm)	NOF	Type	Stock
DIN 371															
M3X0.5	ISO2X(6HX)	2.5	2.56	3102101035	5P	56	9	18	34	3.5	2.7	6	3	001	●
M4X0.7	ISO2X(6HX)	3.3	3.38	3102101042	5P	63	13	21	38	4.5	3.4	6	3	001	●
M5X0.8	ISO2X(6HX)	4.2	4.28	3102101049	5P	70	14	25	39	6	4.9	8	3	001	●
M6X1	ISO2X(6HX)	5	5.09	3102101055	5P	80	15	30	45	6	4.9	8	3	001	●
M8X1.25	ISO2X(6HX)	6.8	6.85	3102101064	5P	90	19	35	47	8	6.2	9	3	002	●
M10X1.5	ISO2X(6HX)	8.5	8.6	3102101078	5P	100	23	39	52.5	10	8	11	3	002	●
DIN 376															
M12X1.75	ISO2X(6HX)	10.3	10.36	3102101088	5P	110	26	-	56	9	7	10	3	003	●
M14X2	ISO2X(6HX)	12	12.12	3102101100	5P	110	26	-	56	11	9	12	3	003	●
M16X2	ISO2X(6HX)	14	14.12	3102101114	5P	110	26	-	56	12	9	12	3	003	●
DIN 371															
M3X0.35	ISO2X(6HX)	2.65	2.7	3102101036	5P	56	6.5	18	34	3.5	2.7	6	3	001	●
M4X0.5	ISO2X(6HX)	3.5	3.56	3102101043	5P	63	9	21	38	4.5	3.4	6	3	001	●
M5X0.5	ISO2X(6HX)	4.5	4.56	3102101051	5P	70	9	25	39	6	4.9	8	3	001	●
M6X0.75	ISO2X(6HX)	5.25	5.33	3102101056	5P	80	15	30	45	6	4.9	8	3	001	●
M6X0.5	ISO2X(6HX)	5.5	5.56	3102101057	5P	80	9	30	45	6	4.9	8	3	001	●
DIN 374															
M8X1	ISO2X(6HX)	7	7.09	3102101065	5P	90	19	-	46	6	4.9	8	3	003	●
M10X1.25	ISO2X(6HX)	8.8	8.85	3102101079	5P	100	23	-	51	7	5.5	8	3	003	●
M10X1	ISO2X(6HX)	9	9.09	3102101080	5P	90	19	-	46	7	5.5	8	3	003	●
M12X1.5	ISO2X(6HX)	10.5	10.6	3102101089	5P	100	21	-	51	9	7	10	3	003	●
M12X1.25	ISO2X(6HX)	10.8	10.85	3102101090	5P	100	21	-	51	9	7	10	3	003	●
M14X1.5	ISO2X(6HX)	12.5	12.6	3102101102	5P	100	21	-	51	11	9	12	3	003	●
M16X1.5	ISO2X(6HX)	14.5	14.6	3102101116	5P	100	21	-	51	12	9	12	3	003	●

Intro
SP
SL
PO
DIN
ST
ROLL
CARBIDE
LONG
HAND TAPS
EG (STI)
SPECIAL THREADS, GAUGES
THREAD MILLS
DIES
CENTER DRILLS
Technical info

Intro

PO

GP General Purpose Series

SP

Spiral Pointed Taps

SL



PO

Recommended Tapping Speeds Depending On Materials

DIN

ISO	Vc (m/min)	ISO	Vc (m/min)
P1	5÷10 ☆	N1	5÷10 ☆
P2	5÷10 ★	N2	5÷10 ☆
P3	5÷10 ☆	N3	5÷10 ☆
P4	5÷8 ☆	N4	5÷10 ☆

★ 1st choice ☆ suitable

ST

ROLL

CARBIDE

LONG

HAND TAPS

EG (STI)

SPECIAL THREADS, GAUGES

THREAD MILLS

DIES

CENTER DRILLS

Technical info



FEATURES

General purpose for through hole application.

For steel application at medium-low cutting speed, also suitable for non-ferrous materials.

TYPE: EU_001

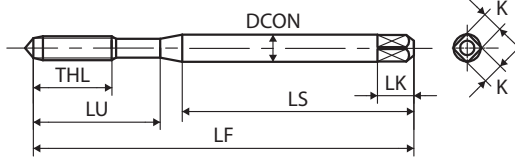

TYPE: EU_057

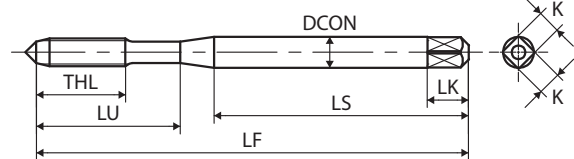

TYPE: EU_083

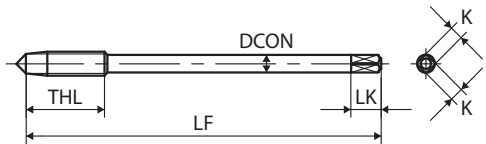

TYPE: EU_084

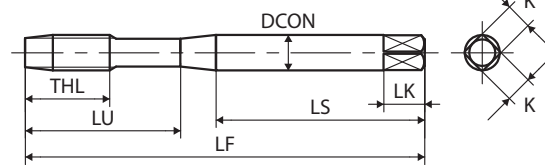

TYPE: EU_086

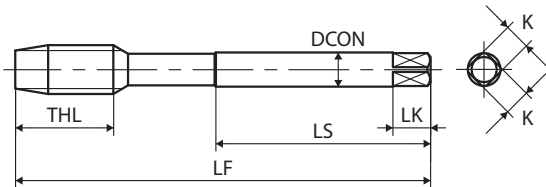

M	TCTR (tolerance)	 Hole Ø (mm)	Hole Ø (mm)	Code	THCHT (chamfer)	LF (mm)	THL (mm)	LU (mm)	LS (mm)	DCON (mm)	K (mm)	LK (mm)	NOF	Type	Stock
DIN 371															
M1.4X0.3	ISO1(4H)	1.1	1.13	96301.4	5P	40	7	-	28	2.5	2.1	5	3	001	●
M1.6X0.35	ISO2(6H)	1.25	1.3	96301.6	5P	40	8	-	28	2.5	2.1	5	3	001	●
M2X0.4	ISO2(6H)	1.6	1.65	PD2.0EANEB	5P	45	8	-	32	2.8	2.1	5	3	001	●
M2.2X0.45	ISO2(6H)	1.75	1.81	PD2.2FANEB	5P	45	9	-	32	2.8	2.1	5	3	001	○
M2.3X0.4	ISO2(6H)	1.9	1.95	PD2.3EANEB	5P	45	9	-	32	2.8	2.1	5	3	001	○
M2.5X0.45	ISO2(6H)	2.1	2.11	PD2.5FANEB	5P	50	8	15	33	2.8	2.1	5	3	057	●
M2.6X0.45	ISO2(6H)	2.2	2.21	PD2.6FANEB	5P	50	8	15	33	2.8	2.1	5	3	057	●
M3X0.5	ISO2(6H)	2.5	2.56	PD3.0GANEB	5P	56	9	18	34	3.5	2.7	6	3	057	●
	ISO3(6G)	2.5	2.56	PD3.0GMNEB	5P	56	9	18	34	3.5	2.7	6	3	057	●
M3.5X0.6	ISO2(6H)	2.9	2.97	PD3.5HANEB	5P	56	11	20	32	4	3	6	3	057	●
	ISO2(6H)	3.3	3.38	PD4.0IANEB	5P	63	13	21	38	4.5	3.4	6	3	057	●
M4X0.7	ISO3(6G)	3.3	3.38	PD4.0IMNEB	5P	63	13	21	38	4.5	3.4	6	3	057	●
	ISO2(6H)+100	3.3	3.38	FFYCZ002	5P	63	13	21	38	4.5	3.4	6	3	057	●
M5X0.8	ISO2(6H)	4.2	4.28	PD5.0KANEB	5P	70	14	25	39	6	4.9	8	3	057	●
	ISO3(6G)	4.2	4.28	PD5.0KMNEB	5P	70	14	25	39	6	4.9	8	3	057	●
	ISO2(6H)+100	4.2	4.28	SKYCZ013	5P	70	14	25	39	6	4.9	8	3	057	●
M6X1	ISO2(6H)	5	5.09	PD6.0MANEB	5P	80	15	30	45	6	4.9	8	3	057	●
	ISO3(6G)	5	5.09	PD6.0MMNEB	5P	80	15	30	45	6	4.9	8	3	057	●
	ISO2(6H)+100	5	5.09	FFYCZ004	5P	80	15	30	45	6	4.9	8	3	057	●
M7X1	ISO2(6H)	6	6.09	PD7.0MANEB	5P	80	15	30	45	7	5.5	8	3	084	●
M8X1.25	ISO2(6H)	6.8	6.85	PD8.0ANEB	5P	90	19	35	47	8	6.2	9	3	084	●
	ISO3(6G)	6.8	6.85	PD8.0NMNEB	5P	90	19	35	47	8	6.2	9	3	084	●
	ISO2(6H)+100	6.8	6.85	FFYCZ005	5P	90	19	35	47	8	6.2	9	3	084	●
M9X1.25	ISO2(6H)	7.8	7.85	PD9.0ANEB	5P	90	19	35	48	9	7	10	3	084	●
M10X1.5	ISO2(6H)	8.5	8.6	PD0100ANEB	5P	100	23	39	52	10	8	11	3	084	●
	ISO3(6G)	8.5	8.6	PD0100MNEB	5P	100	23	39	52	10	8	11	3	084	●
	ISO2(6H)+100	8.5	8.6	FEYCZ002	5P	100	23	39	52	10	8	11	3	084	●
DIN 376															
M4X0.7	ISO2(6H)	3.3	3.38	PG4.0IANEB	5P	63	13	-	-	2.8	2.1	5	3	083	●
M5X0.8	ISO2(6H)	4.2	4.28	PG5.0KANEB	5P	70	14	-	-	3.5	2.7	6	3	083	●
M6X1	ISO2(6H)	5	5.09	PG6.0MANEB	5P	80	15	-	-	4.5	3.4	6	3	083	●
M8X1.25	ISO2(6H)	6.8	6.85	PG8.0ANEB	5P	90	19	-	46	6	4.9	8	3	086	●
M10X1.5	ISO2(6H)	8.5	8.6	PG0100ANEB	5P	100	23	-	51	7	5.5	8	3	086	●
M11X1.5	ISO2(6H)	9.5	9.6	PG0110ANEB	5P	100	23	-	51	8	6.2	9	3	086	●
M12X1.75	ISO2(6H)	10.3	10.36	PG012PANEB	5P	110	26	-	56	9	7	10	3	086	●
	ISO3(6G)	10.3	10.36	PG012PMNEB	5P	110	26	-	56	9	7	10	3	086	●
M14X2	ISO2(6H)	12	12.12	PG014QANEB	5P	110	26	-	56	11	9	12	3	086	●
	ISO3(6G)	12	12.12	PG014QMNEB	5P	110	26	-	56	11	9	12	3	086	○
M16X2	ISO2(6H)	14	14.12	PG016QANEB	5P	110	26	-	56	12	9	12	3	086	●
	ISO3(6G)	14	14.12	PG016QMNEB	5P	110	26	-	56	12	9	12	3	086	○
M18X2.5	ISO2(6H)	15.5	15.63	PG018RANEB	5P	125	33	-	64	14	11	14	3	086	●
M20X2.5	ISO2(6H)	17.5	17.63	PG020RANEB	5P	140	33	-	71	16	12	15	3	086	●
M22X2.5	ISO2(6H)	19.5	19.63	PG022RANEB	5P	140	33	-	71	18	14.5	17	3	086	●
M24X3	ISO2(6H)	21	21.13	PG024SANEB	5P	160	37	-	82	18	14.5	17	3	086	●
M27X3	ISO2(6H)	24	24.13	PG027SANEB	5P	160	37	-	82	20	16	19	4	086	●

Intro

SP

SL

PO

DIN

ST

ROLL

CARBIDE

LONG

HAND
TAPS



EG (STI)

SPECIAL
THREADS,
GAUGESTHREAD
MILLS

DIES

CENTER
DRILLSTechnical
info

Spiral Pointed Taps

Intro	M	TCTR (tolerance)	 Hole Ø (mm)	Hole Ø (mm)	Code	THCHT (chamfer)	LF (mm)	THL (mm)	LU (mm)	LS (mm)	DCON (mm)	K (mm)	LK (mm)	NOF	Type	Stock
DIN 376																
SP	M30X3.5	ISO2(6H)	26.5	26.63	PG030TANEB	5P	180	44	-	92	22	18	21	4	086	●
	M33X3.5	ISO2(6H)	29.5	29.63	PG033TANEB	5P	180	46	-	92	25	20	23	4	086	●
	M36X4	ISO2(6H)	32	32.12	PG036UANEB	5P	200	52	-	102	28	22	25	4	086	●
SL	M39X4	ISO2(6H)	35	35.12	PG039UANEB	5P	200	52	-	102	32	24	27	4	086	○
	M42X4.5	ISO2(6H)	37.5	37.63	PG042VANEB	5P	200	59	-	102	32	24	27	4	086	○
	M45X4.5	ISO2(6H)	40.5	40.63	PG045VANEB	5P	220	59	-	112	36	29	32	4	086	○
	M48X5	ISO2(6H)	43	43.12	PG048WANEB	5P	250	65	-	128	36	29	32	4	086	○
PO	MF	TCTR (tolerance)	 Hole Ø (mm)	Hole Ø (mm)	Code	THCHT (chamfer)	LF (mm)	THL (mm)	LU (mm)	LS (mm)	DCON (mm)	K (mm)	LK (mm)	NOF	Type	Stock
	DIN 374															
DIN	M4X0.5	ISO2(6H)	3.5	3.56	PM4.0GANEB	5P	63	9	-	-	2.8	2.1	5	3	083	●
ST	M5X0.5	ISO2(6H)	4.5	4.56	PM5.0GANEB	5P	70	11	-	-	3.5	2.7	6	3	083	●
	M6X0.75	ISO2(6H)	5.3	5.33	PM6.0JANEB	5P	80	13	-	-	4.5	3.4	6	3	083	●
	M6X0.5	ISO2(6H)	5.5	5.56	PM6.0GANEB	5P	80	13	-	-	4.5	3.4	6	3	083	●
ROLL	M7X0.75	ISO2(6H)	6.3	6.33	PM7.0JANEB	5P	80	13	-	41	5.5	4.3	7	3	086	○
	M7X0.5	ISO2(6H)	6.5	6.56	PM7.0GANEB	5P	80	13	-	41	5.5	4.3	7	3	086	○
	M8X1	ISO2(6H)	7	7.09	PM8.0MANEB	5P	90	19	-	46	6	4.9	8	3	086	●
CARBIDE	M8X0.75	ISO2(6H)	7.3	7.33	PM8.0JANEB	5P	80	19	-	41	6	4.9	8	3	086	●
	M8X0.5	ISO2(6H)	7.5	7.56	PM8.0GANEB	5P	80	19	-	41	6	4.9	8	3	086	○
	M9X1	ISO2(6H)	8	8.09	PM9.0MANEB	5P	90	19	-	46	7	5.5	8	3	086	○
LONG	M10X1.25	ISO2(6H)	8.8	8.85	PM010NANEB	5P	100	23	-	51	7	5.5	8	3	086	●
	M10X1	ISO2(6H)	9	9.09	PM010MANEB	5P	90	19	-	46	7	5.5	8	3	086	●
	M10X0.75	ISO2(6H)	9.3	9.33	PM010JANEB	5P	90	19	-	46	7	5.5	8	3	086	●
HAND TAPS	M12X1.5	ISO2(6H)	10.5	10.6	PM012OANEB	5P	100	21	-	51	9	7	10	3	086	●
	M12X1.25	ISO2(6H)	10.8	10.85	PM012NANEB	5P	100	21	-	51	9	7	10	3	086	●
	M12X1	ISO2(6H)	11	11.09	PM012MANEB	5P	100	21	-	51	9	7	10	3	086	●
EG (STI)	M14X1.5	ISO2(6H)	12.5	12.6	PM014OANEB	5P	100	21	-	51	11	9	12	3	086	●
	M14X1.25	ISO2(6H)	12.8	12.85	PM014NANEB	5P	100	21	-	51	11	9	12	3	086	●
	M14X1	ISO2(6H)	13	13.09	PM014MANEB	5P	100	21	-	51	11	9	12	3	086	●
SPECIAL THREADS, GAUGES	M16X1.5	ISO2(6H)	14.5	14.6	PM016OANEB	5P	100	21	-	51	12	9	12	3	086	●
	M16X1	ISO2(6H)	15	15.09	PM016MANEB	5P	100	21	-	51	12	9	12	3	086	●
	M18X2	ISO2(6H)	16	16.12	PM018QANEB	5P	125	33	-	64	14	11	14	3	086	●
THREAD MILLS	M18X1.5	ISO2(6H)	16.5	16.6	PM018OANEB	5P	110	24	-	56	14	11	14	3	086	●
	M18X1	ISO2(6H)	17	17.09	PM018MANEB	5P	110	24	-	56	14	11	14	3	086	●
	M20X2	ISO2(6H)	18	18.12	PM020QANEB	5P	140	33	-	71	16	12	15	3	086	●
DIES	M20X1.5	ISO2(6H)	18.5	18.6	PM020OANEB	5P	125	24	-	64	16	12	15	3	086	●
	M20X1	ISO2(6H)	19	19.09	PM020MANEB	5P	125	24	-	64	16	12	15	3	086	●
	M22X2	ISO2(6H)	20	20.12	PM022QANEB	5P	140	33	-	71	18	14.5	17	3	086	●
CENTER DRILLS	M22X1.5	ISO2(6H)	20.5	20.6	PM022OANEB	5P	125	24	-	64	18	14.5	17	3	086	●
	M22X1	ISO2(6H)	21	21.09	PM022MANEB	5P	125	24	-	64	18	14.5	17	3	086	●
	M24X2	ISO2(6H)	22	22.12	PM024QANEB	5P	140	27	-	71	18	14.5	17	3	086	●
TECHNICAL INFO	M24X1.5	ISO2(6H)	22.5	22.6	PM024OANEB	5P	140	27	-	71	18	14.5	17	3	086	●
	M24X1	ISO2(6H)	23	23.09	PM024MANEB	5P	140	27	-	71	18	14.5	17	3	086	●
	M25X1.5	ISO2(6H)	23.5	23.6	PM025OANEB	5P	140	27	-	71	18	14.5	17	3	086	●
TECHNICAL INFO	M26X1.5	ISO2(6H)	24.5	24.6	PM026OANEB	5P	140	27	-	71	18	14.5	17	4	086	●
	M27X2	ISO2(6H)	25	25.12	PM027QANEB	5P	140	27	-	71	20	16	19	4	086	●
	M27X1.5	ISO2(6H)	25.5	25.6	PM027OANEB	5P	140	27	-	71	20	16	19	4	086	●

Technical info

MF	TCTR (tolerance)	 Hole Ø (mm)	Hole Ø (mm)	Code	THCHT (chamfer)	LF (mm)	THL (mm)	LU (mm)	LS (mm)	DCON (mm)	K (mm)	LK (mm)	NOF	Type	Stock
DIN 374															
M27X1	IS02(6H)	26	26.09	PM027MANEB	5P	140	27	-	71	20	16	19	4	086	○
M28X2	IS02(6H)	26	26.12	PM028QANEB	5P	140	27	-	71	20	16	19	4	086	●
M28X1.5	IS02(6H)	26.5	26.6	PM028OANEB	5P	140	27	-	71	20	16	19	4	086	●
M28X1	IS02(6H)	27	27.09	PM028MANEB	5P	140	27	-	71	20	16	19	4	086	○
M30X2	IS02(6H)	28	28.12	PM030QANEB	5P	150	27	-	77	22	18	21	4	086	●
M30X1.5	IS02(6H)	28.5	28.6	PM030OANEB	5P	150	27	-	77	22	18	21	4	086	●
M30X1	IS02(6H)	29	29.09	PM030MANEB	5P	150	27	-	77	22	18	21	4	086	●
M32X2	IS02(6H)	30	30.12	PM032QANEB	5P	150	27	-	77	22	18	21	4	086	●
M32X1.5	IS02(6H)	30.5	30.6	PM032OANEB	5P	150	27	-	77	22	18	21	4	086	●
M32X1	IS02(6H)	31	31.09	PM032MANEB	5P	150	27	-	77	22	18	21	4	086	○
M33X2	IS02(6H)	31	31.12	PM033QANEB	5P	160	29	-	82	25	20	23	4	086	●
M33X1.5	IS02(6H)	31.5	31.6	PM033OANEB	5P	160	29	-	82	25	20	23	4	086	●
M33X1	IS02(6H)	32	32.09	PM033MANEB	5P	160	29	-	82	25	20	23	4	086	○
M36X3	IS02(6H)	33	33.13	PM036SANEB	5P	200	52	-	102	28	22	25	4	086	●
M36X2	IS02(6H)	34	34.12	PM036QANEB	5P	170	29	-	87	28	22	25	4	086	●
M36X1.5	IS02(6H)	34.5	34.6	PM036OANEB	5P	170	29	-	87	28	22	25	4	086	●
M36X1	IS02(6H)	35	35.09	PM036MANEB	5P	170	29	-	87	28	22	25	4	086	○

UNC	TCTR (tolerance)	 Hole Ø (mm)	Hole Ø (mm)	Code	THCHT (chamfer)	LF (mm)	THL (mm)	LU (mm)	LS (mm)	DCON (mm)	K (mm)	LK (mm)	NOF	Type	Stock
DIN 371															
No.4-40UNC	2B	2.3	2.33	PDUN4HXNEB	5P	56	9	18	34	3.5	2.7	6	3	057	●
No.5-40UNC	2B	2.6	2.64	PDUN5HXNEB	5P	56	11	18	34	3.5	2.7	6	3	057	○
No.6-32UNC	2B	2.8	2.83	PDUN6JXNEB	5P	56	11	19	32	4	3	6	3	057	●
No.8-32UNC	2B	3.4	3.47	PDUN8JXNEB	5P	63	13	21	38	4.5	3.4	6	3	057	●
No.10-24UNC	2B	3.89	3.9	PDUNAMXNEB	5P	70	14	24	39	6	4.9	8	3	057	○
No.12-24UNC	2B	4.5	4.53	PDUNCMXNEB	5P	80	15	28	45	6	4.9	8	3	057	○
1/4-20UNC	2B	5.1	5.19	PDU04NXNEB	5P	80	15	30	42	7	5.5	8	3	057	●
5/16-18UNC	2B	6.6	6.65	PDU050XNEB	5P	90	19	35	47	8	6.2	9	3	084	●
3/8-16UNC	2B	8	8.07	PDU06PXNEB	5P	100	23	39	52	9	7	10	3	084	●

UNC	TCTR (tolerance)	 Hole Ø (mm)	Hole Ø (mm)	Code	THCHT (chamfer)	LF (mm)	THL (mm)	LU (mm)	LS (mm)	DCON (mm)	K (mm)	LK (mm)	NOF	Type	Stock
DIN 376															
7/16-14UNC	2B	9.4	9.45	PGU07QXNEB	5P	100	23	-	51	8	6.2	9	3	086	○
1/2-13UNC	2B	10.9	10.91	PGU08RXNEB	5P	110	26	-	56	9	7	10	3	086	●
9/16-12UNC	2B	12.2	12.33	PGU09SXNEB	5P	110	26	-	56	11	9	12	3	086	○
5/8-11UNC	2B	13.6	13.75	PGU10UXNEB	5P	110	26	-	56	12	9	12	3	086	●
3/4-10UNC	2B	16.6	16.7	PGU12VXNEB	5P	125	33	-	64	14	11	14	3	086	●
7/8-9UNC	2B	19.6	19.61	PGU14WXNEB	5P	140	33	-	71	18	14.5	17	3	086	○
1-8UNC	2B	22.3	22.45	PGU16XXNEB	5P	160	37	-	82	18	14.5	17	3	086	●
1 1/8-7UNC	2B	25	25.17	PGU18YXNEB	5P	180	44	-	92	22	18	21	4	086	○
1 1/4-7UNC	2B	28.2	28.35	PGU20YXNEB	5P	180	44	-	92	22	18	21	4	086	○
1 3/8-6UNC	2B	30.8	30.92	PGU22ZXNEB	5P	200	52	-	102	28	20	23	4	086	○
1 1/2-6UNC	2B	34	34.1	PGU24ZXNEB	5P	200	52	-	102	32	24	27	4	086	○
1 3/4-5UNC	2B	39.5	39.61	PGU287XNEB	5P	220	66	-	112	36	29	32	4	086	○

Intro

SP

SL

PO

DIN

ST

ROLL

CARBIDE

LONG

HAND TAPS

EG (STI)

SPECIAL THREADS, GAUGES

THREAD MILLS

DIES

CENTER DRILLS

Technical info

Spiral Pointed Taps

Intro

	UNF	TCTR (tolerance)	 Hole Ø (mm)	Hole Ø (mm)	Code	THCHT (chamfer)	LF (mm)	THL (mm)	LU (mm)	LS (mm)	DCON (mm)	K (mm)	LK (mm)	NOF	Type	Stock
	DIN 371															
SP	No.4-48UNF	2B	2.4	2.41	PDUN4FXNEB	5P	56	9	18	34	3.5	2.7	6	3	057	○
	No.5-44UNF	2B	2.7	2.69	PDUN5GXNEB	5P	56	11	18	34	3.5	2.7	6	3	057	○
	No.6-40UNF	2B	2.9	2.97	PDUN6HXNEB	5P	56	11	19	32	4	3	6	3	057	○
SL	No.8-36UNF	2B	3.5	3.55	PDUN8IXNEB	5P	63	13	21	38	4.5	3.4	6	3	057	○
	No.10-32UNF	2B	4.1	4.12	PDUNAJXNEB	5P	70	14	24	39	6	4.9	8	3	057	●
	No.12-28UNF	2B	4.6	4.67	PDUNCKXNEB	5P	80	15	28	45	6	4.9	8	3	057	○
	1/4-28UNF	2B	5.5	5.53	PDU04KXNEB	5P	80	15	30	42	7	5.5	8	3	057	●

PO

	UNF	TCTR (tolerance)	 Hole Ø (mm)	Hole Ø (mm)	Code	THCHT (chamfer)	LF (mm)	THL (mm)	LU (mm)	LS (mm)	DCON (mm)	K (mm)	LK (mm)	NOF	Type	Stock
	DIN 374															
DIN	5/16-24UNF	2B	6.9	6.97	PMU05MXNEB	5P	90	19	-	46	6	4.9	8	3	086	●
	3/8-24UNF	2B	8.5	8.57	PMU06MXNEB	5P	100	23	-	51	7	5.5	8	3	086	●
ST	7/16-20UNF	2B	9.9	9.96	PMU07NXNEB	5P	100	23	-	51	8	6.2	9	3	086	●
	1/2-20UNF	2B	11.5	11.54	PMU08NXNEB	5P	100	21	-	51	9	7	10	3	086	○
	9/16-18UNF	2B	12.9	13	PMU09OXNEB	5P	100	21	-	51	11	9	12	3	086	●
ROLL	5/8-18UNF	2B	14.5	14.6	PMU100XNEB	5P	100	21	-	51	12	9	12	3	086	●
	3/4-16UNF	2B	17.5	17.59	PMU12PXNEB	5P	110	24	-	56	14	11	14	3	086	●
	7/8-14UNF	2B	20.5	20.57	PMU14QXNEB	5P	125	24	-	64	18	14.5	17	3	086	●
	1-12UNF	2B	23.3	23.46	PMU16SXNEB	5P	140	27	-	71	18	14.5	17	3	086	●
CARBIDE	1 1/8-12UNF	2B	26.5	26.63	PMU18SXNEB	5P	150	27	-	77	22	18	21	4	086	○
	1 1/4-12UNF	2B	29.6	29.81	PMU20SXNEB	5P	150	27	-	77	22	18	21	4	086	○
	1 3/8-12UNF	2B	32.8	32.98	PMU22SXNEB	5P	170	29	-	87	28	20	23	4	086	○
	1 1/2-12UNF	2B	36	36.16	PMU24SXNEB	5P	170	29	-	87	32	24	27	4	086	○

LONG

	G(BSP)	TCTR (tolerance)	 Hole Ø (mm)	Hole Ø (mm)	Code	THCHT (chamfer)	Basic major Ø (mm)	LF (mm)	THL (mm)	LS (mm)	DCON (mm)	K (mm)	LK (mm)	NOF	Type	Stock
	DIN 5156															
HAND TAPS	1/16-28	-	6.75	6.77	PVG0010NEB	5P	7723	90	19	46	6	4.9	8	3	086	○
	1/8-28	-	8.75	8.78	PVG0020NEB	5P	9.728	90	19	46	7	5.5	8	3	086	●
	1/4-19	-	11.75	11.78	PVG0040NEB	5P	13.157	100	21	51	11	9	12	3	086	●
	3/8-19	-	15.25	15.28	PVG0060NEB	5P	16.662	100	21	51	12	9	12	3	086	●
EG (STI)	1/2-14	-	19	19.04	PVG0080NEB	5P	20.955	125	24	64	16	12	15	3	086	●
	5/8-14	-	21	21	PVG0100NEB	5P	22911	125	24	64	18	14.5	17	3	086	○
	3/4-14	-	24.5	24.52	PVG0120NEB	5P	26.441	140	27	71	20	16	19	4	086	●
SPECIAL THREADS, GAUGES	7/8-14	-	28.25	28.28	PVG0140NEB	5P	30201	150	27	77	22	18	21	4	086	○
	1-11	-	30.75	30.77	PVG0160NEB	5P	33.249	160	29	82	25	20	23	4	086	●
	1 1/8-11	-	35.3	35.42	PVG0180NEB	5P	37897	170	29	87	28	22	25	4	086	○
	1 1/4-11	-	39.3	39.43	PVG0200NEB	5P	41.910	170	29	87	32	24	27	4	086	●
THREAD MILLS	1 1/2-11	-	45.25	45.33	PVG0240NEB	5P	47.803	190	31	97	36	29	32	4	086	●

DIES

CENTER
DRILLS

Technical
info

Intro

SP

SL

PO

DIN

ST

ROLL

CARBIDE

LONG

HAND
TAPS

EG (STI)

SPECIAL
THREADS,
GAUGES

THREAD
MILLS

DIES

CENTER
DRILLS

Technical
info

Intro

PO OX

GP General Purpose Series

Spiral Pointed Taps, Oxidized



SP

SL



PO

Recommended Tapping Speeds Depending On Materials

ISO	Vc (m/min)	ISO	Vc (m/min)
P1	5÷10 ★	M1	4÷8 ☆
P2	5÷10 ★		
P3	5÷10 ☆		
P4	5÷8 ☆		
P5	4÷7 ☆		
P7	4÷8 ☆		

★ 1st choice ☆ suitable

DIN

ST

ROLL

CARBIDE

LONG

HAND TAPS

EG (STI)

SPECIAL THREADS, GAUGES

THREAD MILLS

DIES

CENTER DRILLS

Technical info

FEATURES

General purpose for through hole application.

For steel application at medium-low cutting speed, also suitable for stainless steel.

This item will be gradually replaced by:

- PO page 212
- PO-VA page 226

TYPE: EU_057

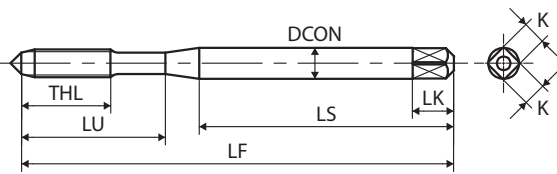

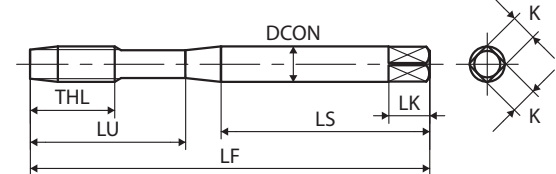

TYPE: EU_084

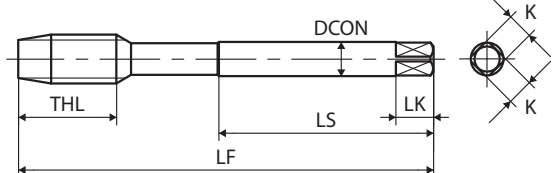

TYPE: EU_086



M	TCTR (tolerance)	 Hole Ø (mm)	Hole Ø (mm)	Code	THCHT (chamfer)	LF (mm)	THL (mm)	LU (mm)	LS (mm)	DCON (mm)	K (mm)	LK (mm)	NOF	Type	Stock
DIN 371															
M3X0.5	ISO2(6H)	2.5	2.56	PD3.0GANEX	5P	56	9	18	34	3.5	2.7	6	3	057	▽
M4X0.7	ISO2(6H)	3.3	3.38	PD4.0IANEX	5P	63	13	21	38	4.5	3.4	6	3	057	▽
M5X0.8	ISO2(6H)	4.2	4.28	PD5.0KANEX	5P	70	14	25	39	6	4.9	8	3	057	▽
M6X1	ISO2(6H)	5	5.09	PD6.0MANEX	5P	80	15	30	45	6	4.9	8	3	057	▽
M8X1.25	ISO2(6H)	6.8	6.85	PD8.0NANEX	5P	90	19	35	47	8	6.2	9	3	084	▽
M10X1.5	ISO2(6H)	8.5	8.6	PD0100ANEX	5P	100	23	39	52	10	8	11	3	084	▽
M	TCTR (tolerance)	 Hole Ø (mm)	Hole Ø (mm)	Code	THCHT (chamfer)	LF (mm)	THL (mm)	LU (mm)	LS (mm)	DCON (mm)	K (mm)	LK (mm)	NOF	Type	Stock
DIN 376															
M12X1.75	ISO2(6H)	10.3	10.36	PG012PANEX	5P	110	26	-	56	9	7	10	3	086	▽
M14X2	ISO2(6H)	12	12.12	PG014QANEX	5P	110	26	-	56	11	9	12	3	086	▽
M16X2	ISO2(6H)	14	14.12	PG016QANEX	5P	110	26	-	56	12	9	12	3	086	▽
M18X2.5	ISO2(6H)	15.5	15.63	PG018RANEX	5P	125	33	-	64	14	11	14	3	086	▽
M20X2.5	ISO2(6H)	17.5	17.63	PG020RANEX	5P	140	33	-	71	16	12	15	3	086	▽
G(BSP)	TCTR (tolerance)	 Hole Ø (mm)	Hole Ø (mm)	Code	THCHT (chamfer)	Basic major Ø (mm)	LF (mm)	THL (mm)	LS (mm)	DCON (mm)	K (mm)	LK (mm)	NOF	Type	Stock
DIN 5156															
1/8-28	-	8.75	8.78	PVG0020NEX	5P	9.728	90	19	46	7	5.5	8	3	086	▽
1/4-19	-	11.75	11.78	PVG0040NEX	5P	13.157	100	21	51	11	9	12	3	086	▽
3/8-19	-	15.25	15.28	PVG0060NEX	5P	16.662	100	21	51	12	9	12	3	086	▽
1/2-14	-	19	19.04	PVG0080NEX	5P	20.955	125	24	64	16	12	15	3	086	▽
3/4-14	-	24.5	24.52	PVG0120NEX	5P	26.441	140	27	71	20	16	19	4	086	▽
1 -11	-	30.75	30.77	PVG0160NEX	5P	33.249	160	29	82	25	20	23	4	086	▽

Intro

SP

SL

PO

DIN

ST

ROLL

CARBIDE

LONG

HAND
TAPS

EG (STI)

SPECIAL
THREADS,
GAUGESTHREAD
MILLS

DIES

CENTER
DRILLSTechnical
info

Intro

PO V

GP General Purpose Series

Spiral Pointed Taps, Coated



SP

SL



FEATURES

General purpose for through hole application.
For tapping steel, also suitable for stainless steel and non-ferrous materials.

PO

Recommended Tapping Speeds Depending On Materials

ISO	Vc (m/min)	ISO	Vc (m/min)	ISO	Vc (m/min)
P1	10÷20 ★	M1	6÷12 ☆	N1	10÷20 ☆
P2	10÷20 ★	M2	5÷10 ☆	N2	10÷20 ☆
P3	10÷20 ★			N3	10÷20 ☆
P4	10÷15 ★			N4	10÷20 ☆
P7	6÷12 ☆				

★ 1st choice ☆ suitable

ROLL

CARBIDE

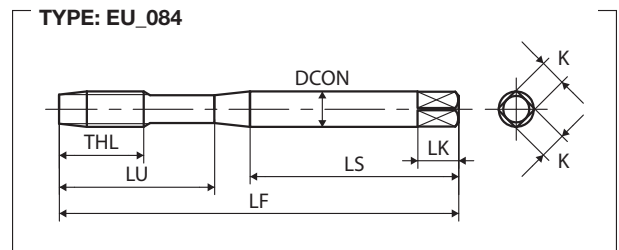
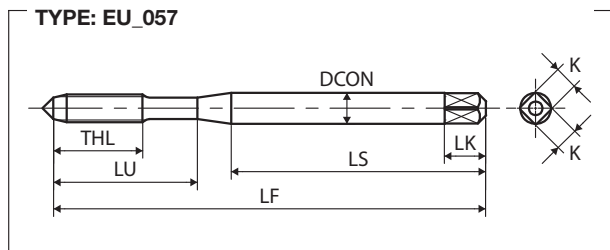

LONG

HAND TAPS

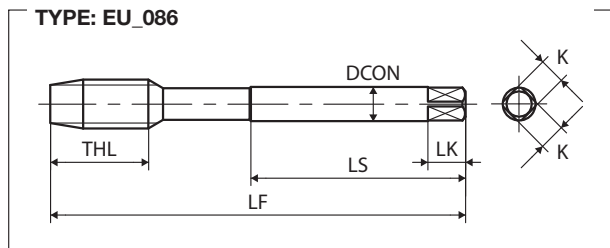

EG (STI)

SPECIAL THREADS, GAUGES

THREAD MILLS

DIES

CENTER DRILLS

Technical info

M	TCTR (tolerance)	 Hole Ø (mm)	Hole Ø (mm)	Code	THCHT (chamfer)	LF (mm)	THL (mm)	LU (mm)	LS (mm)	DCON (mm)	K (mm)	LK (mm)	NOF	Type	Stock
DIN 371															
M3X0.5	ISO2(6H)	2.5	2.56	96303.0TI	5P	56	9	18	34	3.5	2.7	6	3	057	●
M4X0.7	ISO2(6H)	3.3	3.38	96304.0TI	5P	63	13	21	38	4.5	3.4	6	3	057	●
M5X0.8	ISO2(6H)	4.2	4.28	96305.0TI	5P	70	14	25	39	6	4.9	8	3	057	●
M6X1	ISO2(6H)	5	5.09	96306.0TI	5P	80	15	30	45	6	4.9	8	3	057	●
M8X1.25	ISO2(6H)	6.8	6.85	96308.0TI	5P	90	19	35	47	8	6.2	9	3	084	●
M10X1.5	ISO2(6H)	8.5	8.6	9630010TI	5P	100	23	39	52	10	8	11	3	084	●
DIN 376															
M12X1.75	ISO2(6H)	10.3	10.36	9730012TI	5P	110	26	-	56	9	7	10	3	086	●
M14X2	ISO2(6H)	12	12.12	9730014TI	5P	110	26	-	56	11	9	12	3	086	●
M16X2	ISO2(6H)	14	14.12	9730016TI	5P	110	26	-	56	12	9	12	3	086	●
M18X2.5	ISO2(6H)	15.5	15.63	9730018TI	5P	125	33	-	64	14	11	14	3	086	●
M20X2.5	ISO2(6H)	17.5	17.63	9730020TI	5P	140	33	-	71	16	12	15	3	086	●
M22X2.5	ISO2(6H)	19.5	19.63	9730022TI	5P	140	33	-	71	18	14.5	17	3	086	●
M24X3	ISO2(6H)	21	21.13	9730024TI	5P	160	37	-	82	18	14.5	17	3	086	●
DIN 374															
M8X1	ISO2(6H)	7	7.09	98308.0MTI	5P	90	19	-	46	6	4.9	8	3	086	●
M10X1.25	ISO2(6H)	8.8	8.85	9830010NTI	5P	100	23	-	51	7	5.5	8	3	086	●
M10X1	ISO2(6H)	9	9.09	9830010MTI	5P	90	19	-	46	7	5.5	8	3	086	●
M12X1.5	ISO2(6H)	10.5	10.6	98300120TI	5P	100	21	-	51	9	7	10	3	086	●
M12X1.25	ISO2(6H)	10.8	10.85	9830012NTI	5P	100	21	-	51	9	7	10	3	086	●
M14X1.5	ISO2(6H)	12.5	12.6	98300140TI	5P	100	21	-	51	11	9	12	3	086	●
M16X1.5	ISO2(6H)	14.5	14.6	98300160TI	5P	100	21	-	51	12	9	12	3	086	●
M18X1.5	ISO2(6H)	16.5	16.6	98300180TI	5P	110	24	-	56	14	11	14	3	086	●
M20X1.5	ISO2(6H)	18.5	18.6	98300200TI	5P	125	24	-	64	16	12	15	3	086	●
DIN 5156															
1/8-28	-	8.75	8.78	9930R02TI	5P	9.728	90	19	46	7	5.5	8	3	086	●
1/4-19	-	11.75	11.78	9930R04TI	5P	13.157	100	21	51	11	9	12	3	086	●
3/8-19	-	15.25	15.28	9930R06TI	5P	16.662	100	21	51	12	9	12	3	086	●
1/2-14	-	19	19.04	9930R08TI	5P	20.955	125	24	64	16	12	15	3	086	●

Intro

SP

SL

PO

DIN

ST

ROLL

CARBIDE

LONG

HAND TAPS

EG (STI)

SPECIAL THREADS, GAUGES

THREAD MILLS

DIES

CENTER DRILLS

Technical info

Intro

PM-PO

MS Material Specific Series

Spiral Pointed Taps for Hard Materials (<45HRC)



SP

SL



FEATURES

Material specific for through hole application.
 Specific design and high class HSSP for stable and long life on alloy steel and tool steel (30 ÷ 45HRC) application.
 Reliable and high performance tapping for the mould&die industry.

PO

Recommended Tapping Speeds Depending On Materials

ISO Vc (m/min)

P3	2÷10	★
P4	2÷7	★
P5	2÷7	★
P6	2÷5	★

★ 1st choice ☆ suitable

DIN

ST

ROLL

Product Features

ISO	Materials	Hardness	Recommended tapping speed (Vc <5m/min)	5m/min
P6	High tensile strength steel	40÷45 HRC		
P5	Tool steel (100MnCrW4-1.2510 40CrMnMo7-1.2311)	30÷40 HRC		
P4	High alloy steel (CrMo, NiCrMo)	25÷30 HRC		

Most Suitable (Red dashed line) Suitable (Red solid line)

CARBIDE

LONG

HAND TAPS

EG (STI)

SPECIAL THREADS, GAUGES

THREAD MILLS

DIES

CENTER DRILLS

Technical info

TYPE: EU_057

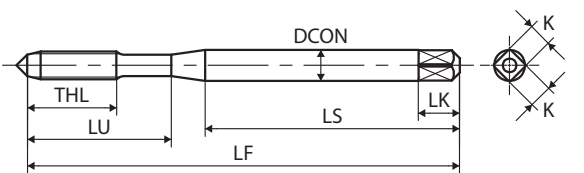

TYPE: EU_084

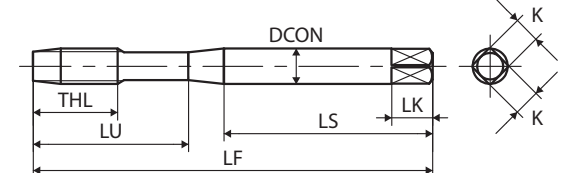

TYPE: EU_086

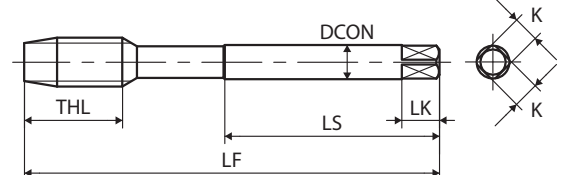

M	TCTR (tolerance)	 Hole Ø (mm)	Hole Ø (mm)	Code	THCHT (chamfer)	LF (mm)	THL (mm)	LU (mm)	LS (mm)	DCON (mm)	K (mm)	LK (mm)	NOF	Type	Stock
DIN 371															
M3X0.5	ISO2X(6HX)	2.5	2.56	PD3.0GBDPB	5.5P	56	9	18	34	3.5	2.7	6	3	057	●
M4X0.7	ISO2X(6HX)	3.3	3.38	PD4.0IBDPB	5.5P	63	13	21	38	4.5	3.4	6	3	057	●
M5X0.8	ISO2X(6HX)	4.2	4.28	PD5.0KBDPB	5.5P	70	14	25	39	6	4.9	8	3	057	●
M6X1	ISO2X(6HX)	5	5.09	PD6.0MBDPB	5.5P	80	15	30	45	6	4.9	8	3	057	●
M8X1.25	ISO2X(6HX)	6.8	6.85	PD8.0NBDPB	5.5P	90	19	35	47	8	6.2	9	3	084	●
M10X1.5	ISO2X(6HX)	8.5	8.6	PD10.0BDPB	5.5P	100	23	39	52	10	8	11	3	084	●
DIN 376															
M12X1.75	ISO2X(6HX)	10.3	10.36	PG012PBDPB	5.5P	110	26	-	56	9	7	10	3	086	●
M14X2	ISO2X(6HX)	12	12.12	PG014QBDPB	5.5P	110	26	-	56	11	9	12	3	086	●
M16X2	ISO2X(6HX)	14	14.12	PG016QBDPB	5.5P	110	26	-	56	12	9	12	3	086	●
M18X2.5	ISO2X(6HX)	15.5	15.63	PG018RBDPB	5.5P	125	33	-	64	14	11	14	4	086	●
M20X2.5	ISO2X(6HX)	17.5	17.63	PG020RBDPB	5.5P	140	33	-	71	16	12	15	4	086	●
M22X2.5	ISO2X(6HX)	19.5	19.63	PG022RBDPB	5.5P	140	33	-	71	18	14.5	17	4	086	●
M24X3	ISO2X(6HX)	21	21.13	PG024SBDPB	5.5P	160	37	-	82	18	14.5	17	4	086	●
M27X3	ISO2X(6HX)	24	24.13	PG027SBDPB	5.5P	160	37	-	82	20	16	19	4	086	●
M30X3.5	ISO2X(6HX)	26.5	26.63	PG030TBDPB	5.5P	180	44	-	92	22	18	21	4	086	●
DIN 374															
M10X1.25	ISO2X(6HX)	8.8	8.85	PM010NBDPB	5.5P	100	23	-	51	7	5.5	8	3	086	●
M12X1.5	ISO2X(6HX)	10.5	10.6	PM0120BDPB	5.5P	100	21	-	51	9	7	10	3	086	●
M12X1.25	ISO2X(6HX)	10.8	10.85	PM012NBDPB	5.5P	100	21	-	51	9	7	10	3	086	●
M14X1.5	ISO2X(6HX)	12.5	12.6	PM0140BDPB	5.5P	100	21	-	51	11	9	12	3	086	●
M16X1.5	ISO2X(6HX)	14.5	14.6	PM0160BDPB	5.5P	100	21	-	51	12	9	12	3	086	●
M18X1.5	ISO2X(6HX)	16.5	16.6	PM0180BDPB	5.5P	110	24	-	56	14	11	14	4	086	●
M20X1.5	ISO2X(6HX)	18.5	18.6	PM0200BDPB	5.5P	125	24	-	64	16	12	15	4	086	●
M22X1.5	ISO2X(6HX)	20.5	20.6	PM0220BDPB	5.5P	125	24	-	64	18	14.5	17	4	086	●
M24X1.5	ISO2X(6HX)	22.5	22.6	PM0240BDPB	5.5P	140	27	-	71	18	14.5	17	4	086	●
M27X1.5	ISO2X(6HX)	25.5	25.6	PM0270BDPB	5.5P	140	27	-	71	20	16	19	4	086	●
M30X1.5	ISO2X(6HX)	28.5	28.6	PM0300BDPB	5.5P	150	27	-	77	22	18	21	4	086	●

Intro

SP

SL

PO

DIN

ST

ROLL

CARBIDE

LONG

HAND
TAPS

EG (STI)

SPECIAL
THREADS,
GAUGESTHREAD
MILLS

DIES

CENTER
DRILLSTechnical
info

Intro

EH-PO

MS Material Specific Series

Spiral Pointed Taps for Hard Materials (<45HRC)



SP

SL



PO

Recommended Tapping Speeds Depending On Materials

DIN

ISO Vc (m/min)

P5 ≤5 ★

P6 ≤5 ★

ST

★ 1st choice ☆ suitable

ROLL

CARBIDE

LONG

HAND TAPS

EG (STI)

SPECIAL THREADS, GAUGES

THREAD MILLS

DIES

CENTER DRILLS

Technical info

FEATURES

Material specific for through hole application.

For high tensile strength steel <45HRC.

Specific geometry and HSSCo substrate allow stable and long life.

TYPE: EU_057

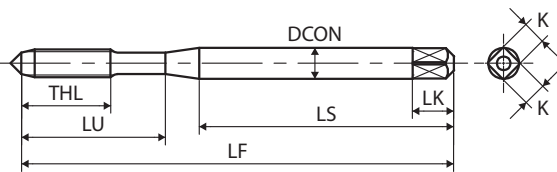

TYPE: EU_084

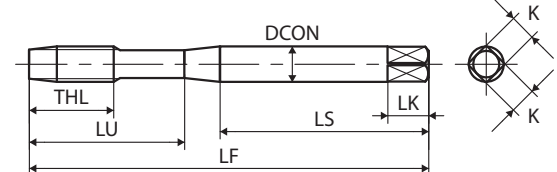

TYPE: EU_086

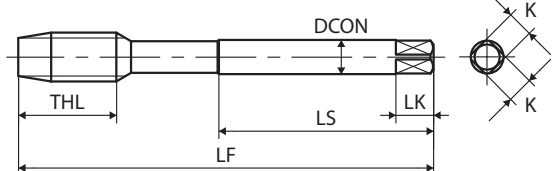

M	TCTR (tolerance)	 Hole Ø (mm)	Hole Ø (mm)	Code	THCHT (chamfer)	LF (mm)	THL (mm)	LU (mm)	LS (mm)	DCON (mm)	K (mm)	LK (mm)	NOF	Type	Stock
DIN 371															
M3X0.5	ISO2X(6HX)	2.5	2.56	PD3.0GBDCB	4.5P	56	9	18	34	3.5	2.7	6	3	057	●
M4X0.7	ISO2X(6HX)	3.3	3.38	PD4.0IBDCB	4.5P	63	13	21	38	4.5	3.4	6	3	057	●
M5X0.8	ISO2X(6HX)	4.2	4.28	PD5.0KBDCB	4.5P	70	14	25	39	6	4.9	8	3	057	●
M6X1	ISO2X(6HX)	5	5.09	PD6.0MBDCB	4.5P	80	15	30	45	6	4.9	8	3	057	●
M8X1.25	ISO2X(6HX)	6.8	6.85	PD8.0NBDCB	4.5P	90	19	35	47	8	6.2	9	3	084	●
M10X1.5	ISO2X(6HX)	8.5	8.6	PD0100BDCB	4.5P	100	23	39	52	10	8	11	3	084	●
DIN 376															
M12X1.75	ISO2X(6HX)	10.3	10.36	PG012PBDCB	4.5P	110	26	-	56	9	7	10	3	086	●
M14X2	ISO2X(6HX)	12	12.12	PG014QBDCB	4.5P	110	26	-	56	11	9	12	3	086	●
M16X2	ISO2X(6HX)	14	14.12	PG016QBDCB	4.5P	110	26	-	56	12	9	12	3	086	●
M18X2.5	ISO2X(6HX)	15.5	15.63	PG018RBDCB	4.5P	125	33	-	64	14	11	14	3	086	●
M20X2.5	ISO2X(6HX)	17.5	17.63	PG020RBDCB	4.5P	140	33	-	71	16	12	15	3	086	●
M22X2.5	ISO2X(6HX)	19.5	19.63	PG022RBDCB	4.5P	140	33	-	71	18	14.5	17	3	086	○
M24X3	ISO2X(6HX)	21	21.13	PG024SBDCB	4.5P	160	37	-	82	18	14.5	17	3	086	●
DIN 374															
M8X1	ISO2X(6HX)	7	7.09	PM8.0MBDCB	4.5P	90	19	-	46	6	4.9	8	3	086	▽
M10X1.25	ISO2X(6HX)	8.8	8.85	PM010NBDCB	4.5P	100	23	-	51	7	5.5	8	3	086	▽
M10X1	ISO2X(6HX)	9	9.09	PM010MBDCB	4.5P	90	19	-	46	7	5.5	8	3	086	▽
M12X1.5	ISO2X(6HX)	10.5	10.6	PM0120BDCB	4.5P	100	21	-	51	9	7	10	3	086	▽
M12X1.25	ISO2X(6HX)	10.8	10.85	PM012NBDCB	4.5P	100	21	-	51	9	7	10	3	086	▽
M14X1.5	ISO2X(6HX)	12.5	12.6	PM0140BDCB	4.5P	100	21	-	51	11	9	12	3	086	▽
M16X1.5	ISO2X(6HX)	14.5	14.6	PM0160BDCB	4.5P	100	21	-	51	12	9	12	3	086	▽
M18X1.5	ISO2X(6HX)	16.5	16.6	PM0180BDCB	4.5P	110	24	-	56	14	11	14	3	086	▽
M20X1.5	ISO2X(6HX)	18.5	18.6	PM0200BDCB	4.5P	125	24	-	64	16	12	15	3	086	▽

Intro

SP

SL

PO

DIN

ST

ROLL

CARBIDE

LONG

HAND
TAPS

EG (STI)

SPECIAL
THREADS,
GAUGESTHREAD
MILLS

DIES

CENTER
DRILLSTechnical
info

Intro

PO-VA

MS Material Specific Series

Spiral Pointed Taps for Stainless Steel



SP

SL



PO

Recommended Tapping Speeds Depending On Materials

DIN

ISO	Vc (m/min)	★	ISO	Vc (m/min)	★
P1	≤10	★	M1	≤10	★
P2	≤10	★	M2	≤10	☆
P3	≤10	★			
P4	≤10	☆			
P7	≤10	★			

★ 1st choice ☆ suitable

ST

ROLL

CARBIDE

LONG

HAND TAPS

EG (STI)

SPECIAL THREADS, GAUGES

THREAD MILLS

DIES

CENTER DRILLS

Technical info

FEATURES

Material specific for through hole application.
Most suitable for stainless steel, steel and alloy steel.
OX treatment reduces welding troubles.

TYPE: EU_001

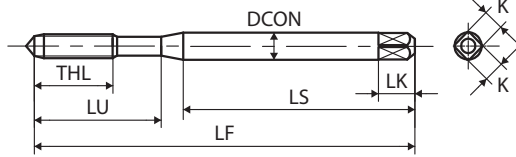

TYPE: EU_057

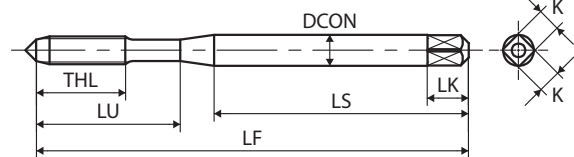

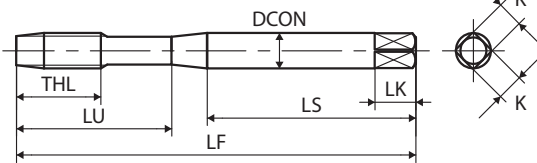

TYPE: EU_084



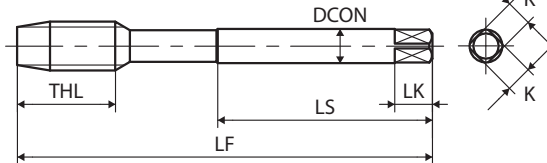

TYPE: EU_086



M	TCTR (tolerance)	 Hole Ø (mm)	Hole Ø (mm)	Code	THCHT (chamfer)	LF (mm)	THL (mm)	LU (mm)	LS (mm)	DCON (mm)	K (mm)	LK (mm)	NOF	Type	Stock
DIN 371															
M2X0.4	ISO2X(6HX)	1.6	1.65	PD2.0EBGEX	4.5P	45	8	-	32	2.8	2.1	5	2	001	●
M2.5X0.45	ISO2X(6HX)	2.1	2.11	PD2.5FBGEX	4.5P	50	8	15	33	2.8	2.1	5	2	057	●
M3X0.5	ISO2X(6HX)	2.5	2.56	PD3.0GBGEX	4.5P	56	9	18	34	3.5	2.7	6	3	057	●
M4X0.7	ISO2X(6HX)	3.3	3.38	PD4.0IBGEX	4.5P	63	13	21	38	4.5	3.4	6	3	057	●
M5X0.8	ISO2X(6HX)	4.2	4.28	PD5.0KBGEX	4.5P	70	14	25	39	6	4.9	8	3	057	●
M6X1	ISO2X(6HX)	5	5.09	PD6.0MBGEX	4.5P	80	15	30	45	6	4.9	8	3	057	●
M8X1.25	ISO2X(6HX)	6.8	6.85	PD8.0NBGEX	4.5P	90	19	35	47	8	6.2	9	3	084	●
M10X1.5	ISO2X(6HX)	8.5	8.6	PD0100BGEX	4.5P	100	23	39	52	10	8	11	3	084	●

M	TCTR (tolerance)	 Hole Ø (mm)	Hole Ø (mm)	Code	THCHT (chamfer)	LF (mm)	THL (mm)	LU (mm)	LS (mm)	DCON (mm)	K (mm)	LK (mm)	NOF	Type	Stock
DIN 376															
M8X1.25	ISO2X(6HX)	6.8	6.85	PG8.0NBGEX	4.5P	90	19	-	46	6	4.9	8	3	086	●
M10X1.5	ISO2X(6HX)	8.5	8.6	PG0100BGEX	4.5P	100	23	-	51	7	5.5	8	3	086	●
M12X1.75	ISO2X(6HX)	10.3	10.36	PG012PBGEX	4.5P	110	26	-	56	9	7	10	3	086	●
M14X2	ISO2X(6HX)	12	12.12	PG014QBGEX	4.5P	110	26	-	56	11	9	12	3	086	●
M16X2	ISO2X(6HX)	14	14.12	PG016QBGEX	4.5P	110	26	-	56	12	9	12	3	086	●
M18X2.5	ISO2X(6HX)	15.5	15.63	PG018RBGEX	4.5P	125	33	-	64	14	11	14	3	086	●
M20X2.5	ISO2X(6HX)	17.5	17.63	PG020RBGEX	4.5P	140	33	-	71	16	12	15	3	086	●
M22X2.5	ISO2X(6HX)	19.5	19.63	PG022RBGEX	4.5P	140	33	-	71	18	14.5	17	3	086	●
M24X3	ISO2X(6HX)	21	21.13	PG024SBGEX	4.5P	160	37	-	82	18	14.5	17	3	086	●
M27X3	ISO2X(6HX)	24	24.13	PG027SBGEX	4.5P	160	37	-	82	20	16	19	4	086	●
M30X3.5	ISO2X(6HX)	26.5	26.63	PG030TBGEX	4.5P	180	44	-	92	22	18	21	4	086	●
M36X4	ISO2X(6HX)	32	32.12	PG036UBGEX	4.5P	200	52	-	102	28	22	25	4	086	●

MF	TCTR (tolerance)	 Hole Ø (mm)	Hole Ø (mm)	Code	THCHT (chamfer)	LF (mm)	THL (mm)	LU (mm)	LS (mm)	DCON (mm)	K (mm)	LK (mm)	NOF	Type	Stock
DIN 374															
M8X1	ISO2X(6HX)	7	7.09	PM8.0MBGEX	4.5P	90	19	-	46	6	4.9	8	3	086	●
M10X1.25	ISO2X(6HX)	8.8	8.85	PM010NBGEX	4.5P	100	23	-	51	7	5.5	8	3	086	●
M10X1	ISO2X(6HX)	9	9.09	PM010MBGEX	4.5P	90	19	-	46	7	5.5	8	3	086	●
M12X1.5	ISO2X(6HX)	10.5	10.6	PM0120BGEX	4.5P	100	21	-	51	9	7	10	3	086	●
M12X1.25	ISO2X(6HX)	10.8	10.85	PM012NBGEX	4.5P	100	21	-	51	9	7	10	3	086	●
M12X1	ISO2X(6HX)	11	11.09	PM012MBGEX	4.5P	100	21	-	51	9	7	10	3	086	●
M14X1.5	ISO2X(6HX)	12.5	12.6	PM0140BGEX	4.5P	100	21	-	51	11	9	12	3	086	●
M16X1.5	ISO2X(6HX)	14.5	14.6	PM0160BGEX	4.5P	100	21	-	51	12	9	12	3	086	●
M18X1.5	ISO2X(6HX)	16.5	16.6	PM0180BGEX	4.5P	110	24	-	56	14	11	14	3	086	●
M20X1.5	ISO2X(6HX)	18.5	18.6	PM0200BGEX	4.5P	125	24	-	64	16	12	15	3	086	●
M22X1.5	ISO2X(6HX)	20.5	20.6	PM0220BGEX	4.5P	125	24	-	64	18	14.5	17	3	086	●
M24X1.5	ISO2X(6HX)	22.5	22.6	PM0240BGEX	4.5P	140	27	-	71	18	14.5	17	3	086	●

UNC	TCTR (tolerance)	 Hole Ø (mm)	Hole Ø (mm)	Code	THCHT (chamfer)	LF (mm)	THL (mm)	LU (mm)	LS (mm)	DCON (mm)	K (mm)	LK (mm)	NOF	Type	Stock
DIN 371															
No.4-40UNC	2BX	2.3	2.33	PDUN4HYGEX	4.5P	56	9	18	34	3.5	2.7	6	3	057	●
No.6-32UNC	2BX	2.8	2.83	PDUN6JYGEX	4.5P	56	11	19	32	4	3	6	3	057	●
No.8-32UNC	2BX	3.4	3.47	PDUN8JYGEX	4.5P	63	13	21	38	4.5	3.4	6	3	057	●
No.10-24UNC	2BX	3.89	3.9	PDUNAMYGEX	4.5P	70	14	24	39	6	4.9	8	3	057	●
1/4-20UNC	2BX	5.1	5.19	PDU04NYGEX	4.5P	80	15	30	42	7	5.5	8	3	057	●
5/16-18UNC	2BX	6.6	6.65	PDU050YGEX	4.5P	90	19	35	47	8	6.2	9	3	084	●

Intro

SP

SL

PO

DIN

ST

ROLL

CARBIDE

LONG

HAND TAPS

EG (STI)

SPECIAL THREADS, GAUGES

THREAD MILLS

DIES

CENTER DRILLS

Technical info

Spiral Pointed Taps

Intro

UNC	TCTR (tolerance)	 Hole Ø (mm)	Hole Ø (mm)	Code	THCHT (chamfer)	LF (mm)	THL (mm)	LU (mm)	LS (mm)	DCON (mm)	K (mm)	LK (mm)	NOF	Type	Stock
DIN 371															
3/8-16UNC	2BX	8	8.07	PDU06PYGEX	4.5P	100	23	39	54	9	7	10	3	084	●

SP

UNC	TCTR (tolerance)	 Hole Ø (mm)	Hole Ø (mm)	Code	THCHT (chamfer)	LF (mm)	THL (mm)	LU (mm)	LS (mm)	DCON (mm)	K (mm)	LK (mm)	NOF	Type	Stock
DIN 376															
7/16-14UNC	2BX	9.4	9.45	PGU07QYGEX	4.5P	100	23	-	51	8	6.2	9	3	086	●

SL

1/2-13UNC	2BX	10.9	10.91	PGU08RYGEX	4.5P	110	26	-	56	9	7	10	3	086	●
9/16-12UNC	2BX	12.2	12.33	PGU09SYGEX	4.5P	110	26	-	56	11	9	12	3	086	●

PO

5/8-11UNC	2BX	13.6	13.75	PGU10UYGEX	4.5P	110	26	-	56	12	9	12	3	086	●
3/4-10UNC	2BX	16.6	16.7	PGU12VYGEX	4.5P	125	33	-	64	14	11	14	3	086	●

DIN

7/8-9UNC	2BX	19.6	19.61	PGU14WYGEX	4.5P	140	33	-	71	18	14.5	17	3	086	●
1-8UNC	2BX	22.3	22.45	PGU16XYGEX	4.5P	160	37	-	82	18	14.5	17	3	086	●

ST

UNF	TCTR (tolerance)	 Hole Ø (mm)	Hole Ø (mm)	Code	THCHT (chamfer)	LF (mm)	THL (mm)	LU (mm)	LS (mm)	DCON (mm)	K (mm)	LK (mm)	NOF	Type	Stock
DIN 371															
No.10-32UNF	2BX	4.1	4.12	PDUNAJYGEX	4.5P	70	14	24	39	6	4.9	8	3	057	●

ROLL

1/4-28UNF	2BX	5.5	5.53	PDU04KYGEX	4.5P	80	15	30	42	7	5.5	8	3	057	●
------------------	-----	-----	------	------------	------	----	----	----	----	---	-----	---	---	-----	---

CARBIDE

UNF	TCTR (tolerance)	 Hole Ø (mm)	Hole Ø (mm)	Code	THCHT (chamfer)	LF (mm)	THL (mm)	LU (mm)	LS (mm)	DCON (mm)	K (mm)	LK (mm)	NOF	Type	Stock
DIN 374															
5/16-24UNF	2BX	6.9	6.97	PMU05MYGEX	4.5P	90	19	-	46	6	4.9	8	3	086	●

LONG

3/8-24UNF	2BX	8.5	8.57	PMU06MYGEX	4.5P	100	23	-	51	7	5.5	8	3	086	●
1/2-20UNF	2BX	11.5	11.54	PMU08NYGEX	4.5P	100	21	-	51	9	7	10	3	086	●

HAND TAPS

9/16-18UNF	2BX	12.9	13	PMU09OYGEX	4.5P	100	21	-	51	11	9	12	3	086	●
5/8-18UNF	2BX	14.5	14.6	PMU10OYGEX	4.5P	100	21	-	51	12	9	12	3	086	●

EG (STI)

G(BSP)	TCTR (tolerance)	 Hole Ø (mm)	Hole Ø (mm)	Code	THCHT (chamfer)	Basic major Ø (mm)	LF (mm)	THL (mm)	LS (mm)	DCON (mm)	K (mm)	LK (mm)	NOF	Type	Stock
DIN 5156															
1/8-28	-	8.75	8.78	UDYCZ001	4.5P	9.728	90	19	46	7	5.5	8	3	086	●

SPECIAL THREADS, GAUGES

1/4-19	-	11.75	11.78	UDYCZ002	4.5P	13.157	100	21	51	11	9	12	3	086	●
3/8-19	-	15.25	15.28	UDYCZ003	4.5P	16.662	100	21	51	12	9	12	3	086	●
1/2-14	-	19	19.04	UDYCZ004	4.5P	20.955	125	24	64	16	12	15	3	086	●
3/4-14	-	24.5	24.52	UDYCZ005	4.5P	26.441	140	27	71	20	16	19	4	086	●
1-11	-	30.75	30.77	UKYCZ010	4.5P	33.249	160	29	82	25	20	23	4	086	●

THREAD MILLS

DIES

CENTER DRILLS

Technical info

PO-VA TiCN

MS Material Specific Series

Spiral Pointed Taps for Stainless Steel, Coated



FEATURES

Material specific for through hole application.
Most suitable for stainless steel, steel and alloy steel.
Suitable coating improves wear, heat and welding resistance.

Recommended Tapping Speeds Depending On Materials

ISO	Vc (m/min)	★	ISO	Vc (m/min)	★
P1	≤15	★	M1	≤10	★
P2	≤15	★	M2	≤10	☆
P3	≤10	★			
P4	≤10	☆			
P7	≤10	★			

★ 1st choice ☆ suitable

This item will be gradually replaced by:

· VUPO page 210

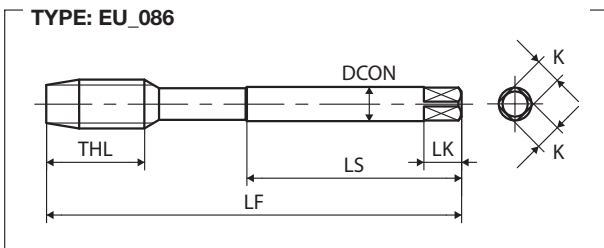
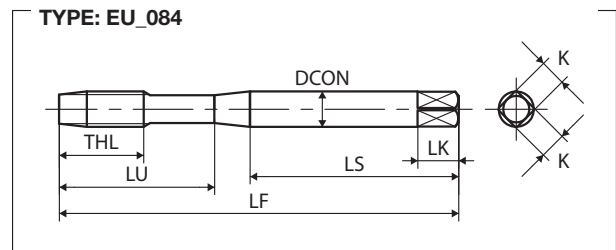
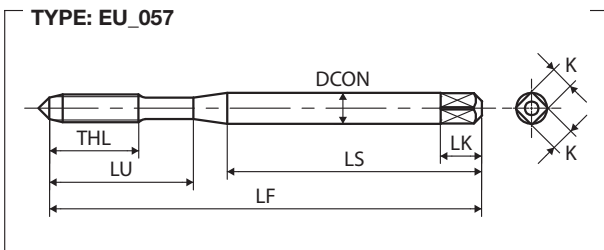

M	TCTR (tolerance)	Hole Ø (mm)	Hole Ø (mm)	Code	THCHT (chamfer)	LF (mm)	THL (mm)	LU (mm)	LS (mm)	DCON (mm)	K (mm)	LK (mm)	NOF	Type	Stock
DIN 371															
M3X0.5	ISO2X(6HX)	2.5	2.56	PD3.0GBGET	4.5P	56	9	18	34	3.5	2.7	6	3	057	▽
M4X0.7	ISO2X(6HX)	3.3	3.38	PD4.0IBGET	4.5P	63	13	21	38	4.5	3.4	6	3	057	▽
M5X0.8	ISO2X(6HX)	4.2	4.28	PD5.0KBGET	4.5P	70	14	25	39	6	4.9	8	3	057	▽
M6X1	ISO2X(6HX)	5	5.09	PD6.0MBGET	4.5P	80	15	30	45	6	4.9	8	3	057	▽
M8X1.25	ISO2X(6HX)	6.8	6.85	PD8.0NBGET	4.5P	90	19	35	47	8	6.2	9	3	084	▽
M10X1.5	ISO2X(6HX)	8.5	8.6	PD10.0BGET	4.5P	100	23	39	52	10	8	11	3	084	▽
M	TCTR (tolerance)	Hole Ø (mm)	Hole Ø (mm)	Code	THCHT (chamfer)	LF (mm)	THL (mm)	LU (mm)	LS (mm)	DCON (mm)	K (mm)	LK (mm)	NOF	Type	Stock
DIN 376															
M12X1.75	ISO2X(6HX)	10.3	10.36	PG012PBGET	4.5P	110	26	-	56	9	7	10	3	086	▽
M14X2	ISO2X(6HX)	12	12.12	PG014QBGET	4.5P	110	26	-	56	11	9	12	3	086	▽
M16X2	ISO2X(6HX)	14	14.12	PG016QBGET	4.5P	110	26	-	56	12	9	12	3	086	▽
M20X2.5	ISO2X(6HX)	17.5	17.63	PG020RBGET	4.5P	140	33	-	71	16	12	15	3	086	▽

- Intro
- SP
- SL
- PO**
- DIN**
- ST
- ROLL
- CARBIDE
- LONG
- HAND TAPS
- EG (STI)
- SPECIAL THREADS, GAUGES
- THREAD MILLS
- DIES
- CENTER DRILLS
- Technical info

Intro

ZEN-P



MS Material Specific Series

Spiral Pointed Taps for Nickel Base Alloys

SP

SL



FEATURES

Material specific for through hole application.
Specific design and NI+OX treatment allow high performance on Nickel base alloys.
Also suitable for stainless steel and high alloy steel.

PO

Recommended Tapping Speeds Depending On Materials

DIN

ISO	Vc (m/min)	ISO	Vc (m/min)	ISO	Vc (m/min)
P3	5÷15 ★	M1	5÷15 ★	S1	5÷10 ★
P4	5÷15 ★	M2	5÷15 ★	S2	5÷10 ★
P5	5÷10 ☆	M3	4÷8 ★	S3	3÷6 ☆
P7	5÷15 ★				
P8	4÷8 ★				

★ 1st choice ☆ suitable

ST

ROLL

CARBIDE

LONG

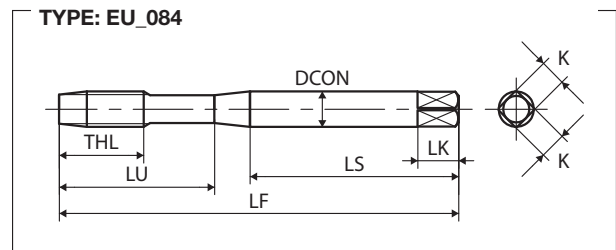
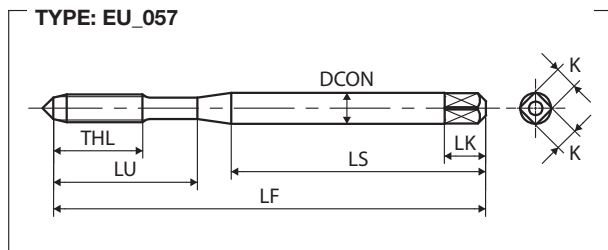

HAND TAPS

EG (STI)

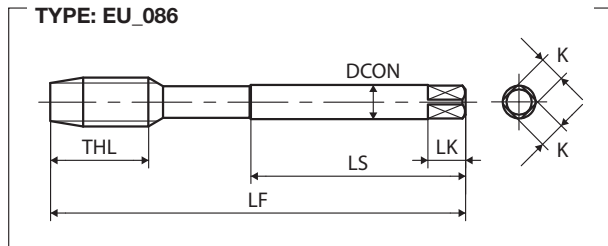

SPECIAL THREADS, GAUGES







THREAD MILLS

DIES

CENTER DRILLS

Technical info

M	TCTR (tolerance)	Hole Ø (mm)	Hole Ø (mm)	Code	THCHT (chamfer)	LF (mm)	THL (mm)	LU (mm)	LS (mm)	DCON (mm)	K (mm)	LK (mm)	NOF	Type	Stock
DIN 371															
M3X0.5	ISO2X(6HX)	2.5	2.56	PD3.0GBJPW	4.5P	56	9	18	34	3.5	2.7	6	3	057	●
M4X0.7	ISO2X(6HX)	3.3	3.38	PD4.0IBJPW	4.5P	63	13	21	38	4.5	3.4	6	3	057	●
M5X0.8	ISO2X(6HX)	4.2	4.28	PD5.0KBJPW	4.5P	70	14	25	39	6	4.9	8	3	057	●
M6X1	ISO2X(6HX)	5	5.09	PD6.0MBJPW	4.5P	80	15	30	45	6	4.9	8	3	057	●
M8X1.25	ISO2X(6HX)	6.8	6.85	PD8.0NBJPW	4.5P	90	19	35	47	8	6.2	9	3	084	●
M10X1.5	ISO2X(6HX)	8.5	8.6	PD10.0BJPW	4.5P	100	23	39	52	10	8	11	3	084	●

M	TCTR (tolerance)	 Hole Ø (mm)	Hole Ø (mm)	Code	THCHT (chamfer)	LF (mm)	THL (mm)	LU (mm)	LS (mm)	DCON (mm)	K (mm)	LK (mm)	NOF	Type	Stock
DIN 376															
M12X1.75	ISO2X(6HX)	10.3	10.36	PG012PBJPW	4.5P	110	26	-	56	9	7	10	3	086	●
M14X2	ISO2X(6HX)	12	12.12	PG014QBJPW	4.5P	110	26	-	56	11	9	12	3	086	●
M16X2	ISO2X(6HX)	14	14.12	PG016QBJPW	4.5P	110	26	-	56	12	9	12	3	086	●
M18X2.5	ISO2X(6HX)	15.5	15.63	PG018RBJPW	4.5P	125	33	-	64	14	11	14	3	086	○
M20X2.5	ISO2X(6HX)	17.5	17.63	PG020RBJPW	4.5P	140	33	-	71	16	12	15	3	086	●
M24X3	ISO2X(6HX)	21	21.13	PG024SBJPW	4.5P	160	37	-	82	18	14.5	17	3	086	●
MF	TCTR (tolerance)	 Hole Ø (mm)	Hole Ø (mm)	Code	THCHT (chamfer)	LF (mm)	THL (mm)	LU (mm)	LS (mm)	DCON (mm)	K (mm)	LK (mm)	NOF	Type	Stock
DIN 374															
M10X1.25	ISO2X(6HX)	8.8	8.85	PM010NBJPW	4.5P	100	23	-	51	7	5.5	8	3	086	●
M12X1.5	ISO2X(6HX)	10.5	10.6	PM0120BJPW	4.5P	100	21	-	51	9	7	10	3	086	●
M12X1.25	ISO2X(6HX)	10.8	10.85	PM012NBJPW	4.5P	100	21	-	51	9	7	10	3	086	●
M14X1.5	ISO2X(6HX)	12.5	12.6	PM0140BJPW	4.5P	100	21	-	51	11	9	12	3	086	●
M16X1.5	ISO2X(6HX)	14.5	14.6	PM0160BJPW	4.5P	100	21	-	51	12	9	12	3	086	●
UNC	TCTR (tolerance)	 Hole Ø (mm)	Hole Ø (mm)	Code	THCHT (chamfer)	LF (mm)	THL (mm)	LU (mm)	LS (mm)	DCON (mm)	K (mm)	LK (mm)	NOF	Type	Stock
DIN 371															
No.6-32UNC	2BX	2.8	2.83	PDUN6JYJPW	4.5P	56	11	19	32	4	3	6	3	057	●
No.8-32UNC	2BX	3.4	3.47	PDUN8JYJPW	4.5P	63	13	21	38	4.5	3.4	6	3	057	●
No.10-24UNC	2BX	3.89	3.9	PDUNAMYJPW	4.5P	70	14	24	39	6	4.9	8	3	057	●
1/4-20UNC	2BX	5.1	5.19	PDU04NYJPW	4.5P	80	15	30	42	7	5.5	8	3	057	●
5/16-18UNC	2BX	6.6	6.65	PDU05OYJPW	4.5P	90	19	35	47	8	6.2	9	3	084	●
3/8-16UNC	2BX	8	8.07	PDU06PYJPW	4.5P	100	23	39	54	9	7	10	3	084	●
UNC	TCTR (tolerance)	 Hole Ø (mm)	Hole Ø (mm)	Code	THCHT (chamfer)	LF (mm)	THL (mm)	LU (mm)	LS (mm)	DCON (mm)	K (mm)	LK (mm)	NOF	Type	Stock
DIN 376															
1/2-13UNC	2BX	10.9	10.91	PGU08RYJPW	4.5P	110	26	-	56	9	7	10	3	086	●
5/8-11UNC	2BX	13.6	13.75	PGU10UYJPW	4.5P	110	26	-	56	12	9	12	3	086	●
3/4-10UNC	2BX	16.6	16.7	PGU12VYJPW	4.5P	125	33	-	64	14	11	14	3	086	●
UNF	TCTR (tolerance)	 Hole Ø (mm)	Hole Ø (mm)	Code	THCHT (chamfer)	LF (mm)	THL (mm)	LU (mm)	LS (mm)	DCON (mm)	K (mm)	LK (mm)	NOF	Type	Stock
DIN 371															
No.10-32UNF	2BX	4.1	4.12	PDUNAJYJPW	4.5P	70	14	24	39	6	4.9	8	3	057	●
1/4-28UNF	2BX	5.5	5.53	PDU04KYJPW	4.5P	80	15	30	42	7	5.5	8	3	057	●
UNF	TCTR (tolerance)	 Hole Ø (mm)	Hole Ø (mm)	Code	THCHT (chamfer)	LF (mm)	THL (mm)	LU (mm)	LS (mm)	DCON (mm)	K (mm)	LK (mm)	NOF	Type	Stock
DIN 374															
5/16-24UNF	2BX	6.9	6.97	PMU05MYJPW	4.5P	90	19	-	46	6	4.9	8	3	086	●
3/8-24UNF	2BX	8.5	8.57	PMU06MYJPW	4.5P	100	23	-	51	7	5.5	8	3	086	●
1/2-20UNF	2BX	11.5	11.54	PMU08NYJPW	4.5P	100	21	-	51	9	7	10	3	086	●
5/8-18UNF	2BX	14.5	14.6	PMU10OYJPW	4.5P	100	21	-	51	12	9	12	3	086	●
3/4-16UNF	2BX	17.5	17.59	PMU12PYJPW	4.5P	110	24	-	56	14	11	14	3	086	●

Intro

SP

SL

PO

DIN

ST

ROLL

CARBIDE

LONG

HAND
TAPS

EG (STI)

SPECIAL
THREADS,
GAUGESTHREAD
MILLS

DIES

CENTER
DRILLSTechnical
info

Intro

PO

GP General Purpose Series

Spiral Pointed Taps



SP

SL



FEATURES

General purpose for through hole application.

For steel application at medium-low cutting speed, also suitable for non-ferrous materials.

PO

Recommended Tapping Speeds Depending On Materials

ISO	Vc (m/min)	ISO	Vc (m/min)
P1	5÷10 ☆	N1	5÷10 ☆
P2	5÷10 ★	N2	5÷10 ☆
P3	5÷10 ☆	N3	5÷10 ☆
P4	5÷8 ☆	N4	5÷10 ☆

★ 1st choice ☆ suitable

JIS

ST

ROLL

CARBIDE

LONG

HAND TAPS

EG (STI)

SPECIAL THREADS, GAUGES

THREAD MILLS

DIES

CENTER DRILLS

Technical info

TYPE: PO_005

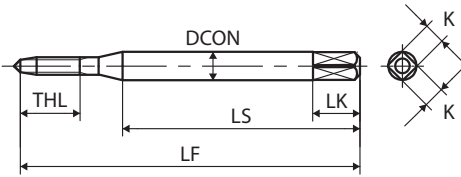

TYPE: PO_001

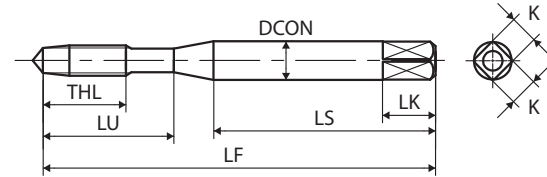

TYPE: PO_002

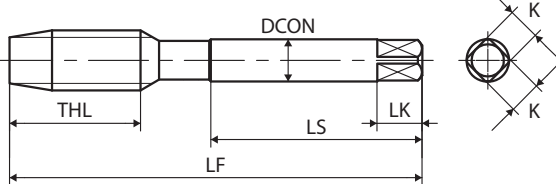

TYPE: PO_037

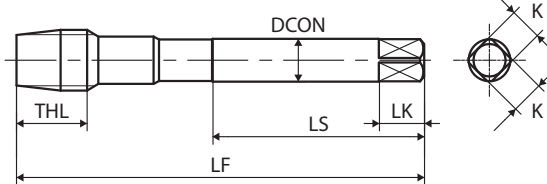

M	TCTR (tolerance)	\varnothing (mm)	Hole \varnothing (mm)	Code	THCHT (chamfer)	LF (mm)	THL (mm)	LU (mm)	LS (mm)	DCON (mm)	K (mm)	LK (mm)	NOF	Type	Stock
JIS															
M1.2X0.25	P1	0.95	0.97	POP1.2B	5P	36	4.5	-	24	3	2.5	5	2	005	●
M1.4X0.3	P1	1.1	1.13	POP1.4C	5P	36	5.4	-	24	3	2.5	5	2	005	●
	P2(P1+15)	1.1	1.13	POQ1.4C	5P	36	5.4	-	24	3	2.5	5	2	005	○
	P3(P1+30)	1.1	1.13	POR1.4C	5P	36	5.4	-	24	3	2.5	5	2	005	○
M1.6X0.35	P2	1.25	1.3	POQ1.6D	5P	36	6.3	-	24	3	2.5	5	2	005	●
	P3(P2+15)	1.25	1.3	POR1.6D	5P	36	6.3	-	24	3	2.5	5	2	005	○
M1.7X0.35	P2	1.35	1.4	POQ1.7D	5P	36	6.3	-	24	3	2.5	5	2	005	●
	P3(P2+15)	1.35	1.4	POR1.7D	5P	36	6.3	-	24	3	2.5	5	2	005	○
	P4(P2+30)	1.35	1.4	POS1.7D	5P	36	6.3	-	24	3	2.5	5	2	005	○
M1.8X0.35	P2	1.45	1.5	POQ1.8D	5P	42	6.3	-	27	3	2.5	5	2	005	●
M2X0.4	P2	1.6	1.65	POQ2.0E	5P	42	7.2	12	27	3	2.5	5	3	001	○
	P3(P2+15)	1.6	1.65	POR2.0E	5P	42	7.2	12	27	3	2.5	5	3	001	○
	P4(P2+30)	1.6	1.65	POS2.0E	5P	42	7.2	12	27	3	2.5	5	3	001	○
M2.2X0.45	P2	1.75	1.81	POQ2.2F	5P	42	8.1	12	27	3	2.5	5	3	001	●
M2.3X0.4	P2	1.9	1.95	POQ2.3E	5P	42	7.2	12	27	3	2.5	5	3	001	●
	P3(P2+15)	1.9	1.95	POR2.3E	5P	42	7.2	12	27	3	2.5	5	3	001	○
	P4(P2+30)	1.9	1.95	POS2.3E	5P	42	7.2	12	27	3	2.5	5	3	001	○
M2.5X0.45	P2	2.1	2.11	POQ2.5F	5P	46	8.1	14	29	3	2.5	5	3	001	○
	P3(P2+15)	2.1	2.11	POR2.5F	5P	46	8.1	14	29	3	2.5	5	3	001	○
	P4(P2+30)	2.1	2.11	POS2.5F	5P	46	8.1	14	29	3	2.5	5	3	001	○
M2.6X0.45	P2	2.2	2.21	POQ2.6F	5P	46	8.1	14	29	3	2.5	5	3	001	○
	P3(P2+15)	2.2	2.21	POR2.6F	5P	46	8.1	14	29	3	2.5	5	3	001	○
	P4(P2+30)	2.2	2.21	POS2.6F	5P	46	8.1	14	29	3	2.5	5	3	001	○
M3M0.6	P2	2.45	2.47	POQ3.0H	5P	46	9	14	26	4	3.2	6	3	001	○
M3X0.5	P2	2.5	2.56	POQ3.0G	5P	46	9	14	26	4	3.2	6	3	001	○
	P3(P2+15)	2.5	2.56	POR3.0G	5P	46	9	14	26	4	3.2	6	3	001	○
	P4(P2+30)	2.5	2.56	POS3.0G	5P	46	9	14	26	4	3.2	6	3	001	○
M3.5X0.6	P2	2.9	2.97	POQ3.5H	5P	52	11	16	29	5	4	7	3	001	○
	P3(P2+15)	2.9	2.97	POR3.5H	5P	52	11	16	29	5	4	7	3	001	○
	P4(P2+30)	2.9	2.97	POS3.5H	5P	52	11	16	29	5	4	7	3	001	○
M4M0.75	P2	3.3	3.33	POQ4.0J	5P	52	11	17	29	5	4	7	3	001	○
M4X0.7	P2	3.3	3.38	POQ4.0I	5P	52	11	17	29	5	4	7	3	001	○
	P3(P2+20)	3.3	3.38	POR4.0I	5P	52	11	17	29	5	4	7	3	001	○
	P4(P2+40)	3.3	3.38	POS4.0I	5P	52	11	17	29	5	4	7	3	001	○
M4.5X0.75	P2	3.8	3.83	POQ4.5J	5P	60	13	21	33	5.5	4.5	7	3	001	●
M5M0.9	P2	4.15	4.19	POQ5.0L	5P	60	13	22	33	5.5	4.5	7	3	001	○
M5X0.8	P2	4.2	4.28	POQ5.0K	5P	60	13	22	33	5.5	4.5	7	3	001	○
	P3(P2+20)	4.2	4.28	POR5.0K	5P	60	13	22	33	5.5	4.5	7	3	001	○
	P4(P2+40)	4.2	4.28	POS5.0K	5P	60	13	22	33	5.5	4.5	7	3	001	○
M5.5X0.9	P2	4.65	4.69	POQ5.5L	5P	62	15	26	33	6	4.5	7	3	001	●
M6X1	P2	5	5.09	POQ6.0M	5P	62	15	26	33	6	4.5	7	3	001	○
	P3(P2+20)	5	5.09	POR6.0M	5P	62	15	26	33	6	4.5	7	3	001	○
	P4(P2+40)	5	5.09	POS6.0M	5P	62	15	26	33	6	4.5	7	3	001	○
M7X1	P2	6	6.09	POQ7.0M	5P	70	19	-	36	6.2	5	8	3	002	○
	P3(P2+20)	6	6.09	POR7.0M	5P	70	19	-	36	6.2	5	8	3	002	○
M8X1.25	P3	6.8	6.85	POR8.0N	5P	70	19	-	36	6.2	5	8	3	002	○
	P4(P3+20)	6.8	6.85	POS8.0N	5P	70	19	-	36	6.2	5	8	3	002	○

Intro

SP

SL

PO

JIS

ST

ROLL

CARBIDE

LONG

HAND
TAPS

EG (STI)

SPECIAL
THREADS,
GAUGESTHREAD
MILLS

DIES

CENTER
DRILLSTechnical
info

Spiral Pointed Taps

Intro

M	TCTR (tolerance)	\varnothing (mm)	Hole \varnothing (mm)	Code	THCHT (chamfer)	LF (mm)	THL (mm)	LU (mm)	LS (mm)	DCON (mm)	K (mm)	LK (mm)	NOF	Type	Stock
JIS															
M9X1.25	P3	7.8	7.85	POR9.0N	5P	75	23	-	38	7	5.5	8	3	002	○
	P3	8.5	8.6	POR0100	5P	75	23	-	38	7	5.5	8	3	002	○
M10X1.5	P4(P3+20)	8.5	8.6	POS0100	5P	75	23	-	38	7	5.5	8	3	002	○
	P4	9.5	9.6	POS0110	5P	82	26	-	42	8.5	6.5	9	3	002	○
M11X1.5	P4	10.3	10.36	POS012P	5P	82	26	-	42	8.5	6.5	9	3	002	○
	P5(P4+20)	10.3	10.36	POT012P	5P	82	26	-	42	8.5	6.5	9	3	002	○
	P6(P4+40)	10.3	10.36	POU012P	5P	82	26	-	42	8.5	6.5	9	3	002	○
M12X1.75	P4	12	12.12	POS014Q	5P	88	26	-	45	10.5	8	11	3	002	○
	P5(P4+20)	12	12.12	POT014Q	5P	88	26	-	45	10.5	8	11	3	002	○
M14X2	P4	14	14.12	POS016Q	5P	95	26	-	48	12.5	10	13	3	002	○
	P5(P4+20)	14	14.12	POT016Q	5P	95	26	-	48	12.5	10	13	3	002	○
	P6(P4+40)	14	14.12	POU016Q	5P	95	26	-	48	12.5	10	13	3	002	○
M16X2	P4	15.5	15.63	POS018R	5P	100	33	-	51	14	11	14	3	002	○
	P5(P4+20)	15.5	15.63	POT018R	5P	100	33	-	51	14	11	14	3	002	○
M18X2.5	P4	17.5	17.63	POS020R	5P	105	33	-	50	15	12	15	3	002	○
	P5(P4+20)	17.5	17.63	POT020R	5P	105	33	-	50	15	12	15	3	002	○
	P6(P4+40)	17.5	17.63	POU020R	5P	105	33	-	50	15	12	15	3	002	○
M20X2.5	P4	19.5	19.63	POS022R	5P	115	33	-	55	17	13	16	3	002	○
	P5(P4+20)	19.5	19.63	POT022R	5P	115	33	-	55	17	13	16	3	002	○
M22X2.5	P4	21	21.13	POS024S	5P	120	39	-	55	19	15	18	3	002	○
	P5(P4+20)	21	21.13	POT024S	5P	120	39	-	55	19	15	18	3	002	○
	P6(P4+40)	21	21.13	POU024S	5P	120	39	-	55	19	15	18	3	002	○
M24X3	P4	24	24.13	POS027S	5P	130	39	-	60	20	15	18	4	002	○
	P5	26.5	26.63	POT030T	5P	135	46	-	62	23	17	20	4	002	○
M30X3.5	P5	29.5	29.63	POMT033T	5P	145	46	-	67	25	19	22	4	002	○
	P5	32	32.12	POMT036U	5P	155	52	-	71	28	21	24	4	002	○
	P5	35	35.12	POMT039U	5P	165	52	-	76	30	23	26	4	002	○
M33X3.5	P5	37.5	37.63	POMT042V	5P	175	59	-	81	32	26	30	4	002	○
	P5	40.5	40.63	POMT045V	5P	180	59	-	83	35	26	30	4	002	○
M36X4	P5	43	43.12	POMT048W	5P	185	65	-	85	38	29	32	4	002	○
	P5	43	43.12	POMT048W	5P	185	65	-	85	38	29	32	4	002	○

ST

ROLL

CARBIDE

LONG

HAND TAPS

EG (STI)

MF	TCTR (tolerance)	\varnothing (mm)	Hole \varnothing (mm)	Code	THCHT (chamfer)	LF (mm)	THL (mm)	LU (mm)	LS (mm)	DCON (mm)	K (mm)	LK (mm)	NOF	Type	Stock
JIS															
M2X0.25	P1	1.75	1.77	POP2.0B	5P	42	4.5	12	27	3	2.5	5	3	001	○
	P2	1.95	1.97	POQ2.2B	5P	42	4.5	12	27	3	2.5	5	3	001	○
	P2	2.2	2.2	POQ2.5D	5P	46	6.3	14	29	3	2.5	5	3	001	○
M2.5X0.35	P2	2.3	2.3	POQ2.6D	5P	46	6.3	14	29	3	2.5	5	3	001	○
	P2	2.7	2.7	POQ3.0D	5P	46	6.5	14	26	4	3.2	6	3	001	○
M3X0.35	P2	3.2	3.2	POQ3.5D	5P	52	6.5	16	29	5	4	7	3	001	○
	P2	3.5	3.56	POQ4.0G	5P	52	9	17	29	5	4	7	3	001	○
M4X0.5	P2	4	4.06	POQ4.5G	5P	60	9	21	33	5.5	4.5	7	3	001	○
	P2	4.5	4.56	POQ5.0G	5P	60	9	22	33	5.5	4.5	7	3	001	○
M5X0.5	P2	5	5.06	POQ5.5G	5P	62	9	26	33	6	4.5	7	3	001	○
	P2	5.3	5.33	POQ6.0J	5P	62	15	26	33	6	4.5	7	3	001	○
M6X0.75	P3(P2+20)	5.3	5.33	POR6.0J	5P	62	15	26	33	6	4.5	7	3	001	○
	P2	5.5	5.56	POQ6.0G	5P	62	9	26	33	6	4.5	7	3	001	○

CENTER DRILLS

Technical info

MF	TCTR (tolerance)	∅ (mm)	Hole ∅ (mm)	Code	THCHT (chamfer)	LF (mm)	THL (mm)	LU (mm)	LS (mm)	DCON (mm)	K (mm)	LK (mm)	NOF	Type	Stock
JIS															
M7X0.75	P2	6.3	6.33	POQ7.0J	5P	70	19	-	36	6.2	5	8	3	002	○
	P3(P2+20)	6.3	6.33	POR7.0J	5P	70	19	-	36	6.2	5	8	3	002	○
M7X0.5	P2	6.5	6.56	POQ7.0G	5P	70	10	-	36	6.2	5	8	3	037	○
M8X1	P3	7	7.09	POR8.0M	5P	70	19	-	36	6.2	5	8	3	002	○
	P4(P3+20)	7	7.09	POS8.0M	5P	70	19	-	36	6.2	5	8	3	002	○
M8X0.75	P3	7.3	7.33	POR8.0J	5P	70	19	-	36	6.2	5	8	3	002	○
M8X0.5	P2	7.5	7.56	POQ8.0G	5P	70	10	-	36	6.2	5	8	3	037	○
M9X1	P3	8	8.09	POR9.0M	5P	75	23	-	38	7	5.5	8	3	002	○
M9X0.75	P3	8.3	8.33	POR9.0J	5P	75	13	-	38	7	5.5	8	3	037	○
M9X0.5	P2	8.5	8.56	POQ9.0G	5P	75	11	-	38	7	5.5	8	3	037	○
M10X1.25	P3	8.8	8.85	POR010N	5P	75	23	-	38	7	5.5	8	3	002	○
	P4(P3+20)	8.8	8.85	POS010N	5P	75	23	-	38	7	5.5	8	3	002	○
M10X1	P3	9	9.09	POR010M	5P	75	23	-	38	7	5.5	8	3	002	○
	P4(P3+20)	9	9.09	POS010M	5P	75	23	-	38	7	5.5	8	3	002	○
M10X0.75	P3	9.3	9.33	POR010J	5P	75	13	-	38	7	5.5	8	3	037	○
M10X0.5	P2	9.5	9.56	POQ010G	5P	75	11	-	38	7	5.5	8	3	037	○
M11X1.25	P3	9.8	9.85	POR011N	5P	82	26	-	42	8.5	6.5	9	3	002	○
M11X1	P3	10	10.1	POR011M	5P	82	26	-	42	8.5	6.5	9	3	002	○
M11X0.75	P3	10.3	10.33	POR011J	5P	82	14	-	42	8.5	6.5	9	3	037	○
M11X0.5	P2	10.5	10.56	POQ011G	5P	82	12	-	42	8.5	6.5	9	3	037	○
M12X1.5	P3	10.5	10.6	POR0120	5P	82	26	-	42	8.5	6.5	9	3	002	○
	P4(P3+20)	10.5	10.6	POS0120	5P	82	26	-	42	8.5	6.5	9	3	002	○
	P5(P3+40)	10.5	10.6	POT0120	5P	82	26	-	42	8.5	6.5	9	3	002	○
M12X1.25	P4	10.8	10.85	POS012N	5P	82	26	-	42	8.5	6.5	9	3	002	○
	P5(P4+20)	10.8	10.85	POT012N	5P	82	26	-	42	8.5	6.5	9	3	002	○
M12X1	P3	11	11.09	POR012M	5P	82	26	-	42	8.5	6.5	9	3	002	○
	P4(P3+20)	11	11.09	POS012M	5P	82	26	-	42	8.5	6.5	9	3	002	○
M12X0.75	P3	11.3	11.33	POR012J	5P	82	14	-	42	8.5	6.5	9	3	037	○
M12X0.5	P2	11.5	11.56	POQ012G	5P	82	12	-	42	8.5	6.5	9	3	037	○
M13X1.75	P4	11.3	11.4	POS013P	5P	88	26	-	45	10.5	8	11	3	002	○
M13X1.5	P3	11.6	11.6	POR0130	5P	88	26	-	45	10.5	8	11	3	002	○
M13X1	P3	12	12.09	POR013M	5P	88	26	-	45	10.5	8	11	3	002	○
M13X0.75	P3	12.3	12.33	POR013J	5P	88	14	-	45	10.5	8	11	3	037	○
M13X0.5	P2	12.5	12.56	POQ013G	5P	88	12	-	45	10.5	8	11	3	037	○
M14X1.5	P3	12.5	12.6	POR0140	5P	88	26	-	45	10.5	8	11	3	002	○
	P4(P3+20)	12.5	12.6	POS0140	5P	88	26	-	45	10.5	8	11	3	002	○
	P5(P3+40)	12.5	12.6	POT0140	5P	88	26	-	45	10.5	8	11	3	002	○
M14X1.25	P3	12.8	12.85	POR014N	5P	88	26	-	45	10.5	8	11	3	002	○
M14X1	P3	13	13.09	POR014M	5P	88	26	-	45	10.5	8	11	3	002	○
	P4(P3+20)	13	13.09	POS014M	5P	88	26	-	45	10.5	8	11	3	002	○
M14X0.75	P3	13.3	13.33	POR014J	5P	88	15	-	45	10.5	8	11	3	037	○
M14X0.5	P2	13.5	13.56	POQ014G	5P	88	12	-	45	10.5	8	11	3	037	○
M15X2	P4	13	13.12	POS015Q	5P	95	26	-	48	12.5	10	13	3	002	○
M15X1.5	P3	13.5	13.6	POR0150	5P	95	26	-	48	12.5	10	13	3	002	○
M15X1	P3	14	14.09	POR015M	5P	95	26	-	48	12.5	10	13	3	002	○

Intro

SP

SL

PO

JIS

ST

ROLL

CARBIDE

LONG

HAND
TAPS

EG (STI)

SPECIAL
THREADS,
GAUGESTHREAD
MILLS

DIES

CENTER
DRILLSTechnical
info

Spiral Pointed Taps

Intro

	MF	TCTR (tolerance)	\varnothing (mm)	Hole \varnothing (mm)	Code	THCHT (chamfer)	LF (mm)	THL (mm)	LU (mm)	LS (mm)	DCON (mm)	K (mm)	LK (mm)	NOF	Type	Stock
	JIS															
SP	M16X1.5	P3	14.5	14.6	POR0160	5P	95	26	-	48	12.5	10	13	3	002	○
		P4(P3+20)	14.5	14.6	POS0160	5P	95	26	-	48	12.5	10	13	3	002	○
		P5(P3+40)	14.5	14.6	POT0160	5P	95	26	-	48	12.5	10	13	3	002	○
	M16X1.25	P3	14.8	14.85	POR016N	5P	95	26	-	48	12.5	10	13	3	002	○
SL	M16X1	P3	15	15.09	POR016M	5P	95	26	-	48	12.5	10	13	3	002	○
	M17X1.5	P4	15.5	15.6	POS0170	5P	100	33	-	51	14	11	14	3	002	○
	M17X1	P4	16	16.09	POS017M	5P	100	18	-	51	14	11	14	3	037	○
	M18X2	P4	16	16.12	POS018Q	5P	100	33	-	51	14	11	14	3	002	○
PO	M18X1.5	P4	16.5	16.6	POS0180	5P	100	33	-	51	14	11	14	3	002	○
		P5(P4+20)	16.5	16.6	POT0180	5P	100	33	-	51	14	11	14	3	002	○
JIS	M18X1.25	P3	16.8	16.85	POR018N	5P	100	33	-	51	14	11	14	3	002	○
	M18X1	P3	17	17.09	POR018M	5P	100	18	-	51	14	11	14	3	037	○
ST	M19X1.5	P4	17.5	17.6	POS0190	5P	105	33	-	50	15	12	15	3	002	○
	M19X1	P3	18	18.09	POR019M	5P	105	18	-	50	15	12	15	3	037	○
	M20X2	P4	18	18.12	POS020Q	5P	105	33	-	50	15	12	15	3	002	○
ROLL	M20X1.5	P4	18.5	18.6	POS0200	5P	105	33	-	50	15	12	15	3	002	○
		P5(P4+20)	18.5	18.6	POT0200	5P	105	33	-	50	15	12	15	3	002	○
	M20X1	P3	19	19.09	POR020M	5P	105	18	-	50	15	12	15	3	037	○
	M22X2	P4	20	20.12	POS022Q	5P	115	33	-	55	17	13	16	3	002	○
CARBIDE	M22X1.5	P4	20.5	20.6	POS0220	5P	115	33	-	55	17	13	16	3	002	○
		P5(P4+20)	20.5	20.6	POT0220	5P	115	33	-	55	17	13	16	3	002	○
	M22X1	P3	21	21.09	POR022M	5P	115	19	-	55	17	13	16	3	037	○
	M24X2	P4	22	22.12	POS024Q	5P	120	39	-	55	19	15	18	3	002	○
LONG	M24X1.5	P4	22.5	22.6	POS0240	5P	120	39	-	55	19	15	18	3	002	○
		P5(P4+20)	22.5	22.6	POT0240	5P	120	39	-	55	19	15	18	3	002	○
	M24X1	P3	23	23.09	POR024M	5P	120	19	-	55	19	15	18	3	037	○
HAND TAPS	M25X2	P4	23	23.12	POS025Q	5P	125	39	-	58	19	15	18	3	002	○
	M25X1.5	P4	23.5	23.6	POS0250	5P	125	39	-	58	19	15	18	3	002	○
	M25X1	P3	24	24.09	POR025M	5P	125	20	-	58	19	15	18	3	037	○
EG (STI)	M26X3	P4	23	23.12	POS026S	5P	130	39	-	60	20	15	18	4	002	○
	M26X2	P4	24	24.12	POS026Q	5P	130	39	-	60	20	15	18	4	002	○
	M26X1.5	P4	24.5	24.6	POS0260	5P	130	39	-	60	20	15	18	4	002	○
	M26X1	P3	25	25.09	POR026M	5P	130	20	-	60	20	15	18	4	037	○
SPECIAL THREADS, GAUGES	M27X2	P4	25	25.12	POS027Q	5P	130	39	-	60	20	15	18	4	002	○
	M27X1.5	P4	25.5	25.6	POS0270	5P	130	39	-	60	20	15	18	4	002	○
	M27X1	P3	26	26.09	POR027M	5P	130	20	-	60	20	15	18	4	037	○
	M28X2	P4	26	26.12	POS028Q	5P	135	46	-	62	23	17	20	4	002	○
THREAD MILLS	M28X1.5	P4	26.5	26.6	POS0280	5P	135	46	-	62	23	17	20	4	002	○
		P3	27	27.09	POR028M	5P	135	20	-	62	23	17	20	4	037	○
	M28X1	P3	27	27.09	POR028M	5P	135	20	-	62	23	17	20	4	037	○
	M30X3	P4	27	27.13	POS030S	5P	135	46	-	62	23	17	20	4	002	○
DIES	M30X2	P4	28	28.12	POS030Q	5P	135	46	-	62	23	17	20	4	002	○
		P4	28.5	28.6	POS0300	5P	135	46	-	62	23	17	20	4	002	○
	M30X1	P3	29	29.09	POR030M	5P	135	21	-	62	23	17	20	4	037	○
	M32X3	P4	29	29.13	POMS032S	5P	145	46	-	67	24	19	22	4	002	○
CENTER DRILLS	M32X2	P4	30	30.12	POMS032Q	5P	145	46	-	67	24	19	22	4	002	○
		P4	30.5	30.6	POMS0320	5P	145	46	-	67	24	19	22	4	002	○
	M33X3	P4	30	30.13	POMS033S	5P	145	46	-	67	25	19	22	4	002	○

Technical
info

MF	TCTR (tolerance)	\varnothing (mm)	Hole \varnothing (mm)	Code	THCHT (chamfer)	LF (mm)	THL (mm)	LU (mm)	LS (mm)	DCON (mm)	K (mm)	LK (mm)	NOF	Type	Stock
JIS															
M33X2	P4	31	31.12	POMS033Q	5P	145	46	-	67	25	19	22	4	002	○
M33X1.5	P4	31.5	31.6	POMS0330	5P	145	46	-	67	25	19	22	4	002	○
M34X2	P4	32	32.12	POMS034Q	5P	155	52	-	71	28	21	24	4	002	○
M34X1.5	P4	35.5	32.6	POMS0340	5P	155	26	-	71	28	21	24	4	037	○
M35X2	P4	33	33.12	POMS035Q	5P	155	52	-	71	28	21	24	4	002	○
M35X1.5	P4	33.5	33.6	POMS0350	5P	155	26	-	71	28	21	24	4	037	○
M36X3	P4	33	33.13	POMS036S	5P	155	52	-	71	28	21	24	4	002	○
M36X2	P4	34	34.12	POMS036Q	5P	155	52	-	71	28	21	24	4	002	○
M36X1.5	P4	34.5	34.6	POMS0360	5P	155	26	-	71	28	21	24	4	037	○
M38X2	P4	36	36.12	POMS038Q	5P	165	52	-	76	30	23	26	4	002	○
M38X1.5	P4	36.5	36.6	POMS0380	5P	165	26	-	76	30	23	26	4	037	○
M39X3	P4	36	36.13	POMS039S	5P	165	52	-	76	30	23	26	4	002	○
M39X2	P4	37	37.12	POMS039Q	5P	165	52	-	76	30	23	26	4	002	○
M39X1.5	P4	37.5	37.6	POMS0390	5P	165	26	-	76	30	23	26	4	037	○
M40X3	P4	37	37.13	POMS040S	5P	175	59	-	81	32	26	30	4	002	○
M40X2	P4	38	38.12	POMS040Q	5P	175	59	-	81	32	26	30	4	002	○
M40X1.5	P4	38.5	38.6	POMS0400	5P	175	27	-	81	32	26	30	4	037	○
M42X3	P4	39	39.13	POMS042S	5P	175	59	-	81	32	26	30	4	002	○
M42X2	P4	40	40.12	POMS042Q	5P	175	59	-	81	32	26	30	4	002	○
M42X1.5	P4	40.5	40.6	POMS0420	5P	175	27	-	81	32	26	30	4	037	○
M45X3	P4	42	42.13	POMS045S	5P	180	59	-	83	35	26	30	4	002	○
M45X2	P4	43	43.12	POMS045Q	5P	180	59	-	83	35	26	30	4	002	○
M45X1.5	P4	43.5	43.6	POMS0450	5P	180	27	-	83	35	26	30	4	037	○
M48X3	P4	45	45.13	POMS048S	5P	185	65	-	85	38	29	32	4	002	○
M48X2	P4	46	46.12	POMS048Q	5P	185	65	-	85	38	29	32	4	002	○
M48X1.5	P4	46.5	46.6	POMS0480	5P	185	28	-	85	38	29	32	4	037	○
M50X1.5	P4	48.5	48.6	POS0500	5P	145	45	-	81	40	32	35	4	002	○
UNC															
UNC	TCTR (tolerance)	\varnothing (mm)	Hole \varnothing (mm)	Code	THCHT (chamfer)	LF (mm)	THL (mm)	LU (mm)	LS (mm)	DCON (mm)	K (mm)	LK (mm)	NOF	Type	Stock
JIS															
No.1-64UNC	P1	1.54	1.55	POPUN1D	5P	42	7.2	-	27	3	2.5	5	2	005	○
No.2-56UNC	P1	1.8	1.83	POPUN2E	5P	42	8.1	12	27	3	2.5	5	3	001	○
No.3-48UNC	P1	2.09	2.1	POPUN3F	5P	46	8.1	14	29	3	2.5	5	3	001	○
No.4-40UNC	P2	2.3	2.33	POQUN4H	5P	46	9	14	26	4	3.2	6	3	001	○
No.5-40UNC	P2	2.6	2.64	POQUN5H	5P	52	11	16	29	5	4	7	3	001	○
No.6-32UNC	P2	2.8	2.83	POQUN6J	5P	52	11	16	29	5	4	7	3	001	○
No.8-32UNC	P2	3.4	3.47	POQUN8J	5P	60	13	21	33	5.5	4.5	7	3	001	○
No.10-24UNC	P2	3.89	3.9	POQUNAM	5P	60	13	22	33	5.5	4.5	7	3	001	○
No.12-24UNC	P2	4.5	4.53	POQUNCM	5P	62	15	26	33	6	4.5	7	3	001	○
1/4-20UNC	P2	5.1	5.19	POQU04N	5P	62	15	26	33	6	4.5	7	3	001	○
5/16-18UNC	P3	6.6	6.65	PORU050	5P	70	19	-	36	6.2	5	8	3	002	○
3/8-16UNC	P3	8	8.07	PORU06P	5P	75	23	-	38	7	5.5	8	3	002	○
7/16-14UNC	P3	9.4	9.45	PORU07Q	5P	82	26	-	42	8.5	6.5	9	3	002	○
1/2-13UNC	P3	10.9	10.91	PORU08R	5P	88	26	-	45	10.5	8	11	3	002	○
9/16-12UNC	P3	12.2	12.33	PORU09S	5P	95	26	-	48	12.5	10	13	3	002	○
5/8-11UNC	P3	13.6	13.75	PORU10U	5P	95	26	-	48	12.5	10	13	3	002	○
3/4-10UNC	P4	16.6	16.7	POSU12V	5P	105	33	-	50	15	12	15	3	002	○

Intro

SP

SL

PO

JIS

ST

ROLL

CARBIDE

LONG

HAND
TAPS

EG (STI)

SPECIAL
THREADS,
GAUGESTHREAD
MILLS

DIES

CENTER
DRILLSTechnical
info

Spiral Pointed Taps

Intro

	UNC	TCTR (tolerance)	\varnothing (mm)	Hole \varnothing (mm)	Code	THCHT (chamfer)	LF (mm)	THL (mm)	LU (mm)	LS (mm)	DCON (mm)	K (mm)	LK (mm)	NOF	Type	Stock
	JIS															
	7/8-9UNC	P4	19.6	19.61	POSU14W	5P	115	33	-	55	17	13	16	3	002	○
SP	1-8UNC	P4	22.3	22.45	POSU16X	5P	125	39	-	58	19	15	18	3	002	○
	1 1/8-7UNC	P4	25	25.17	POSU18Y	5P	135	46	-	62	23	17	20	4	002	○
	1 1/4-7UNC	P4	28.2	28.35	POMSU20Y	5P	145	46	-	67	24	19	22	4	002	○
SL	1 3/8-6UNC	P5	30.8	30.92	POMTU22Z	5P	155	52	-	71	28	21	24	4	002	○
	1 1/2-6UNC	P5	34	34.1	POMTU24Z	5P	165	52	-	76	30	23	26	4	002	○

PO

JIS

	UNF	TCTR (tolerance)	\varnothing (mm)	Hole \varnothing (mm)	Code	THCHT (chamfer)	LF (mm)	THL (mm)	LU (mm)	LS (mm)	DCON (mm)	K (mm)	LK (mm)	NOF	Type	Stock
	JIS															
	No.0-80UNF	P1	1.25	1.27	POPUN0B	5P	36	6.3	-	24	3	2.5	5	2	005	○
	No.1-72UNF	P1	1.55	1.58	POPUN1C	5P	42	7.2	-	27	3	2.5	5	2	005	○
	No.2-64UNF	P1	1.85	1.87	POPUN2D	5P	42	8.1	12	27	3	2.5	5	3	001	○
ST	No.3-56UNF	P1	2.1	2.15	POPUN3E	5P	46	8.1	14	29	3	2.5	5	3	001	○
	No.4-48UNF	P1	2.4	2.41	POPUN4F	5P	46	9	14	26	4	3.2	6	3	001	○
	No.5-44UNF	P1	2.7	2.69	POPUN5G	5P	52	11	16	29	5	4	7	3	001	○
ROLL	No.6-40UNF	P2	2.9	2.97	POQUN6H	5P	52	11	16	29	5	4	7	3	001	○
	No.8-36UNF	P2	3.5	3.55	POQUN8I	5P	60	13	21	33	5.5	4.5	7	3	001	○
	No.10-32UNF	P2	4.1	4.12	POQUNAJ	5P	60	13	22	33	5.5	4.5	7	3	001	○
CARBIDE	No.12-28UNF	P2	4.6	4.67	POQUNCK	5P	62	15	26	33	6	4.5	7	3	001	○
	1/4-28UNF	P2	5.5	5.53	POQU04K	5P	62	15	26	33	6	4.5	7	3	001	○
	5/16-24UNF	P2	6.9	6.97	POQU05M	5P	70	19	-	36	6.2	5	8	3	002	○
	3/8-24UNF	P2	8.5	8.57	POQU06M	5P	75	23	-	38	7	5.5	8	3	002	○
	7/16-20UNF	P3	9.9	9.96	PORU07N	5P	82	26	-	42	8.5	6.5	9	3	002	○
LONG	1/2-20UNF	P3	11.5	11.54	PORU08N	5P	88	26	-	45	10.5	8	11	3	002	○
	9/16-18UNF	P3	12.9	13	PORU09O	5P	95	26	-	48	12.5	10	13	3	002	○
	5/8-18UNF	P3	14.5	14.6	PORU10O	5P	95	26	-	48	12.5	10	13	3	002	○
HAND TAPS	3/4-16UNF	P3	17.5	17.59	PORU12P	5P	105	33	-	50	15	12	15	3	002	○
	7/8-14UNF	P3	20.5	20.57	PORU14Q	5P	115	33	-	55	17	13	16	3	002	○
	1-12UNF	P4	23.3	23.46	POSU16S	5P	125	39	-	58	19	15	18	3	002	○
	1 1/8-12UNF	P4	26.5	26.63	POSU18S	5P	135	46	-	62	23	17	20	4	002	○
EG (STI)	1 1/4-12UNF	P4	29.6	29.81	POMSU20S	5P	145	46	-	67	24	19	22	4	002	○
	1 3/8-12UNF	P4	32.8	32.98	POMSU22S	5P	155	52	-	71	28	21	24	4	002	○
	1 1/2-12UNF	P4	36	36.16	POMSU24S	5P	165	52	-	76	30	23	26	4	002	○

SPECIAL
THREADS,
GAUGES

	UNS	TCTR (tolerance)	\varnothing (mm)	Hole \varnothing (mm)	Code	THCHT (chamfer)	LF (mm)	THL (mm)	LU (mm)	LS (mm)	DCON (mm)	K (mm)	LK (mm)	NOF	Type	Stock
	JIS															
	1-14UNS	P4	23.6	23.7	POSU16Q	5P	125	39	-	58	19	15	18	3	002	○

THREAD
MILLS

	UNEF	TCTR (tolerance)	\varnothing (mm)	Hole \varnothing (mm)	Code	THCHT (chamfer)	LF (mm)	THL (mm)	LU (mm)	LS (mm)	DCON (mm)	K (mm)	LK (mm)	NOF	Type	Stock
	JIS															
	1/4-32UNEF	P2	5.6	5.64	POQU04J	5P	62	15	26	33	6	4.5	7	3	001	○
DIES	5/16-32UNEF	P2	7.1	7.22	POQU05J	5P	70	19	-	36	6.2	5	8	3	002	○
	3/8-32UNEF	P2	8.7	8.81	POQU06J	5P	75	13	-	38	7	5.5	8	3	037	○
	7/16-28UNEF	P2	10.2	10.29	POQU07K	5P	82	26	-	42	8.5	6.5	9	3	002	○
CENTER DRILLS	1/2-28UNEF	P2	11.8	11.88	POQU08K	5P	88	26	-	45	10.5	8	11	3	002	○
	5/8-24UNEF	P3	14.8	14.92	PORU10M	5P	95	26	-	48	12.5	10	13	3	002	○
	3/4-20UNEF	P3	17.8	17.89	PORU12N	5P	105	33	-	50	15	12	15	3	002	○

Technical
info

BSW	TCTR (tolerance)	∅ (mm)	Hole ∅ (mm)	Code	THCHT (chamfer)	LF (mm)	THL (mm)	LU (mm)	LS (mm)	DCON (mm)	K (mm)	LK (mm)	NOF	Type	Stock
JIS															
1/8W40	P2	2.55	2.56	POQW02H	5P	52	11	17	29	5	4	7	3	001	○
5/32W32	P2	3.15	3.2	POQW2HJ	5P	52	11	17	29	5	4	7	3	001	○
3/16W24	P2	3.7	3.7	POQW03M	5P	60	13	21	33	5.5	4.5	7	3	001	○
7/32W24	P2	4.5	4.52	POQW3HM	5P	62	15	26	33	6	4.5	7	3	001	○
1/4W20	P3	5.1	5.13	PORW04N	5P	62	15	26	33	6	4.5	7	3	001	○
5/16W18	P3	6.5	6.59	PORW05O	5P	70	19	-	36	6.2	5	8	3	002	○
3/8W16	P3	8	8.02	PORW06P	5P	75	23	-	38	7	5.5	8	3	002	○
7/16W14	P3	9.3	9.39	PORW07Q	5P	82	26	-	42	8.5	6.5	9	3	002	○
1/2W12	P3	10.6	10.7	PORW08S	5P	88	26	-	45	10.5	8	11	3	002	○
9/16W12	P3	12.25	12.29	PORW09S	5P	95	26	-	48	12.5	10	13	3	002	○
5/8W11	P3	13.5	13.68	PORW10U	5P	95	26	-	48	12.5	10	13	3	002	○
3/4W10	P4	16.5	16.63	POSW12V	5P	105	33	-	50	15	12	15	3	002	○
7/8W9	P4	19.5	19.53	POSW14W	5P	115	33	-	55	17	13	16	3	002	○
1 W8	P4	22.2	22.34	POSW16X	5P	125	39	-	58	19	15	18	3	002	○
1 1/8W7	P4	24.75	25.04	POSW18Y	5P	135	46	-	62	23	17	20	4	002	○
1 1/4W7	P4	28	28.21	POMSW20Y	5P	145	46	-	67	24	19	22	4	002	○
1 3/8W6	P5	30.5	30.72	POMTW22Z	5P	155	52	-	71	28	21	24	4	002	○
1 1/2W6	P5	33.75	33.9	POMTW24Z	5P	165	52	-	76	30	23	26	4	002	○
2 W4 1/2	P5	45	45.15	POTW329	5P	195	70	-	85	40	32	35	4	002	○

Intro

SP

SL

PO

JIS

ST

ROLL

CARBIDE

LONG

HAND
TAPS

EG (STI)

SPECIAL
THREADS,
GAUGESTHREAD
MILLS

DIES

CENTER
DRILLSTechnical
info

Intro

PO LH

GP General Purpose Series

Spiral Pointed Taps for Left Hand Threads



SP

SL



FEATURES

General purpose for through hole application.

For steel application at medium-low cutting speed, also suitable for non-ferrous materials.

For left hand threads.

PO

Recommended Tapping Speeds Depending On Materials

ISO	Vc (m/min)	ISO	Vc (m/min)
P1	5÷10 ☆	N1	5÷10 ☆
P2	5÷10 ★	N2	5÷10 ☆
P3	5÷10 ☆	N3	5÷10 ☆
P4	5÷8 ☆	N4	5÷10 ☆

★ 1st choice ☆ suitable

JIS

ST

ROLL

CARBIDE

LONG

HAND TAPS

EG (STI)

SPECIAL THREADS, GAUGES

THREAD MILLS



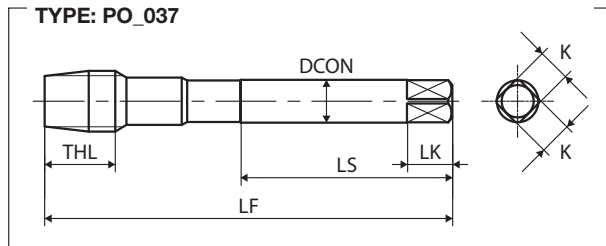
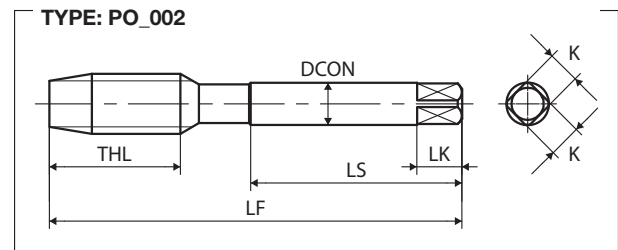
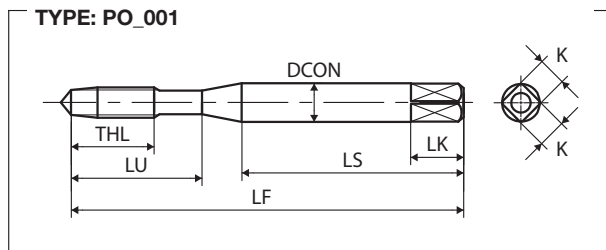

DIES

CENTER DRILLS

Technical info



M	TCTR (tolerance)	\varnothing (mm)	Hole \varnothing (mm)	Code	THCHT (chamfer)	LF (mm)	THL (mm)	LU (mm)	LS (mm)	DCON (mm)	K (mm)	LK (mm)	NOF	Type	Stock
JIS															
M3X0.5	P2	2.5	2.56	POQ3.0G--L	5P	46	9	14	26	4	3.2	6	3	001	○
M4X0.7	P2	3.3	3.38	POQ4.0I--L	5P	52	11	17	29	5	4	7	3	001	○
M5X0.8	P2	4.2	4.28	POQ5.0K--L	5P	60	13	22	33	5.5	4.5	7	3	001	○
M6X1	P2	5	5.09	POQ6.0M--L	5P	62	15	26	33	6	4.5	7	3	001	○
M8X1.25	P3	6.8	6.85	POR8.0N--L	5P	70	19	-	36	6.2	5	8	3	002	○
M10X1.5	P3	8.5	8.6	POR0100--L	5P	75	23	-	38	7	5.5	8	3	002	○
M12X1.75	P4	10.3	10.36	POS012P--L	5P	82	26	-	42	8.5	6.5	9	3	002	○
M14X2	P4	12	12.12	POS014Q--L	5P	88	26	-	45	10.5	8	11	3	002	○
M16X2	P4	14	14.12	POS016Q--L	5P	95	26	-	48	12.5	10	13	3	002	○

M	TCTR (tolerance)	 Hole Ø (mm)	Hole Ø (mm)	Code	THCHT (chamfer)	LF (mm)	THL (mm)	LU (mm)	LS (mm)	DCON (mm)	K (mm)	LK (mm)	NOF	Type	Stock
JIS															
M18X2.5	P4	15.5	15.63	POS018R--L	5P	100	33	-	51	14	11	14	3	002	○
M20X2.5	P4	17.5	17.63	POS020R--L	5P	105	33	-	50	15	12	15	3	002	○
M22X2.5	P4	19.5	19.63	POS022R--L	5P	115	33	-	55	17	13	16	3	002	○
M24X3	P4	21	21.13	POS024S--L	5P	120	39	-	55	19	15	18	3	002	○
M27X3	P4	24	24.13	POS027S--L	5P	130	39	-	60	20	15	18	4	002	○
M30X3.5	P5	26.5	26.63	POT030T--L	5P	135	46	-	62	23	17	20	4	002	○
MF	TCTR (tolerance)	 Hole Ø (mm)	Hole Ø (mm)	Code	THCHT (chamfer)	LF (mm)	THL (mm)	LU (mm)	LS (mm)	DCON (mm)	K (mm)	LK (mm)	NOF	Type	Stock
JIS															
M8X1	P3	7	7.09	POR8.0M--L	5P	70	19	-	36	6.2	5	8	3	002	○
M10X1.25	P3	8.8	8.85	POR010N--L	5P	75	23	-	38	7	5.5	8	3	002	○
M10X1	P3	9	9.09	POR010M--L	5P	75	23	-	38	7	5.5	8	3	002	○
M12X1.5	P3	10.5	10.6	POR0120--L	5P	82	26	-	42	8.5	6.5	9	3	002	○
M12X1.25	P4	10.8	10.85	POS012N--L	5P	82	26	-	42	8.5	6.5	9	3	002	○
M12X1	P3	11	11.09	POR012M--L	5P	82	26	-	42	8.5	6.5	9	3	002	○
M14X1.5	P3	12.5	12.6	POR0140--L	5P	88	26	-	45	10.5	8	11	3	002	○
M16X1.5	P3	14.5	14.6	POR0160--L	5P	95	26	-	48	12.5	10	13	3	002	○
M18X1.5	P4	16.5	16.6	POS0180--L	5P	100	33	-	51	14	11	14	3	002	○
M20X1.5	P4	18.5	18.6	POS0200--L	5P	105	33	-	50	15	12	15	3	002	○
M20X1	P3	19	19.09	POR020M--L	5P	105	33	-	50	15	12	15	3	037	○
M22X1.5	P4	20.5	20.6	POS0220--L	5P	115	33	-	55	17	13	16	3	002	○
M24X1.5	P4	22.5	22.6	POS0240--L	5P	120	39	-	55	19	15	18	3	002	○
M27X1.5	P4	25.5	25.6	POS0270--L	5P	130	39	-	60	20	15	18	4	002	○
M30X1.5	P4	28.5	28.6	POS0300--L	5P	135	46	-	62	23	17	20	4	002	○
UNC	TCTR (tolerance)	 Hole Ø (mm)	Hole Ø (mm)	Code	THCHT (chamfer)	LF (mm)	THL (mm)	LU (mm)	LS (mm)	DCON (mm)	K (mm)	LK (mm)	NOF	Type	Stock
JIS															
1/4-20UNC	P2	5.1	5.19	POQU04N--L	5P	62	15	26	33	6	4.5	7	3	001	○
5/16-18UNC	P3	6.6	6.65	PORU050--L	5P	70	19	-	36	6.2	5	8	3	002	○
3/8-16UNC	P3	8	8.07	PORU06P--L	5P	75	23	-	38	7	5.5	8	3	002	○
7/16-14UNC	P3	9.4	9.45	PORU07Q--L	5P	82	26	-	42	8.5	6.5	9	3	002	○
1/2-13UNC	P3	10.9	10.91	PORU08R--L	5P	88	26	-	45	10.5	8	11	3	002	○
UNF	TCTR (tolerance)	 Hole Ø (mm)	Hole Ø (mm)	Code	THCHT (chamfer)	LF (mm)	THL (mm)	LU (mm)	LS (mm)	DCON (mm)	K (mm)	LK (mm)	NOF	Type	Stock
JIS															
1/4-28UNF	P2	5.5	5.53	POQU04K--L	5P	62	15	26	33	6	4.5	7	3	001	○
5/16-24UNF	P2	6.9	6.97	POQU05M--L	5P	70	19	-	36	6.2	5	8	3	002	○
3/8-24UNF	P2	8.5	8.57	POQU06M--L	5P	75	23	-	38	7	5.5	8	3	002	○
7/16-20UNF	P3	9.9	9.96	PORU07N--L	5P	82	26	-	42	8.5	6.5	9	3	002	○
1/2-20UNF	P3	11.5	11.54	PORU08N--L	5P	88	26	-	45	10.5	8	11	3	002	○
BSW	TCTR (tolerance)	 Hole Ø (mm)	Hole Ø (mm)	Code	THCHT (chamfer)	LF (mm)	THL (mm)	LU (mm)	LS (mm)	DCON (mm)	K (mm)	LK (mm)	NOF	Type	Stock
JIS															
1/4W20	P3	5.1	5.13	PORW04N--L	5P	62	15	26	33	6	4.5	7	3	001	○
5/16W18	P3	6.5	6.59	PORW050--L	5P	70	19	-	36	6.2	5	8	3	002	○
3/8W16	P3	8	8.02	PORW06P--L	5P	75	23	-	38	7	5.5	8	3	002	○
1/2W12	P3	10.6	10.7	PORW08S--L	5P	88	26	-	45	10.5	8	11	3	002	○
5/8W11	P3	13.5	13.68	PORW10U--L	5P	95	26	-	48	12.5	10	13	3	002	○
3/4W10	P4	16.5	16.63	POSW12V--L	5P	105	33	-	50	15	12	15	3	002	○

Intro

SP

SL

PO

JIS

ST

ROLL

CARBIDE

LONG

HAND
TAPS

EG (STI)

SPECIAL
THREADS,
GAUGESTHREAD
MILLS

DIES

CENTER
DRILLSTechnical
info

Intro **SU+PO/SU-PO**



MS Material Specific Series

Spiral Pointed Taps for Stainless Steel



FEATURES

Material specific for through hole application.
Most suitable for stainless steel, steel and alloy steel.
OX treatment reduces welding troubles.

Recommended Tapping Speeds Depending On Materials

ISO	Vc (m/min)	★	ISO	Vc (m/min)	★
P1	≤10	★	M1	≤10	★
P2	≤10	★	M2	≤10	★
P3	≤10	★			
P4	≤10	☆			
P7	≤10	★			

★ 1st choice ☆ suitable

CARBIDE

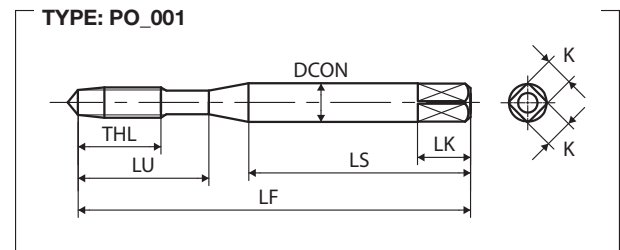
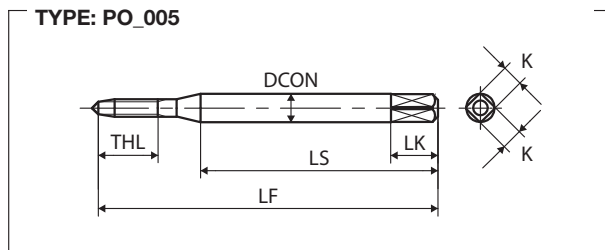

LONG

HAND TAPS

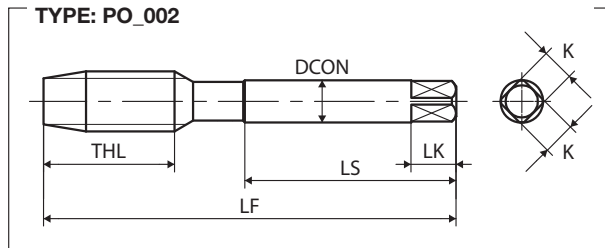

EG (STI)

SPECIAL THREADS, GAUGES

M	TCTR (tolerance)	∅ (mm)	Hole ∅ (mm)	Code	THCHT (chamfer)	LF (mm)	THL (mm)	LU (mm)	LS (mm)	DCON (mm)	K (mm)	LK (mm)	NOF	Type	Stock
JIS															
M1.4X0.3	P1	1.1	1.13	PUPP1.4C	5P	36	5.4	-	24	3	2.5	5	2	005	○
M1.6X0.35	P2	1.25	1.3	PUPQ1.6D	5P	36	6.3	-	24	3	2.5	5	2	005	○
M1.7X0.35	P2	1.35	1.4	PUPQ1.7D	5P	36	6.3	-	24	3	2.5	5	2	005	○
M2X0.4	P2	1.6	1.65	PUPQ2.0E	5P	42	7.2	12	27	3	2.5	5	2	001	○
	P3(P2+15)	1.6	1.65	PUPR2.0E	5P	42	7.2	12	27	3	2.5	5	2	001	○
M2.3X0.4	P2	1.9	1.95	PUPQ2.3E	5P	42	7.2	12	27	3	2.5	5	2	001	○
	P3(P2+15)	1.9	1.95	PUPR2.3E	5P	42	7.2	12	27	3	2.5	5	2	001	○
M2.5X0.45	P2	2.1	2.11	PUPQ2.5F	5P	46	8.1	14	29	3	2.5	5	2	001	○
	P3(P2+15)	2.1	2.11	PUPR2.5F	5P	46	8.1	14	29	3	2.5	5	2	001	○

Technical info

M	TCTR (tolerance)	\varnothing (mm)	Hole \varnothing (mm)	Code	THCHT (chamfer)	LF (mm)	THL (mm)	LU (mm)	LS (mm)	DCON (mm)	K (mm)	LK (mm)	NOF	Type	Stock	
JIS																Intro
M2.6X0.45	P2	2.2	2.21	PUPQ2.6F	5P	46	8.1	14	29	3	2.5	5	2	001	●	
	P3(P2+15)	2.2	2.21	PUPR2.6F	5P	46	8.1	14	29	3	2.5	5	2	001	○	SP
3M0.6	P2	2.45	2.47	PUMQ3.0H	5P	46	9	14	26	4	3.2	6	3	001	○	
M3X0.5	P2	2.5	2.56	PUMQ3.0G	5P	46	9	14	26	4	3.2	6	3	001	○	
	P3(P2+15)	2.5	2.56	PUMR3.0G	5P	46	9	14	26	4	3.2	6	3	001	○	SL
	P4(P2+30)	2.5	2.56	PUMS3.0G	5P	46	9	14	26	4	3.2	6	3	001	○	
M3.5X0.6	P2	2.9	2.97	PUMQ3.5H	5P	52	11	16	29	5	4	7	3	001	●	
4M0.75	P2	3.3	3.33	PUMQ4.0J	5P	52	11	17	29	5	4	7	3	001	○	
M4X0.7	P2	3.3	3.38	PUMQ4.0I	5P	52	11	17	29	5	4	7	3	001	○	PO
	P3(P2+20)	3.3	3.38	PUMR4.0I	5P	52	11	17	29	5	4	7	3	001	○	JIS
	P4(P2+40)	3.3	3.38	PUMS4.0I	5P	52	11	17	29	5	4	7	3	001	○	
5M0.9	P2	4.15	4.19	PUMQ5.0L	5P	60	13	22	33	5.5	4.5	7	3	001	○	
M5X0.8	P2	4.2	4.28	PUMQ5.0K	5P	60	13	22	33	5.5	4.5	7	3	001	○	ST
	P3(P2+20)	4.2	4.28	PUMR5.0K	5P	60	13	22	33	5.5	4.5	7	3	001	○	
	P4(P2+40)	4.2	4.28	PUMS5.0K	5P	60	13	22	33	5.5	4.5	7	3	001	○	
M6X1	P2	5	5.09	PUMQ6.0M	5P	62	15	26	33	6	4.5	7	3	001	○	ROLL
	P3(P2+20)	5	5.09	PUMR6.0M	5P	62	15	26	33	6	4.5	7	3	001	○	
	P4(P2+40)	5	5.09	PUMS6.0M	5P	62	15	26	33	6	4.5	7	3	001	○	
M7X1	P2	6	6.09	PUMQ7.0M	5P	70	19	-	36	6.2	5	8	3	002	○	
	P3	6.8	6.85	PUMR8.0N	5P	70	19	-	36	6.2	5	8	3	002	○	CARBIDE
M8X1.25	P4(P3+20)	6.8	6.85	PUMS8.0N	5P	70	19	-	36	6.2	5	8	3	002	○	
	P5(P3+40)	6.8	6.85	PUMT8.0N	5P	70	19	-	36	6.2	5	8	3	002	○	
M10X1.5	P3	8.5	8.6	PUMR0100	5P	75	23	-	38	7	5.5	8	3	002	○	LONG
	P4(P3+20)	8.5	8.6	PUMS0100	5P	75	23	-	38	7	5.5	8	3	002	○	
	P5(P3+40)	8.5	8.6	PUMT0100	5P	75	23	-	38	7	5.5	8	3	002	○	
M12X1.75	P4	10.3	10.36	PUMS012P	5P	82	26	-	42	8.5	6.5	9	3	002	○	
	P5(P4+20)	10.3	10.36	PUMT012P	5P	82	26	-	42	8.5	6.5	9	3	002	○	HAND TAPS
M14X2	P4	12	12.12	PUMS014Q	5P	88	26	-	45	10.5	8	11	3	002	○	
	P5(P4+20)	12	12.12	PUMT014Q	5P	88	26	-	45	10.5	8	11	3	002	○	
M16X2	P4	14	14.12	PUMS016Q	5P	95	26	-	48	12.5	10	13	3	002	○	EG (STI)
	P5(P4+20)	14	14.12	PUMT016Q	5P	95	26	-	48	12.5	10	13	3	002	○	
	P6(P4+40)	14	14.12	PUMU016Q	5P	95	26	-	48	12.5	10	13	3	002	○	
M18X2.5	P4	15.5	15.63	PUMS018R	5P	100	33	-	51	14	11	14	3	002	○	SPECIAL THREADS, GAUGES
	P5(P4+20)	15.5	15.63	PUMT018R	5P	100	33	-	51	14	11	14	3	002	○	
	P6(P4+40)	15.5	15.63	PUMU018R	5P	100	33	-	51	14	11	14	3	002	○	
M20X2.5	P4	17.5	17.63	PUMS020R	5P	105	33	-	50	15	12	15	3	002	○	THREAD MILLS
	P5(P4+20)	17.5	17.63	PUMT020R	5P	105	33	-	50	15	12	15	3	002	○	
	P6(P4+40)	17.5	17.63	PUMU020R	5P	105	33	-	50	15	12	15	3	002	○	
M22X2.5	P4	19.5	19.63	PUMS022R	5P	115	33	-	55	17	13	16	3	002	○	
	P5(P4+20)	19.5	19.63	PUMT022R	5P	115	33	-	55	17	13	16	3	002	○	
	P6(P4+40)	19.5	19.63	PUMU022R	5P	115	33	-	55	17	13	16	3	002	○	
M24X3	P4	21	21.13	PUMS024S	5P	120	39	-	55	19	15	18	3	002	○	DIES
	P5(P4+20)	21	21.13	PUMT024S	5P	120	39	-	55	19	15	18	3	002	○	
	P6(P4+40)	21	21.13	PUMU024S	5P	120	39	-	55	19	15	18	3	002	○	
M27X3	P4	24	24.13	PUMS027S	5P	130	39	-	60	20	15	18	4	002	○	CENTER DRILLS
M30X3.5	P5	26.5	26.63	PUMT030T	5P	135	46	-	62	23	17	20	4	002	○	
M33X3.5	P5	29.5	29.63	PUMT033T	5P	145	46	-	67	25	19	22	4	002	○	

Technical info

Spiral Pointed Taps

Intro

M	TCTR (tolerance)	 Hole Ø (mm)	Hole Ø (mm)	Code	THCHT (chamfer)	LF (mm)	THL (mm)	LU (mm)	LS (mm)	DCON (mm)	K (mm)	LK (mm)	NOF	Type	Stock
---	---------------------	--	----------------	------	--------------------	------------	-------------	------------	------------	--------------	-----------	------------	-----	------	-------

SP

JIS															
M36X4	P5	32	32.12	PUMT036U	5P	155	52	-	71	28	21	24	4	002	○
M39X4	P5	35	35.12	PUMT039U	5P	165	52	-	76	30	23	26	4	002	○
M42X4.5	P5	37.5	37.63	PUMT042V	5P	175	59	-	81	32	26	30	4	002	○

SL

MF	TCTR (tolerance)	 Hole Ø (mm)	Hole Ø (mm)	Code	THCHT (chamfer)	LF (mm)	THL (mm)	LU (mm)	LS (mm)	DCON (mm)	K (mm)	LK (mm)	NOF	Type	Stock
----	---------------------	--	----------------	------	--------------------	------------	-------------	------------	------------	--------------	-----------	------------	-----	------	-------

PO

JIS

JIS															
M6X0.75	P2	5.3	5.33	PUMQ6.0J	5P	62	15	26	33	6	4.5	7	3	001	○
M8X1	P3	7	7.09	PUMR8.0M	5P	70	19	-	36	6.2	5	8	3	002	○
M10X1.25	P3	8.8	8.85	PUMR010N	5P	75	23	-	38	7	5.5	8	3	002	○
	P4(P3+20)	8.8	8.85	PUMS010N	5P	75	23	-	38	7	5.5	8	3	002	○
M10X1	P3	9	9.09	PUMR010M	5P	75	23	-	38	7	5.5	8	3	002	○

ST

M12X1.5	P3	10.5	10.6	PUMR0120	5P	82	26	-	42	8.5	6.5	9	3	002	○
	P5(P3+40)	10.5	10.6	PUMT0120	5P	82	26	-	42	8.5	6.5	9	3	002	○
M12X1.25	P4	10.8	10.85	PUMS012N	5P	82	26	-	42	8.5	6.5	9	3	002	○
	P5(P4+20)	10.8	10.85	PUMT012N	5P	82	26	-	42	8.5	6.5	9	3	002	○

ROLL

M12X1	P3	11	11.09	PUMR012M	5P	82	26	-	42	8.5	6.5	9	3	002	○
M14X1.5	P3	12.5	12.6	PUMR0140	5P	88	26	-	45	10.5	8	11	3	002	○
	P5(P3+40)	12.5	12.6	PUMT0140	5P	88	26	-	45	10.5	8	11	3	002	○

CARBIDE

M14X1	P3	13	13.09	PUMR014M	5P	88	26	-	45	10.5	8	11	3	002	○
M15X1.5	P3	13.5	13.6	PUMR0150	5P	95	26	-	48	12.5	10	13	3	002	○
M15X1	P3	14	14.09	PUMR015M	5P	95	26	-	48	12.5	10	13	3	002	○

LONG

M16X1.5	P3	14.5	14.6	PUMR0160	5P	95	26	-	48	12.5	10	13	3	002	○
	P5(P3+40)	14.5	14.6	PUMT0160	5P	95	26	-	48	12.5	10	13	3	002	○
M16X1	P3	15	15.09	PUMR016M	5P	95	26	-	48	12.5	10	13	3	002	○
M18X1.5	P4	16.5	16.6	PUMS0180	5P	100	33	-	51	14	11	14	3	002	○
	P5(P4+20)	16.5	16.6	PUMT0180	5P	100	33	-	51	14	11	14	3	002	○

HAND TAPS

M20X1.5	P4	18.5	18.6	PUMS0200	5P	105	33	-	50	15	12	15	3	002	○
	P5(P4+20)	18.5	18.6	PUMT0200	5P	105	33	-	50	15	12	15	3	002	○
M22X1.5	P4	20.5	20.6	PUMS0220	5P	115	33	-	55	17	13	16	3	002	○
	P5(P4+20)	20.5	20.6	PUMT0220	5P	115	33	-	55	17	13	16	3	002	○

EG (STI)

M24X1.5	P4	22.5	22.6	PUMS0240	5P	120	39	-	55	19	15	18	3	002	○
M27X1.5	P4	25.5	25.6	PUMS0270	5P	130	39	-	60	20	15	18	4	002	○
M30X1.5	P4	28.5	28.6	PUMS0300	5P	135	46	-	62	23	17	20	4	002	○

SPECIAL THREADS, GAUGES

UNC	TCTR (tolerance)	 Hole Ø (mm)	Hole Ø (mm)	Code	THCHT (chamfer)	LF (mm)	THL (mm)	LU (mm)	LS (mm)	DCON (mm)	K (mm)	LK (mm)	NOF	Type	Stock
-----	---------------------	--	----------------	------	--------------------	------------	-------------	------------	------------	--------------	-----------	------------	-----	------	-------

THREAD MILLS

JIS															
No.2-56UNC	P1	1.8	1.83	PUMPUN2E	5P	42	8.1	12	27	3	2.5	5	2	001	○
No.4-40UNC	P2	2.3	2.33	PUMQUN4H	5P	46	9	14	26	4	3.2	6	2	001	○
No.5-40UNC	P2	2.6	2.64	PUMQUN5H	5P	52	11	16	29	5	4	7	3	001	○
No.6-32UNC	P2	2.8	2.83	PUMQUN6J	5P	52	11	16	29	5	4	7	3	001	○



DIES

No.8-32UNC	P2	3.4	3.47	PUMQUN8J	5P	60	13	21	33	5.5	4.5	7	3	001	○
No.10-24UNC	P2	3.89	3.9	PUMQUNAM	5P	60	13	22	33	5.5	4.5	7	3	001	○
1/4-20UNC	P2	5.1	5.19	PUMQU04N	5P	62	15	26	33	6	4.5	7	3	001	○

CENTER DRILLS

5/16-18UNC	P3	6.6	6.65	PUMRU050	5P	70	19	-	36	6.2	5	8	3	002	○
3/8-16UNC	P3	8	8.07	PUMRU06P	5P	75	23	-	38	7	5.5	8	3	002	○
7/16-14UNC	P3	9.4	9.45	PUMRU07Q	5P	82	26	-	42	8.5	6.5	9	3	002	○
1/2-13UNC	P3	10.9	10.91	PUMRU08R	5P	88	26	-	45	10.5	8	11	3	002	○

Technical info

UNC	TCTR (tolerance)	 Hole Ø (mm)	Hole Ø (mm)	Code	THCHT (chamfer)	LF (mm)	THL (mm)	LU (mm)	LS (mm)	DCON (mm)	K (mm)	LK (mm)	NOF	Type	Stock
JIS															
5/8-11UNC	P3	13.6	13.75	PUMRU10U	5P	95	26	-	48	12.5	10	13	3	002	○
UNF	TCTR (tolerance)	 Hole Ø (mm)	Hole Ø (mm)	Code	THCHT (chamfer)	LF (mm)	THL (mm)	LU (mm)	LS (mm)	DCON (mm)	K (mm)	LK (mm)	NOF	Type	Stock
JIS															
No.4-48UNF	P1	2.4	2.41	PUMPUN4F	5P	46	9	14	26	4	3.2	6	2	001	○
No.5-44UNF	P1	2.7	2.69	PUMPUN5G	5P	52	11	16	29	5	4	7	3	001	○
No.6-40UNF	P2	2.9	2.97	PUMQUN6H	5P	52	11	16	29	5	4	7	3	001	○
No.8-36UNF	P2	3.5	3.55	PUMQUN8I	5P	60	13	21	33	5.5	4.5	7	3	001	○
No.10-32UNF	P2	4.1	4.12	PUMQUAJ	5P	60	13	22	33	5.5	4.5	7	3	001	○
1/4-28UNF	P2	5.5	5.53	PUMQU04K	5P	62	15	26	33	6	4.5	7	3	001	○
5/16-24UNF	P2	6.9	6.97	PUMQU05M	5P	70	19	-	36	6.2	5	8	3	002	○
3/8-24UNF	P2	8.5	8.57	PUMQU06M	5P	75	23	-	38	7	5.5	8	3	002	○
7/16-20UNF	P3	9.9	9.96	PUMRU07N	5P	82	26	-	42	8.5	6.5	9	3	002	○
1/2-20UNF	P3	11.5	11.54	PUMRU08N	5P	88	26	-	45	10.5	8	11	3	002	○
9/16-18UNF	P3	12.9	13	PUMRU09O	5P	95	26	-	48	12.5	10	13	3	002	○
BSW	TCTR (tolerance)	 Hole Ø (mm)	Hole Ø (mm)	Code	THCHT (chamfer)	LF (mm)	THL (mm)	LU (mm)	LS (mm)	DCON (mm)	K (mm)	LK (mm)	NOF	Type	Stock
JIS															
3/16W24	P2	3.7	3.7	PUMQW03M	5P	60	13	21	33	5.5	4.5	7	3	001	○
1/4W20	P3	5.1	5.13	PUMRW04N	5P	62	15	26	33	6	4.5	7	3	001	○
5/16W18	P3	6.5	6.59	PUMRW05O	5P	70	19	-	36	6.2	5	8	3	002	○
3/8W16	P3	8	8.02	PUMRW06P	5P	75	23	-	38	7	5.5	8	3	002	○
7/16W14	P3	9.3	9.39	PUMRW07Q	5P	82	26	-	42	8.5	6.5	9	3	002	○
1/2W12	P3	10.6	10.7	PUMRW08S	5P	88	26	-	45	10.5	8	11	3	002	○
5/8W11	P3	13.5	13.68	PUMRW10U	5P	95	26	-	48	12.5	10	13	3	002	○
3/4W10	P4	16.5	16.63	PUMSW12V	5P	105	33	-	50	15	12	15	3	002	○
1 W8	P4	22.2	22.34	PUMSW16X	5P	125	39	-	58	19	15	18	3	002	○

Intro

SP

SL

PO

JIS

ST

ROLL

CARBIDE

LONG

HAND
TAPS

EG (STI)

SPECIAL
THREADS,
GAUGESTHREAD
MILLS

DIES

CENTER
DRILLSTechnical
info

Intro

PO

GP General Purpose Series

SP

Spiral Pointed Taps

SL



FEATURES

General purpose for through hole application.

For steel application at medium-low cutting speed, also suitable for non-ferrous materials.

PO

Recommended Tapping Speeds Depending On Materials

ANSI

ISO	Vc (m/min)	ISO	Vc (m/min)
P1	5÷10 ☆	N1	5÷10 ☆
P2	5÷10 ★	N2	5÷10 ☆
P3	5÷10 ☆	N3	5÷10 ☆
P4	5÷8 ☆	N4	5÷10 ☆

★ 1st choice ☆ suitable

ST

ROLL

CARBIDE

LONG

HAND TAPS

EG (STI)

SPECIAL THREADS, GAUGES

THREAD MILLS

DIES

CENTER DRILLS

Technical info

TYPE: US_004

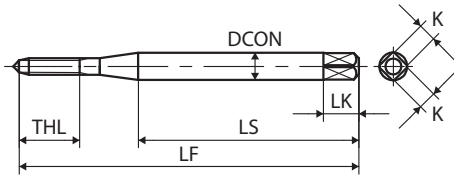

TYPE: US_005

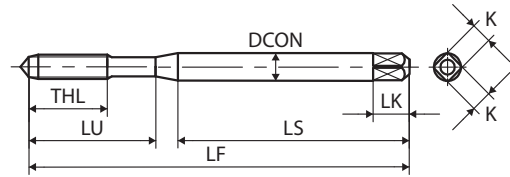

TYPE: US_006

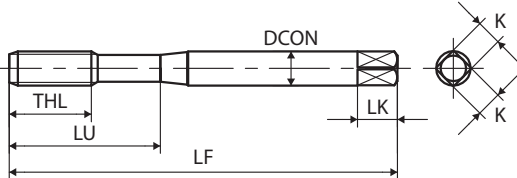

TYPE: US_007

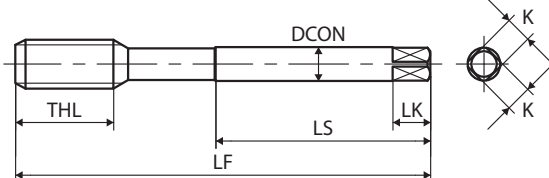

UNC	TCTR (tolerance)	∅ (mm)	Hole ∅ (mm)	Code	THCHT (chamfer)	LF (inch)	THL (inch)	LU (inch)	LS (inch)	DCON (inch)	K (inch)	LK (inch)	NOF	Type	Stock
ANSI															
No.1-64UNC	GH1	1.54	1.55	PSUN1D1NEB	5P	1.772	0.275	-	1.161	0.141	0.11	0.187	2	004	○
	GH2	1.54	1.55	PSUN1D2NEB	5P	1.772	0.275	-	1.161	0.141	0.11	0.187	2	004	○
No.2-56UNC	GH1	1.8	1.83	PSUN2E1NEB	5P	1.772	0.314	-	1.161	0.141	0.11	0.187	2	004	○
	GH2	1.8	1.83	PSUN2E2NEB	5P	1.772	0.314	-	1.161	0.141	0.11	0.187	2	004	○
No.3-48UNC	GH1	2.09	2.1	PSUN3F1NEB	5P	2.205	0.354	0.669	1.28	0.141	0.11	0.187	2	005	○
	GH2	2.09	2.1	PSUN3F2NEB	5P	2.205	0.354	0.669	1.28	0.141	0.11	0.187	2	005	○
No.4-40UNC	GH2	2.3	2.33	PSUN4H2NEB	5P	2.205	0.354	0.709	1.28	0.141	0.11	0.187	2	005	○
	GH3	2.3	2.33	PSUN4H3NEB	5P	2.205	0.354	0.709	1.28	0.141	0.11	0.187	2	005	○
No.5-40UNC	GH2	2.6	2.64	PSUN5H2NEB	5P	2.205	0.433	0.768	1.358	0.141	0.11	0.187	2	005	○
	GH3	2.6	2.64	PSUN5H3NEB	5P	2.205	0.433	0.768	1.358	0.141	0.11	0.187	2	005	○
No.6-32UNC	GH2	2.8	2.83	PSUN6J2NEB	5P	2.205	0.433	0.768	1.358	0.141	0.11	0.187	2	005	○
	GH3	2.8	2.83	PSUN6J3NEB	5P	2.205	0.433	0.768	1.358	0.141	0.11	0.187	2	005	○
No.8-32UNC	GH2	3.4	3.47	PSUN8J2NEB	5P	2.48	0.512	0.827	1.535	0.168	0.131	0.25	2	005	○
	GH3	3.4	3.47	PSUN8J3NEB	5P	2.48	0.512	0.827	1.535	0.168	0.131	0.25	2	005	○
No.10-24UNC	GH2	3.89	3.9	PSUNAM2NEB	5P	2.756	0.551	0.984	1.654	0.194	0.152	0.25	2	005	○
	GH3	3.89	3.9	PSUNAM3NEB	5P	2.756	0.551	0.984	1.654	0.194	0.152	0.25	2	005	○
No.12-24UNC	GH2	4.5	4.53	PSUNCM2NEB	5P	3.15	0.591	0.984	1.929	0.22	0.165	0.281	2	005	○
	GH3	4.5	4.53	PSUNCM3NEB	5P	3.15	0.591	0.984	1.929	0.22	0.165	0.281	2	005	○
1/4-20UNC	GH3	5.1	5.19	PSU04N3NEB	4.5P	3.15	0.591	1.181	1.713	0.255	0.191	0.312	3	005	○
	GH4	5.1	5.19	PSU04N4NEB	4.5P	3.15	0.591	1.181	1.713	0.255	0.191	0.312	3	005	○
	GH5	5.1	5.19	PSU04N5NEB	4.5P	3.15	0.591	1.181	1.713	0.255	0.191	0.312	3	005	○
5/16-18UNC	GH3	6.6	6.65	PSU0503NEB	4.5P	3.543	0.748	1.378	1.831	0.318	0.238	0.375	3	006	○
	GH4	6.6	6.65	PSU0504NEB	4.5P	3.543	0.748	1.378	1.831	0.318	0.238	0.375	3	006	○
	GH5	6.6	6.65	PSU0505NEB	4.5P	3.543	0.748	1.378	1.831	0.318	0.238	0.375	3	006	○
3/8-16UNC	GH3	8	8.07	PSU06P3NEB	4.5P	3.937	0.906	1.535	2.028	0.381	0.286	0.437	3	006	○
	GH5	8	8.07	PSU06P5NEB	4.5P	3.937	0.906	1.535	2.028	0.381	0.286	0.437	3	006	○
7/16-14UNC	GH4	9.4	9.45	PSU07Q4NEB	4.5P	3.937	0.906	-	2.008	0.323	0.242	0.406	3	007	○
	GH5	9.4	9.45	PSU07Q5NEB	4.5P	3.937	0.906	-	2.008	0.323	0.242	0.406	3	007	○
1/2-13UNC	GH3	10.9	10.91	PSU08R3NEB	4.5P	4.331	1.024	-	2.205	0.367	0.275	0.437	3	007	○
	GH4	10.9	10.91	PSU08R4NEB	4.5P	4.331	1.024	-	2.205	0.367	0.275	0.437	3	007	○
	GH5	10.9	10.91	PSU08R5NEB	4.5P	4.331	1.024	-	2.205	0.367	0.275	0.437	3	007	○
9/16-12UNC	GH3	12.2	12.33	PSU09S3NEB	4.5P	4.331	1.024	-	2.205	0.429	0.322	0.5	3	007	○
	GH4	12.2	12.33	PSU09S4NEB	4.5P	4.331	1.024	-	2.205	0.429	0.322	0.5	3	007	○
	GH5	12.2	12.33	PSU09S5NEB	4.5P	4.331	1.024	-	2.205	0.429	0.322	0.5	3	007	○
5/8-11UNC	GH3	13.6	13.75	PSU10U3NEB	4.5P	4.331	1.024	-	2.205	0.48	0.36	0.562	3	007	○
	GH4	13.6	13.75	PSU10U4NEB	4.5P	4.331	1.024	-	2.205	0.48	0.36	0.562	3	007	○
	GH5	13.6	13.75	PSU10U5NEB	4.5P	4.331	1.024	-	2.205	0.48	0.36	0.562	3	007	○
	GH6	13.6	13.75	PSU10U6NEB	4.5P	4.331	1.024	-	2.205	0.48	0.36	0.562	3	007	○
3/4-10UNC	GH5	16.6	16.7	PSU12V5NEB	4.5P	4.921	1.299	-	2.52	0.59	0.442	0.687	3	007	○
	GH6	16.6	16.7	PSU12V6NEB	4.5P	4.921	1.299	-	2.52	0.59	0.442	0.687	3	007	○
7/8-9UNC	GH4	19.6	19.61	PSU14W4NEB	4.5P	5.512	1.299	-	2.795	0.697	0.523	0.75	3	007	○
	GH5	19.6	19.61	PSU14W5NEB	4.5P	5.512	1.299	-	2.795	0.697	0.523	0.75	3	007	○
	GH6	19.6	19.61	PSU14W6NEB	4.5P	5.512	1.299	-	2.795	0.697	0.523	0.75	3	007	○
1-8UNC	GH4	22.3	22.45	PSU16X4NEB	4.5P	6.299	1.457	-	3.228	0.8	0.6	0.812	3	007	○
	GH5	22.3	22.45	PSU16X5NEB	4.5P	6.299	1.457	-	3.228	0.8	0.6	0.812	3	007	○
	GH6	22.3	22.45	PSU16X6NEB	4.5P	6.299	1.457	-	3.228	0.8	0.6	0.812	3	007	○
	GH7	22.3	22.45	PSU16X7NEB	4.5P	6.299	1.457	-	3.228	0.8	0.6	0.812	3	007	○

The most suitable GH tap class to cut accurate 2B, 3B (UNJ) and 2B oversized internal threads tolerance, depends on application conditions and work-piece materials. Yamawa GH class system offers a wide range of alternative tap classes allowing each customer to select the most suitable one according to application requirement. Check page 673 of Technical info for full details.

Spiral Pointed Taps

Intro

	UNC	TCTR (tolerance)	\varnothing (mm)	Hole \varnothing (mm)	Code	THCHT (chamfer)	LF (inch)	THL (inch)	LU (inch)	LS (inch)	DCON (inch)	K (inch)	LK (inch)	NOF	Type	Stock
ANSI																
SP	1 1/8-7UNC	GH6	25	25.17	PSU18Y6NEB	4.5P	7.087	1.732	-	3.622	0.896	0.672	0.875	4	007	○
		GH7	25	25.17	PSU18Y7NEB	4.5P	7.087	1.732	-	3.622	0.896	0.672	0.875	4	007	○
	1 1/4-7UNC	GH6	28.2	28.35	PSU20Y6NEB	4.5P	7.087	1.929	-	3.622	1.021	0.766	1	4	007	○
		GH8	28.2	28.35	PSU20Y8NEB	4.5P	7.087	1.929	-	3.622	1.021	0.766	1	4	007	○
SL	1 3/8-6UNC	GH6	30.8	30.92	PSU22Z6NEB	4.5P	7.874	2.165	-	4.016	1.108	0.831	1.062	4	007	○
		GH8	30.8	30.92	PSU22Z8NEB	4.5P	7.874	2.165	-	4.016	1.108	0.831	1.062	4	007	○
PO	1 1/2-6UNC	GH6	34	34.1	PSU24Z6NEB	4.5P	7.874	2.323	-	4.016	1.233	0.925	1.125	4	007	○
		GH8	34	34.1	PSU24Z8NEB	4.5P	7.874	2.323	-	4.016	1.233	0.925	1.125	4	007	○
ANSI	UNF	TCTR (tolerance)	\varnothing (mm)	Hole \varnothing (mm)	Code	THCHT (chamfer)	LF (inch)	THL (inch)	LU (inch)	LS (inch)	DCON (inch)	K (inch)	LK (inch)	NOF	Type	Stock
ANSI																
ST	No.0-80UNF	GH1	1.25	1.27	PSUN0B1NEB	5P	1.772	0.236	-	1.161	0.141	0.11	0.187	2	004	○
		GH2	1.25	1.27	PSUN0B2NEB	5P	1.772	0.236	-	1.161	0.141	0.11	0.187	2	004	○
	No.1-72UNF	GH1	1.55	1.58	PSUN1C1NEB	5P	1.772	0.275	-	1.161	0.141	0.11	0.187	2	004	○
		GH2	1.55	1.58	PSUN1C2NEB	5P	1.772	0.275	-	1.161	0.141	0.11	0.187	2	004	○
ROLL	No.2-64UNF	GH1	1.85	1.87	PSUN2D1NEB	5P	1.772	0.314	-	1.161	0.141	0.11	0.187	2	004	○
		GH2	1.85	1.87	PSUN2D2NEB	5P	1.772	0.314	-	1.161	0.141	0.11	0.187	2	004	○
CARBIDE	No.3-56UNF	GH1	2.1	2.15	PSUN3E1NEB	5P	2.205	0.354	0.669	1.28	0.141	0.11	0.187	2	005	○
		GH2	2.1	2.15	PSUN3E2NEB	5P	2.205	0.354	0.669	1.28	0.141	0.11	0.187	2	005	○
LONG	No.5-44UNF	GH1	2.7	2.69	PSUN5G1NEB	5P	2.205	0.433	0.768	1.358	0.141	0.11	0.187	2	005	○
		GH2	2.7	2.69	PSUN5G2NEB	5P	2.205	0.433	0.768	1.358	0.141	0.11	0.187	2	005	○
		GH3	2.7	2.69	PSUN5G3NEB	5P	2.205	0.433	0.768	1.358	0.141	0.11	0.187	2	005	○
	No.6-40UNF	GH2	2.9	2.97	PSUN6H2NEB	5P	2.205	0.433	0.768	1.358	0.141	0.11	0.187	2	005	○
		GH3	2.9	2.97	PSUN6H3NEB	5P	2.205	0.433	0.768	1.358	0.141	0.11	0.187	2	005	○
HAND TAPS	No.8-36UNF	GH2	3.5	3.55	PSUN8I2NEB	5P	2.48	0.512	0.827	1.535	0.168	0.131	0.25	2	005	○
		GH3	3.5	3.55	PSUN8I3NEB	5P	2.48	0.512	0.827	1.535	0.168	0.131	0.25	2	005	○
	No.10-32UNF	GH2	4.1	4.12	PSUNAJ2NEB	5P	2.756	0.551	0.984	1.654	0.194	0.152	0.25	2	005	○
		GH3	4.1	4.12	PSUNAJ3NEB	5P	2.756	0.551	0.984	1.654	0.194	0.152	0.25	2	005	○
EG (STI)	No.12-28UNF	GH2	4.6	4.67	PSUNCCK2NEB	5P	3.15	0.591	0.984	1.929	0.22	0.165	0.281	2	005	○
		GH3	4.6	4.67	PSUNCCK3NEB	5P	3.15	0.591	0.984	1.929	0.22	0.165	0.281	2	005	○
SPECIAL THREADS, GAUGES	1/4-28UNF	GH2	5.5	5.53	PSU04K2NEB	4.5P	3.15	0.591	1.181	1.713	0.255	0.191	0.312	3	005	○
		GH3	5.5	5.53	PSU04K3NEB	4.5P	3.15	0.591	1.181	1.713	0.255	0.191	0.312	3	005	○
		GH4	5.5	5.53	PSU04K4NEB	4.5P	3.15	0.591	1.181	1.713	0.255	0.191	0.312	3	005	○
	5/16-24UNF	GH3	6.9	6.97	PSU05M3NEB	4.5P	3.543	0.748	1.378	1.831	0.318	0.238	0.375	3	006	○
		GH4	6.9	6.97	PSU05M4NEB	4.5P	3.543	0.748	1.378	1.831	0.318	0.238	0.375	3	006	○
THREAD MILLS	3/8-24UNF	GH3	8.5	8.57	PSU06M3NEB	4.5P	3.937	0.906	1.535	2.028	0.381	0.286	0.437	3	006	○
		GH4	8.5	8.57	PSU06M4NEB	4.5P	3.937	0.906	1.535	2.028	0.381	0.286	0.437	3	006	○
DIES	7/16-20UNF	GH3	9.9	9.96	PSU07N3NEB	4.5P	3.937	0.906	-	2.008	0.323	0.242	0.406	3	007	○
		GH4	9.9	9.96	PSU07N4NEB	4.5P	3.937	0.906	-	2.008	0.323	0.242	0.406	3	007	○
		GH5	9.9	9.96	PSU07N5NEB	4.5P	3.937	0.906	-	2.008	0.323	0.242	0.406	3	007	○
CENTER DRILLS	1/2-20UNF	GH3	11.5	11.54	PSU08N3NEB	4.5P	4.331	1.024	-	2.205	0.367	0.275	0.437	3	007	○
		GH4	11.5	11.54	PSU08N4NEB	4.5P	4.331	1.024	-	2.205	0.367	0.275	0.437	3	007	○
		GH5	11.5	11.54	PSU08N5NEB	4.5P	4.331	1.024	-	2.205	0.367	0.275	0.437	3	007	○

Technical
info

UNF	TCTR (tolerance)	Hole Ø (mm)	Hole Ø (mm)	Code	THCHT (chamfer)	LF (inch)	THL (inch)	LU (inch)	LS (inch)	DCON (inch)	K (inch)	LK (inch)	NOF	Type	Stock
ANSI															
9/16-18UNF	GH3	12.9	13	PSU0903NEB	4.5P	4.331	1.024	-	2.205	0.429	0.322	0.5	3	007	○
	GH4	12.9	13	PSU0904NEB	4.5P	4.331	1.024	-	2.205	0.429	0.322	0.5	3	007	○
	GH5	12.9	13	PSU0905NEB	4.5P	4.331	1.024	-	2.205	0.429	0.322	0.5	3	007	○
5/8-18UNF	GH3	14.5	14.6	PSU1003NEB	4.5P	4.331	1.024	-	2.205	0.48	0.36	0.562	3	007	○
	GH4	14.5	14.6	PSU1004NEB	4.5P	4.331	1.024	-	2.205	0.48	0.36	0.562	3	007	○
	GH5	14.5	14.6	PSU1005NEB	4.5P	4.331	1.024	-	2.205	0.48	0.36	0.562	3	007	○
3/4-16UNF	GH3	17.5	17.59	PSU12P3NEB	4.5P	4.921	1.299	-	2.52	0.59	0.442	0.687	3	007	○
	GH4	17.5	17.59	PSU12P4NEB	4.5P	4.921	1.299	-	2.52	0.59	0.442	0.687	3	007	○
	GH5	17.5	17.59	PSU12P5NEB	4.5P	4.921	1.299	-	2.52	0.59	0.442	0.687	3	007	○
7/8-14UNF	GH4	20.5	20.57	PSU14Q4NEB	4.5P	5.512	1.299	-	2.795	0.697	0.523	0.75	3	007	○
	GH6	20.5	20.57	PSU14Q6NEB	4.5P	5.512	1.299	-	2.795	0.697	0.523	0.75	3	007	○
1 -12UNF	GH4	23.3	23.46	PSU16S4NEB	4.5P	6.299	1.457	-	3.228	0.8	0.6	0.812	3	007	○
	GH5	23.3	23.46	PSU16S5NEB	4.5P	6.299	1.457	-	3.228	0.8	0.6	0.812	3	007	○
	GH6	23.3	23.46	PSU16S6NEB	4.5P	6.299	1.457	-	3.228	0.8	0.6	0.812	3	007	○
1 1/8-12UNF	GH5	26.5	26.63	PSU18S5NEB	4.5P	7.087	1.732	-	3.622	0.896	0.672	0.875	4	007	○
	GH6	26.5	26.63	PSU18S6NEB	4.5P	7.087	1.732	-	3.622	0.896	0.672	0.875	4	007	○
1 1/4-12UNF	GH5	29.6	29.81	PSU20S5NEB	4.5P	7.087	1.929	-	3.622	1.021	0.766	1	4	007	○
	GH6	29.6	29.81	PSU20S6NEB	4.5P	7.087	1.929	-	3.622	1.021	0.766	1	4	007	○
1 3/8-12UNF	GH5	32.8	32.98	PSU22S5NEB	4.5P	7.874	2.165	-	4.016	1.108	0.831	1.062	4	007	○
	GH6	32.8	32.98	PSU22S6NEB	4.5P	7.874	2.165	-	4.016	1.108	0.831	1.062	4	007	○
1 1/2-12UNF	GH5	36	36.16	PSU24S5NEB	4.5P	7.874	2.323	-	4.016	1.233	0.925	1.125	4	007	○
	GH7	36	36.16	PSU24S7NEB	4.5P	7.874	2.323	-	4.016	1.233	0.925	1.125	4	007	○

Intro

SP

SL

PO

ANSI

ST

ROLL

CARBIDE

LONG

HAND
TAPS

EG (STI)

SPECIAL
THREADS,
GAUGESTHREAD
MILLS

DIES

CENTER
DRILLSTechnical
info

Intro

ZELX SS PO

MS Material Specific Series

Spiral Pointed Taps for Stainless Steel



SP

SL



FEATURES

Material specific for through hole application.
Most suitable for stainless steel, steel and alloy steel.
OX treatment reduces welding troubles.

PO

Recommended Tapping Speeds Depending On Materials

ANSI

ISO	Vc (m/min)	★	ISO	Vc (m/min)	★
P1	≤10	★	M1	≤10	★
P2	≤10	★	M2	≤10	★
P3	≤10	★			
P4	≤10	☆			
P7	≤10	★			

★ 1st choice ☆ suitable

ST

ROLL

CARBIDE

LONG

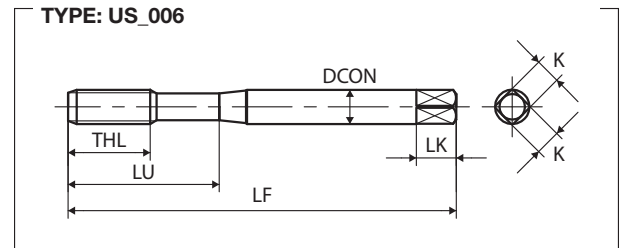
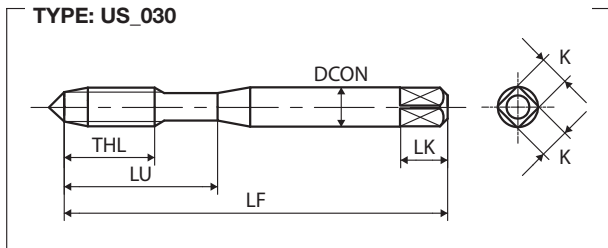

HAND TAPS

EG (STI)

SPECIAL THREADS, GAUGES

THREAD MILLS

DIES

CENTER DRILLS

Technical info

UNC	TCTR (tolerance)	\varnothing (mm)	Hole \varnothing (mm)	Code	THCHT (chamfer)	LF (inch)	THL (inch)	LU (inch)	LS (inch)	DCON (inch)	K (inch)	LK (inch)	NOF	Type	Stock
ANSI															
No.2-56UNC	GH2	1.8	1.83	Y82623	4.5P	1.75	0.256	0.437	-	0.141	0.11	0.187	2	030	○
	GH3	1.8	1.83	Y82624	4.5P	1.75	0.256	0.437	-	0.141	0.11	0.187	2	030	○
No.3-48UNC	GH2	2.09	2.1	Y82600	4.5P	1.812	0.295	0.5	-	0.141	0.11	0.187	2	030	○
No.4-40UNC	GH2	2.3	2.33	Y82601	4.5P	1.875	0.335	0.562	-	0.141	0.11	0.187	2	030	○
	GH3	2.3	2.33	Y82602	4.5P	1.875	0.335	0.562	-	0.141	0.11	0.187	2	030	○
	GH4	2.3	2.33	Y82612	4.5P	1.875	0.335	0.562	-	0.141	0.11	0.187	2	030	○
No.5-40UNC	GH2	2.3	2.33	Y82634	4.5P	1.875	0.335	0.562	-	0.141	0.11	0.187	2	030	○
	GH2	2.6	2.64	Y82603	4.5P	1.937	0.374	0.625	-	0.141	0.11	0.187	3	030	○
No.6-32UNC	GH2	2.8	2.83	Y82604	4.5P	2	0.413	0.687	-	0.141	0.11	0.187	3	030	○
	GH3	2.8	2.83	Y82605	4.5P	2	0.413	0.687	-	0.141	0.11	0.187	3	030	○
	GH4	2.8	2.83	Y82608	4.5P	2	0.413	0.687	-	0.141	0.11	0.187	3	030	○
	GH5	2.8	2.83	Y82635	4.5P	2	0.413	0.687	-	0.141	0.11	0.187	3	030	○
	GH6	2.8	2.83	Y82659	4.5P	2	0.413	0.687	-	0.141	0.11	0.187	3	030	○
	GH7	2.8	2.83	Y82665	4.5P	2	0.413	0.687	-	0.141	0.11	0.187	3	030	○
No.8-32UNC	GH2	3.4	3.47	Y82606	4.5P	2.125	0.453	0.75	-	0.168	0.131	0.25	3	030	○
	GH3	3.4	3.47	Y82607	4.5P	2.125	0.453	0.75	-	0.168	0.131	0.25	3	030	○
	GH4	3.4	3.47	Y82629	4.5P	2.125	0.453	0.75	-	0.168	0.131	0.25	3	030	○
	GH5	3.4	3.47	Y82637	4.5P	2.125	0.453	0.75	-	0.168	0.131	0.25	3	030	○
	GH6	3.4	3.47	Y82660	4.5P	2.125	0.453	0.75	-	0.168	0.131	0.25	3	030	○
No.10-24UNC	GH3	3.4	3.47	Y82667	4.5P	2.125	0.453	0.75	-	0.168	0.131	0.25	3	030	○
	GH3	3.89	3.9	Y82609	4.5P	2.375	0.531	0.875	-	0.194	0.152	0.25	3	030	○
	GH5	3.89	3.9	Y82639	4.5P	2.375	0.531	0.875	-	0.194	0.152	0.25	3	030	○
	GH6	3.89	3.9	Y82690	4.5P	2.375	0.531	0.875	-	0.194	0.152	0.25	3	030	○
	GH7	3.89	3.9	Y82669	4.5P	2.375	0.531	0.875	-	0.194	0.152	0.25	3	030	○
No.12-24UNC	GH3	4.5	4.53	Y82688	4.5P	2.375	0.571	0.937	-	0.22	0.165	0.281	3	030	○
1/4-20UNC	GH3	5.1	5.19	Y82613	4.5P	2.5	0.591	1	-	0.255	0.191	0.312	3	030	○
	GH5	5.1	5.19	Y82643	4.5P	2.5	0.591	1	-	0.255	0.191	0.312	3	030	○
	GH6	5.1	5.19	Y82590	4.5P	2.5	0.591	1	-	0.255	0.191	0.312	3	030	○
	GH7	5.1	5.19	Y82673	4.5P	2.5	0.591	1	-	0.255	0.191	0.312	3	030	○
5/16-18UNC	GH3	6.6	6.65	Y82615	4.5P	2.718	0.669	1.125	-	0.318	0.238	0.375	3	030	○
	GH5	6.6	6.65	Y82645	4.5P	2.718	0.669	1.125	-	0.318	0.238	0.375	3	030	○
	GH7	6.6	6.65	Y82675	4.5P	2.718	0.669	1.125	-	0.318	0.238	0.375	3	030	○
3/8-16UNC	GH3	8	8.07	Y82617	4.5P	2.937	0.748	1.25	-	0.381	0.286	0.437	3	030	○
	GH5	8	8.07	Y82647	4.5P	2.937	0.748	1.25	-	0.381	0.286	0.437	3	030	○
	GH7	8	8.07	Y82668	4.5P	2.937	0.748	1.25	-	0.381	0.286	0.437	3	030	○
7/16-14UNC	GH3	9.4	9.45	Y82619	4.5P	3.156	0.866	-	-	0.323	0.242	0.406	3	006	○
	GH5	9.4	9.45	Y82649	4.5P	3.156	0.866	-	-	0.323	0.242	0.406	3	006	○
1/2-13UNC	GH3	10.9	10.91	Y82621	4.5P	3.375	0.984	-	-	0.367	0.275	0.437	3	006	○
	GH5	10.9	10.91	Y82651	4.5P	3.375	0.984	-	-	0.367	0.275	0.437	3	006	○
	GH7	10.9	10.91	Y82681	4.5P	3.375	0.984	-	-	0.367	0.275	0.437	3	006	○
9/16-12UNC	GH3	12.2	12.33	Y82653	4.5P	3.593	0.984	-	-	0.429	0.322	0.5	3	006	○
5/8-11UNC	GH3	13.6	13.75	Y82625	4.5P	3.812	1.083	-	-	0.48	0.36	0.562	3	006	○
	GH5	13.6	13.75	Y82655	4.5P	3.812	1.083	-	-	0.48	0.36	0.562	3	006	○
3/4-10UNC	GH3	16.6	16.7	Y82627	4.5P	4.25	1.201	-	-	0.59	0.422	0.687	3	006	○
	GH5	16.6	16.7	Y82657	4.5P	4.25	1.201	-	-	0.59	0.422	0.687	3	006	○
7/8-9UNC	GH4	19.6	19.61	Y82695	4.5P	4.687	1.339	-	-	0.697	0.523	0.75	3	006	○
1 -8UNC	GH4	22.3	22.45	Y82697	4.5P	5.125	1.496	-	-	0.8	0.6	0.812	3	006	○

Intro

SP

SL

PO

ANSI

ST

ROLL

CARBIDE

LONG

HAND
TAPS

EG (STI)

SPECIAL
THREADS,
GAUGESTHREAD
MILLS

DIES

CENTER
DRILLSTechnical
info

The most suitable GH tap class to cut accurate 2B, 3B (UNJ) and 2B oversized internal threads tolerance, depends on application conditions and work-piece materials. Yamawa GH class system offers a wide range of alternative tap classes allowing each customer to select the most suitable one according to application requirement. Check page 673 of Technical info for full details.

Spiral Pointed Taps

Intro

UNC		TCTR (tolerance)	\varnothing (mm)	Hole \varnothing (mm)	Code	THCHT (chamfer)	LF (inch)	THL (inch)	LU (inch)	LS (inch)	DCON (inch)	K (inch)	LK (inch)	NOF	Type	Stock
ANSI																
SP	1 1/8-7UNC	GH6	25	25.17	Y82700	4.5P	5.437	1.535	-	-	0.896	0.672	0.875	4	006	○
	1 1/4-7UNC	GH6	28.2	28.35	Y82702	4.5P	5.75	1.535	-	-	1.021	0.766	1	4	006	○
	1 3/8-6UNC	GH6	30.8	30.92	Y82705	4.5P	6.062	1.811	-	-	1.108	0.831	1.062	4	006	○
SL	1 1/2-6UNC	GH6	34	34.1	Y82707	4.5P	6.375	1.811	-	-	1.233	0.925	1.125	4	006	○
	1 3/4-5UNC	GH7	39.5	39.61	Y82709	4.5P	7	1.929	-	-	1.43	1.072	1.25	4	006	○
	2-4.5UNC	GH7	45.2	45.37	Y82710	4.5P	7.625	1.929	-	-	1.644	1.233	1.375	4	006	○

PO

ANSI

ST

ROLL

CARBIDE

LONG

HAND
TAPS

EG (STI)

SPECIAL
THREADS,
GAUGES

THREAD
MILLS

DIES

CENTER
DRILLS

UNF		TCTR (tolerance)	\varnothing (mm)	Hole \varnothing (mm)	Code	THCHT (chamfer)	LF (inch)	THL (inch)	LU (inch)	LS (inch)	DCON (inch)	K (inch)	LK (inch)	NOF	Type	Stock
ANSI																
ANSI	No.4-48UNF	GH2	2.4	2.41	Y82683	4.5P	1.875	0.335	0.562	-	0.141	0.11	0.187	2	030	○
	ANSI	No.6-40UNF	GH2	2.9	2.97	Y82684	4.5P	2	0.413	0.687	-	0.141	0.11	0.187	3	030
GH3			2.9	2.97	Y82642	4.5P	2	0.413	0.687	-	0.141	0.11	0.187	3	030	○
ST	No.8-36UNF	GH2	3.5	3.55	Y82686	4.5P	2.125	0.453	0.75	-	0.168	0.131	0.25	3	030	○
		GH2	4.1	4.12	Y82611	4.5P	2.375	0.531	0.875	-	0.194	0.152	0.25	3	030	○
ROLL	No.10-32UNF	GH3	4.1	4.12	Y82610	4.5P	2.375	0.531	0.875	-	0.194	0.152	0.25	3	030	○
		GH4	4.1	4.12	Y82630	4.5P	2.375	0.531	0.875	-	0.194	0.152	0.25	3	030	○
		GH5	4.1	4.12	Y82640	4.5P	2.375	0.531	0.875	-	0.194	0.152	0.25	3	030	○
		GH6	4.1	4.12	Y82661	4.5P	2.375	0.531	0.875	-	0.194	0.152	0.25	3	030	○
		GH7	4.1	4.12	Y82670	4.5P	2.375	0.531	0.875	-	0.194	0.152	0.25	3	030	○
CARBIDE	No.12-28UNF	GH3	4.6	4.67	Y82689	4.5P	2.375	0.571	0.937	-	0.22	0.165	0.281	3	030	○
		GH3	5.5	5.53	Y82614	4.5P	2.5	0.591	1	-	0.255	0.191	0.312	3	030	○
LONG	1/4-28UNF	GH4	5.5	5.53	Y82631	4.5P	2.5	0.591	1	-	0.255	0.191	0.312	3	030	○
		GH5	5.5	5.53	Y82644	4.5P	2.5	0.591	1	-	0.255	0.191	0.312	3	030	○
		GH6	5.5	5.53	Y82662	4.5P	2.5	0.591	1	-	0.255	0.191	0.312	3	030	○
		GH7	5.5	5.53	Y82674	4.5P	2.5	0.591	1	-	0.255	0.191	0.312	3	030	○
		GH3	6.9	6.97	Y82616	4.5P	2.718	0.669	1.125	-	0.318	0.238	0.375	3	030	○
HAND TAPS	5/16-24UNF	GH4	6.9	6.97	Y82632	4.5P	2.718	0.669	1.125	-	0.318	0.238	0.375	3	030	○
		GH5	6.9	6.97	Y82646	4.5P	2.718	0.669	1.125	-	0.318	0.238	0.375	3	030	○
		GH6	6.9	6.97	Y82663	4.5P	2.718	0.669	1.125	-	0.318	0.238	0.375	3	030	○
		GH7	6.9	6.97	Y82676	4.5P	2.718	0.669	1.125	-	0.318	0.238	0.375	3	030	○
		GH3	8.5	8.57	Y82618	4.5P	2.937	0.748	1.25	-	0.381	0.286	0.437	3	030	○
EG (STI)	3/8-24UNF	GH4	8.5	8.57	Y82633	4.5P	2.937	0.748	1.25	-	0.381	0.286	0.437	3	030	○
		GH5	8.5	8.57	Y82648	4.5P	2.937	0.748	1.25	-	0.381	0.286	0.437	3	030	○
		GH6	8.5	8.57	Y82664	4.5P	2.937	0.748	1.25	-	0.381	0.286	0.437	3	030	○
		GH7	8.5	8.57	Y82678	4.5P	2.937	0.748	1.25	-	0.381	0.286	0.437	3	030	○
		GH3	9.9	9.96	Y82620	4.5P	3.156	0.866	-	-	0.323	0.242	0.406	3	006	○
THREAD MILLS	7/16-20UNF	GH5	9.9	9.96	Y82650	4.5P	3.156	0.866	-	-	0.323	0.242	0.406	3	006	○
		GH6	9.9	9.96	Y82691	4.5P	3.156	0.866	-	-	0.323	0.242	0.406	3	006	○
		GH7	9.9	9.96	Y82680	4.5P	3.156	0.866	-	-	0.323	0.242	0.406	3	006	○
		GH3	11.5	11.54	Y82622	4.5P	3.375	0.984	-	-	0.367	0.275	0.437	3	006	○
DIES	1/2-20UNF	GH5	11.5	11.54	Y82652	4.5P	3.375	0.984	-	-	0.367	0.275	0.437	3	006	○
		GH6	11.5	11.54	Y82692	4.5P	3.375	0.984	-	-	0.367	0.275	0.437	3	006	○
		GH7	11.5	11.54	Y82682	4.5P	3.375	0.984	-	-	0.367	0.275	0.437	3	006	○
		GH9	11.5	11.54	Y82685	4.5P	3.375	0.984	-	-	0.367	0.275	0.437	3	006	○
		GH3	12.9	13	Y82654	4.5P	3.593	0.984	-	-	0.429	0.322	0.5	3	006	○
CENTER DRILLS	9/16-18UNF	GH5	12.9	13	Y82666	4.5P	3.593	0.984	-	-	0.429	0.322	0.5	3	006	○

Technical
info

UNF	TCTR (tolerance)	Ø (mm)	Hole Ø (mm)	Code	THCHT (chamfer)	LF (inch)	THL (inch)	LU (inch)	LS (inch)	DCON (inch)	K (inch)	LK (inch)	NOF	Type	Stock
ANSI															
5/8-18UNF	GH3	14.5	14.6	Y82626	4.5P	3.812	1.083	-	-	0.48	0.36	0.562	3	006	○
	GH4	14.5	14.6	Y82636	4.5P	3.812	1.083	-	-	0.48	0.36	0.562	3	006	○
	GH5	14.5	14.6	Y82656	4.5P	3.812	1.083	-	-	0.48	0.36	0.562	3	006	○
	GH6	14.5	14.6	Y82694	4.5P	3.812	1.083	-	-	0.48	0.36	0.562	3	006	○
	GH7	14.5	14.6	Y82591	4.5P	3.812	1.083	-	-	0.48	0.36	0.562	3	006	○
3/4-16UNF	GH3	17.5	17.59	Y82628	4.5P	4.25	1.201	-	-	0.59	0.422	0.687	3	006	○
	GH5	17.5	17.59	Y82658	4.5P	4.25	1.201	-	-	0.59	0.422	0.687	3	006	○
	GH7	17.5	17.59	Y82592	4.5P	4.25	1.201	-	-	0.59	0.422	0.687	3	006	○
7/8-14UNF	GH4	20.5	20.57	Y82696	4.5P	4.687	1.339	-	-	0.697	0.523	0.75	3	006	○
	GH6	20.5	20.57	Y82699	4.5P	4.687	1.339	-	-	0.697	0.523	0.75	3	006	○
1 -12UNF	GH4	23.3	23.46	Y82679	4.5P	5.125	1.496	-	-	0.8	0.6	0.812	3	006	○
1 1/8-12UNF	GH5	26.5	26.63	Y82701	4.5P	5.437	1.535	-	-	0.896	0.672	0.875	4	006	○
1 1/4-12UNF	GH5	29.6	29.81	Y82703	4.5P	5.75	1.535	-	-	1.021	0.766	1	4	006	○
1 3/8-12UNF	GH5	32.8	32.98	Y82706	4.5P	6.062	1.811	-	-	1.108	0.831	1.062	4	006	○
1 1/2-12UNF	GH5	36	36.16	Y82708	4.5P	6.375	1.811	-	-	1.233	0.925	1.125	4	006	○

Intro

SP

SL

PO

ANSI

ST

ROLL

CARBIDE

LONG

HAND
TAPS

EG (STI)

SPECIAL
THREADS,
GAUGESTHREAD
MILLS

DIES

CENTER
DRILLSTechnical
info

The most suitable GH tap class to cut accurate 2B, 3B (UNJ) and 2B oversized internal threads tolerance, depends on application conditions and work-piece materials. Yamawa GH class system offers a wide range of alternative tap classes allowing each customer to select the most suitable one according to application requirement. Check page 673 of Technical info for full details.

Intro

ZELX AL PO

MS Material Specific Series

Spiral Pointed Taps for Aluminium



SP

SL



FEATURES

Material specific for through hole application.
Specific design and NI treatment allow stable and long life on Aluminium, Aluminium casting and die-casting.

PO

Recommended Tapping Speeds Depending On Materials

ANSI

ISO	Vc (m/min)
N1	5÷15 ★
N2	5÷15 ★
N3	5÷15 ★

★ 1st choice ☆ suitable

ST

ROLL

CARBIDE

LONG

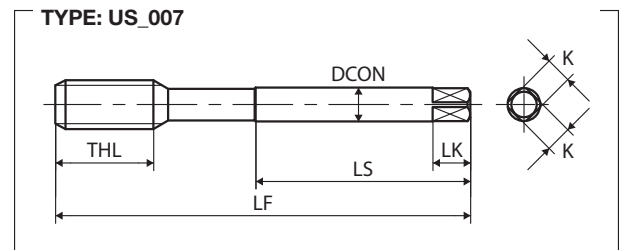
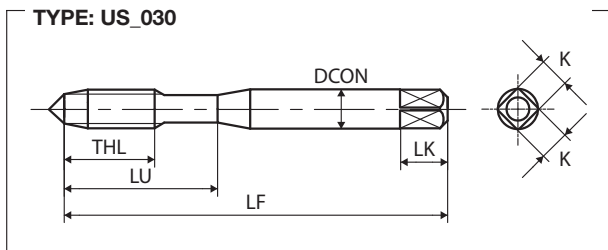

HAND TAPS

EG (STI)



SPECIAL THREADS, GAUGES

THREAD MILLS

DIES

CENTER DRILLS

Technical info

UNC	TCTR (tolerance)	 Hole Ø (mm)	Hole Ø (mm)	Code	THCHT (chamfer)	LF (inch)	THL (inch)	LU (inch)	LS (inch)	DCON (inch)	K (inch)	LK (inch)	NOF	Type	Stock
ANSI															
No.2-56UNC	GH2	1.8	1.83	Y86200	5P	1.772	0.276	0.472	-	0.141	0.11	0.187	2	030	○
No.4-40UNC	GH2	2.3	2.33	Y86201	5P	2.205	0.433	0.709	-	0.141	0.11	0.187	2	030	○
No.5-40UNC	GH2	2.6	2.64	Y86202	5P	2.205	0.433	0.709	-	0.141	0.11	0.187	3	030	○
No.6-32UNC	GH3	2.8	2.83	Y86203	5P	2.205	0.512	0.787	-	0.141	0.11	0.187	3	030	○
No.8-32UNC	GH3	3.4	3.47	Y86204	5P	2.48	0.512	0.827	-	0.168	0.131	0.25	3	030	○
No.10-24UNC	GH3	3.89	3.9	Y86205	5P	2.756	0.63	0.984	-	0.194	0.152	0.25	3	030	○
1/4-20UNC	GH3	5.1	5.19	Y86207	5P	3.15	0.748	1.181	-	0.255	0.191	0.312	3	030	○
	GH5	5.1	5.19	Y86208	5P	3.15	0.748	1.181	-	0.255	0.191	0.312	3	030	○
5/16-18UNC	GH3	6.6	6.65	Y86212	5P	3.543	0.866	1.378	-	0.318	0.238	0.375	3	030	○
	GH5	6.6	6.65	Y86213	5P	3.543	0.866	1.378	-	0.318	0.238	0.375	3	030	○
3/8-16UNC	GH3	8	8.07	Y86216	5P	3.937	0.945	1.535	-	0.381	0.286	0.437	3	030	○
	GH5	8	8.07	Y86217	5P	3.937	0.945	1.535	-	0.381	0.286	0.437	3	030	○
7/16-14UNC	GH3	9.4	9.45	Y86220	5P	3.937	0.945	-	-	0.323	0.242	0.406	3	007	○
	GH5	9.4	9.45	Y86221	5P	3.937	0.945	-	-	0.323	0.242	0.406	3	007	○
1/2-13UNC	GH3	10.9	10.91	Y86224	5P	4.331	1.142	-	-	0.367	0.275	0.437	3	007	○
	GH5	10.9	10.91	Y86225	5P	4.331	1.142	-	-	0.367	0.275	0.437	3	007	○
ANSI															
UNF	TCTR (tolerance)	 Hole Ø (mm)	Hole Ø (mm)	Code	THCHT (chamfer)	LF (inch)	THL (inch)	LU (inch)	LS (inch)	DCON (inch)	K (inch)	LK (inch)	NOF	Type	Stock
ANSI															
No.10-32UNF	GH3	4.1	4.12	Y86206	5P	2.756	0.63	0.984	-	0.194	0.152	0.25	3	030	○
1/4-28UNF	GH3	5.5	5.53	Y86209	5P	3.15	0.748	1.181	-	0.255	0.191	0.312	3	030	○
	GH4	5.5	5.53	Y86211	5P	3.15	0.748	1.181	-	0.255	0.191	0.312	3	030	○
5/16-24UNF	GH3	6.9	6.97	Y86214	5P	3.543	0.866	1.378	-	0.318	0.238	0.375	3	030	○
	GH4	6.9	6.97	Y86215	5P	3.543	0.866	1.378	-	0.318	0.238	0.375	3	030	○
3/8-24UNF	GH3	8.5	8.57	Y86218	5P	3.543	0.787	1.535	-	0.381	0.286	0.437	3	030	○
	GH4	8.5	8.57	Y86219	5P	3.543	0.787	1.535	-	0.381	0.286	0.437	3	030	○
7/16-20UNF	GH3	9.9	9.96	Y86222	5P	3.937	0.945	-	-	0.323	0.242	0.406	3	007	○
	GH5	9.9	9.96	Y86223	5P	3.937	0.945	-	-	0.323	0.242	0.406	3	007	○
1/2-20UNF	GH3	11.5	11.54	Y86226	5P	3.937	0.866	-	-	0.367	0.275	0.437	3	007	○
	GH5	11.5	11.54	Y86227	5P	3.937	0.866	-	-	0.367	0.275	0.437	3	007	○

Intro

SP

SL

PO

ANSI

ST

ROLL

CARBIDE

LONG

HAND TAPS

EG (STI)

SPECIAL THREADS, GAUGES

THREAD MILLS

DIES

CENTER DRILLS

Technical info

The most suitable GH tap class to cut accurate 2B, 3B (UNJ) and 2B oversized internal threads tolerance, depends on application conditions and work-piece materials. Yamawa GH class system offers a wide range of alternative tap classes allowing each customer to select the most suitable one according to application requirement. Check page 673 of Technical info for full details.

Intro

ZELX NI PO

MS Material Specific Series

SP Spiral Pointed Taps for Nickel Base Alloys

SL



PO Recommended Tapping Speeds Depending On Materials

ANSI

ISO	Vc (m/min)	★	ISO	Vc (m/min)	★	ISO	Vc (m/min)	★
P3	5÷15	★	M1	5÷15	★	S1	5÷10	★
P4	5÷15	★	M2	5÷15	★	S2	5÷10	★
P5	5÷10	☆	M3	4÷8	★	S3	3÷6	☆
P7	5÷15	★						
P8	4÷8	★						

★ 1st choice ☆ suitable

ST

ROLL

CARBIDE

LONG

HAND TAPS

EG (STI)

SPECIAL THREADS, GAUGES

THREAD MILLS

DIES

CENTER DRILLS

Technical info



FEATURES

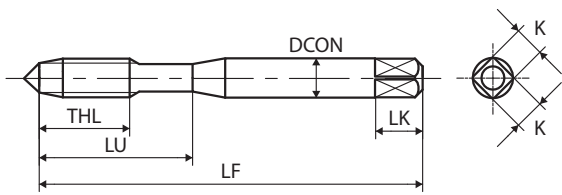

Material specific for through hole application. Specific design and NI+OX treatment allow high performance on Nickel base alloys. Also suitable for stainless steel and high alloy steel.

TYPE: US_030

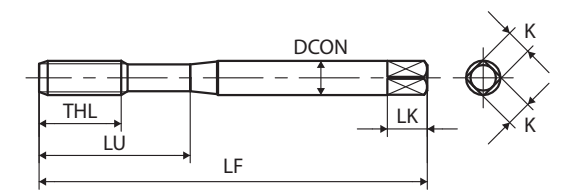

TYPE: US_006



UNC	TCTR (tolerance)	 Hole Ø (mm)	Hole Ø (mm)	Code	THCHT (chamfer)	LF (inch)	THL (inch)	LU (inch)	LS (inch)	DCON (inch)	K (inch)	LK (inch)	NOF	Type	Stock
ANSI															
No.2-56UNC	GH2	1.8	1.83	Y85523	4.5P	1.75	0.256	0.437	-	0.141	0.11	0.187	2	030	○
No.4-40UNC	GH2	2.3	2.33	Y85501	4.5P	1.875	0.335	0.562	-	0.141	0.11	0.187	2	030	○
	GH3	2.3	2.33	Y85502	4.5P	1.875	0.335	0.562	-	0.141	0.11	0.187	2	030	○
	GH4	2.3	2.33	Y85504	4.5P	1.875	0.335	0.562	-	0.141	0.11	0.187	2	030	○
No.5-40UNC	GH2	2.6	2.64	Y85503	4.5P	1.937	0.374	0.625	-	0.141	0.11	0.187	3	030	○
No.6-32UNC	GH3	2.8	2.83	Y85505	4.5P	2	0.413	0.687	-	0.141	0.11	0.187	3	030	○
	GH4	2.8	2.83	Y85524	4.5P	2	0.413	0.687	-	0.141	0.11	0.187	3	030	○
	GH5	2.8	2.83	Y85535	4.5P	2	0.413	0.687	-	0.141	0.11	0.187	3	030	○
	GH7	2.8	2.83	Y85511	4.5P	2	0.413	0.687	-	0.141	0.11	0.187	3	030	○
No.8-32UNC	GH3	3.4	3.47	Y85507	4.5P	2.125	0.453	0.75	-	0.168	0.131	0.25	3	030	○
	GH3	3.4	3.47	Y85507NI	4.5P	2.125	0.453	0.75	-	0.168	0.131	0.25	3	030	○
	GH4	3.4	3.47	Y85529	4.5P	2.125	0.453	0.75	-	0.168	0.131	0.25	3	030	○
	GH5	3.4	3.47	Y85537	4.5P	2.125	0.453	0.75	-	0.168	0.131	0.25	3	030	○
	GH5	3.4	3.47	Y85537NI	4.5P	2.125	0.453	0.75	-	0.168	0.131	0.25	3	030	○
	GH6	3.4	3.47	Y85560	4.5P	2.125	0.453	0.75	-	0.168	0.131	0.25	3	030	○
	GH6	3.4	3.47	Y85560NI	4.5P	2.125	0.453	0.75	-	0.168	0.131	0.25	3	030	○
	GH7	3.4	3.47	Y85567	4.5P	2.125	0.453	0.75	-	0.168	0.131	0.25	3	030	○
GH7	3.4	3.47	Y85567NI	4.5P	2.125	0.453	0.75	-	0.168	0.131	0.25	3	030	○	
No.10-24UNC	GH3	3.89	3.9	Y85509	4.5P	2.375	0.531	0.875	-	0.194	0.152	0.25	3	030	○
	GH5	3.89	3.9	Y85539	4.5P	2.375	0.531	0.875	-	0.194	0.152	0.25	3	030	○
1/4-20UNC	GH3	5.1	5.19	Y85513	4.5P	2.5	0.591	1	-	0.255	0.191	0.312	3	030	○
	GH3	5.1	5.19	Y85513NI	4.5P	2.5	0.591	1	-	0.255	0.191	0.312	3	030	○
	GH5	5.1	5.19	Y85543	4.5P	2.5	0.591	1	-	0.255	0.191	0.312	3	030	○
	GH5	5.1	5.19	Y85543NI	4.5P	2.5	0.591	1	-	0.255	0.191	0.312	3	030	○
5/16-18UNC	GH3	6.6	6.65	Y85515	4.5P	2.718	0.669	1.125	-	0.318	0.238	0.375	3	030	○
	GH5	6.6	6.65	Y85545	4.5P	2.718	0.669	1.125	-	0.318	0.238	0.375	3	030	○
	GH7	6.6	6.65	Y85553	4.5P	2.718	0.669	1.125	-	0.318	0.238	0.375	3	030	○
3/8-16UNC	GH3	8	8.07	Y85517	4.5P	2.937	0.748	1.25	-	0.381	0.286	0.437	3	030	○
	GH5	8	8.07	Y85547	4.5P	2.937	0.748	1.25	-	0.381	0.286	0.437	3	030	○
7/16-14UNC	GH3	9.4	9.45	Y85519	4.5P	3.156	0.866	-	-	0.323	0.242	0.406	3	006	○
	GH5	9.4	9.45	Y85549	4.5P	3.156	0.866	-	-	0.323	0.242	0.406	3	006	○
1/2-13UNC	GH3	10.9	10.91	Y85521	4.5P	3.375	0.984	-	-	0.367	0.275	0.437	3	006	○
	GH5	10.9	10.91	Y85551	4.5P	3.375	0.984	-	-	0.367	0.275	0.437	3	006	○
	GH7	10.9	10.91	Y85581	4.5P	3.375	0.984	-	-	0.367	0.275	0.437	3	006	○
5/8-11UNC	GH3	13.6	13.75	Y85525	4.5P	3.812	1.083	-	-	0.48	0.36	0.562	3	006	○
	GH5	13.6	13.75	Y85555	4.5P	3.812	1.083	-	-	0.48	0.36	0.562	3	006	○
	GH7	13.6	13.75	Y85585	4.5P	3.812	1.083	-	-	0.48	0.36	0.562	3	006	○
3/4-10UNC	GH3	16.6	16.7	Y85527	4.5P	4.25	1.201	-	-	0.59	0.442	0.687	3	006	○
	GH5	16.6	16.7	Y85557	4.5P	4.25	1.201	-	-	0.59	0.442	0.687	3	006	○
UNF	TCTR (tolerance)	 Hole Ø (mm)	Hole Ø (mm)	Code	THCHT (chamfer)	LF (inch)	THL (inch)	LU (inch)	LS (inch)	DCON (inch)	K (inch)	LK (inch)	NOF	Type	Stock
ANSI															
No.6-40UNF	GH2	2.9	2.97	Y85512	4.5P	2	0.413	0.687	-	0.141	0.11	0.187	3	030	○

The most suitable GH tap class to cut accurate 2B, 3B (UNJ) and 2B oversized internal threads tolerance, depends on application conditions and work-piece materials. Yamawa GH class system offers a wide range of alternative tap classes allowing each customer to select the most suitable one according to application requirement. Check page 673 of Technical info for full details.

Spiral Pointed Taps

Intro

UNF

TCTR
(tolerance)

\varnothing
(mm)

Hole \varnothing
(mm)

Code

THCHT
(chamfer)

LF
(inch)

THL
(inch)

LU
(inch)

LS
(inch)

DCON
(inch)

K
(inch)

LK
(inch)

NOF

Type

Stock

ANSI

SP

SL

PO

ANSI

ST

ROLL

CARBIDE

LONG

HAND
TAPS

EG (STI)

SPECIAL
THREADS,
GAUGES

THREAD
MILLS

DIES

CENTER
DRILLS

Technical
info

	UNF	TCTR (tolerance)	\varnothing (mm)	Hole \varnothing (mm)	Code	THCHT (chamfer)	LF (inch)	THL (inch)	LU (inch)	LS (inch)	DCON (inch)	K (inch)	LK (inch)	NOF	Type	Stock
	ANSI															
	No.10-32UNF	GH3	4.1	4.12	Y85510	4.5P	2.375	0.531	0.875	-	0.194	0.152	0.25	3	030	●
SP		GH3	4.1	4.12	Y85510NI	4.5P	2.375	0.531	0.875	-	0.194	0.152	0.25	3	030	○
		GH4	4.1	4.12	Y85530	4.5P	2.375	0.531	0.875	-	0.194	0.152	0.25	3	030	○
		GH4	4.1	4.12	Y85530NI	4.5P	2.375	0.531	0.875	-	0.194	0.152	0.25	3	030	○
		GH5	4.1	4.12	Y85540	4.5P	2.375	0.531	0.875	-	0.194	0.152	0.25	3	030	○
		GH5	4.1	4.12	Y85540NI	4.5P	2.375	0.531	0.875	-	0.194	0.152	0.25	3	030	○
		GH6	4.1	4.12	Y85561	4.5P	2.375	0.531	0.875	-	0.194	0.152	0.25	3	030	○
		GH6	4.1	4.12	Y85561NI	4.5P	2.375	0.531	0.875	-	0.194	0.152	0.25	3	030	○
		GH7	4.1	4.12	Y85570	4.5P	2.375	0.531	0.875	-	0.194	0.152	0.25	3	030	○
		GH7	4.1	4.12	Y85570NI	4.5P	2.375	0.531	0.875	-	0.194	0.152	0.25	3	030	○
	GH2	4.1	4.12	Y85541	4.5P	2.375	0.531	0.875	-	0.194	0.152	0.25	3	030	○	
	1/4-28UNF	GH3	5.5	5.53	Y85514	4.5P	2.5	0.591	1	-	0.255	0.191	0.312	3	030	●
		GH4	5.5	5.53	Y85531	4.5P	2.5	0.591	1	-	0.255	0.191	0.312	3	030	○
		GH4	5.5	5.53	Y85531NI	4.5P	2.5	0.591	1	-	0.255	0.191	0.312	3	030	○
		GH5	5.5	5.53	Y85544	4.5P	2.5	0.591	1	-	0.255	0.191	0.312	3	030	○
		GH5	5.5	5.53	Y85544NI	4.5P	2.5	0.591	1	-	0.255	0.191	0.312	3	030	○
		GH6	5.5	5.53	Y85562	4.5P	2.5	0.591	1	-	0.255	0.191	0.312	3	030	○
		GH6	5.5	5.53	Y85562NI	4.5P	2.5	0.591	1	-	0.255	0.191	0.312	3	030	○
		GH7	5.5	5.53	Y85574	4.5P	2.5	0.591	1	-	0.255	0.191	0.312	3	030	○
	GH7	5.5	5.53	Y85574NI	4.5P	2.5	0.591	1	-	0.255	0.191	0.312	3	030	○	
	5/16-24UNF	GH3	6.9	6.97	Y85516	4.5P	2.718	0.669	1.125	-	0.318	0.238	0.375	3	030	●
		GH4	6.9	6.97	Y85532	4.5P	2.718	0.669	1.125	-	0.318	0.238	0.375	3	030	○
		GH5	6.9	6.97	Y85546	4.5P	2.718	0.669	1.125	-	0.318	0.238	0.375	3	030	○
		GH6	6.9	6.97	Y85563	4.5P	2.718	0.669	1.125	-	0.318	0.238	0.375	3	030	○
		GH7	6.9	6.97	Y85576	4.5P	2.718	0.669	1.125	-	0.318	0.238	0.375	3	030	○
	3/8-24UNF	GH3	8.5	8.57	Y85518	4.5P	2.937	0.748	1.25	-	0.381	0.286	0.437	3	030	●
		GH4	8.5	8.57	Y85533	4.5P	2.937	0.748	1.25	-	0.381	0.286	0.437	3	030	○
		GH5	8.5	8.57	Y85548	4.5P	2.937	0.748	1.25	-	0.381	0.286	0.437	3	030	○
		GH6	8.5	8.57	Y85564	4.5P	2.937	0.748	1.25	-	0.381	0.286	0.437	3	030	○
		GH7	8.5	8.57	Y85578	4.5P	2.937	0.748	1.25	-	0.381	0.286	0.437	3	030	○
	7/16-20UNF	GH3	9.9	9.96	Y85520	4.5P	3.156	0.866	-	-	0.323	0.242	0.406	3	006	○
		GH5	9.9	9.96	Y85550	4.5P	3.156	0.866	-	-	0.323	0.242	0.406	3	006	○
	1/2-20UNF	GH3	11.5	11.54	Y85522	4.5P	3.375	0.984	-	-	0.367	0.275	0.437	3	006	○
		GH5	11.5	11.54	Y85552	4.5P	3.375	0.984	-	-	0.367	0.275	0.437	3	006	○
		GH7	11.5	11.54	Y85582	4.5P	3.375	0.984	-	-	0.367	0.275	0.437	3	006	○
		GH7	11.5	11.54	Y85582NI	4.5P	3.375	0.984	-	-	0.367	0.275	0.437	3	006	○
	5/8-18UNF	GH3	14.5	14.6	Y85526	4.5P	3.812	1.083	-	-	0.48	0.36	0.562	3	006	○
		GH5	14.5	14.6	Y85556	4.5P	3.812	1.083	-	-	0.48	0.36	0.562	3	006	○
		GH7	14.5	14.6	Y85586	4.5P	3.812	1.083	-	-	0.48	0.36	0.562	3	006	○
	3/4-16UNF	GH3	17.5	17.59	Y85528	4.5P	4.25	1.201	-	-	0.59	0.442	0.687	3	006	○
		GH5	17.5	17.59	Y85558	4.5P	4.25	1.201	-	-	0.59	0.442	0.687	3	006	○

STRAIGHT FLUTED TAPS



ST - DIN **264**
ST - JIS **288**
ST - ANSI **334**

Selection Chart

Intro

SP

SL

PO

ST

ROLL

CARBIDE

LONG

HAND TAPS

EG (STI)

SPECIAL THREADS, GAUGES

THREAD MILLS

DIES

CENTER DRILLS

Technical info

		Z-PRO						GP General Purpose									
		GGST		GGST CH		GGST CH E(1.5P)		HT		HT LH		PF LH		NPT		NPTF	
		HSS-E	COATING	HSS-E	COATING	HSS-E	COATING	HSS-E	HSS-E	HSS-E	HSS-E	HSS-E	HSS-E	HSS-E	OX		
		DIN	DIN	DIN	DIN	JIS	ANSI	JIS	JIS	ANSI	ANSI						
M		265	267	269	271	289		315									
MF		265	267	269	271	293		316									
UNC/UNF					271	306	335	321									
UNS, 8, 12, 20, 32UN						310											
UNEF						311											
G (BSP)		265			272				323								
Rp (BSPP)																	
Rc (BSPT)																	
NPT										340							
NPTF												341					
NPSC, NPSM, NPSF																	
BSW						312		322									
EG(STI), M, MF, UNC/UNF																	
Pg																	
Tr																	
S miniature																	
Special threads																	
		Vc (m/min)															
P1						☆	5÷10	☆	5÷10	☆	5÷10	★	≤5	★	≤5		
P2						★	5÷10	★	5÷10	★	5÷10	★	≤5	★	≤5		
P3						☆	5÷10	☆	5÷10	☆	5÷10	☆	≤5	☆	≤5		
P4						☆	5÷10	☆	5÷10	☆	5÷10	☆	≤5	☆	≤5		
P5																	
P6																	
P7																	
P8																	
M1																	
M2																	
M3																	
K1		★	5÷20	★	10÷30	★	10÷30	☆	5÷10	☆	5÷10	☆	5÷10	☆	≤5		
K2		★	5÷20	★	10÷30	★	10÷30	☆	5÷10	☆	5÷10	☆	5÷10	☆	≤5		
K3		★	≤10	★	≤15	★	≤15	☆	5÷10	☆	5÷10						
K4		☆	≤10	☆	≤10	☆	≤10										
N1																	
N2		☆	10÷20	☆	10÷30	☆	10÷30	☆	5÷10	☆	5÷10	☆	5÷10	☆	≤5		
N3						☆	5÷10	☆	5÷10	☆	5÷10						
N4		★	10÷20	★	10÷30	★	10÷30	☆	5÷10	☆	5÷10	☆	5÷10	☆	≤5		
N5																	
S1 (<25 HRC)																	
S2 (<35 HRC)																	
S3 (35 ÷ 45 HRC)																	
S5																	
H (45 ÷ 55 HRC)																	
H (55 ÷ 63 HRC)																	

★ 1st choice ☆ suitable

GP General Purpose				MS Material Specific										
NPS		NPSF		EH-HT	PMST	ZELX MOLD	SU-HT	GG-HT	GG-HT TiCN					
HSS-E	OX	HSS-E	OX	HSS-Co	HSS-P	OX	HSS-Co	HSS-E	OX	HSS-E	NI	HSS-E	COATING	
ANSI	ANSI	DIN	DIN	ANSI	JIS	DIN	DIN							
		275				279	281	M						
		275				279	281	MF						
				345	326			UNC/UNF						
								UNS, 8, 12, 20, 32UN						
								UNEF						
		275				279	281	G (BSP)						
								Rp (BSPP)						
				277				Rc (BSPT)						
								NPT						
								NPTF						
342	343							NPSC, NPSM, NPSF						
								BSW						
								EG(STI), M, MF, UNC/UNF						
								Pg						
								Tr						
								S miniature						
								Special threads						
Vc (m/min)														
☆	5÷10	☆	5÷10											P1
★	5÷10	★	5÷10					☆	≤5					P2
☆	≤5	☆	≤5		★	≤5		☆	≤5					P3
☆	≤5	☆	≤5		★	≤5		☆	≤5					P4
		★	≤5	★	≤5	★	≤5							P5
		★	≤5	★	≤5	★	≤5							P6
								★	≤5					P7
														P8
								★	≤5					M1
														M2
														M3
								★	5÷10	★	5÷20			K1
		☆	≤5		☆	≤5		★	5÷10	★	5÷20			K2
		☆	≤5		☆	≤5		★	≤5	★	≤10			K3
								☆	≤5	☆	≤10			K4
														N1
								☆	5÷15	☆	10÷20			N2
														N3
								★	5÷15	★	10÷20			N4
														N5
														S1 (<25 HRC)
														S2 (<35 HRC)
														S3 (35 ÷ 45 HRC)
														S5
														H (45 ÷ 55 HRC)
														H (55 ÷ 63 HRC)

Intro

SP

SL

PO

ST

ROLL

CARBIDE

LONG

HAND TAPS

EG (STI)

SPECIAL THREADS, GAUGES

THREAD MILLS

DIES

CENTER DRILLS

Technical info

Selection Chart

- Intro
- SP
- SL
- PO
- ST
- ROLL
- CARBIDE
- LONG
- HAND TAPS
- EG (STI)
- SPECIAL THREADS, GAUGES
- THREAD MILLS
- DIES
- CENTER DRILLS
- Technical info

MS Material Specific						
GG-HT-OH TiCN	LA-HT		AXE-HT		MG-HT	PL1
HSS-E COATING	HSS-E NI	HSS-P	COATING	HSS-E	HSS-E NI	
						
						
DIN						
M	283	DIN 285	JIS 329	287	JIS 331	JIS 333
MF	283		329	287		
UNC/UNF						
UNS, 8, 12, 20, 32UN						
UNEF						
G (BSP)						
Rp (BSPP)						
Rc (BSPT)						
NPT						
NPTF						
NPSC, NPSM, NPSF						
BSW						
EG(STI), M, MF, UNC/UNF						
Pg						
Tr						
S miniature						
Special threads						
Vc (m/min)						
P1						
P2						
P3						
P4						
P5						
P6						
P7						
P8						
M1						
M2						
M3						
K1	★ 10÷30			☆ 10÷20		
K2	★ 10÷30					
K3	★ ≤15					
K4	☆ ≤10					
N1		★ 5÷15		☆ 10÷20	★ 5÷15	
N2	☆ 10÷30	★ 5÷15		★ 10÷20	★ 5÷15	
N3		★ 5÷10				
N4	★ 10÷30	★ 5÷10		★ 10÷20		
N5						★ 5÷10
S1 (<25 HRC)						
S2 (<35 HRC)						
S3 (35 ÷ 45 HRC)						
S5						
H (45 ÷ 55 HRC)						
H (55 ÷ 63 HRC)						

★ 1st choice ☆ suitable

Intro

SP

SL

PO

ST

ROLL

CARBIDE

LONG

HAND
TAPS

EG (STI)

SPECIAL
THREADS,
GAUGES

THREAD
MILLS

DIES

CENTER
DRILLS

Technical
info

Intro

GGST

Z-PRO Series

SP Straight Fluted Taps for Cast Iron, Coated

SL



PO

Recommended Tapping Speeds Depending On Materials

ISO	Vc (m/min)	ISO	Vc (m/min)
K1	5÷20 ★	N2	10÷20 ☆
K2	5÷20 ★	N4	10÷20 ★
K3	≤10 ★		
K4	≤10 ☆		

★ 1st choice ☆ suitable

ST

DIN

ROLL

CARBIDE

LONG

HAND TAPS

EG (STI)

SPECIAL THREADS, GAUGES

THREAD MILLS

DIES

CENTER DRILLS

Technical info





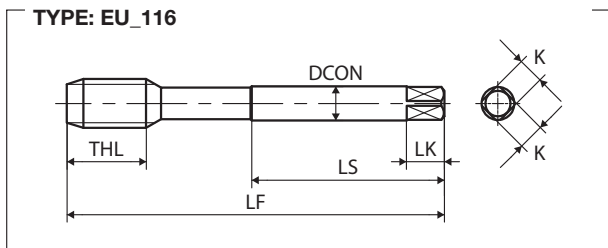
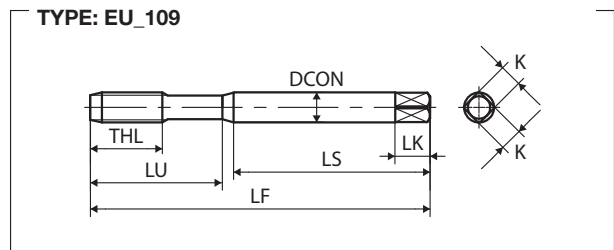
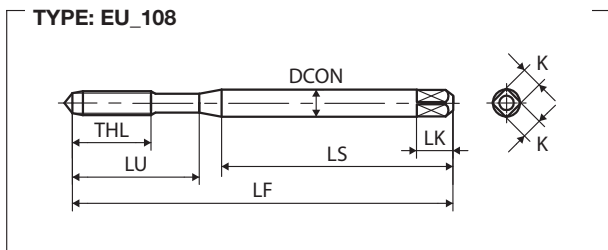

FEATURES

Material specific for blind and through hole application.
 Specific design for best performance on cast iron application.
 Special coating allows stable and long life even at high speed.

Availability related to GG-HT TiCN stock exhaustion



M	TCTR (tolerance)	 Hole Ø (mm)	Hole Ø (mm)	Code	THCHT (chamfer)	LF (mm)	THL (mm)	LU (mm)	LS (mm)	DCON (mm)	K (mm)	LK (mm)	NOF	Type	Stock
DIN 371															
M3X0.5	ISO2X(6HX)	2.5	2.56	3104101035	2.5P	56	9	18	34	3.5	2.7	6	3	108	○
M4X0.7	ISO2X(6HX)	3.3	3.38	3104101042	2.5P	63	13	21	38	4.5	3.4	6	4	108	●
M5X0.8	ISO2X(6HX)	4.2	4.28	3104101049	2.5P	70	14	25	39	6	4.9	8	4	108	●
M6X1	ISO2X(6HX)	5	5.09	3104101055	2.5P	80	15	30	45	6	4.9	8	4	108	●
M8X1.25	ISO2X(6HX)	6.8	6.85	3104101064	2.5P	90	19	35	47	8	6.2	9	4	109	●
M10X1.5	ISO2X(6HX)	8.5	8.6	3104101078	2.5P	100	23	39	52	10	8	11	4	109	●
M	TCTR (tolerance)	 Hole Ø (mm)	Hole Ø (mm)	Code	THCHT (chamfer)	LF (mm)	THL (mm)	LU (mm)	LS (mm)	DCON (mm)	K (mm)	LK (mm)	NOF	Type	Stock
DIN 376															
M12X1.75	ISO2X(6HX)	10.3	10.36	3104101088	2.5P	110	26	-	56	9	7	10	4	116	●
M14X2	ISO2X(6HX)	12	12.12	3104101100	2.5P	110	26	-	56	11	9	12	4	116	●
M16X2	ISO2X(6HX)	14	14.12	3104101114	2.5P	110	26	-	56	12	9	12	4	116	●
M18X2.5	ISO2X(6HX)	15.5	15.63	3104101128	2.5P	125	33	-	64	14	11	14	4	116	●
M20X2.5	ISO2X(6HX)	17.5	17.63	3104101141	2.5P	140	33	-	71	16	12	15	4	116	●
M22X2.5	ISO2X(6HX)	19.5	19.63	3104101156	2.5P	140	33	-	71	18	14.5	17	4	116	●
M24X3	ISO2X(6HX)	21	21.13	3104101167	2.5P	160	37	-	82	18	14.5	17	4	116	●
MF	TCTR (tolerance)	 Hole Ø (mm)	Hole Ø (mm)	Code	THCHT (chamfer)	LF (mm)	THL (mm)	LU (mm)	LS (mm)	DCON (mm)	K (mm)	LK (mm)	NOF	Type	Stock
DIN 374															
M8X1	ISO2X(6HX)	7	7.09	3104101065	2.5P	90	19	-	46	6	4.9	8	4	116	●
M10X1.25	ISO2X(6HX)	8.8	8.85	3104101079	2.5P	100	23	-	51	7	5.5	8	4	116	●
M10X1	ISO2X(6HX)	9	9.09	3104101080	2.5P	90	19	-	46	7	5.5	8	4	116	●
M12X1.5	ISO2X(6HX)	10.5	10.6	3104101089	2.5P	100	21	-	51	9	7	10	4	116	●
M12X1.25	ISO2X(6HX)	10.8	10.85	3104101090	2.5P	100	21	-	51	9	7	10	4	116	●
M12X1	ISO2X(6HX)	11	11.09	3104101091	2.5P	100	21	-	51	9	7	10	4	116	○
M14X1.5	ISO2X(6HX)	12.5	12.6	3104101102	2.5P	100	21	-	51	11	9	12	4	116	●
M16X1.5	ISO2X(6HX)	14.5	14.6	3104101116	2.5P	100	21	-	51	12	9	12	4	116	●
M18X1.5	ISO2X(6HX)	16.5	16.6	3104101130	2.5P	110	24	-	56	14	11	14	4	116	●
M20X1.5	ISO2X(6HX)	18.5	18.6	3104101144	2.5P	125	24	-	64	16	12	15	4	116	●
M22X1.5	ISO2X(6HX)	20.5	20.6	3104101158	2.5P	125	24	-	64	18	14.5	17	4	116	●
M24X1.5	ISO2X(6HX)	22.5	22.6	3104101170	2.5P	140	27	-	71	18	14.5	17	4	116	●
G(BSP)	TCTR (tolerance)	 Hole Ø (mm)	Hole Ø (mm)	Code	THCHT (chamfer)	Basic major Ø (mm)	LF (mm)	THL (mm)	LS (mm)	DCON (mm)	K (mm)	LK (mm)	NOF	Type	Stock
DIN 5156															
1/8-28	-	8.75	8.78	3104130004	2.5P	9.728	90	19	46	7	5.5	8	4	116	●
1/4-19	-	11.75	11.78	3104130006	2.5P	13.157	100	21	51	11	9	12	4	116	●
3/8-19	-	15.25	15.28	3104130008	2.5P	16.662	100	21	51	12	9	12	4	116	●
1/2-14	-	19	19.04	3104130009	2.5P	20.955	125	24	64	16	12	15	4	116	●
3/4-14	-	24.5	24.52	3104130011	2.5P	26.441	140	27	71	20	16	19	4	116	○
1-11	-	30.75	30.77	3104130013	2.5P	33.249	160	29	82	25	20	23	4	116	○

Intro

SP

SL

PO

ST

DIN

ROLL

CARBIDE

LONG

HAND
TAPS

EG (STI)

SPECIAL
THREADS,
GAUGES

THREAD
MILLS

DIES

CENTER
DRILLS

Technical
info

Intro

GGST CH



SP

Z-PRO Series

Straight Fluted Taps for Cast Iron with Axial Coolant Hole, Coated

SL



PO

Recommended Tapping Speeds Depending On Materials

ISO	Vc (m/min)		ISO	Vc (m/min)	
K1	10÷30	★	N2	10÷30	☆
K2	10÷30	★	N4	10÷30	★
K3	≤15	★			
K4	≤10	☆			

★ 1st choice ☆ suitable

ST

DIN

ROLL

CARBIDE

LONG

HAND TAPS

EG (STI)

SPECIAL THREADS, GAUGES

THREAD MILLS

DIES

CENTER DRILLS

Technical info

FEATURES

Material specific with axial oil hole for blind hole application.

Specific design for best performance on cast iron application.

Special coating allows stable and long life even at high speed.

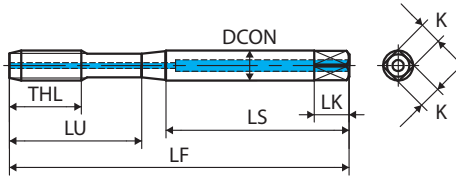

Availability related to GG-HT-OH TiCN stock exhaustion

TYPE: EU_110

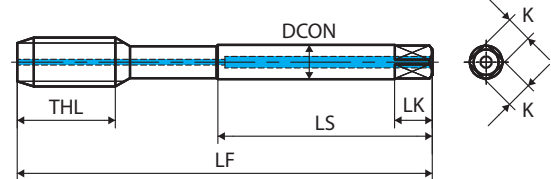

TYPE: EU_114



M	TCTR (tolerance)	 Hole Ø (mm)	Hole Ø (mm)	Code	THCHT (chamfer)	LF (mm)	THL (mm)	LU (mm)	LS (mm)	DCON (mm)	K (mm)	LK (mm)	NOF	Type	Stock
DIN 371															
M6X1	ISO2X(6HX)	5	5.09	3205101055	2.5P	80	15	30	45	6	4.9	8	4	110	●
M8X1.25	ISO2X(6HX)	6.8	6.85	3205101064	2.5P	90	19	35	47	8	6.2	9	4	110	●
M10X1.5	ISO2X(6HX)	8.5	8.6	3205101078	2.5P	100	23	39	52	10	8	11	4	110	●
M	TCTR (tolerance)	 Hole Ø (mm)	Hole Ø (mm)	Code	THCHT (chamfer)	LF (mm)	THL (mm)	LU (mm)	LS (mm)	DCON (mm)	K (mm)	LK (mm)	NOF	Type	Stock
DIN 376															
M12X1.75	ISO2X(6HX)	10.3	10.36	3205101088	2.5P	110	26	-	56	9	7	10	4	114	●
M14X2	ISO2X(6HX)	12	12.12	3205101100	2.5P	110	26	-	56	11	9	12	4	114	●
M16X2	ISO2X(6HX)	14	14.12	3205101114	2.5P	110	26	-	56	12	9	12	4	114	●
M18X2.5	ISO2X(6HX)	15.5	15.63	3205101128	2.5P	125	33	-	64	14	11	14	4	114	○
M20X2.5	ISO2X(6HX)	17.5	17.63	3205101141	2.5P	140	33	-	71	16	12	15	4	114	●
MF	TCTR (tolerance)	 Hole Ø (mm)	Hole Ø (mm)	Code	THCHT (chamfer)	LF (mm)	THL (mm)	LU (mm)	LS (mm)	DCON (mm)	K (mm)	LK (mm)	NOF	Type	Stock
DIN 374															
M8X1	ISO2X(6HX)	7	7.09	3205101065	2.5P	90	19	-	46	6	4.9	8	4	114	●
M10X1.25	ISO2X(6HX)	8.8	8.85	3205101079	2.5P	100	23	-	51	7	5.5	8	4	114	●
M10X1	ISO2X(6HX)	9	9.09	3205101080	2.5P	90	19	-	46	7	5.5	8	4	114	●
M12X1.5	ISO2X(6HX)	10.5	10.6	3205101089	2.5P	100	21	-	51	9	7	10	4	114	●
M12X1.25	ISO2X(6HX)	10.8	10.85	3205101090	2.5P	100	21	-	51	9	7	10	4	114	●
M14X1.5	ISO2X(6HX)	12.5	12.6	3205101102	2.5P	100	21	-	51	11	9	12	4	114	●
M16X1.5	ISO2X(6HX)	14.5	14.6	3205101116	2.5P	100	21	-	51	12	9	12	4	114	●
M18X1.5	ISO2X(6HX)	16.5	16.6	3205101130	2.5P	110	24	-	56	14	11	14	4	114	●
M20X1.5	ISO2X(6HX)	18.5	18.6	3205101144	2.5P	125	24	-	64	16	12	15	4	114	●

Intro

SP

SL

PO

ST

DIN

ROLL

CARBIDE

LONG

HAND
TAPS

EG (STI)

SPECIAL
THREADS,
GAUGESTHREAD
MILLS

DIES

CENTER
DRILLSTechnical
info

Intro

GGST CH E(1.5P)



Z-PRO Series

SP Straight Fluted Taps 1.5P, for Cast Iron with Axial Coolant Hole, Coated

SL



PO

Recommended Tapping Speeds Depending On Materials

ISO	Vc (m/min)		ISO	Vc (m/min)	
K1	10÷30	★	N2	10÷30	☆
K2	10÷30	★	N4	10÷30	★
K3	≤15	★			
K4	≤10	☆			

★ 1st choice ☆ suitable

ST

DIN

ROLL

CARBIDE

LONG

HAND TAPS

EG (STI)

SPECIAL THREADS, GAUGES

THREAD MILLS

DIES

CENTER DRILLS

Technical info

FEATURES

Material specific with axial oil hole and extra short chamfer (1.5P) for blind hole application.

Specific design for best performance on cast iron application.

Special coating allows stable and long life even at higher speed.

TYPE: EU_110

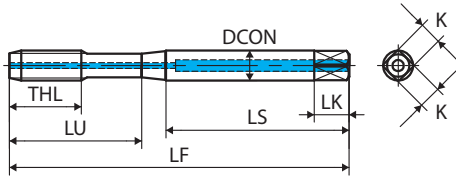

TYPE: EU_114

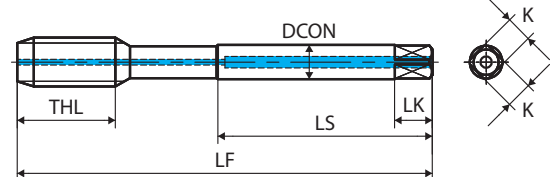

M	TCTR (tolerance)	 Hole Ø (mm)	Hole Ø (mm)	Code	THCHT (chamfer)	LF (mm)	THL (mm)	LU (mm)	LS (mm)	DCON (mm)	K (mm)	LK (mm)	NOF	Type	Stock
DIN 371															
M6X1	ISO2X(6HX)	5	5.09	3206101055	1.5P	80	15	30	45	6	4.9	8	4	110	●
M7x1	ISO2X(6HX)	6	6.09	3206101060	1.5P	80	15	30	45	7	5.5	8	4	110	○
M8X1.25	ISO2X(6HX)	6.8	6.85	3206101064	1.5P	90	19	35	47	8	6.2	9	4	110	●
M10X1.5	ISO2X(6HX)	8.5	8.6	3206101078	1.5P	100	23	39	52	10	8	11	4	110	●
DIN 376															
M12X1.75	ISO2X(6HX)	10.3	10.36	3206101088	1.5P	110	26	-	56	9	7	10	4	114	●
M14X2	ISO2X(6HX)	12	12.12	3206101100	1.5P	110	26	-	56	11	9	12	4	114	○
M16X2	ISO2X(6HX)	14	14.12	3206101114	1.5P	110	26	-	56	12	9	12	4	114	○
DIN 374															
M10X1.25	ISO2X(6HX)	8.8	8.85	3206101079	1.5P	100	23	-	51	7	5.5	8	4	114	○
M10X1	ISO2X(6HX)	9	9.09	3206101080	1.5P	90	19	-	46	7	5.5	8	4	114	○
M12X1.5	ISO2X(6HX)	10.5	10.6	3206101089	1.5P	100	21	-	51	9	7	10	4	114	●
M12X1.25	ISO2X(6HX)	10.8	10.85	3206101090	1.5P	100	21	-	51	9	7	10	4	114	○
M14X1.5	ISO2X(6HX)	12.5	12.6	3206101102	1.5P	100	21	-	51	11	9	12	4	114	○
M16X1.5	ISO2X(6HX)	14.5	14.6	3206101116	1.5P	100	21	-	51	12	9	12	4	114	○

Intro

SP

SL

PO

ST

DIN

ROLL

CARBIDE

LONG

HAND TAPS

EG (STI)

SPECIAL THREADS, GAUGES

THREAD MILLS

DIES

CENTER DRILLS

Technical info

Straight Fluted Taps

Intro

HT

GP General Purpose Series

Straight Fluted Taps



SP

SL



FEATURES

General purpose for blind and through hole application.
For steel application at low cutting speed, also suitable for cast iron and non-ferrous materials.

PO

Recommended Tapping Speeds Depending On Materials

ISO	Vc (m/min)	ISO	Vc (m/min)	ISO	Vc (m/min)
P1	5÷10 ☆	K1	5÷10 ☆	N2	5÷10 ☆
P2	5÷10 ★	K2	5÷10 ☆	N3	5÷10 ☆
P3	5÷10 ☆	K3	5÷10 ☆	N4	5÷10 ☆
P4	5÷10 ☆				

ST

DIN

★ 1st choice ☆ suitable

ROLL

CARBIDE

LONG

HAND TAPS

EG (STI)

SPECIAL THREADS, GAUGES

THREAD MILLS

DIES

CENTER DRILLS

Technical info

TYPE: EU_108

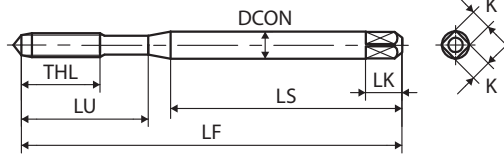

TYPE: EU_109

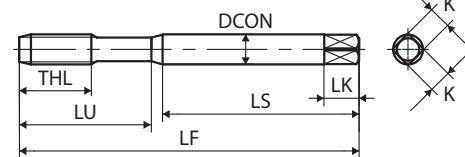

TYPE: EU_116

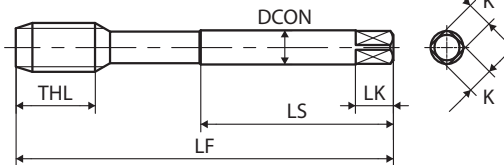

TYPE: EU_057

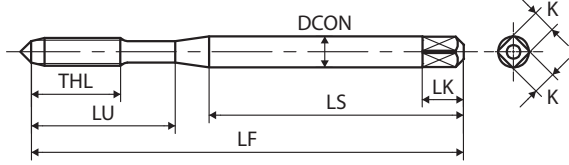

Intro

M	TCTR (tolerance)	 Hole Ø (mm)	Hole Ø (mm)	Code	THCHT (chamfer)	LF (mm)	THL (mm)	LU (mm)	LS (mm)	DCON (mm)	K (mm)	LK (mm)	NOF	Type	Stock
DIN 371															
M3X0.5	ISO2(6H)	2.5	2.56	TD3.0GANEB	2.5P	56	9	18	34	3.5	2.7	6	3	108	○
M4X0.7	ISO2(6H)	3.3	3.38	TD4.0IANEB	2.5P	63	13	21	38	4.5	3.4	6	3	108	○
M5X0.8	ISO2(6H)	4.2	4.28	TD5.0KANEB	2.5P	70	14	25	39	6	4.9	8	3	108	○
M6X1	ISO2(6H)	5	5.09	TD6.0MANEB	2.5P	80	15	30	45	6	4.9	8	3	108	○
M8X1.25	ISO2(6H)	6.8	6.85	TD8.0NANEB	2.5P	90	19	35	47	8	6.2	9	3	109	○
M10X1.5	ISO2(6H)	8.5	8.6	TD10.0OANEB	2.5P	100	23	39	52	10	8	11	3	109	○

SP

SL

M	TCTR (tolerance)	 Hole Ø (mm)	Hole Ø (mm)	Code	THCHT (chamfer)	LF (mm)	THL (mm)	LU (mm)	LS (mm)	DCON (mm)	K (mm)	LK (mm)	NOF	Type	Stock
DIN 376															
M12X1.75	ISO2(6H)	10.3	10.36	TG012PANEB	2.5P	110	26	-	56	9	7	10	3	116	○
M14X2	ISO2(6H)	12	12.12	TG014QANEB	2.5P	110	26	-	56	11	9	12	3	116	○
M16X2	ISO2(6H)	14	14.12	TG016QANEB	2.5P	110	26	-	56	12	9	12	3	116	○
M20X2.5	ISO2(6H)	17.5	17.63	TG020RANEB	2.5P	140	33	-	71	16	12	15	3	116	○
M24X3	ISO2(6H)	21	21.13	TG024SANEB	2.5P	160	37	-	82	18	14.5	17	3	116	○

PO

ST

DIN

MF	TCTR (tolerance)	 Hole Ø (mm)	Hole Ø (mm)	Code	THCHT (chamfer)	LF (mm)	THL (mm)	LU (mm)	LS (mm)	DCON (mm)	K (mm)	LK (mm)	NOF	Type	Stock
DIN 374															
M8X1	ISO2(6H)	7	7.09	TM8.0MANEB	2.5P	90	19	-	46	6	4.9	8	3	116	○
M10X1.25	ISO2(6H)	8.8	8.85	TM010NANEB	2.5P	100	23	-	51	7	5.5	8	3	116	○
M10X1	ISO2(6H)	9	9.09	TM010MANEB	2.5P	90	19	-	46	7	5.5	8	3	116	○
M12X1.5	ISO2(6H)	10.5	10.6	TM012OANEB	2.5P	100	21	-	51	9	7	10	3	116	○
M12X1.25	ISO2(6H)	10.8	10.85	TM012NANEB	2.5P	100	21	-	51	9	7	10	3	116	○
M12X1	ISO2(6H)	11	11.09	TM012MANEB	2.5P	100	21	-	51	9	7	10	3	116	○
M14X1.5	ISO2(6H)	12.5	12.6	TM014OANEB	2.5P	100	21	-	51	11	9	12	3	116	○
M16X1.5	ISO2(6H)	14.5	14.6	TM016OANEB	2.5P	100	21	-	51	12	9	12	3	116	○

ROLL

CARBIDE

LONG

UNC	TCTR (tolerance)	 Hole Ø (mm)	Hole Ø (mm)	Code	THCHT (chamfer)	LF (mm)	THL (mm)	LU (mm)	LS (mm)	DCON (mm)	K (mm)	LK (mm)	NOF	Type	Stock
DIN 371															
1/4-20UNC	2B	5.1	5.19	TDU04NXNEB	2.5P	80	15	30	42	7	5.5	8	3	057	○
5/16-18UNC	2B	6.6	6.65	TDU050XNEB	2.5P	90	19	35	47	8	6.2	9	4	057	○
3/8-16UNC	2B	8	8.07	TDU06PXNEB	2.5P	100	23	39	54	10	7	10	4	109	○

HAND TAPS

EG (STI)

UNC	TCTR (tolerance)	 Hole Ø (mm)	Hole Ø (mm)	Code	THCHT (chamfer)	LF (mm)	THL (mm)	LU (mm)	LS (mm)	DCON (mm)	K (mm)	LK (mm)	NOF	Type	Stock
DIN 376															
7/16-14UNC	2B	9.4	9.45	TGU07QXNEB	2.5P	100	23	-	51	8	6.2	9	4	116	○
1/2-13UNC	2B	10.9	10.91	TGU08RXNEB	2.5P	110	26	-	56	9	7	10	4	116	○
9/16-12UNC	2B	12.2	12.33	TGU09SXNEB	2.5P	110	26	-	56	11	9	12	4	116	○
5/8-11UNC	2B	13.6	13.75	TGU10UXNEB	2.5P	110	26	-	56	12	9	12	4	116	○
3/4-10UNC	2B	16.6	16.7	TGU12VXNEB	2.5P	125	33	-	64	14	11	14	4	116	○
7/8-9UNC	2B	19.6	19.61	TGU14WXNEB	2.5P	140	33	-	71	18	14.5	17	4	116	○
1-8UNC	2B	22.3	22.45	TGU16XXNEB	2.5P	160	37	-	82	18	14.5	17	4	116	○

SPECIAL THREADS, GAUGES

THREAD MILLS

UNF	TCTR (tolerance)	 Hole Ø (mm)	Hole Ø (mm)	Code	THCHT (chamfer)	LF (mm)	THL (mm)	LU (mm)	LS (mm)	DCON (mm)	K (mm)	LK (mm)	NOF	Type	Stock
DIN 371															
1/4-28UNF	2B	5.5	5.53	TDU04KXNEB	2.5P	80	15	30	42	7	5.5	8	3	057	○



DIES

CENTER DRILLS

Technical info

Straight Fluted Taps

Intro

	UNF	TCTR (tolerance)	 Hole Ø (mm)	Hole Ø (mm)	Code	THCHT (chamfer)	LF (mm)	THL (mm)	LU (mm)	LS (mm)	DCON (mm)	K (mm)	LK (mm)	NOF	Type	Stock
	DIN 374															
SP	5/16-24UNF	2B	6.9	6.97	TMU05MXNEBC	2.5P	90	19	-	46	6	4.9	8	4	116	○
	3/8-24UNF	2B	8.5	8.57	TMU06MXNEBC	2.5P	100	23	-	51	7	5.5	8	4	116	○
	7/16-20UNF	2B	9.9	9.96	TMU07NXNEBC	2.5P	100	23	-	51	8	6.2	9	4	116	○
SL	1/2-20UNF	2B	11.5	11.54	TMU08NXNEBC	2.5P	100	21	-	51	9	7	10	4	116	○
	9/16-18UNF	2B	12.9	13	TMU090XNEBC	2.5P	100	21	-	51	11	9	12	4	116	○
	5/8-18UNF	2B	14.5	14.6	TMU100XNEBC	2.5P	100	21	-	51	12	9	12	4	116	○
PO	3/4-16UNF	2B	17.5	17.59	TMU12PXNEBC	2.5P	110	24	-	56	14	11	14	4	116	○
	7/8-14UNF	2B	20.5	20.57	TMU14QXNEBC	2.5P	125	24	-	64	18	14.5	17	4	116	○
	1-12UNF	2B	23.3	23.46	TMU16SXNEBC	2.5P	140	27	-	71	18	14.5	17	4	116	○
	G(BSP)	TCTR (tolerance)	 Hole Ø (mm)	Hole Ø (mm)	Code	THCHT (chamfer)	Basic major Ø (mm)	LF (mm)	THL (mm)	LS (mm)	DCON (mm)	K (mm)	LK (mm)	NOF	Type	Stock
	DIN 5156															
ST	1/8-28	-	8.75	8.78	TVG0020NEBC	2.5P	9.728	90	19	46	7	5.5	8	3	116	○
DIN	1/4-19	-	11.75	11.78	TVG0040NEBC	2.5P	13.157	100	21	51	11	9	12	3	116	○
	3/8-19	-	15.25	15.28	TVG0060NEBC	2.5P	16.662	100	21	51	12	9	12	3	116	○
ROLL	1/2-14	-	19	19.04	TVG0080NEBC	2.5P	20.955	125	24	64	16	12	15	3	116	○
	3/4-14	-	24.5	24.52	TVG0120NEBC	2.5P	26.441	140	27	71	20	16	19	4	116	○
	1-11	-	30.75	30.77	TVG0160NEBC	2.5P	33.249	160	29	82	25	20	23	4	116	○

CARBIDE

LONG

HAND
TAPS

EG (STI)

SPECIAL
THREADS,
GAUGES

THREAD
MILLS

DIES

CENTER
DRILLS

Technical
info

Intro

SP

SL

PO

ST

DIN

ROLL

CARBIDE

LONG

HAND
TAPS

EG (STI)

SPECIAL
THREADS,
GAUGES

THREAD
MILLS

DIES

CENTER
DRILLS

Technical
info

Intro

EH-HT

MS Material Specific Series

Straight Fluted Taps for Hard Materials (<45HRC)

SP

SL



PO

Recommended Tapping Speeds Depending On Materials

ISO	Vc (m/min)		ISO	Vc (m/min)	
P5	≤5	★	K2	≤5	☆
P6	≤5	★	K3	≤5	☆

★ 1st choice ☆ suitable

ST

DIN

ROLL

CARBIDE

LONG

HAND TAPS

EG (STI)

SPECIAL THREADS, GAUGES

THREAD MILLS

DIES

CENTER DRILLS

Technical info



FEATURES

Material specific for blind and through hole application.
For high tensile strength steel <45HRC.
Specific geometry and HSSCo substrate allow stable and long life.

TYPE: EU_108

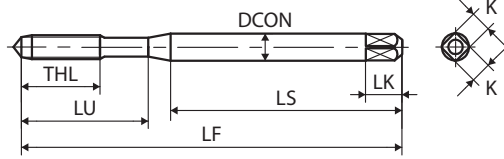



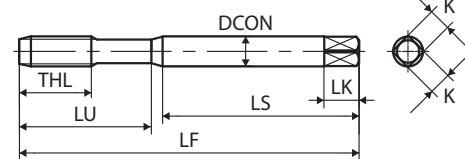

TYPE: EU_109

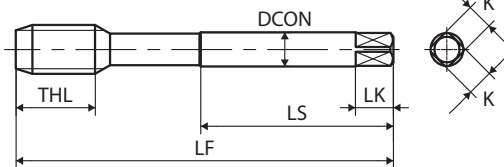

TYPE: EU_116



M	TCTR (tolerance)	 Hole Ø (mm)	Hole Ø (mm)	Code	THCHT (chamfer)	LF (mm)	THL (mm)	LU (mm)	LS (mm)	DCON (mm)	K (mm)	LK (mm)	NOF	Type	Stock
DIN 371															
M3X0.5	ISO2X(6HX)	2.5	2.56	TD3.0GBDCBC	2.5P	56	9	18	34	3.5	2.7	6	3	108	●
M4X0.7	ISO2X(6HX)	3.3	3.38	TD4.0IBDCBC	2.5P	63	13	21	38	4.5	3.4	6	3	108	●
M5X0.8	ISO2X(6HX)	4.2	4.28	TD5.0KBDCBC	2.5P	70	14	25	39	6	4.9	8	3	108	●
M6X1	ISO2X(6HX)	5	5.09	TD6.0MBDCBC	2.5P	80	15	30	45	6	4.9	8	3	108	●
M8X1.25	ISO2X(6HX)	6.8	6.85	TD8.0NBDCBC	2.5P	90	19	35	47	8	6.2	9	4	109	●
M10X1.5	ISO2X(6HX)	8.5	8.6	TD0100BDCBC	2.5P	100	23	39	52	10	8	11	4	109	●
M	TCTR (tolerance)	 Hole Ø (mm)	Hole Ø (mm)	Code	THCHT (chamfer)	LF (mm)	THL (mm)	LU (mm)	LS (mm)	DCON (mm)	K (mm)	LK (mm)	NOF	Type	Stock
DIN 376															
M12X1.75	ISO2X(6HX)	10.3	10.36	TG012PBDCBC	2.5P	110	26	-	56	9	7	10	4	116	●
M14X2	ISO2X(6HX)	12	12.12	TG014QBDCBC	2.5P	110	26	-	56	11	9	12	4	116	●
M16X2	ISO2X(6HX)	14	14.12	TG016QBDCBC	2.5P	110	26	-	56	12	9	12	4	116	●
M18X2.5	ISO2X(6HX)	15.5	15.63	TG018RBDCBC	2.5P	125	33	-	64	14	11	14	4	116	○
M20X2.5	ISO2X(6HX)	17.5	17.63	TG020RBDCBC	2.5P	140	33	-	71	16	12	15	4	116	●
M24X3	ISO2X(6HX)	21	21.13	TG024SBDCBC	2.5P	160	37	-	82	18	14.5	17	4	116	●
MF	TCTR (tolerance)	 Hole Ø (mm)	Hole Ø (mm)	Code	THCHT (chamfer)	LF (mm)	THL (mm)	LU (mm)	LS (mm)	DCON (mm)	K (mm)	LK (mm)	NOF	Type	Stock
DIN 374															
M8X1	ISO2X(6HX)	7	7.09	TM8.0MBDCBC	2.5P	90	19	-	46	6	4.9	8	4	116	▽
M10X1.25	ISO2X(6HX)	8.8	8.85	TM010NBDCBC	2.5P	100	23	-	51	7	5.5	8	4	116	▽
M10X1	ISO2X(6HX)	9	9.09	TM010MBDCBC	2.5P	90	19	-	46	7	5.5	8	4	116	▽
M12X1.5	ISO2X(6HX)	10.5	10.6	TM0120BDCBC	2.5P	100	21	-	51	9	7	10	4	116	▽
M12X1.25	ISO2X(6HX)	10.8	10.85	TM012NBDCBC	2.5P	100	21	-	51	9	7	10	4	116	▽
M14X1.5	ISO2X(6HX)	12.5	12.6	TM0140BDCBC	2.5P	100	21	-	51	11	9	12	4	116	▽
M16X1.5	ISO2X(6HX)	14.5	14.6	TM0160BDCBC	2.5P	100	21	-	51	12	9	12	4	116	▽
G(BSP)	TCTR (tolerance)	 Hole Ø (mm)	Hole Ø (mm)	Code	THCHT (chamfer)	Basic major Ø (mm)	LF (mm)	THL (mm)	LS (mm)	DCON (mm)	K (mm)	LK (mm)	NOF	Type	Stock
DIN 5156															
1/8-28	-	8.75	8.78	TVG0020DCBC	2.5P	9.728	90	19	46	7	5.5	8	4	116	●
1/4-19	-	11.75	11.78	TVG0040DCBC	2.5P	13.157	100	21	51	11	9	12	4	116	●
3/8-19	-	15.25	15.28	TVG0060DCBC	2.5P	16.662	100	21	51	12	9	12	4	116	●
1/2-14	-	19	19.04	TVG0080DCBC	2.5P	20.955	125	24	64	16	12	15	4	116	●

Intro

SP

SL

PO

ST
DIN

ROLL

CARBIDE

LONG

HAND
TAPS

EG (STI)

SPECIAL
THREADS,
GAUGES

THREAD
MILLS

DIES

CENTER
DRILLS

Technical
info

Intro

PMST

MS Material Specific Series

Straight Fluted Taps for Hard Materials (<45HRC)



SP

SL

PO

ST

DIN

ROLL

CARBIDE

LONG

HAND TAPS

EG (STI)

SPECIAL THREADS, GAUGES

THREAD MILLS

DIES

CENTER DRILLS

Technical info



Recommended Tapping Speeds Depending On Materials

ISO	Vc (m/min)	
P3	≤5	★
P4	≤5	★
P5	≤5	★
P6	≤5	★

★ 1st choice ☆ suitable

FEATURES

Material specific for blind and through hole application.

Specific design and premium grade HSSP for stable and long life on alloy steel and tool steel (30 ÷ 45HRC) application.

Reliable and high performance tapping for the mould&die industry.

Product Features

ISO	Materials	Hardness	Recommended tapping speed (Vc <5m/min)	5m/min
P6	High tensile strength steel	40÷45 HRC		
P5	Tool steel (100MnCrW4-1.2510, 40CrMnMo7-1.2311)	30÷40 HRC		
P4	High alloy steel (CrMo, NiCrMo)	25÷30 HRC		

Most Suitable (solid red line) Suitable (dashed red line)

Bored Hole Ø (mm) A - B

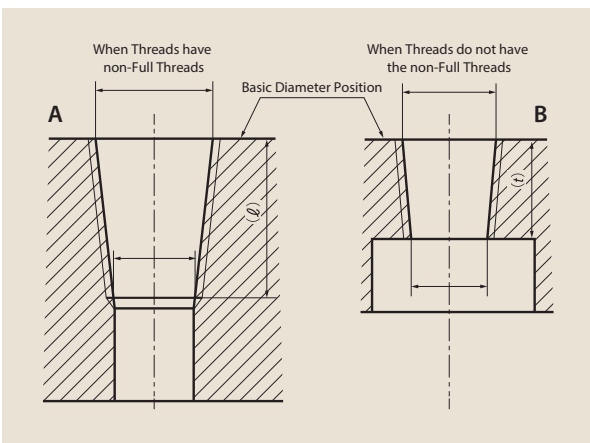

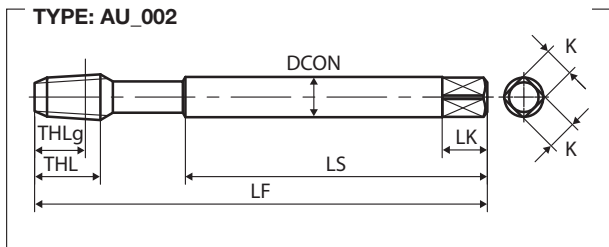

Rc(BSPT)	TCTR (tolerance)	Bored Hole Ø (mm)		Code	THCHT (chamfer)	Basic major Ø (mm)	LF (mm)	THL (mm)	THLg (mm)	LS (mm)	DCON (mm)	K (mm)	LK (mm)	NOF	Type	Stock
		A	B													
DIN YMW																
1/8-28	-	8.1	8.2	TJRC020DPX	2.5P	9.728	90	15	10.1	46	8	6	9	4	002	●
1/4-19	-	10.7	10.9	TJRC040DPX	2.5P	13.157	100	19	15	51	11	9	12	4	002	●
3/8-19	-	14.2	14.4	TJRC060DPX	2.5P	16.662	100	21	15.4	51	14	11	14	4	002	●
1/2-14	-	17.6	17.9	TJRC080DPX	2.5P	20.955	125	26	20.5	64	18	14	17	4	002	●
3/4-14	-	23	23.3	TJRC120DPX	2.5P	26.441	140	28	21.8	71	23	17	20	4	002	○
1-11	-	29	29.3	TJRC160DPX	2.5P	33.249	160	33	26	82	26	21	24	4	002	○

Intro

SP

SL

PO

ST

DIN

ROLL

CARBIDE

LONG

HAND
TAPS

EG (STI)

SPECIAL
THREADS,
GAUGES

THREAD
MILLS

DIES

CENTER
DRILLS

Technical
info

Intro

GG-HT

MS Material Specific Series

Straight Fluted Taps for Cast Iron

SP

SL



PO

Recommended Tapping Speeds Depending On Materials

ISO	Vc (m/min)		ISO	Vc (m/min)	
K1	5÷10	★	N2	5÷15	☆
K2	5÷10	★	N4	5÷15	★
K3	≤5	★			
K4	≤5	☆			

ST

DIN

★ 1st choice ☆ suitable

ROLL

CARBIDE

LONG

HAND TAPS

EG (STI)

SPECIAL THREADS, GAUGES

THREAD MILLS

DIES

CENTER DRILLS

Technical info



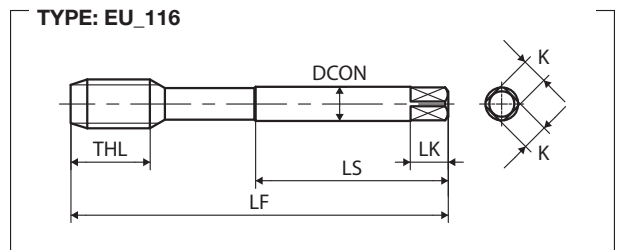
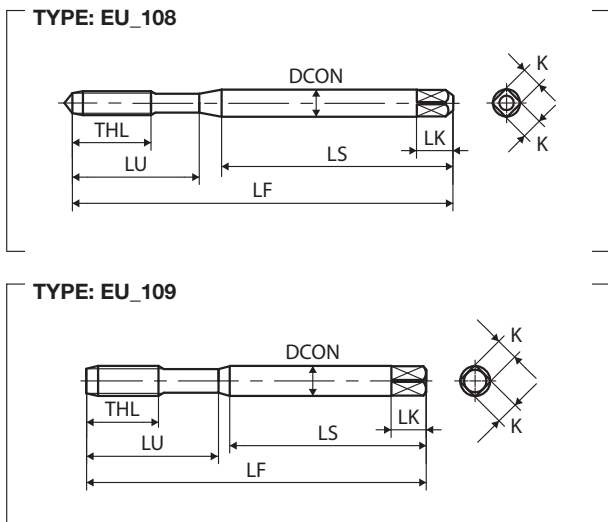

FEATURES

Material specific for blind and through hole application. Specific design and NI treatment for stable and long life on cast iron application.



M	TCTR (tolerance)	 Hole Ø (mm)	Hole Ø (mm)	Code	THCHT (chamfer)	LF (mm)	THL (mm)	LU (mm)	LS (mm)	DCON (mm)	K (mm)	LK (mm)	NOF	Type	Stock
DIN 371															
M3X0.5	ISO2X(6HX)	2.5	2.56	TD3.0GBAENC	2.5P	56	9	18	34	3.5	2.7	6	3	108	●
M4X0.7	ISO2X(6HX)	3.3	3.38	TD4.0IBAENC	2.5P	63	13	21	38	4.5	3.4	6	4	108	●
M5X0.8	ISO2X(6HX)	4.2	4.28	TD5.0KBAENC	2.5P	70	14	25	39	6	4.9	8	4	108	●
M6X1	ISO2X(6HX)	5	5.09	TD6.0MBAENC	2.5P	80	15	30	45	6	4.9	8	4	108	●
M8X1.25	ISO2X(6HX)	6.8	6.85	TD8.0NBAENC	2.5P	90	19	35	47	8	6.2	9	4	109	●
M10X1.5	ISO2X(6HX)	8.5	8.6	TD0100BAENC	2.5P	100	23	39	52	10	8	11	4	109	●

M	TCTR (tolerance)	 Hole Ø (mm)	Hole Ø (mm)	Code	THCHT (chamfer)	LF (mm)	THL (mm)	LU (mm)	LS (mm)	DCON (mm)	K (mm)	LK (mm)	NOF	Type	Stock
DIN 376															
M5X0.8	ISO2X(6HX)	4.2	4.28	TG5.0KBAENC	2.5P	70	14	-	-	3.5	2.7	6	4	116	○
M6X1	ISO2X(6HX)	5	5.09	TG6.0MBAENC	2.5P	80	15	-	-	4.5	3.4	6	4	116	○
M8X1.25	ISO2X(6HX)	6.8	6.85	TG8.0NBAENC	2.5P	90	19	-	46	6	4.9	8	4	116	●
M10X1.5	ISO2X(6HX)	8.5	8.6	TG0100BAENC	2.5P	100	23	-	51	7	5.5	8	4	116	●
M12X1.75	ISO2X(6HX)	10.3	10.36	TG012PBAENC	2.5P	110	26	-	56	9	7	10	4	116	●
M14X2	ISO2X(6HX)	12	12.12	TG014QBAENC	2.5P	110	26	-	56	11	9	12	4	116	●
M16X2	ISO2X(6HX)	14	14.12	TG016QBAENC	2.5P	110	26	-	56	12	9	12	4	116	●
M18X2.5	ISO2X(6HX)	15.5	15.63	TG018RBAENC	2.5P	125	33	-	64	14	11	14	4	116	●
M20X2.5	ISO2X(6HX)	17.5	17.63	TG020RBAENC	2.5P	140	33	-	71	16	12	15	4	116	●
M22X2.5	ISO2X(6HX)	19.5	19.63	TG022RBAENC	2.5P	140	33	-	71	18	14.5	17	4	116	●
M24X3	ISO2X(6HX)	21	21.13	TG024SBAENC	2.5P	160	37	-	82	18	14.5	17	4	116	●

MF	TCTR (tolerance)	 Hole Ø (mm)	Hole Ø (mm)	Code	THCHT (chamfer)	LF (mm)	THL (mm)	LU (mm)	LS (mm)	DCON (mm)	K (mm)	LK (mm)	NOF	Type	Stock
DIN 374															
M8X1	ISO2X(6HX)	7	7.09	TM8.0MBAENC	2.5P	90	19	-	46	6	4.9	8	4	116	●
M10X1.25	ISO2X(6HX)	8.8	8.85	TM010NBAENC	2.5P	100	23	-	51	7	5.5	8	4	116	●
M10X1	ISO2X(6HX)	9	9.09	TM010MBAENC	2.5P	90	19	-	46	7	5.5	8	4	116	●
M12X1.5	ISO2X(6HX)	10.5	10.6	TM0120BAENC	2.5P	100	21	-	51	9	7	10	4	116	●
M12X1.25	ISO2X(6HX)	10.8	10.85	TM012NBAENC	2.5P	100	21	-	51	9	7	10	4	116	●
M12X1	ISO2X(6HX)	11	11.09	TM012MBAENC	2.5P	100	21	-	51	9	7	10	4	116	●
M14X1.5	ISO2X(6HX)	12.5	12.6	TM0140BAENC	2.5P	100	21	-	51	11	9	12	4	116	●
M16X1.5	ISO2X(6HX)	14.5	14.6	TM0160BAENC	2.5P	100	21	-	51	12	9	12	4	116	●
M18X1.5	ISO2X(6HX)	16.5	16.6	TM0180BAENC	2.5P	110	24	-	56	14	11	14	4	116	●
M20X1.5	ISO2X(6HX)	18.5	18.6	TM0200BAENC	2.5P	125	24	-	64	16	12	15	4	116	●
M22X1.5	ISO2X(6HX)	20.5	20.6	TM0220BAENC	2.5P	125	24	-	64	18	14.5	17	4	116	●
M24X1.5	ISO2X(6HX)	22.5	22.6	TM0240BAENC	2.5P	140	27	-	71	18	14.5	17	4	116	●

G(BSP)	TCTR (tolerance)	 Hole Ø (mm)	Hole Ø (mm)	Code	THCHT (chamfer)	Basic major Ø (mm)	LF (mm)	THL (mm)	LS (mm)	DCON (mm)	K (mm)	LK (mm)	NOF	Type	Stock
DIN 5156															
1/8-28	-	8.75	8.78	TVG0020AENC	2.5P	9.728	90	19	46	7	5.5	8	4	116	●
1/4-19	-	11.75	11.78	TVG0040AENC	2.5P	13.157	100	21	51	11	9	12	4	116	●
3/8-19	-	15.25	15.28	TVG0060AENC	2.5P	16.662	100	21	51	12	9	12	4	116	●
1/2-14	-	19	19.04	TVG0080AENC	2.5P	20.955	125	24	64	16	12	15	4	116	●
3/4-14	-	24.5	24.52	TVG0120AENC	2.5P	26.441	140	27	71	20	16	19	4	116	●
1-11	-	30.75	30.77	TVG0160AENC	2.5P	33.249	160	29	82	25	20	23	4	116	●

Intro
SP
SL
PO
ST
DIN
ROLL
CARBIDE
LONG
HAND TAPS
EG (STI)
SPECIAL THREADS, GAUGES
THREAD MILLS
DIES
CENTER DRILLS
Technical info

Intro

GG-HT TiCN

MS Material Specific Series

Straight Fluted Taps for Cast Iron, Coated

SP

SL



PO

Recommended Tapping Speeds Depending On Materials

ISO	Vc (m/min)		ISO	Vc (m/min)	
K1	5÷20	★	N2	10÷20	☆
K2	5÷20	★	N4	10÷20	★
K3	≤10	★			
K4	≤10	☆			

★ 1st choice ☆ suitable

ST

DIN

ROLL

CARBIDE

LONG

HAND TAPS

EG (STI)

SPECIAL THREADS, GAUGES

THREAD MILLS

DIES

CENTER DRILLS

Technical info



FEATURES

Material specific for blind and through hole application.
 Specific design for best performance on cast iron application.
 Special coating allows stable and long life even at high speed.

This item will be gradually replaced by:

· GGST page 264

TYPE: EU_108

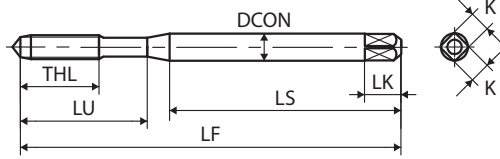

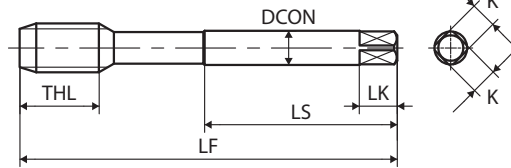

TYPE: EU_116



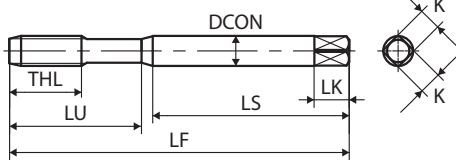

TYPE: EU_109



M	TCTR (tolerance)	 Hole Ø (mm)	Hole Ø (mm)	Code	THCHT (chamfer)	LF (mm)	THL (mm)	LU (mm)	LS (mm)	DCON (mm)	K (mm)	LK (mm)	NOF	Type	Stock
DIN 371															
M3X0.5	ISO2X(6HX)	2.5	2.56	96263.0TC	2.5P	56	9	18	34	3.5	2.7	6	3	108	▽
M4X0.7	ISO2X(6HX)	3.3	3.38	96264.0TC	2.5P	63	13	21	38	4.5	3.4	6	4	108	▽
M5X0.8	ISO2X(6HX)	4.2	4.28	96265.0TC	2.5P	70	14	25	39	6	4.9	8	4	108	▽
M6X1	ISO2X(6HX)	5	5.09	96266.0TC	2.5P	80	15	30	45	6	4.9	8	4	108	▽
M8X1.25	ISO2X(6HX)	6.8	6.85	96268.0TC	2.5P	90	19	35	47	8	6.2	9	4	109	▽
M10X1.5	ISO2X(6HX)	8.5	8.6	9626010TC	2.5P	100	23	39	52	10	8	11	4	109	▽

M	TCTR (tolerance)	 Hole Ø (mm)	Hole Ø (mm)	Code	THCHT (chamfer)	LF (mm)	THL (mm)	LU (mm)	LS (mm)	DCON (mm)	K (mm)	LK (mm)	NOF	Type	Stock
DIN 376															
M6X1	ISO2X(6HX)	5	5.09	97266.0TC	2.5P	80	15	-	-	4.5	3.4	6	4	116	▽
M8X1.25	ISO2X(6HX)	6.8	6.85	97268.0TC	2.5P	90	19	-	46	6	4.9	8	4	116	▽
M10X1.5	ISO2X(6HX)	8.5	8.6	9726010TC	2.5P	100	23	-	51	7	5.5	8	4	116	▽
M12X1.75	ISO2X(6HX)	10.3	10.36	9726012TC	2.5P	110	26	-	56	9	7	10	4	116	▽
M14X2	ISO2X(6HX)	12	12.12	9726014TC	2.5P	110	26	-	56	11	9	12	4	116	▽
M16X2	ISO2X(6HX)	14	14.12	9726016TC	2.5P	110	26	-	56	12	9	12	4	116	▽
M18X2.5	ISO2X(6HX)	15.5	15.63	9726018TC	2.5P	125	33	-	64	14	11	14	4	116	▽
M20X2.5	ISO2X(6HX)	17.5	17.63	9726020TC	2.5P	140	33	-	71	16	12	15	4	116	▽
M22X2.5	ISO2X(6HX)	19.5	19.63	9726022TC	2.5P	140	33	-	71	18	14.5	17	4	116	▽
M24X3	ISO2X(6HX)	21	21.13	9726024TC	2.5P	160	37	-	82	18	14.5	17	4	116	▽

MF	TCTR (tolerance)	 Hole Ø (mm)	Hole Ø (mm)	Code	THCHT (chamfer)	LF (mm)	THL (mm)	LU (mm)	LS (mm)	DCON (mm)	K (mm)	LK (mm)	NOF	Type	Stock
DIN 374															
M8X1	ISO2X(6HX)	7	7.09	98268.0MTC	2.5P	90	19	-	46	6	4.9	8	4	116	▽
M10X1.25	ISO2X(6HX)	8.8	8.85	9826010NTC	2.5P	100	23	-	51	7	5.5	8	4	116	▽
M10X1	ISO2X(6HX)	9	9.09	9826010MTC	2.5P	90	19	-	46	7	5.5	8	4	116	▽
M12X1.5	ISO2X(6HX)	10.5	10.6	98260120TC	2.5P	100	21	-	51	9	7	10	4	116	▽
M12X1.25	ISO2X(6HX)	10.8	10.85	9826012MTC	2.5P	100	21	-	51	9	7	10	4	116	▽
M12X1	ISO2X(6HX)	11	11.09	9826012MTC	2.5P	100	21	-	51	9	7	10	4	116	▽
M14X1.5	ISO2X(6HX)	12.5	12.6	98260140TC	2.5P	100	21	-	51	11	9	12	4	116	▽
M16X1.5	ISO2X(6HX)	14.5	14.6	98260160TC	2.5P	100	21	-	51	12	9	12	4	116	▽
M18X1.5	ISO2X(6HX)	16.5	16.6	98260180TC	2.5P	110	24	-	56	14	11	14	4	116	▽
M20X1.5	ISO2X(6HX)	18.5	18.6	98260200TC	2.5P	125	24	-	64	16	12	15	4	116	▽
M22X1.5	ISO2X(6HX)	20.5	20.6	98260220TC	2.5P	125	24	-	64	18	14.5	17	4	116	▽
M24X1.5	ISO2X(6HX)	22.5	22.6	98260240TC	2.5P	140	27	-	71	18	14.5	17	4	116	▽

G(BSP)	TCTR (tolerance)	 Hole Ø (mm)	Hole Ø (mm)	Code	THCHT (chamfer)	Basic major Ø (mm)	LF (mm)	THL (mm)	LS (mm)	DCON (mm)	K (mm)	LK (mm)	NOF	Type	Stock
DIN 5156															
1/8-28	-	8.75	8.78	9926R02TC	2.5P	9.728	90	19	46	7	5.5	8	4	116	▽
1/4-19	-	11.75	11.78	9926R04TC	2.5P	13.157	100	21	51	11	9	12	4	116	▽
3/8-19	-	15.25	15.28	9926R06TC	2.5P	16.662	100	21	51	12	9	12	4	116	▽
1/2-14	-	19	19.04	9926R08TC	2.5P	20.955	125	24	64	16	12	15	4	116	▽

Intro
SP
SL
PO
ST
DIN
ROLL
CARBIDE
LONG
HAND TAPS
EG (STI)
SPECIAL THREADS, GAUGES
THREAD MILLS
DIES
CENTER DRILLS
Technical info

Intro

GG-HT-OH TiCN



MS Material Specific Series

SP

Straight Fluted Taps for Cast Iron with Axial Coolant Hole, Coated

SL



PO

Recommended Tapping Speeds Depending On Materials

ISO	Vc (m/min)		ISO	Vc (m/min)	
K1	10÷30	★	N2	10÷30	☆
K2	10÷30	★	N4	10÷30	★
K3	≤15	★			
K4	≤10	☆			

ST

DIN

★ 1st choice ☆ suitable

ROLL

CARBIDE

LONG

HAND TAPS

EG (STI)

SPECIAL THREADS, GAUGES

THREAD MILLS

DIES

CENTER DRILLS

Technical info

FEATURES

Material specific with axial oil hole for blind hole application.

Specific design for best performance on cast iron application.

Special coating allows stable and long life even at high speed.

This item will be gradually replaced by:

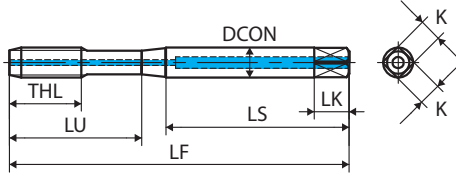

· GGST-CH page 266

TYPE: EU_110

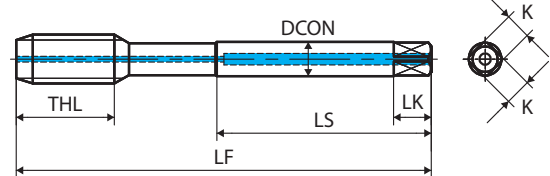

TYPE: EU_114



M	TCTR (tolerance)	 Hole Ø (mm)	Hole Ø (mm)	Code	THCHT (chamfer)	LF (mm)	THL (mm)	LU (mm)	LS (mm)	DCON (mm)	K (mm)	LK (mm)	NOF	Type	Stock
DIN 371															
M6X1	ISO2X(6HX)	5	5.09	96266.0TCOH	2.5P	80	15	30	45	6	4.9	8	4	110	▽
M8X1.25	ISO2X(6HX)	6.8	6.85	96268.0TCOH	2.5P	90	19	35	47	8	6.2	9	4	110	▽
M10X1.5	ISO2X(6HX)	8.5	8.6	9626010TCOH	2.5P	100	23	39	52	10	8	11	4	110	▽
M	TCTR (tolerance)	 Hole Ø (mm)	Hole Ø (mm)	Code	THCHT (chamfer)	LF (mm)	THL (mm)	LU (mm)	LS (mm)	DCON (mm)	K (mm)	LK (mm)	NOF	Type	Stock
DIN 376															
M12X1.75	ISO2X(6HX)	10.3	10.36	9726012TCOH	2.5P	110	26	-	56	9	7	10	4	114	▽
M14X2	ISO2X(6HX)	12	12.12	9726014TCOH	2.5P	110	26	-	56	11	9	12	4	114	▽
M16X2	ISO2X(6HX)	14	14.12	9726016TCOH	2.5P	110	26	-	56	12	9	12	4	114	▽
M18X2.5	ISO2X(6HX)	15.5	15.63	9726018TCOH	2.5P	125	33	-	64	14	11	14	4	114	▽
M20X2.5	ISO2X(6HX)	17.5	17.63	9726020TCOH	2.5P	140	33	-	71	16	12	15	4	114	▽
MF	TCTR (tolerance)	 Hole Ø (mm)	Hole Ø (mm)	Code	THCHT (chamfer)	LF (mm)	THL (mm)	LU (mm)	LS (mm)	DCON (mm)	K (mm)	LK (mm)	NOF	Type	Stock
DIN 374															
M8X1	ISO2X(6HX)	7	7.09	98268.0MTCOH	2.5P	90	19	-	46	6	4.9	8	4	114	▽
M10X1.25	ISO2X(6HX)	8.8	8.85	9826010NTCOH	2.5P	100	23	-	51	7	5.5	8	4	114	▽
M10X1	ISO2X(6HX)	9	9.09	9826010MTCOH	2.5P	90	19	-	46	7	5.5	8	4	114	▽
M12X1.5	ISO2X(6HX)	10.5	10.6	98260120TCOH	2.5P	100	21	-	51	9	7	10	4	114	▽
M12X1.25	ISO2X(6HX)	10.8	10.85	9826012NTCOH	2.5P	100	21	-	51	9	7	10	4	114	▽
M14X1.5	ISO2X(6HX)	12.5	12.6	98260140TCOH	2.5P	100	21	-	51	11	9	12	4	114	▽
M16X1.5	ISO2X(6HX)	14.5	14.6	98260160TCOH	2.5P	100	21	-	51	12	9	12	4	114	▽
M18X1.5	ISO2X(6HX)	16.5	16.6	98260180TCOH	2.5P	110	24	-	56	14	11	14	4	114	▽
M20X1.5	ISO2X(6HX)	18.5	18.6	98260200TCOH	2.5P	125	24	-	64	16	12	15	4	114	▽

Intro

SP

SL

PO

ST

DIN

ROLL

CARBIDE

LONG

HAND
TAPS

EG (STI)

SPECIAL
THREADS,
GAUGESTHREAD
MILLS

DIES

CENTER
DRILLSTechnical
info

Intro

LA-HT

MS Material Specific Series

Straight Fluted Taps for Die Cast Materials



SP

SL



PO

Recommended Tapping Speeds Depending On Materials

ISO	Vc (m/min)
N1	5÷15 ★
N2	5÷15 ★
N3	5÷10 ★
N4	5÷10 ★

ST

DIN

★ 1st choice ☆ suitable

ROLL

CARBIDE

LONG

HAND TAPS

EG (STI)

SPECIAL THREADS, GAUGES

THREAD MILLS

DIES



CENTER DRILLS

Technical info

FEATURES

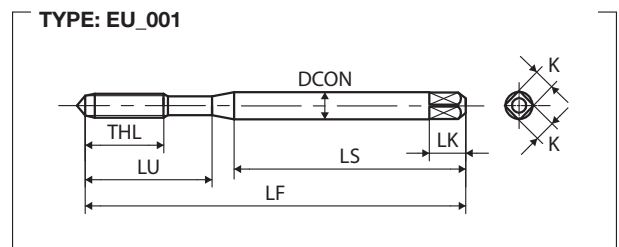
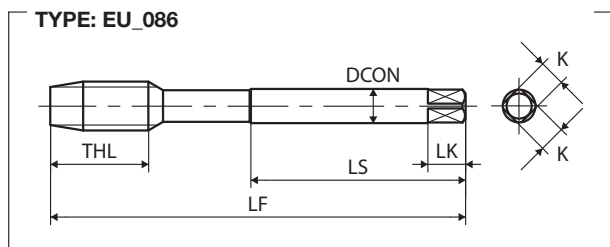
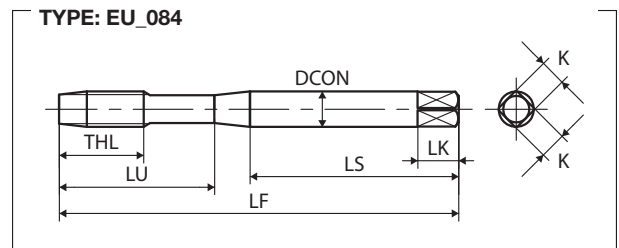
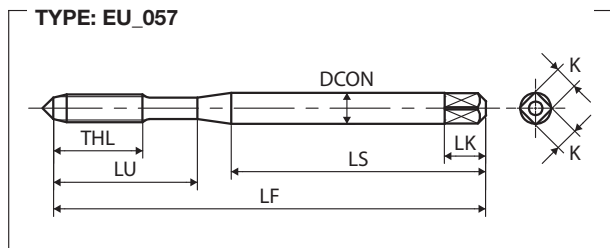
Material specific for through hole application.
Specific design and NI treatment allow stable and long life on Aluminium, Aluminium casting and die-casting.



M	TCTR (tolerance)	 Hole Ø (mm)	Hole Ø (mm)	Code	THCHT (chamfer)	LF (mm)	THL (mm)	LU (mm)	LS (mm)	DCON (mm)	K (mm)	LK (mm)	NOF	Type	Stock
DIN 371															
M2X0.4	ISO2X(6HX)	1.6	1.65	TD2.0EBLEN5	5P	45	8	-	32	2.8	2.1	5	3	001	○
M2.5X0.45	ISO2X(6HX)	2.1	2.11	TD2.5FBLEN5	5P	50	8	15	33	2.8	2.1	5	3	057	○
M3X0.5	ISO2X(6HX)	2.5	2.56	TD3.0GBLEN5	5P	56	9	18	34	3.5	2.7	6	3	057	●
M4X0.7	ISO2X(6HX)	3.3	3.38	TD4.0IBLEN5	5P	63	13	21	38	4.5	3.4	6	3	057	●
M5X0.8	ISO2X(6HX)	4.2	4.28	TD5.0KBLEN5	5P	70	14	25	39	6	4.9	8	3	057	●
M6X1	ISO2X(6HX)	5	5.09	TD6.0MBLEN5	5P	80	15	30	45	6	4.9	8	3	057	●
M8X1.25	ISO2X(6HX)	6.8	6.85	TD8.0NBLEN5	5P	90	19	35	47	8	6.2	9	3	084	●
M10X1.5	ISO2X(6HX)	8.5	8.6	TD0100BLEN5	5P	100	23	39	52	10	8	11	4	084	●
M	TCTR (tolerance)	 Hole Ø (mm)	Hole Ø (mm)	Code	THCHT (chamfer)	LF (mm)	THL (mm)	LU (mm)	LS (mm)	DCON (mm)	K (mm)	LK (mm)	NOF	Type	Stock
DIN 376															
M12X1.75	ISO2X(6HX)	10.3	10.36	TG012PBLEN5	5P	110	26	-	56	9	7	10	4	086	●
M14X2	ISO2X(6HX)	12	12.12	TG014QBLEN5	5P	110	26	-	56	11	9	12	4	086	○
M16X2	ISO2X(6HX)	14	14.12	TG016QBLEN5	5P	110	26	-	56	12	9	12	4	086	○

Intro

SP

SL

PO

ST

DIN

ROLL

CARBIDE

LONG

HAND
TAPS

EG (STI)

SPECIAL
THREADS,
GAUGESTHREAD
MILLS

DIES

CENTER
DRILLSTechnical
info

Intro

AXE-HT



MS Material Specific Series

AXE Straight Fluted Taps for Die Cast Aluminium Alloys, Coated

SP

SL



PO

Recommended Tapping Speeds Depending On Materials

ISO	Vc (m/min)	ISO	Vc (m/min)
K1	10÷20 ☆	N1	10÷20 ☆
		N2	10÷20 ★
		N4	10÷20 ★

★ 1st choice ☆ suitable

ST

DIN

ROLL

CARBIDE

Product Features

Comparison of tool life between AXE and competitor
M8x1.25

AXE	HSS-P Special coating
Work-material	G-ALMg5
Thread length	13mm (blind hole)
Tapping speed	10m/min
Bored hole	ø6.8
Feed	Lead screw feed
Machine	Transfer machine
Lubricant	Water soluble oil (x30)

LONG

HAND TAPS

EG (STI)

SPECIAL THREADS, GAUGES

THREAD MILLS

DIES

CENTER DRILLS

Technical info

FEATURES

Material specific for blind hole application. 1.5P extra short chamfer length.

Specific cutting edge design to minimize chipping trouble on Aluminium die-casting application.

HSSP and suitable coating for extraordinary long life.

Wear condition after 7000 threads

AXE

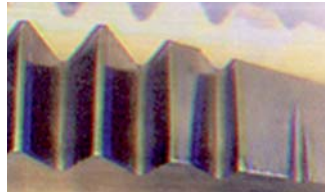

Competitor

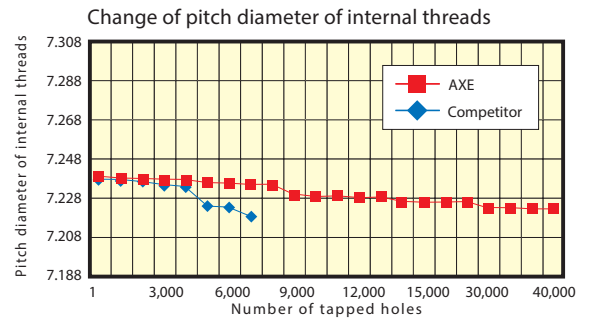
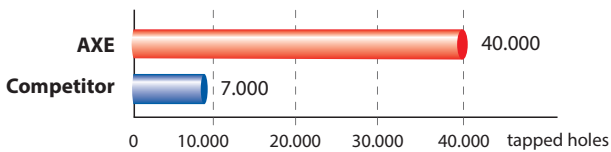
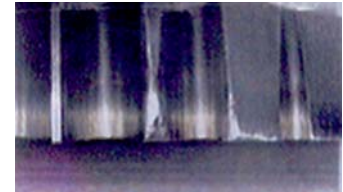

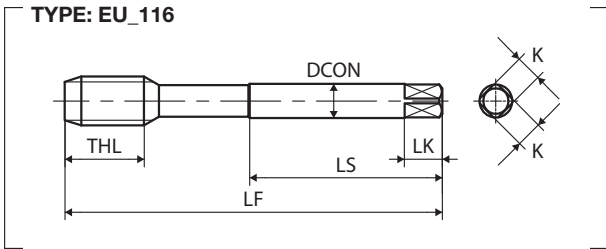
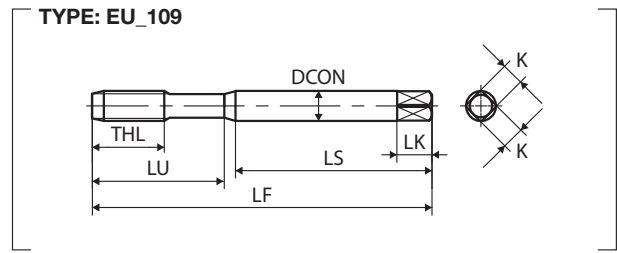
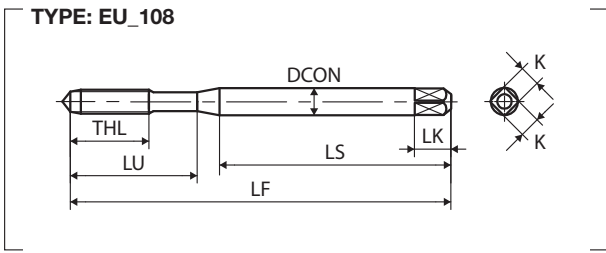

M	TCTR (tolerance)	\varnothing (mm)	Hole \varnothing (mm)	Code	THCHT (chamfer)	LF (mm)	THL (mm)	LU (mm)	LS (mm)	DCON (mm)	K (mm)	LK (mm)	NOF	Type	Stock
DIN 371															
M6X1	IS02X(6HX)	5	5.09	TD6.0MBLPVA	1.5P	80	15	30	45	6	4.9	8	3	108	●
M8X1.25	IS02X(6HX)	6.8	6.85	TD8.0NBLPVA	1.5P	90	19	35	47	8	6.2	9	4	109	●
M10X1.5	IS02X(6HX)	8.5	8.6	TD0100BLPVA	1.5P	100	23	39	52	10	8	11	4	109	●
M	TCTR (tolerance)	\varnothing (mm)	Hole \varnothing (mm)	Code	THCHT (chamfer)	LF (mm)	THL (mm)	LU (mm)	LS (mm)	DCON (mm)	K (mm)	LK (mm)	NOF	Type	Stock
DIN 376															
M12X1.75	IS02X(6HX)	10.3	10.36	TG012PBLPVA	1.5P	110	26	-	56	9	7	10	4	116	●
MF	TCTR (tolerance)	\varnothing (mm)	Hole \varnothing (mm)	Code	THCHT (chamfer)	LF (mm)	THL (mm)	LU (mm)	LS (mm)	DCON (mm)	K (mm)	LK (mm)	NOF	Type	Stock
DIN 374															
M10X1.25	IS02X(6HX)	8.8	8.85	TM010NBLPVA	1.5P	100	23	-	51	7	5.5	8	4	116	●
M10X1	IS02X(6HX)	9	9.09	TM010MBLPVA	1.5P	90	19	-	46	7	5.5	8	4	116	○
M12X1.5	IS02X(6HX)	10.5	10.6	TM0120BLPVA	1.5P	100	21	-	51	9	7	10	4	116	○
M12X1.25	IS02X(6HX)	10.8	10.85	TM012NBLPVA	1.5P	100	21	-	51	9	7	10	4	116	●

Intro

SP

SL

PO

ST

DIN

ROLL

CARBIDE

LONG

HAND
TAPS

EG (STI)

SPECIAL
THREADS,
GAUGES

THREAD
MILLS

DIES

CENTER
DRILLS

Technical
info

Straight Fluted Taps

Intro

HT

GP General Purpose Series

Straight Fluted Taps



SP

SL



PO

Recommended Tapping Speeds Depending On Materials

ISO	Vc (m/min)	ISO	Vc (m/min)	ISO	Vc (m/min)
P1	5÷10 ☆	K1	5÷10 ☆	N2	5÷10 ☆
P2	5÷10 ★	K2	5÷10 ☆	N3	5÷10 ☆
P3	5÷10 ☆	K3	5÷10 ☆	N4	5÷10 ☆
P4	5÷10 ☆				

★ 1st choice ☆ suitable

ST

JIS

ROLL

CARBIDE

LONG

HAND TAPS

EG (STI)

SPECIAL THREADS, GAUGES

THREAD MILLS

DIES

CENTER DRILLS

Technical info

FEATURES

General purpose for blind and through hole application.
For steel application at low cutting speed, also suitable for cast iron and non-ferrous materials.

TYPE: HT_005

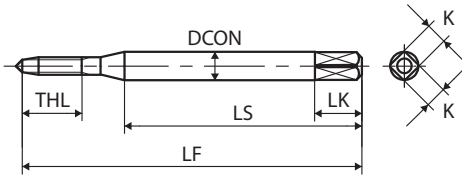

TYPE: HT_001

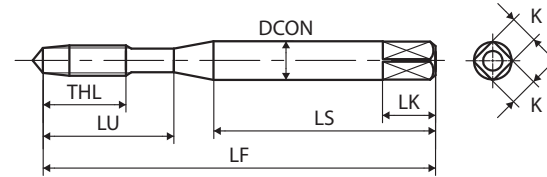

TYPE: HT_002

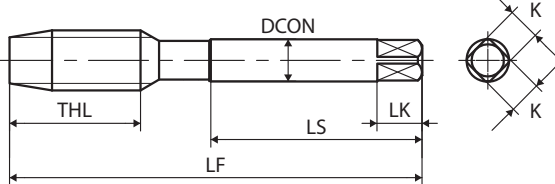

TYPE: HT_037

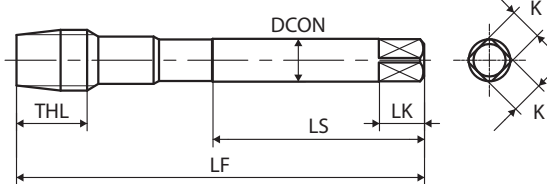

TYPE: HT_025

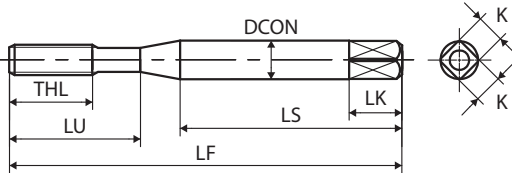

M	TCTR (tolerance)	∅ (mm)	Hole ∅ (mm)	Code	THCHT (chamfer)	LF (mm)	THL (mm)	LU (mm)	LS (mm)	DCON (mm)	K (mm)	LK (mm)	NOF	Type	Stock	Intro
JIS																
M1X0.25	P1	0.75	0.77	TNMP1.0B5	5P	36	4.5	-	24	3	2.5	5	3	005	○	
	P1	0.75	0.77	TNMP1.0B1	1.5P	36	4.5	-	24	3	2.5	5	3	005	●	SP
M1.1X0.25	P1	0.85	0.87	TNMP1.1B5	5P	36	4.5	-	24	3	2.5	5	3	005	○	
	P1	0.85	0.87	TNMP1.1B1	1.5P	36	4.5	-	24	3	2.5	5	3	005	●	
M1.2X0.25	P1	0.95	0.97	TNMP1.2B5	5P	36	4.5	-	24	3	2.5	5	3	005	○	
	P1	0.95	0.97	TNMP1.2B1	1.5P	36	4.5	-	24	3	2.5	5	3	005	●	SL
	P3(P1+30)	0.95	0.97	TNMR1.2B5	5P	36	4.5	-	24	3	2.5	5	3	005	○	
	P3(P1+30)	0.95	0.97	TNMR1.2B1	1.5P	36	4.5	-	24	3	2.5	5	3	005	○	
M1.4X0.3	P1	1.1	1.13	TNMP1.4C5	5P	36	5.4	-	24	3	2.5	5	3	005	●	
	P1	1.1	1.13	TNMP1.4C1	1.5P	36	5.4	-	24	3	2.5	5	3	005	○	PO
	P3(P1+30)	1.1	1.13	TNMR1.4C5	5P	36	5.4	-	24	3	2.5	5	3	005	○	
	P3(P1+30)	1.1	1.13	TNMR1.4C1	1.5P	36	5.4	-	24	3	2.5	5	3	005	○	
M1.6X0.35	P2	1.25	1.3	TNMQ1.6D5	5P	36	6.3	-	24	3	2.5	5	3	005	○	
	P2	1.25	1.3	TNMQ1.6D1	1.5P	36	6.3	-	24	3	2.5	5	3	005	●	ST JIS
M1.7X0.35	P1	1.35	1.4	TNMP1.7D5	5P	36	6.3	-	24	3	2.5	5	3	005	○	
	P1	1.35	1.4	TNMP1.7D1	1.5P	36	6.3	-	24	3	2.5	5	3	005	●	
	P3(P1+30)	1.35	1.4	TNMR1.7D5	5P	36	6.3	-	24	3	2.5	5	3	005	○	ROLL
	P3(P1+30)	1.35	1.4	TNMR1.7D1	1.5P	36	6.3	-	24	3	2.5	5	3	005	○	
M1.8X0.35	P2	1.45	1.5	TNMQ1.8D5	5P	42	6.3	-	27	3	2.5	5	3	005	○	
	P2	1.45	1.5	TNMQ1.8D1	1.5P	42	6.3	-	27	3	2.5	5	3	005	●	CARBIDE
M2X0.4	P1	1.6	1.65	TNMP2.0E5	5P	42	7.2	12	27	3	2.5	5	3	001	○	
	P1	1.6	1.65	TNMP2.0E1	1.5P	42	7.2	12	27	3	2.5	5	3	001	●	
	P3(P1+30)	1.6	1.65	TNMR2.0E5	5P	42	7.2	12	27	3	2.5	5	3	001	○	
	P3(P1+30)	1.6	1.65	TNMR2.0E1	1.5P	42	7.2	12	27	3	2.5	5	3	001	○	LONG
	P4(P1+45)	1.6	1.65	TNMS2.0E5	5P	42	7.2	12	27	3	2.5	5	3	001	○	
	P4(P1+45)	1.6	1.65	TNMS2.0E1	1.5P	42	7.2	12	27	3	2.5	5	3	001	○	
M2.2X0.45	P2	1.75	1.81	TNMQ2.2F5	5P	42	8.1	12	27	3	2.5	5	3	001	○	
	P2	1.75	1.81	TNMQ2.2F1	1.5P	42	8.1	12	27	3	2.5	5	3	001	●	HAND TAPS
M2.3X0.4	P1	1.9	1.95	TNMP2.3E5	5P	42	7.2	12	27	3	2.5	5	3	001	○	
	P1	1.9	1.95	TNMP2.3E1	1.5P	42	7.2	12	27	3	2.5	5	3	001	●	
	P3(P1+30)	1.9	1.95	TNMR2.3E5	5P	42	7.2	12	27	3	2.5	5	3	001	○	
	P3(P1+30)	1.9	1.95	TNMR2.3E1	1.5P	42	7.2	12	27	3	2.5	5	3	001	○	EG (STI)
	P4(P1+45)	1.9	1.95	TNMS2.3E5	5P	42	7.2	12	27	3	2.5	5	3	001	○	
	P4(P1+45)	1.9	1.95	TNMS2.3E1	1.5P	42	7.2	12	27	3	2.5	5	3	001	○	SPECIAL THREADS, GAUGES
M2.5X0.45	P2	2.1	2.11	TNMQ2.5F5	5P	46	8.1	14	29	3	2.5	5	3	001	○	
	P2	2.1	2.11	TNMQ2.5F1	1.5P	46	8.1	14	29	3	2.5	5	3	001	●	
	P3(P2+15)	2.1	2.11	TNMR2.5F5	5P	46	8.1	14	29	3	2.5	5	3	001	○	
	P3(P2+15)	2.1	2.11	TNMR2.5F1	1.5P	46	8.1	14	29	3	2.5	5	3	001	○	THREAD MILLS
	P4(P2+30)	2.1	2.11	TNMS2.5F5	5P	46	8.1	14	29	3	2.5	5	3	001	○	
	P4(P2+30)	2.1	2.11	TNMS2.5F1	1.5P	46	8.1	14	29	3	2.5	5	3	001	○	
M2.6X0.45	P1	2.2	2.21	TNMP2.6F5	5P	46	8.1	14	29	3	2.5	5	3	001	○	
	P1	2.2	2.21	TNMP2.6F1	1.5P	46	8.1	14	29	3	2.5	5	3	001	●	DIES
	P3(P1+30)	2.2	2.21	TNMR2.6F5	5P	46	8.1	14	29	3	2.5	5	3	001	○	
	P3(P1+30)	2.2	2.21	TNMR2.6F1	1.5P	46	8.1	14	29	3	2.5	5	3	001	○	
	P4(P1+45)	2.2	2.21	TNMS2.6F5	5P	46	8.1	14	29	3	2.5	5	3	001	○	
	P4(P1+45)	2.2	2.21	TNMS2.6F1	1.5P	46	8.1	14	29	3	2.5	5	3	001	○	CENTER DRILLS
3M0.6	P2	2.45	2.47	TNMQ3.0H5	5P	46	9	14	26	4	3.2	6	3	001	○	
	P2	2.45	2.47	TNMQ3.0H1	1.5P	46	9	14	26	4	3.2	6	3	001	○	

Technical
info

Straight Fluted Taps

Intro	M	TCTR (tolerance)	\varnothing (mm)	Hole \varnothing (mm)	Code	THCHT (chamfer)	LF (mm)	THL (mm)	LU (mm)	LS (mm)	DCON (mm)	K (mm)	LK (mm)	NOF	Type	Stock
	JIS															
SP	M3X0.5	P2	2.5	2.56	TNMQ3.0G5	5P	46	9	14	26	4	3.2	6	3	001	○
		P2	2.5	2.56	TNMQ3.0G1	1.5P	46	9	14	26	4	3.2	6	3	001	●
		P3(P2+15)	2.5	2.56	TNMR3.0G5	5P	46	9	14	26	4	3.2	6	3	001	○
		P3(P2+15)	2.5	2.56	TNMR3.0G1	1.5P	46	9	14	26	4	3.2	6	3	001	○
		P4(P2+30)	2.5	2.56	TNMS3.0G5	5P	46	9	14	26	4	3.2	6	3	001	○
		P4(P2+30)	2.5	2.56	TNMS3.0G1	1.5P	46	9	14	26	4	3.2	6	3	001	○
		P5(P2+45)	2.5	2.56	TNMT3.0G5	5P	46	9	14	26	4	3.2	6	3	001	○
		P5(P2+45)	2.5	2.56	TNMT3.0G1	1.5P	46	9	14	26	4	3.2	6	3	001	○
PO	M3.5X0.6	P2	2.9	2.97	TNMQ3.5H5	5P	52	11	16	29	5	4	7	3	001	○
		P2	2.9	2.97	TNMQ3.5H1	1.5P	52	11	16	29	5	4	7	3	001	●
		P3(P2+15)	2.9	2.97	TNMR3.5H5	5P	52	11	16	29	5	4	7	3	001	○
		P3(P2+15)	2.9	2.97	TNMR3.5H1	1.5P	52	11	16	29	5	4	7	3	001	○
		P4(P2+30)	2.9	2.97	TNMS3.5H5	5P	52	11	16	29	5	4	7	3	001	○
		P4(P2+30)	2.9	2.97	TNMS3.5H1	1.5P	52	11	16	29	5	4	7	3	001	○
ROLL	4M0.75	P2	3.3	3.33	TNMQ4.0J53	5P	52	11	17	29	5	4	7	3	001	○
		P2	3.3	3.33	TNMQ4.0J13	1.5P	52	11	17	29	5	4	7	3	001	○
		P2	3.3	3.33	TNMQ4.0J5	5P	52	11	17	29	5	4	7	4	001	○
		P2	3.3	3.33	TNMQ4.0J1	1.5P	52	11	17	29	5	4	7	4	001	○
CARBIDE	M4X0.7	P2	3.3	3.38	TNMQ4.0I5	5P	52	11	17	29	5	4	7	3	001	○
		P2	3.3	3.38	TNMQ4.0I1	1.5P	52	11	17	29	5	4	7	3	001	●
		P3(P2+20)	3.3	3.38	TNMR4.0I53	5P	52	11	17	29	5	4	7	3	001	○
		P3(P2+20)	3.3	3.38	TNMR4.0I13	1.5P	52	11	17	29	5	4	7	3	001	○
		P4(P2+40)	3.3	3.38	TNMS4.0I53	5P	52	11	17	29	5	4	7	3	001	○
		P4(P2+40)	3.3	3.38	TNMS4.0I13	1.5P	52	11	17	29	5	4	7	3	001	○
		P5(P2+60)	3.3	3.38	TNMT4.0I53	5P	52	11	17	29	5	4	7	3	001	○
		P5(P2+60)	3.3	3.38	TNMT4.0I13	1.5P	52	11	17	29	5	4	7	3	001	○
HAND TAPS	M4.5X0.75	P2	3.8	3.83	TNMQ4.5J5	5P	60	13	21	33	5.5	4.5	7	4	001	○
		P2	3.8	3.83	TNMQ4.5J1	1.5P	60	13	21	33	5.5	4.5	7	4	001	●
		P2	3.8	3.83	TNMQ4.5J53	5P	60	13	21	33	5.5	4.5	7	3	001	○
		P2	3.8	3.83	TNMQ4.5J13	1.5P	60	13	21	33	5.5	4.5	7	3	001	○
SPECIAL THREADS, GAUGES	5M0.9	P2	4.15	4.19	TNMQ5.0L53	5P	60	13	22	33	5.5	4.5	7	3	001	○
		P2	4.15	4.19	TNMQ5.0L13	1.5P	60	13	22	33	5.5	4.5	7	3	001	○
		P2	4.15	4.19	TNMQ5.0L5	5P	60	13	22	33	5.5	4.5	7	4	001	○
		P2	4.15	4.19	TNMQ5.0L1	1.5P	60	13	22	33	5.5	4.5	7	4	001	○
THREAD MILLS	M5X0.8	P3	4.2	4.28	TNMR5.0K5	5P	60	13	22	33	5.5	4.5	7	3	001	○
		P3	4.2	4.28	TNMR5.0K1	1.5P	60	13	22	33	5.5	4.5	7	3	001	●
		P4(P3+20)	4.2	4.28	TNMS5.0K53	5P	60	13	22	33	5.5	4.5	7	3	001	○
		P4(P3+20)	4.2	4.28	TNMS5.0K13	1.5P	60	13	22	33	5.5	4.5	7	3	001	○
DIES	M5X0.8	P4(P3+20)	4.2	4.28	TNMS5.0K5	5P	60	13	22	33	5.5	4.5	7	4	001	○
		P4(P3+20)	4.2	4.28	TNMS5.0K1	1.5P	60	13	22	33	5.5	4.5	7	4	001	○
		P5(P3+40)	4.2	4.28	TNMT5.0K53	5P	60	13	22	33	5.5	4.5	7	3	001	○
		P5(P3+40)	4.2	4.28	TNMT5.0K13	1.5P	60	13	22	33	5.5	4.5	7	3	001	○
CENTER DRILLS	M5X0.8	P5(P3+40)	4.2	4.28	TNMT5.0K5	5P	60	13	22	33	5.5	4.5	7	4	001	○
		P5(P3+40)	4.2	4.28	TNMT5.0K1	1.5P	60	13	22	33	5.5	4.5	7	4	001	○
		P3	4.2	4.28	TNMR5.0K1F	1.5P	60	13	22	33	5.5	4.5	7	3	025	○
		P4(P3+20)	4.2	4.28	TNMS5.0K13F	1.5P	60	13	22	33	5.5	4.5	7	3	025	○

Technical info

M	TCTR (tolerance)	∅ (mm)	Hole ∅ (mm)	Code	THCHT (chamfer)	LF (mm)	THL (mm)	LU (mm)	LS (mm)	DCON (mm)	K (mm)	LK (mm)	NOF	Type	Stock	Intro
JIS																
M5.5X0.9	P2	4.65	4.69	TNMQ5.5L5	5P	62	15	26	33	6	4.5	7	4	001	○	
	P2	4.65	4.69	TNMQ5.5L1	1.5P	62	15	26	33	6	4.5	7	4	001	●	SP
M6X1	P2	5	5.09	TNMQ6.0M5	5P	62	15	26	33	6	4.5	7	3	001	○	
	P2	5	5.09	TNMQ6.0M1	1.5P	62	15	26	33	6	4.5	7	3	001	●	
	P3(P2+20)	5	5.09	TNMR6.0M53	5P	62	15	26	33	6	4.5	7	3	001	○	SL
	P3(P2+20)	5	5.09	TNMR6.0M13	1.5P	62	15	26	33	6	4.5	7	3	001	○	
	P4(P2+40)	5	5.09	TNMS6.0M53	5P	62	19	28	33	6	4.5	7	3	001	○	
	P4(P2+40)	5	5.09	TNMS6.0M13	1.5P	62	19	28	33	6	4.5	7	3	001	○	
	P4(P2+40)	5	5.09	TNMS6.0M5	5P	62	15	26	33	6	4.5	7	4	001	○	PO
	P4(P2+40)	5	5.09	TNMS6.0M1	1.5P	62	15	26	33	6	4.5	7	4	001	○	
	P5(P2+60)	5	5.09	TNMT6.0M53	5P	62	15	26	33	6	4.5	7	3	001	○	
	P5(P2+60)	5	5.09	TNMT6.0M13	1.5P	62	15	26	33	6	4.5	7	3	001	○	
	P5(P2+60)	5	5.09	TNMT6.0M5	5P	62	15	26	33	6	4.5	7	4	001	○	ST
	P5(P2+60)	5	5.09	TNMT6.0M1	1.5P	62	15	26	33	6	4.5	7	4	001	○	JIS
	P2	5	5.09	TNMQ6.0M1F	1.5P	62	15	26	33	6	4.5	7	3	025	○	
	P3(P2+20)	5	5.09	TNMR6.0M13F	1.5P	62	15	26	33	6	4.5	7	3	025	○	ROLL
P4(P2+40)	5	5.09	TNMS6.0M13F	1.5P	62	15	26	33	6	4.5	7	3	025	○		
M7X1	P2	6	6.09	TNMQ7.0M5	5P	70	19	-	36	6.2	5	8	4	002	○	
	P2	6	6.09	TNMQ7.0M1	1.5P	70	19	-	36	6.2	5	8	4	002	●	
	P4(P2+40)	6	6.09	TNMS7.0M5	5P	70	19	-	36	6.2	5	8	4	002	○	CARBIDE
	P4(P2+40)	6	6.09	TNMS7.0M1	1.5P	70	19	-	36	6.2	5	8	4	002	○	
	P2	6	6.09	TNMQ7.0M5T	5P	70	19	-	36	6.2	5	8	3	002	○	
	P2	6	6.09	TNMQ7.0M1T	1.5P	70	19	-	36	6.2	5	8	3	002	○	LONG
	P3(P2+20)	6	6.09	TNMR7.0M5	5P	70	19	-	36	6.2	5	8	4	002	○	
P3(P2+20)	6	6.09	TNMR7.0M1	1.5P	70	19	-	36	6.2	5	8	4	002	○		
M8X1.25	P3	6.8	6.85	TNMR8.0N5	5P	70	19	-	36	6.2	5	8	3	002	○	
	P3	6.8	6.85	TNMR8.0N1	1.5P	70	19	-	36	6.2	5	8	3	002	●	HAND TAPS
	P3	6.8	6.85	TNMR8.0N5F	5P	70	19	-	36	6.2	5	8	4	002	○	
	P3	6.8	6.85	TNMR8.0N1F	1.5P	70	19	-	36	6.2	5	8	4	002	○	
	P4(P3+20)	6.8	6.85	TNMS8.0N5F	5P	70	19	-	36	6.2	5	8	4	002	○	
	P4(P3+20)	6.8	6.85	TNMS8.0N1F	1.5P	70	19	-	36	6.2	5	8	4	002	○	EG (STI)
	P5(P3+40)	6.8	6.85	TNMT8.0N5F	5P	70	19	-	36	6.2	5	8	4	002	○	
P5(P3+40)	6.8	6.85	TNMT8.0N1F	1.5P	70	19	-	36	6.2	5	8	4	002	○	SPECIAL THREADS, GAUGES	
M9X1.25	P3	7.8	7.85	TNMR9.0N5	5P	75	23	-	38	7	5.5	8	4	002	○	
	P3	7.8	7.85	TNMR9.0N1	1.5P	75	23	-	38	7	5.5	8	4	002	●	
M10X1.5	P3	8.5	8.6	TNMR01005T	5P	75	23	-	38	7	5.5	8	3	002	○	
	P3	8.5	8.6	TNMR01001T	1.5P	75	23	-	38	7	5.5	8	3	002	○	THREAD MILLS
	P3	8.5	8.6	TNMR01005	5P	75	23	-	38	7	5.5	8	4	002	○	
	P3	8.5	8.6	TNMR01001	1.5P	75	23	-	38	7	5.5	8	4	002	●	
	P4(P3+20)	8.5	8.6	TNMS01005	5P	75	23	-	38	7	5.5	8	4	002	○	
	P4(P3+20)	8.5	8.6	TNMS01001	1.5P	75	23	-	38	7	5.5	8	4	002	○	
	P5(P3+40)	8.5	8.6	TNMT01005	5P	75	23	-	38	7	5.5	8	4	002	○	DIES
P5(P3+40)	8.5	8.6	TNMT01001	1.5P	75	23	-	38	7	5.5	8	4	002	○		
M11X1.5	P4	9.5	9.6	TNMS01105	5P	82	26	-	42	8.5	6.5	9	4	002	○	
	P4	9.5	9.6	TNMS01101	1.5P	82	26	-	42	8.5	6.5	9	4	002	●	CENTER DRILLS

Technical info

Straight Fluted Taps

Intro

SP

SL

PO

ST

JIS

ROLL

CARBIDE

LONG

HAND TAPS

EG (STI)

SPECIAL THREADS, GAUGES



THREAD MILLS

DIES

CENTER DRILLS

Technical info

M	TCTR (tolerance)	\varnothing (mm)	Hole \varnothing (mm)	Code	THCHT (chamfer)	LF (mm)	THL (mm)	LU (mm)	LS (mm)	DCON (mm)	K (mm)	LK (mm)	NOF	Type	Stock
JIS															
M12X1.75	P3	10.3	10.36	TNMR012P5	5P	82	26	-	42	8.5	6.5	9	4	002	○
	P3	10.3	10.36	TNMR012P1	1.5P	82	26	-	42	8.5	6.5	9	4	002	●
	P4(P3+20)	10.3	10.36	TNMS012P5	5P	82	26	-	42	8.5	6.5	9	4	002	○
	P4(P3+20)	10.3	10.36	TNMS012P1	1.5P	82	26	-	42	8.5	6.5	9	4	002	○
	P3	10.3	10.36	TNMR012P5T	5P	82	26	-	42	8.5	6.5	9	3	002	○
	P3	10.3	10.36	TNMR012P1T	1.5P	82	26	-	42	8.5	6.5	9	3	002	○
	P5(P3+40)	10.3	10.36	TNMT012P5	5P	82	26	-	42	8.5	6.5	9	4	002	○
	P5(P3+40)	10.3	10.36	TNMT012P1	1.5P	82	26	-	42	8.5	6.5	9	4	002	○
M14X2	P3	12	12.12	TNMR014Q5	5P	88	26	-	45	10.5	8	11	4	002	○
	P3	12	12.12	TNMR014Q1	1.5P	88	26	-	45	10.5	8	11	4	002	●
	P4(P3+20)	12	12.12	TNMS014Q5	5P	88	26	-	45	10.5	8	11	4	002	○
	P4(P3+20)	12	12.12	TNMS014Q1	1.5P	88	26	-	45	10.5	8	11	4	002	○
	P5(P3+40)	12	12.12	TNMT014Q5	5P	88	26	-	45	10.5	8	11	4	002	○
	P5(P3+40)	12	12.12	TNMT014Q1	1.5P	88	26	-	45	10.5	8	11	4	002	○
M16X2	P3	14	14.12	TNMR016Q5	5P	95	26	-	48	12.5	10	13	4	002	○
	P3	14	14.12	TNMR016Q1	1.5P	95	26	-	48	12.5	10	13	4	002	●
	P4(P3+20)	14	14.12	TNMS016Q5	5P	95	26	-	48	12.5	10	13	4	002	○
	P4(P3+20)	14	14.12	TNMS016Q1	1.5P	95	26	-	48	12.5	10	13	4	002	○
	P5(P3+40)	14	14.12	TNMT016Q5	5P	95	26	-	48	12.5	10	13	4	002	○
	P5(P3+40)	14	14.12	TNMT016Q1	1.5P	95	26	-	48	12.5	10	13	4	002	○
M18X2.5	P4	15.5	15.63	TNMS018R5	5P	100	33	-	51	14	11	14	4	002	○
	P4	15.5	15.63	TNMS018R1	1.5P	100	33	-	51	14	11	14	4	002	○
	P5(P4+20)	15.5	15.63	TNMT018R5	5P	100	33	-	51	14	11	14	4	002	○
	P5(P4+20)	15.5	15.63	TNMT018R1	1.5P	100	33	-	51	14	11	14	4	002	○
M20X2.5	P4	17.5	17.63	TNMS020R5	5P	105	33	-	50	15	12	15	4	002	○
	P4	17.5	17.63	TNMS020R1	1.5P	105	33	-	50	15	12	15	4	002	○
	P5(P4+20)	17.5	17.63	TNMT020R5	5P	105	33	-	50	15	12	15	4	002	○
	P5(P4+20)	17.5	17.63	TNMT020R1	1.5P	105	33	-	50	15	12	15	4	002	○
M22X2.5	P4	19.5	19.63	TNMS022R5	5P	115	33	-	55	17	13	16	4	002	○
	P4	19.5	19.63	TNMS022R1	1.5P	115	33	-	55	17	13	16	4	002	○
	P5(P4+20)	19.5	19.63	TNMT022R5	5P	115	33	-	55	17	13	16	4	002	○
	P5(P4+20)	19.5	19.63	TNMT022R1	1.5P	115	33	-	55	17	13	16	4	002	○
M24X3	P4	21	21.13	TNMS024S5	5P	120	39	-	55	19	15	18	4	002	○
	P4	21	21.13	TNMS024S1	1.5P	120	39	-	55	19	15	18	4	002	○
	P5(P4+20)	21	21.13	TNMT024S5	5P	120	39	-	55	19	15	18	4	002	○
	P5(P4+20)	21	21.13	TNMT024S1	1.5P	120	39	-	55	19	15	18	4	002	○
M27X3	P4	24	24.13	TNMS027S5	5P	130	39	-	60	20	15	18	4	002	○
	P4	24	24.13	TNMS027S1	1.5P	130	39	-	60	20	15	18	4	002	○
M30X3.5	P4	26.5	26.63	TNMS030T5	5P	135	46	-	62	23	17	20	4	002	○
	P4	26.5	26.63	TNMS030T1	1.5P	135	46	-	62	23	17	20	4	002	○
M33X3.5	P4	29.5	29.63	TNMS033T5	5P	145	46	-	67	25	19	22	4	002	○
	P4	29.5	29.63	TNMS033T1	1.5P	145	46	-	67	25	19	22	4	002	○
M36X4	P5	32	32.12	TNMT036U5	5P	155	52	-	71	28	21	24	4	002	○
	P5	32	32.12	TNMT036U1	1.5P	155	52	-	71	28	21	24	4	002	○
M39X4	P5	35	35.12	TNMT039U5	5P	165	52	-	76	30	23	26	4	002	○
	P5	35	35.12	TNMT039U1	1.5P	165	52	-	76	30	23	26	4	002	○

M	TCTR (tolerance)	 Hole Ø (mm)	Hole Ø (mm)	Code	THCHT (chamfer)	LF (mm)	THL (mm)	LU (mm)	LS (mm)	DCON (mm)	K (mm)	LK (mm)	NOF	Type	Stock
JIS															
M42X4.5	P5	37.5	37.63	TNMT042V5	5P	175	59	-	81	32	26	30	4	002	○
	P5	37.5	37.63	TNMT042V1	1.5P	175	59	-	81	32	26	30	4	002	○
M45X4.5	P5	40.5	40.63	TNMT045V5	5P	180	59	-	83	35	26	30	4	002	○
	P5	40.5	40.63	TNMT045V1	1.5P	180	59	-	83	35	26	30	4	002	○
M48X5	P5	43	43.12	TNMT048W5	5P	185	65	-	85	38	29	32	4	002	○
	P5	43	43.12	TNMT048W1	1.5P	185	65	-	85	38	29	32	4	002	○
M52X5	II	47	47.1	TH2052W5	5P	195	90	-	105	42	32	35	4	002	○
	II	47	47.1	TH2052W1	1.5P	195	90	-	105	42	32	35	4	002	○
M56X5.5	II	50.5	50.6	TH2056X5	5P	205	95	-	110	44	35	38	4	002	○
	II	50.5	50.6	TH2056X1	1.5P	205	95	-	110	44	35	38	4	002	○
M60X5.5	II	54.5	54.6	TH2060X5	5P	215	100	-	115	46	35	38	4	002	○
	II	54.5	54.6	TH2060X1	1.5P	215	100	-	115	46	35	38	4	002	○
M64X6	II	58	58.1	TH2064Y5	5P	225	105	-	120	48	38	42	4	002	○
	II	58	58.1	TH2064Y1	1.5P	225	105	-	120	48	38	42	4	002	○
M68X6	II	62	62.1	TH2068Y5	5P	235	110	-	125	52	41	44	4	002	○
	II	62	62.1	TH2068Y1	1.5P	235	110	-	125	52	41	44	4	002	○
M70X6	II	64	64.1	TH2070Y5	5P	240	115	-	125	55	41	44	4	002	○
	II	64	64.1	TH2070Y1	1.5P	240	115	-	125	55	41	44	4	002	○
M72X6	II	66	66.1	TH2072Y5	5P	240	115	-	125	55	41	44	4	002	○
	II	66	66.1	TH2072Y1	1.5P	240	115	-	125	55	41	44	4	002	○
M76X6	II	70	70.1	TH2076Y5	5P	240	115	-	125	58	46	50	4	002	○
	II	70	70.1	TH2076Y1	1.5P	240	115	-	125	58	46	50	4	002	○
M80X6	II	74	74.1	TH2080Y5	5P	245	115	-	130	58	46	50	6	002	○
	II	74	74.1	TH2080Y1	1.5P	245	115	-	130	58	46	50	6	002	○
M85X6	II	79	79.1	TH2085Y5	5P	245	115	-	130	60	46	50	6	002	○
	II	79	79.1	TH2085Y1	1.5P	245	115	-	130	60	46	50	6	002	○
M90X6	II	84	84.1	TH2090Y5	5P	250	120	-	130	60	46	50	6	002	○
	II	84	84.1	TH2090Y1	1.5P	250	120	-	130	60	46	50	6	002	○
M95X6	II	89	89.1	TH2095Y5	5P	250	120	-	130	65	50	52	6	002	○
	II	89	89.1	TH2095Y1	1.5P	250	120	-	130	65	50	52	6	002	○
M100X6	II	94	94.1	TH2100Y5	5P	250	120	-	130	65	50	52	6	002	○
	II	94	94.1	TH2100Y1	1.5P	250	120	-	130	65	50	52	6	002	○
JIS															
MF	TCTR (tolerance)	 Hole Ø (mm)	Hole Ø (mm)	Code	THCHT (chamfer)	LF (mm)	THL (mm)	LU (mm)	LS (mm)	DCON (mm)	K (mm)	LK (mm)	NOF	Type	Stock
JIS															
M1X0.2	P1	0.8	0.81	TNMP1.0A5	5P	36	3.6	-	24	3	2.5	5	3	005	○
	P1	0.8	0.81	TNMP1.0A1	1.5P	36	3.6	-	24	3	2.5	5	3	005	○
M1.1X0.2	P1	0.9	0.91	TNMP1.1A5	5P	36	3.6	-	24	3	2.5	5	3	005	○
	P1	0.9	0.91	TNMP1.1A1	1.5P	36	3.6	-	24	3	2.5	5	3	005	○
M1.2X0.2	P1	1	1.01	TNMP1.2A5	5P	36	3.6	-	24	3	2.5	5	3	005	○
	P1	1	1.01	TNMP1.2A1	1.5P	36	3.6	-	24	3	2.5	5	3	005	○
M1.4X0.2	P1	1.2	1.21	TNMP1.4A5	5P	36	3.6	-	24	3	2.5	5	3	005	○
	P1	1.2	1.21	TNMP1.4A1	1.5P	36	3.6	-	24	3	2.5	5	3	005	○
M1.6X0.2	P1	1.4	1.41	TNMP1.6A5	5P	36	3.6	-	24	3	2.5	5	3	005	○
	P1	1.4	1.41	TNMP1.6A1	1.5P	36	3.6	-	24	3	2.5	5	3	005	○
M1.7X0.2	P1	1.5	1.51	TNMP1.7A5	5P	36	3.6	-	24	3	2.5	5	3	005	○
	P1	1.5	1.51	TNMP1.7A1	1.5P	36	3.6	-	24	3	2.5	5	3	005	○

Intro

SP

SL

PO

ST

JIS

ROLL

CARBIDE

LONG

HAND
TAPS

EG (STI)

SPECIAL
THREADS,
GAUGESTHREAD
MILLS

DIES

CENTER
DRILLSTechnical
info

Straight Fluted Taps

Intro

SP

SL

PO

ST

JIS

ROLL

CARBIDE

LONG

HAND TAPS

EG (STI)

SPECIAL THREADS, GAUGES

THREAD MILLS

DIES

CENTER DRILLS

Technical info

MF	TCTR (tolerance)	\varnothing (mm)	Hole \varnothing (mm)	Code	THCHT (chamfer)	LF (mm)	THL (mm)	LU (mm)	LS (mm)	DCON (mm)	K (mm)	LK (mm)	NOF	Type	Stock
JIS															
M1.8X0.2	P1	1.6	1.61	TNMP1.8A5	5P	42	3.6	-	27	3	2.5	5	3	005	○
	P1	1.6	1.61	TNMP1.8A1	1.5P	42	3.6	-	27	3	2.5	5	3	005	○
M2X0.25	P1	1.75	1.77	TNMP2.0B5	5P	42	4.5	12	27	3	2.5	5	3	001	○
	P1	1.75	1.77	TNMP2.0B1	1.5P	42	4.5	12	27	3	2.5	5	3	001	○
M2.2X0.25	P1	1.95	1.97	TNMP2.2B5	5P	42	4.5	12	27	3	2.5	5	3	001	○
	P1	1.95	1.97	TNMP2.2B1	1.5P	42	4.5	12	27	3	2.5	5	3	001	○
M2.3X0.25	P1	2.05	2.07	TNMP2.3B5	5P	42	4.5	12	27	3	2.5	5	3	001	○
	P1	2.05	2.07	TNMP2.3B1	1.5P	42	4.5	12	27	3	2.5	5	3	001	○
M2.5X0.35	P2	2.2	2.2	TNMQ2.5D5	5P	46	6.3	14	29	3	2.5	5	3	001	○
	P2	2.2	2.2	TNMQ2.5D1	1.5P	46	6.3	14	29	3	2.5	5	3	001	●
M2.6X0.35	P2	2.3	2.3	TNMQ2.6D5	5P	46	6.3	14	29	3	2.5	5	3	001	○
	P2	2.3	2.3	TNMQ2.6D1	1.5P	46	6.3	14	29	3	2.5	5	3	001	●
M3X0.35	P2	2.7	2.7	TNMQ3.0D5	5P	46	6.5	14	26	4	3.2	6	3	001	○
	P2	2.7	2.7	TNMQ3.0D1	1.5P	46	6.5	14	26	4	3.2	6	3	001	●
M3.5X0.35	P2	3.2	3.2	TNMQ3.5D5	5P	52	6.5	16	29	5	4	7	3	001	○
	P2	3.2	3.2	TNMQ3.5D1	1.5P	52	6.5	16	29	5	4	7	3	001	●
M4X0.5	P2	3.5	3.56	TNMQ4.0G5	5P	52	9	17	29	5	4	7	4	001	○
	P2	3.5	3.56	TNMQ4.0G1	1.5P	52	9	17	29	5	4	7	4	001	●
M4.5X0.5	P2	4	4.06	TNMQ4.5G5	5P	60	9	21	33	5.5	4.5	7	4	001	○
	P2	4	4.06	TNMQ4.5G1	1.5P	60	9	21	33	5.5	4.5	7	4	001	○
M5X0.75	P2	4.3	4.33	TNMQ5.0J5	5P	60	13	22	33	5.5	4.5	7	4	001	○
	P2	4.3	4.33	TNMQ5.0J1	1.5P	60	13	22	33	5.5	4.5	7	4	001	○
M5X0.5	P2	4.5	4.56	TNMQ5.0G5	5P	60	9	22	33	5.5	4.5	7	4	001	○
	P2	4.5	4.56	TNMQ5.0G1	1.5P	60	9	22	33	5.5	4.5	7	4	001	●
	P3(P2+15)	4.5	4.56	TNMR5.0G5	5P	60	9	22	33	5.5	4.5	7	4	001	○
	P3(P2+15)	4.5	4.56	TNMR5.0G1	1.5P	60	9	22	33	5.5	4.5	7	4	001	○
M5.5X0.75	P2	4.8	4.83	TNMQ5.5J5	5P	62	15	26	33	6	4.5	7	4	001	○
	P2	4.8	4.83	TNMQ5.5J1	1.5P	62	15	26	33	6	4.5	7	4	001	○
M5.5X0.5	P2	5	5.06	TNMQ5.5G5	5P	62	9	26	33	6	4.5	7	4	001	○
	P2	5	5.06	TNMQ5.5G1	1.5P	62	9	26	33	6	4.5	7	4	001	○
M6X0.75	P2	5.3	5.33	TNMQ6.0J5	5P	62	15	26	33	6	4.5	7	4	001	○
	P2	5.3	5.33	TNMQ6.0J1	1.5P	62	15	26	33	6	4.5	7	4	001	●
	P3(P2+20)	5.3	5.33	TNMR6.0J5	5P	62	15	26	33	6	4.5	7	4	001	○
	P3(P2+20)	5.3	5.33	TNMR6.0J1	1.5P	62	15	26	33	6	4.5	7	4	001	○
M6X0.5	P4(P2+40)	5.3	5.33	TNMS6.0J5	5P	62	15	26	33	6	4.5	7	4	001	○
	P4(P2+40)	5.3	5.33	TNMS6.0J1	1.5P	62	15	26	33	6	4.5	7	4	001	○
	P2	5.5	5.56	TNMQ6.0G5	5P	62	9	26	33	6	4.5	7	4	001	○
	P2	5.5	5.56	TNMQ6.0G1	1.5P	62	9	26	33	6	4.5	7	4	001	●
M6.5X0.5	P2	6	6.06	TNMQ6.5G5	5P	70	10	-	36	6.2	5	8	4	037	○
	P2	6	6.06	TNMQ6.5G1	1.5P	70	10	-	36	6.2	5	8	4	037	○
M7X0.75	P2	6.3	6.33	TNMQ7.0J5	5P	70	19	-	36	6.2	5	8	4	002	○
	P2	6.3	6.33	TNMQ7.0J1	1.5P	70	19	-	36	6.2	5	8	4	002	●
M7X0.5	P2	6.5	6.56	TNMQ7.0G5	5P	70	10	-	36	6.2	5	8	4	037	○
	P2	6.5	6.56	TNMQ7.0G1	1.5P	70	10	-	36	6.2	5	8	4	037	●
M7.5X0.5	P2	7	7.06	TNMQ7.5G5	5P	70	10	-	36	6.2	5	8	4	037	○
	P2	7	7.06	TNMQ7.5G1	1.5P	70	10	-	36	6.2	5	8	4	037	○

MF	TCTR (tolerance)	∅ (mm)	Hole ∅ (mm)	Code	THCHT (chamfer)	LF (mm)	THL (mm)	LU (mm)	LS (mm)	DCON (mm)	K (mm)	LK (mm)	NOF	Type	Stock	
JIS																Intro
M8X1	P2	7	7.09	TNMQ8.0M5	5P	70	19	-	36	6.2	5	8	4	002	○	
	P2	7	7.09	TNMQ8.0M1	1.5P	70	19	-	36	6.2	5	8	4	002	●	SP
	P4(P2+40)	7	7.09	TNMS8.0M5	5P	70	19	-	36	6.2	5	8	4	002	○	
	P4(P2+40)	7	7.09	TNMS8.0M1	1.5P	70	19	-	36	6.2	5	8	4	002	○	
	P2	7	7.09	TNMQ8.0M5T	5P	70	19	-	36	6.2	5	8	3	002	○	SL
	P2	7	7.09	TNMQ8.0M1T	1.5P	70	19	-	36	6.2	5	8	3	002	○	
	P3(P2+20)	7	7.09	TNMR8.0M5	5P	70	19	-	36	6.2	5	8	4	002	○	
P3(P2+20)	7	7.09	TNMR8.0M1	1.5P	70	19	-	36	6.2	5	8	4	002	○		
M8X0.75	P2	7.3	7.33	TNMQ8.0J5	5P	70	19	-	36	6.2	5	8	4	002	○	PO
	P2	7.3	7.33	TNMQ8.0J1	1.5P	70	19	-	36	6.2	5	8	4	002	●	
M8X0.5	P2	7.5	7.56	TNMQ8.0G5	5P	70	10	-	36	6.2	5	8	4	037	○	
	P2	7.5	7.56	TNMQ8.0G1	1.5P	70	10	-	36	6.2	5	8	4	037	●	ST
M8.5X1	P2	7.5	7.59	TNMQ8.5M5	5P	75	23	-	38	7	5.5	8	4	002	○	JIS
	P2	7.5	7.59	TNMQ8.5M1	1.5P	75	23	-	38	7	5.5	8	4	002	○	
M8.5X0.75	P2	7.8	7.81	TNMQ8.5J5	5P	75	13	-	38	7	5.5	8	4	037	○	ROLL
	P2	7.8	7.81	TNMQ8.5J1	1.5P	75	13	-	38	7	5.5	8	4	037	○	
M8.5X0.5	P2	8	8.06	TNMQ8.5G5	5P	75	11	-	38	7	5.5	8	4	037	○	
	P2	8	8.06	TNMQ8.5G1	1.5P	75	11	-	38	7	5.5	8	4	037	○	
M9X1	P2	8	8.09	TNMQ9.0M5	5P	75	23	-	38	7	5.5	8	4	002	○	CARBIDE
	P2	8	8.09	TNMQ9.0M1	1.5P	75	23	-	38	7	5.5	8	4	002	●	
M9X0.75	P2	8.3	8.33	TNMQ9.0J5	5P	75	13	-	38	7	5.5	8	4	037	○	
	P2	8.3	8.33	TNMQ9.0J1	1.5P	75	13	-	38	7	5.5	8	4	037	○	
M9X0.5	P2	8.5	8.56	TNMQ9.0G5	5P	75	11	-	38	7	5.5	8	4	037	○	LONG
	P2	8.5	8.56	TNMQ9.0G1	1.5P	75	11	-	38	7	5.5	8	4	037	○	
M9.5X1	P2	8.5	8.59	TNMQ9.5M5	5P	75	23	-	38	7	5.5	8	4	002	○	
	P2	8.5	8.59	TNMQ9.5M1	1.5P	75	23	-	38	7	5.5	8	4	002	○	
M9.5X0.75	P2	8.8	8.83	TNMQ9.5J5	5P	75	13	-	38	7	5.5	8	4	037	○	HAND TAPS
	P2	8.8	8.83	TNMQ9.5J1	1.5P	75	13	-	38	7	5.5	8	4	037	○	
M9.5X0.5	P2	9	9.06	TNMQ9.5G5	5P	75	11	-	38	7	5.5	8	4	037	○	
	P2	9	9.06	TNMQ9.5G1	1.5P	75	11	-	38	7	5.5	8	4	037	○	
M10X1.25	P3	8.8	8.85	TNMR010N5	5P	75	23	-	38	7	5.5	8	4	002	○	EG (STI)
	P3	8.8	8.85	TNMR010N1	1.5P	75	23	-	38	7	5.5	8	4	002	●	
	P4(P3+20)	8.8	8.85	TNMS010N5	5P	75	23	-	38	7	5.5	8	4	002	○	SPECIAL THREADS, GAUGES
	P4(P3+20)	8.8	8.85	TNMS010N1	1.5P	75	23	-	38	7	5.5	8	4	002	○	
	P3	8.8	8.85	TNMR010N5T	5P	75	23	-	38	7	5.5	8	3	002	○	
	P3	8.8	8.85	TNMR010N1T	1.5P	75	23	-	38	7	5.5	8	3	002	○	
	P5(P3+40)	8.8	8.85	TNMT010N5	5P	75	23	-	38	7	5.5	8	4	002	○	THREAD MILLS
P5(P3+40)	8.8	8.85	TNMT010N1	1.5P	75	23	-	38	7	5.5	8	4	002	○		
M10X1	P3	9	9.09	TNMR010M5	5P	75	23	-	38	7	5.5	8	4	002	○	
	P3	9	9.09	TNMR010M1	1.5P	75	23	-	38	7	5.5	8	4	002	●	
	P4(P3+20)	9	9.09	TNMS010M5	5P	75	23	-	38	7	5.5	8	4	002	○	DIES
	P4(P3+20)	9	9.09	TNMS010M1	1.5P	75	23	-	38	7	5.5	8	4	002	○	
M10X0.75	P3	9.3	9.33	TNMR010J5	5P	75	13	-	38	7	5.5	8	4	037	○	
	P3	9.3	9.33	TNMR010J1	1.5P	75	13	-	38	7	5.5	8	4	037	●	
M10X0.5	P2	9.5	9.56	TNMQ010G5	5P	75	11	-	38	7	5.5	8	4	037	○	CENTER DRILLS
	P2	9.5	9.56	TNMQ010G1	1.5P	75	11	-	38	7	5.5	8	4	037	●	

Technical info

Straight Fluted Taps

Intro

SP

SL

PO

ST

JIS

ROLL

CARBIDE

LONG

HAND TAPS

EG (STI)

SPECIAL THREADS, GAUGES

THREAD MILLS

DIES

CENTER DRILLS

Technical info

MF	TCTR (tolerance)	\varnothing (mm)	Hole \varnothing (mm)	Code	THCHT (chamfer)	LF (mm)	THL (mm)	LU (mm)	LS (mm)	DCON (mm)	K (mm)	LK (mm)	NOF	Type	Stock
JIS															
M11X1.25	P3	9.8	9.85	TNMR011N5	5P	82	26	-	42	8.5	6.5	9	4	002	○
	P3	9.8	9.85	TNMR011N1	1.5P	82	26	-	42	8.5	6.5	9	4	002	○
M11X1	P3	10	10.1	TNMR011M5	5P	82	26	-	42	8.5	6.5	9	4	002	○
	P3	10	10.1	TNMR011M1	1.5P	82	26	-	42	8.5	6.5	9	4	002	●
M11X0.75	P3	10.3	10.33	TNMR011J5	5P	82	14	-	42	8.5	6.5	9	4	037	○
	P3	10.3	10.33	TNMR011J1	1.5P	82	14	-	42	8.5	6.5	9	4	037	○
M11X0.5	P2	10.5	10.56	TNMQ011G5	5P	82	12	-	42	8.5	6.5	9	4	037	○
	P2	10.5	10.56	TNMQ011G1	1.5P	82	12	-	42	8.5	6.5	9	4	037	○
M12X1.5	P3	10.5	10.6	TNMR012O5	5P	82	26	-	42	8.5	6.5	9	4	002	○
	P3	10.5	10.6	TNMR012O1	1.5P	82	26	-	42	8.5	6.5	9	4	002	●
M12X1.5	P4(P3+20)	10.5	10.6	TNMS012O5	5P	82	26	-	42	8.5	6.5	9	4	002	○
	P4(P3+20)	10.5	10.6	TNMS012O1	1.5P	82	26	-	42	8.5	6.5	9	4	002	○
	P5(P3+40)	10.5	10.6	TNMT012O5	5P	82	26	-	42	8.5	6.5	9	4	002	○
	P5(P3+40)	10.5	10.6	TNMT012O1	1.5P	82	26	-	42	8.5	6.5	9	4	002	○
M12X1.25	P4	10.8	10.85	TNMS012N5	5P	82	26	-	42	8.5	6.5	9	4	002	○
	P4	10.8	10.85	TNMS012N1	1.5P	82	26	-	42	8.5	6.5	9	4	002	●
	P4	10.8	10.85	TNMS012N5T	5P	82	26	-	42	8.5	6.5	9	3	002	○
	P4	10.8	10.85	TNMS012N1T	1.5P	82	26	-	42	8.5	6.5	9	3	002	○
	P5(P4+20)	10.8	10.85	TNMT012N5	5P	82	26	-	42	8.5	6.5	9	4	002	○
M12X1	P3	11	11.09	TNMR012M5	5P	82	26	-	42	8.5	6.5	9	4	002	○
	P3	11	11.09	TNMR012M1	1.5P	82	26	-	42	8.5	6.5	9	4	002	●
M12X1	P4(P3+20)	11	11.09	TNMS012M5	5P	82	26	-	42	8.5	6.5	9	4	002	○
	P4(P3+20)	11	11.09	TNMS012M1	1.5P	82	26	-	42	8.5	6.5	9	4	002	○
M12X0.75	P3	11.3	11.33	TNMR012J5	5P	82	14	-	42	8.5	6.5	9	4	037	○
	P3	11.3	11.33	TNMR012J1	1.5P	82	14	-	42	8.5	6.5	9	4	037	○
M12X0.5	P2	11.5	11.56	TNMQ012G5	5P	82	12	-	42	8.5	6.5	9	4	037	○
	P2	11.5	11.56	TNMQ012G1	1.5P	82	12	-	42	8.5	6.5	9	4	037	○
M13X1.75	P3	11.3	11.4	TNMR013P5	5P	88	26	-	45	10.5	8	11	4	002	○
	P3	11.3	11.4	TNMR013P1	1.5P	88	26	-	45	10.5	8	11	4	002	○
M13X1.5	P3	11.6	11.6	TNMR013O5	5P	88	26	-	45	10.5	8	11	4	002	○
	P3	11.6	11.6	TNMR013O1	1.5P	88	26	-	45	10.5	8	11	4	002	●
M13X1.25	P4	11.8	11.85	TNMS013N5	5P	88	26	-	45	10.5	8	11	4	002	○
	P4	11.8	11.85	TNMS013N1	1.5P	88	26	-	45	10.5	8	11	4	002	○
M13X1	P3	12	12.09	TNMR013M5	5P	88	26	-	45	10.5	8	11	4	002	○
	P3	12	12.09	TNMR013M1	1.5P	88	26	-	45	10.5	8	11	4	002	●
M13X0.75	P3	12.3	12.33	TNMR013J5	5P	88	14	-	45	10.5	8	11	4	037	○
	P3	12.3	12.33	TNMR013J1	1.5P	88	14	-	45	10.5	8	11	4	037	○
M13X0.5	P2	12.5	12.56	TNMQ013G5	5P	88	12	-	45	10.5	8	11	4	037	○
	P2	12.5	12.56	TNMQ013G1	1.5P	88	12	-	45	10.5	8	11	4	037	○
M14X1.75	P3	12.3	12.4	TNMR014P5	5P	88	26	-	45	10.5	8	11	4	002	○
	P3	12.3	12.4	TNMR014P1	1.5P	88	26	-	45	10.5	8	11	4	002	○
M14X1.5	P3	12.5	12.6	TNMR014O5	5P	88	26	-	45	10.5	8	11	4	002	○
	P3	12.5	12.6	TNMR014O1	1.5P	88	26	-	45	10.5	8	11	4	002	●
	P4(P3+20)	12.5	12.6	TNMS014O5	5P	88	26	-	45	10.5	8	11	4	002	○
	P4(P3+20)	12.5	12.6	TNMS014O1	1.5P	88	26	-	45	10.5	8	11	4	002	○
	P5(P3+40)	12.5	12.6	TNMT014O5	5P	88	26	-	45	10.5	8	11	4	002	○
P5(P3+40)	12.5	12.6	TNMT014O1	1.5P	88	26	-	45	10.5	8	11	4	002	○	

MF	TCTR (tolerance)	∅ (mm)	Hole ∅ (mm)	Code	THCHT (chamfer)	LF (mm)	THL (mm)	LU (mm)	LS (mm)	DCON (mm)	K (mm)	LK (mm)	NOF	Type	Stock
JIS															
M14X1.25	P4	12.8	12.85	TNMS014N5	5P	88	26	-	45	10.5	8	11	4	002	○
	P4	12.8	12.85	TNMS014N1	1.5P	88	26	-	45	10.5	8	11	4	002	●
M14X1	P3	13	13.09	TNMR014M5	5P	88	26	-	45	10.5	8	11	4	002	○
	P3	13	13.09	TNMR014M1	1.5P	88	26	-	45	10.5	8	11	4	002	●
	P4(P3+20)	13	13.09	TNMS014M5	5P	88	26	-	45	10.5	8	11	4	002	○
	P4(P3+20)	13	13.09	TNMS014M1	1.5P	88	26	-	45	10.5	8	11	4	002	○
M14X0.75	P3	13.3	13.33	TNMR014J5	5P	88	15	-	45	10.5	8	11	4	037	○
	P3	13.3	13.33	TNMR014J1	1.5P	88	15	-	45	10.5	8	11	4	037	○
M14X0.5	P2	13.5	13.56	TNMQ014G5	5P	88	12	-	45	10.5	8	11	4	037	○
	P2	13.5	13.56	TNMQ014G1	1.5P	88	12	-	45	10.5	8	11	4	037	○
M15X2	P3	13	13.12	TNMR015Q5	5P	95	26	-	48	12.5	10	13	4	002	○
	P3	13	13.12	TNMR015Q1	1.5P	95	26	-	48	12.5	10	13	4	002	○
M15X1.5	P3	13.5	13.6	TNMR015O5	5P	95	26	-	48	12.5	10	13	4	002	○
	P3	13.5	13.6	TNMR015O1	1.5P	95	26	-	48	12.5	10	13	4	002	●
M15X1.25	P4	13.8	13.85	TNMS015N5	5P	95	26	-	48	12.5	10	13	4	002	○
	P4	13.8	13.85	TNMS015N1	1.5P	95	26	-	48	12.5	10	13	4	002	○
M15X1	P3	14	14.09	TNMR015M5	5P	95	26	-	48	12.5	10	13	4	002	○
	P3	14	14.09	TNMR015M1	1.5P	95	26	-	48	12.5	10	13	4	002	●
M15X0.75	P3	14.3	14.33	TNMR015J5	5P	95	15	-	48	12.5	10	13	4	037	○
	P3	14.3	14.33	TNMR015J1	1.5P	95	15	-	48	12.5	10	13	4	037	○
M15X0.5	P2	14.5	14.56	TNMQ015G5	5P	95	13	-	48	12.5	10	13	4	037	○
	P2	14.5	14.56	TNMQ015G1	1.5P	95	13	-	48	12.5	10	13	4	037	○
M16X1.5	P3	14.5	14.6	TNMR016O5	5P	95	26	-	48	12.5	10	13	4	002	○
	P3	14.5	14.6	TNMR016O1	1.5P	95	26	-	48	12.5	10	13	4	002	●
	P4(P3+20)	14.5	14.6	TNMS016O5	5P	95	26	-	48	12.5	10	13	4	002	○
	P4(P3+20)	14.5	14.6	TNMS016O1	1.5P	95	26	-	48	12.5	10	13	4	002	○
	P5(P3+40)	14.5	14.6	TNMT016O5	5P	95	26	-	48	12.5	10	13	4	002	○
M16X1.25	P4	14.8	14.85	TNMS016N5	5P	95	26	-	48	12.5	10	13	4	002	○
	P4	14.8	14.85	TNMS016N1	1.5P	95	26	-	48	12.5	10	13	4	002	●
M16X1	P3	15	15.09	TNMR016M5	5P	95	26	-	48	12.5	10	13	4	002	○
	P3	15	15.09	TNMR016M1	1.5P	95	26	-	48	12.5	10	13	4	002	●
	P4(P3+20)	15	15.09	TNMS016M5	5P	95	26	-	48	12.5	10	13	4	002	○
	P4(P3+20)	15	15.09	TNMS016M1	1.5P	95	26	-	48	12.5	10	13	4	002	○
M16X0.75	P3	15.3	15.33	TNMR016J5	5P	95	15	-	48	12.5	10	13	4	037	○
	P3	15.3	15.33	TNMR016J1	1.5P	95	15	-	48	12.5	10	13	4	037	○
M16X0.5	P2	15.5	15.56	TNMQ016G5	5P	95	13	-	48	12.5	10	13	4	037	○
	P2	15.5	15.56	TNMQ016G1	1.5P	95	13	-	48	12.5	10	13	4	037	○
M17X2	P3	15	15.1	TNMR017Q5	5P	100	33	-	51	14	11	14	4	002	○
	P3	15	15.1	TNMR017Q1	1.5P	100	33	-	51	14	11	14	4	002	○
M17X1.5	P4	15.5	15.6	TNMS017O5	5P	100	33	-	51	14	11	14	4	002	○
	P4	15.5	15.6	TNMS017O1	1.5P	100	33	-	51	14	11	14	4	002	●
M17X1.25	P4	15.8	15.85	TNMS017N5	5P	100	33	-	51	14	11	14	4	002	○
	P4	15.8	15.85	TNMS017N1	1.5P	100	33	-	51	14	11	14	4	002	○
M17X1	P3	16	16.09	TNMR017M5	5P	100	18	-	51	14	11	14	4	037	○
	P3	16	16.09	TNMR017M1	1.5P	100	18	-	51	14	11	14	4	037	●

Intro

SP

SL

PO

ST

JIS

ROLL

CARBIDE

LONG

HAND
TAPS

EG (STI)

SPECIAL
THREADS,
GAUGESTHREAD
MILLS

DIES

CENTER
DRILLSTechnical
info

Straight Fluted Taps

Intro

SP

SL

PO

ST

JIS

ROLL

CARBIDE

LONG

HAND TAPS

EG (STI)

SPECIAL THREADS, GAUGES

THREAD MILLS

DIES

CENTER DRILLS

Technical info

MF	TCTR (tolerance)	\varnothing (mm)	Hole \varnothing (mm)	Code	THCHT (chamfer)	LF (mm)	THL (mm)	LU (mm)	LS (mm)	DCON (mm)	K (mm)	LK (mm)	NOF	Type	Stock
JIS															
M17X0.75	P3	16.3	16.33	TNMR017J5	5P	100	16	-	51	14	11	14	4	037	○
	P3	16.3	16.33	TNMR017J1	1.5P	100	16	-	51	14	11	14	4	037	○
M17X0.5	P2	16.5	16.56	TNMQ017G5	5P	100	13	-	51	14	11	14	4	037	○
	P2	16.5	16.56	TNMQ017G1	1.5P	100	13	-	51	14	11	14	4	037	○
M18X2	P4	16	16.12	TNMS018Q5	5P	100	33	-	51	14	11	14	4	002	○
	P4	16	16.12	TNMS018Q1	1.5P	100	33	-	51	14	11	14	4	002	●
M18X1.5	P3	16.5	16.6	TNMR018O5	5P	100	33	-	51	14	11	14	4	002	○
	P3	16.5	16.6	TNMR018O1	1.5P	100	33	-	51	14	11	14	4	002	●
	P4(P3+20)	16.5	16.6	TNMS018O5	5P	100	33	-	51	14	11	14	4	002	○
	P4(P3+20)	16.5	16.6	TNMS018O1	1.5P	100	33	-	51	14	11	14	4	002	○
	P5(P3+40)	16.5	16.6	TNMT018O5	5P	100	33	-	51	14	11	14	4	002	○
M18X1.25	P4	16.5	16.6	TNMT018O1	1.5P	100	33	-	51	14	11	14	4	002	○
	P4	16.8	16.85	TNMS018N5	5P	100	33	-	51	14	11	14	4	002	○
M18X1	P4	16.8	16.85	TNMS018N1	1.5P	100	33	-	51	14	11	14	4	002	○
	P3	17	17.09	TNMR018M5	5P	100	18	-	51	14	11	14	4	037	○
M18X0.75	P3	17	17.09	TNMR018M1	1.5P	100	18	-	51	14	11	14	4	037	●
	P3	17.3	17.33	TNMR018J5	5P	100	16	-	51	14	11	14	4	037	○
M18X0.5	P3	17.3	17.33	TNMR018J1	1.5P	100	16	-	51	14	11	14	4	037	○
	P2	17.5	17.56	TNMQ018G5	5P	100	13	-	51	14	11	14	4	037	○
M19X2.5	P2	17.5	17.56	TNMQ018G1	1.5P	100	13	-	51	14	11	14	4	037	○
	P4	16.5	16.6	TNMS019R5	5P	105	33	-	50	15	12	15	4	002	○
M19X2	P4	16.5	16.6	TNMS019R1	1.5P	105	33	-	50	15	12	15	4	002	○
	P4	17	17.12	TNMS019Q5	5P	105	33	-	50	15	12	15	4	002	○
M19X1.5	P4	17	17.12	TNMS019Q1	1.5P	105	33	-	50	15	12	15	4	002	○
	P3	17.5	17.6	TNMR019O5	5P	105	33	-	50	15	12	15	4	002	○
M19X1	P3	17.5	17.6	TNMR019O1	1.5P	105	33	-	50	15	12	15	4	002	●
	P3	18	18.09	TNMR019M5	5P	105	18	-	50	15	12	15	4	037	○
M19X0.75	P3	18	18.09	TNMR019M1	1.5P	105	18	-	50	15	12	15	4	037	●
	P3	18.3	18.33	TNMR019J5	5P	105	14	-	50	15	12	15	4	037	○
M19X0.5	P3	18.3	18.33	TNMR019J1	1.5P	105	14	-	50	15	12	15	4	037	○
	P2	18.5	18.56	TNMQ019G5	5P	105	14	-	50	15	12	15	4	037	○
M20X2	P2	18.5	18.56	TNMQ019G1	1.5P	105	14	-	50	15	12	15	4	037	○
	P4	18	18.12	TNMS020Q5	5P	105	33	-	50	15	12	15	4	002	○
M20X1.5	P4	18	18.12	TNMS020Q1	1.5P	105	33	-	50	15	12	15	4	002	●
	P3	18.5	18.6	TNMR020O5	5P	105	33	-	50	15	12	15	4	002	○
M20X1.25	P3	18.5	18.6	TNMR020O1	1.5P	105	33	-	50	15	12	15	4	002	●
	P4(P3+20)	18.5	18.6	TNMS020O5	5P	105	33	-	50	15	12	15	4	002	○
	P4(P3+20)	18.5	18.6	TNMS020O1	1.5P	105	33	-	50	15	12	15	4	002	○
	P5(P3+40)	18.5	18.6	TNMT020O5	5P	105	33	-	50	15	12	15	4	002	○
M20X1	P5(P3+40)	18.5	18.6	TNMT020O1	1.5P	105	33	-	50	15	12	15	4	002	○
	P4	18.8	18.85	TNMS020N5	5P	105	18	-	50	15	12	15	4	037	○
M20X0.75	P4	18.8	18.85	TNMS020N1	1.5P	105	18	-	50	15	12	15	4	037	○
	P3	19	19.09	TNMR020M5	5P	105	18	-	50	15	12	15	4	037	○
M20X0.5	P3	19	19.09	TNMR020M1	1.5P	105	18	-	50	15	12	15	4	037	●
	P3	19.3	19.33	TNMR020J5	5P	105	14	-	50	15	12	15	4	037	○
M20X0.25	P3	19.3	19.33	TNMR020J1	1.5P	105	14	-	50	15	12	15	4	037	○

MF	TCTR (tolerance)	\varnothing (mm)	Hole \varnothing (mm)	Code	THCHT (chamfer)	LF (mm)	THL (mm)	LU (mm)	LS (mm)	DCON (mm)	K (mm)	LK (mm)	NOF	Type	Stock
JIS															
M20X0.5	P2	19.5	19.56	TNMQ020G5	5P	105	14	-	50	15	12	15	4	037	○
	P2	19.5	19.56	TNMQ020G1	1.5P	105	14	-	50	15	12	15	4	037	○
M21X2	P4	19	19.1	TNMS021Q5	5P	115	33	-	55	17	13	16	4	002	○
	P4	19	19.1	TNMS021Q1	1.5P	115	33	-	55	17	13	16	4	002	○
M21X1.5	P3	19.5	19.6	TNMR021O5	5P	115	33	-	55	17	13	16	4	002	○
	P3	19.5	19.6	TNMR021O1	1.5P	115	33	-	55	17	13	16	4	002	○
M21X1	P3	20	20.09	TNMR021M5	5P	115	19	-	55	17	13	16	4	037	○
	P3	20	20.09	TNMR021M1	1.5P	115	19	-	55	17	13	16	4	037	○
M22X2	P4	20	20.12	TNMS022Q5	5P	115	33	-	55	17	13	16	4	002	○
	P4	20	20.12	TNMS022Q1	1.5P	115	33	-	55	17	13	16	4	002	○
M22X1.5	P3	20.5	20.6	TNMR022O5	5P	115	33	-	55	17	13	16	4	002	○
	P3	20.5	20.6	TNMR022O1	1.5P	115	33	-	55	17	13	16	4	002	○
	P4(P3+20)	20.5	20.6	TNMS022O5	5P	115	33	-	55	17	13	16	4	002	○
	P4(P3+20)	20.5	20.6	TNMS022O1	1.5P	115	33	-	55	17	13	16	4	002	○
	P5(P3+40)	20.5	20.6	TNMT022O5	5P	115	33	-	55	17	13	16	4	002	○
	P5(P3+40)	20.5	20.6	TNMT022O1	1.5P	115	33	-	55	17	13	16	4	002	○
M22X1.25	P4	20.8	20.85	TNMS022N5	5P	115	19	-	55	17	13	16	4	037	○
	P4	20.8	20.85	TNMS022N1	1.5P	115	19	-	55	17	13	16	4	037	○
M22X1	P3	21	21.09	TNMR022M5	5P	115	19	-	55	17	13	16	4	037	○
	P3	21	21.09	TNMR022M1	1.5P	115	19	-	55	17	13	16	4	037	○
M22X0.75	P3	21.3	21.33	TNMR022J5	5P	115	14	-	55	17	13	16	4	037	○
	P3	21.3	21.33	TNMR022J1	1.5P	115	14	-	55	17	13	16	4	037	○
M22X0.5	P2	21.5	21.56	TNMQ022G5	5P	115	14	-	55	17	13	16	4	037	○
	P2	21.5	21.56	TNMQ022G1	1.5P	115	14	-	55	17	13	16	4	037	○
M23X2	P4	21	21.1	TNMS023Q5	5P	120	39	-	55	19	15	18	4	002	○
	P4	21	21.1	TNMS023Q1	1.5P	120	39	-	55	19	15	18	4	002	○
M23X1.5	P3	21.5	21.6	TNMR023O5	5P	120	39	-	55	19	15	18	4	002	○
	P3	21.5	21.6	TNMR023O1	1.5P	120	39	-	55	19	15	18	4	002	○
M23X1	P3	22	22.09	TNMR023M5	5P	120	19	-	55	19	15	18	4	037	○
	P3	22	22.09	TNMR023M1	1.5P	120	19	-	55	19	15	18	4	037	○
M24X2	P4	22	22.12	TNMS024Q5	5P	120	39	-	55	19	15	18	4	002	○
	P4	22	22.12	TNMS024Q1	1.5P	120	39	-	55	19	15	18	4	002	○
M24X1.5	P3	22.5	22.6	TNMR024O5	5P	120	39	-	55	19	15	18	4	002	○
	P3	22.5	22.6	TNMR024O1	1.5P	120	39	-	55	19	15	18	4	002	○
	P4(P3+20)	22.5	22.6	TNMS024O5	5P	120	39	-	55	19	15	18	4	002	○
	P4(P3+20)	22.5	22.6	TNMS024O1	1.5P	120	39	-	55	19	15	18	4	002	○
	P5(P3+40)	22.5	22.6	TNMT024O5	5P	120	39	-	55	19	15	18	4	002	○
	P5(P3+40)	22.5	22.6	TNMT024O1	1.5P	120	39	-	55	19	15	18	4	002	○
M24X1.25	P4	22.8	22.85	TNMS024N5	5P	120	19	-	55	19	15	18	4	037	○
	P4	22.8	22.85	TNMS024N1	1.5P	120	19	-	55	19	15	18	4	037	○
M24X1	P3	23	23.09	TNMR024M5	5P	120	19	-	55	19	15	18	4	037	○
	P3	23	23.09	TNMR024M1	1.5P	120	19	-	55	19	15	18	4	037	○
M24X0.75	P3	23.3	23.33	TNMR024J5	5P	120	15	-	55	19	15	18	4	037	○
	P3	23.3	23.33	TNMR024J1	1.5P	120	15	-	55	19	15	18	4	037	○
M24X0.5	P2	23.5	23.56	TNMQ024G5	5P	120	15	-	55	19	15	18	4	037	○
	P2	23.5	23.56	TNMQ024G1	1.5P	120	15	-	55	19	15	18	4	037	○

Intro

SP

SL

PO

ST

JIS

ROLL

CARBIDE

LONG

HAND
TAPS

EG (STI)

SPECIAL
THREADS,
GAUGESTHREAD
MILLS

DIES

CENTER
DRILLSTechnical
info

Straight Fluted Taps

Intro

SP

SL

PO

ST

JIS

ROLL

CARBIDE

LONG

HAND TAPS

EG (STI)

SPECIAL THREADS, GAUGES

THREAD MILLS

DIES

CENTER DRILLS

Technical info

MF	TCTR (tolerance)	\varnothing (mm)	Hole \varnothing (mm)	Code	THCHT (chamfer)	LF (mm)	THL (mm)	LU (mm)	LS (mm)	DCON (mm)	K (mm)	LK (mm)	NOF	Type	Stock
JIS															
M25X3	P4	22	22.12	TNMS025S5	5P	125	39	-	58	19	15	18	4	002	○
	P4	22	22.12	TNMS025S1	1.5P	125	39	-	58	19	15	18	4	002	○
M25X2	P4	23	23.12	TNMS025Q5	5P	125	39	-	58	19	15	18	4	002	○
	P4	23	23.12	TNMS025Q1	1.5P	125	39	-	58	19	15	18	4	002	○
M25X1.5	P3	23.5	23.6	TNMR025O5	5P	125	39	-	58	19	15	18	4	002	○
	P3	23.5	23.6	TNMR025O1	1.5P	125	39	-	58	19	15	18	4	002	○
M25X1	P3	24	24.09	TNMR025M5	5P	125	20	-	58	19	15	18	4	037	○
	P3	24	24.09	TNMR025M1	1.5P	125	20	-	58	19	15	18	4	037	○
M26X3	P4	23	23.12	TNMS026S5	5P	130	39	-	60	20	15	18	4	002	○
	P4	23	23.12	TNMS026S1	1.5P	130	39	-	60	20	15	18	4	002	○
M26X2	P4	24	24.12	TNMS026Q5	5P	130	39	-	60	20	15	18	4	002	○
	P4	24	24.12	TNMS026Q1	1.5P	130	39	-	60	20	15	18	4	002	○
M26X1.5	P3	24.5	24.6	TNMR026O5	5P	130	39	-	60	20	15	18	4	002	○
	P3	24.5	24.6	TNMR026O1	1.5P	130	39	-	60	20	15	18	4	002	○
M26X1	P3	25	25.09	TNMR026M5	5P	130	20	-	60	20	15	18	4	037	○
	P3	25	25.09	TNMR026M1	1.5P	130	20	-	60	20	15	18	4	037	○
M27X2	P5	25	25.12	TNMT027Q5	5P	130	39	-	60	20	15	18	4	002	○
	P5	25	25.12	TNMT027Q1	1.5P	130	39	-	60	20	15	18	4	002	○
M27X1.5	P3	25.5	25.6	TNMR027O5	5P	130	39	-	60	20	15	18	4	002	○
	P3	25.5	25.6	TNMR027O1	1.5P	130	39	-	60	20	15	18	4	002	○
M27X1	P3	26	26.09	TNMR027M5	5P	130	20	-	60	20	15	18	4	037	○
	P3	26	26.09	TNMR027M1	1.5P	130	20	-	60	20	15	18	4	037	○
M28X3	P4	25	25.12	TNMS028S5	5P	135	46	-	62	23	17	20	4	002	○
	P4	25	25.12	TNMS028S1	1.5P	135	46	-	62	23	17	20	4	002	○
M28X2	P4	26	26.12	TNMS028Q5	5P	135	46	-	62	23	17	20	4	002	○
	P4	26	26.12	TNMS028Q1	1.5P	135	46	-	62	23	17	20	4	002	○
M28X1.5	P3	26.5	26.6	TNMR028O5	5P	135	46	-	62	23	17	20	4	002	○
	P3	26.5	26.6	TNMR028O1	1.5P	135	46	-	62	23	17	20	4	002	○
M28X1	P3	27	27.09	TNMR028M5	5P	135	20	-	62	23	17	20	4	037	○
	P3	27	27.09	TNMR028M1	1.5P	135	20	-	62	23	17	20	4	037	○
M29X1.5	P3	27.5	27.6	TNMR029O5	5P	135	46	-	62	23	17	20	4	002	○
	P3	27.5	27.6	TNMR029O1	1.5P	135	46	-	62	23	17	20	4	002	○
M30X3	P5	27	27.13	TNMT030S5	5P	135	46	-	62	23	17	20	4	002	○
	P5	27	27.13	TNMT030S1	1.5P	135	46	-	62	23	17	20	4	002	○
M30X2	P4	28	28.12	TNMS030Q5	5P	135	46	-	62	23	17	20	4	002	○
	P4	28	28.12	TNMS030Q1	1.5P	135	46	-	62	23	17	20	4	002	○
M30X1.5	P3	28.5	28.6	TNMR030O5	5P	135	46	-	62	23	17	20	4	002	○
	P3	28.5	28.6	TNMR030O1	1.5P	135	46	-	62	23	17	20	4	002	○
M30X1	P3	29	29.09	TNMR030M5	5P	135	21	-	62	23	17	20	4	037	○
	P3	29	29.09	TNMR030M1	1.5P	135	21	-	62	23	17	20	4	037	○
M32X3.5	P4	28.5	28.6	TNMS032T5	5P	145	46	-	67	24	19	22	4	002	○
	P4	28.5	28.6	TNMS032T1	1.5P	145	46	-	67	24	19	22	4	002	○
M32X3	P5	29	29.13	TNMT032S5	5P	145	46	-	67	24	19	22	4	002	○
	P5	29	29.13	TNMT032S1	1.5P	145	46	-	67	24	19	22	4	002	○
M32X2	P4	30	30.12	TNMS032Q5	5P	145	46	-	67	24	19	22	4	002	○
	P4	30	30.12	TNMS032Q1	1.5P	145	46	-	67	24	19	22	4	002	○

MF	TCTR (tolerance)	 Hole Ø (mm)	Hole Ø (mm)	Code	THCHT (chamfer)	LF (mm)	THL (mm)	LU (mm)	LS (mm)	DCON (mm)	K (mm)	LK (mm)	NOF	Type	Stock
JIS															
M32X1.5	P4	30.5	30.6	TNMS03205	5P	145	46	-	67	24	19	22	4	002	○
	P4	30.5	30.6	TNMS03201	1.5P	145	46	-	67	24	19	22	4	002	○
M32X1	P3	31	31.09	TNMR032M5	5P	145	21	-	67	24	19	22	4	037	○
	P3	31	31.09	TNMR032M1	1.5P	145	21	-	67	24	19	22	4	037	○
M33X3	P5	30	30.13	TNMT033S5	5P	145	46	-	67	25	19	22	4	002	○
	P5	30	30.13	TNMT033S1	1.5P	145	46	-	67	25	19	22	4	002	○
M33X2	P4	31	31.12	TNMS033Q5	5P	145	46	-	67	25	19	22	4	002	○
	P4	31	31.12	TNMS033Q1	1.5P	145	46	-	67	25	19	22	4	002	○
M33X1.5	P4	31.5	31.6	TNMS033O5	5P	145	46	-	67	25	19	22	4	002	○
	P4	31.5	31.6	TNMS033O1	1.5P	145	46	-	67	25	19	22	4	002	○
M33X1	P3	32	32.09	TNMR033M5	5P	145	21	-	67	25	19	22	4	037	○
	P3	32	32.09	TNMR033M1	1.5P	145	21	-	67	25	19	22	4	037	○
M34X3	P5	31	31.13	TNMT034S5	5P	155	52	-	71	28	21	24	4	002	○
	P5	31	31.13	TNMT034S1	1.5P	155	52	-	71	28	21	24	4	002	○
M34X2	P4	32	32.12	TNMS034Q5	5P	155	52	-	71	28	21	24	4	002	○
	P4	32	32.12	TNMS034Q1	1.5P	155	52	-	71	28	21	24	4	002	○
M34X1.5	P4	35.5	32.6	TNMS034O5	5P	155	26	-	71	28	21	24	4	037	○
	P4	35.5	32.6	TNMS034O1	1.5P	155	26	-	71	28	21	24	4	037	○
M34X1	P3	33	33.09	TNMR034M5	5P	155	26	-	71	28	21	24	4	037	○
	P3	33	33.09	TNMR034M1	1.5P	155	26	-	71	28	21	24	4	037	○
M35X3	P5	32	32.13	TNMT035S5	5P	155	52	-	71	28	21	24	4	002	○
	P5	32	32.13	TNMT035S1	1.5P	155	52	-	71	28	21	24	4	002	○
M35X2	P5	33	33.12	TNMT035Q5	5P	155	52	-	71	28	21	24	4	002	○
	P5	33	33.12	TNMT035Q1	1.5P	155	52	-	71	28	21	24	4	002	○
M35X1.5	P4	33.5	33.6	TNMS035O5	5P	155	26	-	71	28	21	24	4	037	○
	P4	33.5	33.6	TNMS035O1	1.5P	155	26	-	71	28	21	24	4	037	○
M35X1	P3	34	34.09	TNMR035M5	5P	155	26	-	71	28	21	24	4	037	○
	P3	34	34.09	TNMR035M1	1.5P	155	26	-	71	28	21	24	4	037	○
M36X3	P5	33	33.13	TNMT036S5	5P	155	52	-	71	28	21	24	4	002	○
	P5	33	33.13	TNMT036S1	1.5P	155	52	-	71	28	21	24	4	002	○
M36X2	P4	34	34.12	TNMS036Q5	5P	155	52	-	71	28	21	24	4	002	○
	P4	34	34.12	TNMS036Q1	1.5P	155	52	-	71	28	21	24	4	002	○
M36X1.5	P4	34.5	34.6	TNMS036O5	5P	155	26	-	71	28	21	24	4	037	○
	P4	34.5	34.6	TNMS036O1	1.5P	155	26	-	71	28	21	24	4	037	○
M36X1	P3	35	35.09	TNMR036M5	5P	155	26	-	71	28	21	24	4	037	○
	P3	35	35.09	TNMR036M1	1.5P	155	26	-	71	28	21	24	4	037	○
M37X1.5	P4	35.5	35.6	TNMS037O5	5P	165	26	-	76	30	23	26	4	037	○
	P4	35.5	35.6	TNMS037O1	1.5P	165	26	-	76	30	23	26	4	037	○
M38X3	P5	35	35.13	TNMT038S5	5P	165	52	-	76	30	23	26	4	002	○
	P5	35	35.13	TNMT038S1	1.5P	165	52	-	76	30	23	26	4	002	○
M38X2	P4	36	36.12	TNMS038Q5	5P	165	52	-	76	30	23	26	4	002	○
	P4	36	36.12	TNMS038Q1	1.5P	165	52	-	76	30	23	26	4	002	○
M38X1.5	P4	36.5	36.6	TNMS038O5	5P	165	26	-	76	30	23	26	4	037	○
	P4	36.5	36.6	TNMS038O1	1.5P	165	26	-	76	30	23	26	4	037	○
M38X1	P3	37	37.09	TNMR038M5	5P	165	26	-	76	30	23	26	4	037	○
	P3	37	37.09	TNMR038M1	1.5P	165	26	-	76	30	23	26	4	037	○

Intro

SP

SL

PO

ST

JIS

ROLL

CARBIDE

LONG

HAND TAPS

EG (STI)

SPECIAL THREADS, GAUGES

THREAD MILLS

DIES

CENTER DRILLS

Technical info

Straight Fluted Taps

Intro

SP

SL

PO

ST

JIS

ROLL

CARBIDE

LONG

HAND TAPS

EG (STI)

SPECIAL THREADS, GAUGES

THREAD MILLS

DIES

CENTER DRILLS

Technical info

MF	TCTR (tolerance)	\varnothing (mm)	Hole \varnothing (mm)	Code	THCHT (chamfer)	LF (mm)	THL (mm)	LU (mm)	LS (mm)	DCON (mm)	K (mm)	LK (mm)	NOF	Type	Stock
JIS															
M39X3	P5	36	36.13	TNMT039S5	5P	165	52	-	76	30	23	26	4	002	○
	P5	36	36.13	TNMT039S1	1.5P	165	52	-	76	30	23	26	4	002	○
M39X2	P5	37	37.12	TNMT039Q5	5P	165	52	-	76	30	23	26	4	002	○
	P5	37	37.12	TNMT039Q1	1.5P	165	52	-	76	30	23	26	4	002	○
M39X1.5	P4	37.5	37.6	TNMS039Q5	5P	165	26	-	76	30	23	26	4	037	○
	P4	37.5	37.6	TNMS039Q1	1.5P	165	26	-	76	30	23	26	4	037	○
M39X1	P3	38	38.09	TNMR039M5	5P	165	26	-	76	30	23	26	4	037	○
	P3	38	38.09	TNMR039M1	1.5P	165	26	-	76	30	23	26	4	037	○
M40X4	P5	36	36.14	TNMT040U5	5P	175	59	-	81	32	26	30	4	002	○
	P5	36	36.14	TNMT040U1	1.5P	175	59	-	81	32	26	30	4	002	○
M40X3	P5	37	37.13	TNMT040S5	5P	175	59	-	81	32	26	30	4	002	○
	P5	37	37.13	TNMT040S1	1.5P	175	59	-	81	32	26	30	4	002	○
M40X2	P4	38	38.12	TNMS040Q5	5P	175	59	-	81	32	26	30	4	002	○
	P4	38	38.12	TNMS040Q1	1.5P	175	59	-	81	32	26	30	4	002	○
M40X1.5	P4	38.5	38.6	TNMS040Q5	5P	175	27	-	81	32	26	30	4	037	○
	P4	38.5	38.6	TNMS040Q1	1.5P	175	27	-	81	32	26	30	4	037	○
M40X1	P3	39	39.09	TNMR040M5	5P	175	27	-	81	32	26	30	4	037	○
	P3	39	39.09	TNMR040M1	1.5P	175	27	-	81	32	26	30	4	037	○
M42X4	P6	38	38.12	TNMTU042U5	5P	175	59	-	81	32	26	30	4	002	○
	P6	38	38.12	TNMTU042U1	1.5P	175	59	-	81	32	26	30	4	002	○
M42X3	P5	39	39.13	TNMT042S5	5P	175	59	-	81	32	26	30	4	002	○
	P5	39	39.13	TNMT042S1	1.5P	175	59	-	81	32	26	30	4	002	○
M42X2	P4	40	40.12	TNMS042Q5	5P	175	59	-	81	32	26	30	4	002	○
	P4	40	40.12	TNMS042Q1	1.5P	175	59	-	81	32	26	30	4	002	○
M42X1.5	P4	40.5	40.6	TNMS042Q5	5P	175	27	-	81	32	26	30	4	037	○
	P4	40.5	40.6	TNMS042Q1	1.5P	175	27	-	81	32	26	30	4	037	○
M42X1	P3	41	41.09	TNMR042M5	5P	175	27	-	81	32	26	30	4	037	○
	P3	41	41.09	TNMR042M1	1.5P	175	27	-	81	32	26	30	4	037	○
M44X4	P6	40	40.14	TNMTU044U5	5P	180	59	-	83	35	26	30	4	002	○
	P6	40	40.14	TNMTU044U1	1.5P	180	59	-	83	35	26	30	4	002	○
M44X3	P5	41	41.13	TNMT044S5	5P	180	59	-	83	35	26	30	4	002	○
	P5	41	41.13	TNMT044S1	1.5P	180	59	-	83	35	26	30	4	002	○
M44X2	P4	42	42.12	TNMS044Q5	5P	180	59	-	83	35	26	30	4	002	○
	P4	42	42.12	TNMS044Q1	1.5P	180	59	-	83	35	26	30	4	002	○
M44X1.5	P4	42.5	42.6	TNMS044Q5	5P	180	27	-	83	35	26	30	4	037	○
	P4	42.5	42.6	TNMS044Q1	1.5P	180	27	-	83	35	26	30	4	037	○
M44X1	P3	43	43.09	TNMR044M5	5P	180	27	-	83	35	26	30	4	037	○
	P3	43	43.09	TNMR044M1	1.5P	180	27	-	83	35	26	30	4	037	○
M45X4	P6	41	41.12	TNMTU045U5	5P	180	59	-	83	35	26	30	4	002	○
	P6	41	41.12	TNMTU045U1	1.5P	180	59	-	83	35	26	30	4	002	○
M45X3	P5	42	42.13	TNMT045S5	5P	180	59	-	83	35	26	30	4	002	○
	P5	42	42.13	TNMT045S1	1.5P	180	59	-	83	35	26	30	4	002	○
M45X2	P4	43	43.12	TNMS045Q5	5P	180	59	-	83	35	26	30	4	002	○
	P4	43	43.12	TNMS045Q1	1.5P	180	59	-	83	35	26	30	4	002	○
M45X1.5	P4	43.5	43.6	TNMS045Q5	5P	180	27	-	83	35	26	30	4	037	○
	P4	43.5	43.6	TNMS045Q1	1.5P	180	27	-	83	35	26	30	4	037	○

MF	TCTR (tolerance)	 Hole Ø (mm)	Hole Ø (mm)	Code	THCHT (chamfer)	LF (mm)	THL (mm)	LU (mm)	LS (mm)	DCON (mm)	K (mm)	LK (mm)	NOF	Type	Stock
JIS															
M45X1	P3	44	44.09	TNMR045M5	5P	180	27	-	83	35	26	30	4	037	○
	P3	44	44.09	TNMR045M1	1.5P	180	27	-	83	35	26	30	4	037	○
M46X4	P6	42	42.12	TNMMU046U5	5P	185	65	-	85	38	29	32	4	002	○
	P6	42	42.12	TNMMU046U1	1.5P	185	65	-	85	38	29	32	4	002	○
M46X3	P6	43	43.13	TNMMU046S5	5P	185	65	-	85	38	29	32	4	002	○
	P6	43	43.13	TNMMU046S1	1.5P	185	65	-	85	38	29	32	4	002	○
M46X2	P4	44	44.12	TNMS046Q5	5P	185	65	-	85	38	29	32	4	002	○
	P4	44	44.12	TNMS046Q1	1.5P	185	65	-	85	38	29	32	4	002	○
M46X1.5	P4	44.5	44.6	TNMS046O5	5P	185	28	-	85	38	29	32	4	037	○
	P4	44.5	44.6	TNMS046O1	1.5P	185	28	-	85	38	29	32	4	037	○
M48X4	P6	44	44.12	TNMMU048U5	5P	185	65	-	85	38	29	32	4	002	○
	P6	44	44.12	TNMMU048U1	1.5P	185	65	-	85	38	29	32	4	002	○
M48X3	P6	45	45.13	TNMMU048S5	5P	185	65	-	85	38	29	32	4	002	○
	P6	45	45.13	TNMMU048S1	1.5P	185	65	-	85	38	29	32	4	002	○
M48X2	P4	46	46.12	TNMS048Q5	5P	185	65	-	85	38	29	32	4	002	○
	P4	46	46.12	TNMS048Q1	1.5P	185	65	-	85	38	29	32	4	002	○
M48X1.5	P4	46.5	46.6	TNMS048O5	5P	185	28	-	85	38	29	32	4	037	○
	P4	46.5	46.6	TNMS048O1	1.5P	185	28	-	85	38	29	32	4	037	○
M48X1	P3	47	47.09	TNMR048M5	5P	185	28	-	85	38	29	32	4	037	○
	P3	47	47.09	TNMR048M1	1.5P	185	28	-	85	38	29	32	4	037	○
M50X5	II	45	45.12	TH2050W5	5P	195	90	-	105	40	32	35	4	002	○
	II	45	45.12	TH2050W1	1.5P	195	90	-	105	40	32	35	4	002	○
M50X4	II	46	46.12	TH2050U5	5P	180	80	-	100	40	32	35	4	002	○
	II	46	46.12	TH2050U1	1.5P	180	80	-	100	40	32	35	4	002	○
M50X3	II	47	47.13	TH2050S5	5P	180	80	-	100	40	32	35	4	002	○
	II	47	47.13	TH2050S1	1.5P	180	80	-	100	40	32	35	4	002	○
M50X2	II	48	48.12	TH2050Q5	5P	130	45	-	85	40	32	35	4	002	○
	II	48	48.12	TH2050Q1	1.5P	130	45	-	85	40	32	35	4	002	○
M50X1.5	II	48.5	48.6	TH2050O5	5P	130	45	-	85	40	32	35	4	002	○
	II	48.5	48.6	TH2050O1	1.5P	130	45	-	85	40	32	35	4	002	○
M50X1	II	49	49.09	TH2050M5	5P	130	30	-	100	40	32	35	4	002	○
	II	49	49.09	TH2050M1	1.5P	130	30	-	100	40	32	35	4	002	○
M52X4	II	48	48.1	TH2052U5	5P	180	80	-	100	42	32	35	4	002	○
	II	48	48.1	TH2052U1	1.5P	180	80	-	100	42	32	35	4	002	○
M52X3	II	49	49.1	TH2052S5	5P	180	80	-	100	42	32	35	4	002	○
	II	49	49.1	TH2052S1	1.5P	180	80	-	100	42	32	35	4	002	○
M52X2	II	50	50.1	TH2052Q5	5P	130	50	-	80	42	32	35	4	002	○
	II	50	50.1	TH2052Q1	1.5P	130	50	-	80	42	32	35	4	002	○
M52X1.5	II	50.5	50.6	TH2052O5	5P	130	45	-	85	42	32	35	4	002	○
	II	50.5	50.6	TH2052O1	1.5P	130	45	-	85	42	32	35	4	002	○
M55X4	II	51	51.1	TH2055U5	5P	180	80	-	100	44	35	38	4	002	○
	II	51	51.1	TH2055U1	1.5P	180	80	-	100	44	35	38	4	002	○
M55X3	II	52	52.1	TH2055S5	5P	180	80	-	100	44	35	38	4	002	○
	II	52	52.1	TH2055S1	1.5P	180	80	-	100	44	35	38	4	002	○
M55X2	II	53	53.1	TH2055Q5	5P	135	50	-	85	44	35	38	4	002	○
	II	53	53.1	TH2055Q1	1.5P	135	50	-	85	44	35	38	4	002	○

Intro

SP

SL

PO

ST
JIS

ROLL

CARBIDE

LONG

HAND TAPS

EG (STI)

SPECIAL THREADS, GAUGES

THREAD MILLS

DIES

CENTER DRILLS

Technical info

Straight Fluted Taps

Intro

	MF	TCTR (tolerance)	\varnothing (mm)	Hole \varnothing (mm)	Code	THCHT (chamfer)	LF (mm)	THL (mm)	LU (mm)	LS (mm)	DCON (mm)	K (mm)	LK (mm)	NOF	Type	Stock
JIS																
SP	M55X1.5		53.5	53.6	TH205505	5P	135	45	-	90	44	35	38	4	002	○
			53.5	53.6	TH205501	1.5P	135	45	-	90	44	35	38	4	002	○
	M56X4		52	52.1	TH2056U5	5P	180	80	-	100	44	35	38	4	002	○
			52	52.1	TH2056U1	1.5P	180	80	-	100	44	35	38	4	002	○
SL	M56X3		53	53.1	TH2056S5	5P	180	80	-	100	44	35	38	4	002	○
			53	53.1	TH2056S1	1.5P	180	80	-	100	44	35	38	4	002	○
	M56X2		54	54.1	TH2056Q5	5P	135	50	-	85	44	35	38	4	002	○
			54	54.1	TH2056Q1	1.5P	135	50	-	85	44	35	38	4	002	○
PO	M56X1.5		54.5	54.6	TH2056O5	5P	135	45	-	90	44	35	38	4	002	○
			54.5	54.6	TH2056O1	1.5P	135	45	-	90	44	35	38	4	002	○
ST	M58X4		54	54.1	TH2058U5	5P	180	80	-	100	46	35	38	4	002	○
			54	54.1	TH2058U1	1.5P	180	80	-	100	46	35	38	4	002	○
JIS	M58X3		55	55.1	TH2058S5	5P	180	80	-	100	46	35	38	4	002	○
			55	55.1	TH2058S1	1.5P	180	80	-	100	46	35	38	4	002	○
ROLL	M58X2		56	56.1	TH2058Q5	5P	135	50	-	85	46	35	38	4	002	○
			56	56.1	TH2058Q1	1.5P	135	50	-	85	46	35	38	4	002	○
	M58X1.5		56.5	56.6	TH2058O5	5P	135	45	-	90	46	35	38	4	002	○
			56.5	56.6	TH2058O1	1.5P	135	45	-	90	46	35	38	4	002	○
CARBIDE	M60X4		56	56.1	TH2060U5	5P	185	85	-	100	46	35	38	4	002	○
			56	56.1	TH2060U1	1.5P	185	85	-	100	46	35	38	4	002	○
	M60X3		57	57.1	TH2060S5	5P	185	85	-	100	46	35	38	4	002	○
			57	57.1	TH2060S1	1.5P	185	85	-	100	46	35	38	4	002	○
LONG	M60X2		58	58.1	TH2060Q5	5P	140	55	-	85	46	35	38	4	002	○
			58	58.1	TH2060Q1	1.5P	140	55	-	85	46	35	38	4	002	○
	M60X1.5		58.5	58.6	TH2060O5	5P	140	45	-	95	46	35	38	4	002	○
			58.5	58.6	TH2060O1	1.5P	140	45	-	95	46	35	38	4	002	○
HAND TAPS	M62X4		58	58.1	TH2062U5	5P	185	85	-	100	48	38	48	4	002	○
			58	58.1	TH2062U1	1.5P	185	85	-	100	48	38	48	4	002	○
	M62X3		59	59.1	TH2062S5	5P	185	85	-	100	48	38	48	4	002	○
			59	59.1	TH2062S1	1.5P	185	85	-	100	48	38	48	4	002	○
EG (STI)	M62X2		60	60.1	TH2062Q5	5P	140	55	-	85	48	38	48	4	002	○
			60	60.1	TH2062Q1	1.5P	140	55	-	85	48	38	48	4	002	○
SPECIAL THREADS, GAUGES	M62X1.5		60.5	60.6	TH2062O5	5P	140	45	-	95	48	38	48	4	002	○
			60.5	60.6	TH2062O1	1.5P	140	45	-	95	48	38	48	4	002	○
	M64X4		60	60.1	TH2064U5	5P	185	85	-	100	48	38	42	4	002	○
			60	60.1	TH2064U1	1.5P	185	85	-	100	48	38	42	4	002	○
THREAD MILLS	M64X3		61	61.1	TH2064S5	5P	185	85	-	100	48	38	42	4	002	○
			61	61.1	TH2064S1	1.5P	185	85	-	100	48	38	42	4	002	○
	M64X2		62	62.1	TH2064Q5	5P	140	55	-	85	48	38	42	4	002	○
			62	62.1	TH2064Q1	1.5P	140	55	-	85	48	38	42	4	002	○
DIES	M64X1.5		62.5	62.6	TH2064O5	5P	140	45	-	95	48	38	42	4	002	○
			62.5	62.6	TH2064O1	1.5P	140	45	-	95	48	38	42	4	002	○
	M65X6		59	59.1	TH2065Y5	5P	225	105	-	120	50	38	42	4	002	○
			59	59.1	TH2065Y1	1.5P	225	105	-	120	50	38	42	4	002	○
CENTER DRILLS	M65X4		61	61.1	TH2065U5	5P	185	85	-	100	50	38	42	4	002	○
			61	61.1	TH2065U1	1.5P	185	85	-	100	50	38	42	4	002	○

Technical info

MF	TCTR (tolerance)	 Hole Ø (mm)	Hole Ø (mm)	Code	THCHT (chamfer)	LF (mm)	THL (mm)	LU (mm)	LS (mm)	DCON (mm)	K (mm)	LK (mm)	NOF	Type	Stock
JIS															
M65X3		62	62.1	TH2065S5	5P	185	85	-	100	50	38	42	4	002	○
		62	62.1	TH2065S1	1.5P	185	85	-	100	50	38	42	4	002	○
M65X2		63	63.1	TH2065Q5	5P	140	55	-	85	50	38	42	4	002	○
		63	63.1	TH2065Q1	1.5P	140	55	-	85	50	38	42	4	002	○
M65X1.5		63.5	63.6	TH2065O5	5P	140	45	-	95	50	38	42	4	002	○
		63.5	63.6	TH2065O1	1.5P	140	45	-	95	50	38	42	4	002	○
M68X4		64	64.1	TH2068U5	5P	190	85	-	105	52	41	44	4	002	○
		64	64.1	TH2068U1	1.5P	190	85	-	105	52	41	44	4	002	○
M68X3		65	65.1	TH2068S5	5P	190	85	-	105	52	41	44	4	002	○
		65	65.1	TH2068S1	1.5P	190	85	-	105	52	41	44	4	002	○
M68X2		66	66.1	TH2068Q5	5P	140	55	-	85	52	41	44	4	002	○
		66	66.1	TH2068Q1	1.5P	140	55	-	85	52	41	44	4	002	○
M68X1.5		66.5	66.6	TH2068O5	5P	140	45	-	95	52	41	44	4	002	○
		66.5	66.6	TH2068O1	1.5P	140	45	-	95	52	41	44	4	002	○
M70X4		66	66.1	TH2070U5	5P	190	85	-	105	55	41	44	4	002	○
		66	66.1	TH2070U1	1.5P	190	85	-	105	55	41	44	4	002	○
M70X3		67	67.1	TH2070S5	5P	190	85	-	105	55	41	44	4	002	○
		67	67.1	TH2070S1	1.5P	190	85	-	105	55	41	44	4	002	○
M70X2		68	68.1	TH2070Q5	5P	140	55	-	85	55	41	44	4	002	○
		68	68.1	TH2070Q1	1.5P	140	55	-	85	55	41	44	4	002	○
M70X1.5		68.5	68.6	TH2070O5	5P	140	45	-	95	55	41	44	4	002	○
		68.5	68.6	TH2070O1	1.5P	140	45	-	95	55	41	44	4	002	○
M72X4		68	68.1	TH2072U5	5P	190	85	-	105	55	41	44	4	002	○
		68	68.1	TH2072U1	1.5P	190	85	-	105	55	41	44	4	002	○
M72X3		69	69.1	TH2072S5	5P	190	85	-	105	55	41	44	4	002	○
		69	69.1	TH2072S1	1.5P	190	85	-	105	55	41	44	4	002	○
M72X2		70	70.1	TH2072Q5	5P	140	55	-	85	55	41	44	4	002	○
		70	70.1	TH2072Q1	1.5P	140	55	-	85	55	41	44	4	002	○
M72X1.5		70.5	70.6	TH2072O5	5P	140	45	-	95	55	41	44	4	002	○
		70.5	70.6	TH2072O1	1.5P	140	45	-	95	55	41	44	4	002	○
M75X6		69	69.1	TH2075Y5	5P	240	115	-	125	58	46	50	4	002	○
		69	69.1	TH2075Y1	1.5P	240	115	-	125	58	46	50	4	002	○
M75X4		71	71.1	TH2075U5	5P	190	85	-	105	58	46	50	4	002	○
		71	71.1	TH2075U1	1.5P	190	85	-	105	58	46	50	4	002	○
M75X3		72	72.1	TH2075S5	5P	190	85	-	105	58	46	50	4	002	○
		72	72.1	TH2075S1	1.5P	190	85	-	105	58	46	50	4	002	○
M75X2		73	73.1	TH2075Q5	5P	145	55	-	90	58	46	50	4	002	○
		73	73.1	TH2075Q1	1.5P	145	55	-	90	58	46	50	4	002	○
M75X1.5		73.5	73.6	TH2075O5	5P	145	50	-	95	58	46	50	4	002	○
		73.5	73.6	TH2075O1	1.5P	145	50	-	95	58	46	50	4	002	○
M76X4		72	72.1	TH2076U5	5P	190	85	-	105	58	46	50	4	002	○
		72	72.1	TH2076U1	1.5P	190	85	-	105	58	46	50	4	002	○
M76X3		73	73.1	TH2076S5	5P	190	85	-	105	58	46	50	4	002	○
		73	73.1	TH2076S1	1.5P	190	85	-	105	58	46	50	4	002	○
M76X2		74	74.1	TH2076Q5	5P	145	55	-	90	58	46	50	4	002	○
		74	74.1	TH2076Q1	1.5P	145	55	-	90	58	46	50	4	002	○

Intro

SP

SL

PO

ST
JIS

ROLL

CARBIDE

LONG

HAND TAPS

EG (STI)

SPECIAL THREADS, GAUGES

THREAD MILLS



DIES

CENTER DRILLS

Technical info

Straight Fluted Taps

Intro

	MF	TCTR (tolerance)	 Hole Ø (mm)	Hole Ø (mm)	Code	THCHT (chamfer)	LF (mm)	THL (mm)	LU (mm)	LS (mm)	DCON (mm)	K (mm)	LK (mm)	NOF	Type	Stock
	JIS															
SP	M76X1.5		74.5	74.6	TH207605	5P	145	50	-	95	58	46	50	4	002	○
			74.5	74.6	TH207601	1.5P	145	50	-	95	58	46	50	4	002	○
SL	M78X3		75	75.1	TH2078S5	5P	190	85	-	105	58	46	50	6	002	○
			75	75.1	TH2078S1	1.5P	190	85	-	105	58	46	50	6	002	○
PO	M80X4		76	76.1	TH2078Q5	5P	150	55	-	95	58	46	50	6	002	○
			76	76.1	TH2078Q1	1.5P	150	55	-	95	58	46	50	6	002	○
ST	M80X3		76	76.1	TH2080U5	5P	190	85	-	105	58	46	50	6	002	○
			76	76.1	TH2080U1	1.5P	190	85	-	105	58	46	50	6	002	○
ROLL	M80X2		77	77.1	TH2080S5	5P	190	85	-	105	58	46	50	6	002	○
			77	77.1	TH2080S1	1.5P	190	85	-	105	58	46	50	6	002	○
CARBIDE	M80X2		78	78.1	TH2080Q5	5P	145	55	-	90	58	46	50	6	002	○
			78	78.1	TH2080Q1	1.5P	145	55	-	90	58	46	50	6	002	○
LONG	M80X1.5		78.5	78.6	TH208005	5P	145	50	-	95	58	46	50	6	002	○
			78.5	78.6	TH208001	1.5P	145	50	-	95	58	46	50	6	002	○
HAND TAPS	M82X2		80	80.1	TH2082Q5	5P	145	55	-	90	58	46	50	6	002	○
			80	80.1	TH2082Q1	1.5P	145	55	-	90	58	46	50	6	002	○
EG (STI)	M85X4		81	81.1	TH2085U5	5P	190	85	-	105	60	46	50	6	002	○
			81	81.1	TH2085U1	1.5P	190	85	-	105	60	46	50	6	002	○
SPECIAL THREADS, GAUGES	M85X3		82	82.1	TH2085S5	5P	190	85	-	105	60	46	50	6	002	○
			82	82.1	TH2085S1	1.5P	190	85	-	105	60	46	50	6	002	○
THREAD MILLS	M85X2		83	83.1	TH2085Q5	5P	150	55	-	95	60	46	50	6	002	○
			83	83.1	TH2085Q1	1.5P	150	55	-	95	60	46	50	6	002	○
DIES	M90X4		86	86.1	TH2090U5	5P	195	90	-	105	60	46	50	6	002	○
			86	86.1	TH2090U1	1.5P	195	90	-	105	60	46	50	6	002	○
CENTER DRILLS	M90X3		87	87.1	TH2090S5	5P	195	90	-	105	60	46	50	6	002	○
			87	87.1	TH2090S1	1.5P	195	90	-	105	60	46	50	6	002	○
	M90X2		88	88.1	TH2090Q5	5P	155	60	-	95	60	46	50	6	002	○
			88	88.1	TH2090Q1	1.5P	155	60	-	95	60	46	50	6	002	○
	M95X4		91	91.1	TH2095U5	5P	200	90	-	110	65	50	52	6	002	○
			91	91.1	TH2095U1	1.5P	200	90	-	110	65	50	52	6	002	○
	M95X3		92	92.1	TH2095S5	5P	200	90	-	110	65	50	52	6	002	○
			92	92.1	TH2095S1	1.5P	200	90	-	110	65	50	52	6	002	○
	M95X2		93	93.1	TH2095Q5	5P	155	60	-	95	65	50	52	6	002	○
			93	93.1	TH2095Q1	1.5P	155	60	-	95	65	50	52	6	002	○
	M100X4		96	96.1	TH2100U5	5P	200	90	-	110	65	50	52	6	002	○
			96	96.1	TH2100U1	1.5P	200	90	-	110	65	50	52	6	002	○
	M100X3		97	97.1	TH2100S5	5P	200	90	-	110	65	50	52	6	002	○
			97	97.1	TH2100S1	1.5P	200	90	-	110	65	50	52	6	002	○
	M100X2		98	98.1	TH2100Q5	5P	155	60	-	95	65	50	52	6	002	○
			98	98.1	TH2100Q1	1.5P	155	60	-	95	65	50	52	6	002	○
	JIS															
	UNC	TCTR (tolerance)	 Hole Ø (mm)	Hole Ø (mm)	Code	THCHT (chamfer)	LF (mm)	THL (mm)	LU (mm)	LS (mm)	DCON (mm)	K (mm)	LK (mm)	NOF	Type	Stock
CENTER DRILLS	No.1-64UNC	P1	1.54	1.55	TNMPUN1D5	5P	42	7.2	-	27	3	2.5	5	3	005	○
		P1	1.54	1.55	TNMPUN1D1	1.5P	42	7.2	-	27	3	2.5	5	3	005	○
	No.2-56UNC	P1	1.8	1.83	TNMPUN2E5	5P	42	8.1	12	27	3	2.5	5	3	001	○
		P1	1.8	1.83	TNMPUN2E1	1.5P	42	8.1	12	27	3	2.5	5	3	001	○



Technical info

UNC	TCTR (tolerance)	\varnothing (mm)	Hole \varnothing (mm)	Code	THCHT (chamfer)	LF (mm)	THL (mm)	LU (mm)	LS (mm)	DCON (mm)	K (mm)	LK (mm)	NOF	Type	Stock	Intro
JIS																
No.3-48UNC	P1	2.09	2.1	TNPUN3F5	5P	46	8.1	14	29	3	2.5	5	3	001	○	
	P1	2.09	2.1	TNPUN3F1	1.5P	46	8.1	14	29	3	2.5	5	3	001	○	SP
No.4-40UNC	P2	2.3	2.33	TNMQU4H5	5P	46	9	14	26	4	3.2	6	3	001	○	
	P2	2.3	2.33	TNMQU4H1	1.5P	46	9	14	26	4	3.2	6	3	001	○	
	P3(P2+15)	2.3	2.33	TNMRUN4H5	5P	46	9	14	26	4	3.2	6	3	001	○	SL
	P3(P2+15)	2.3	2.33	TNMRUN4H1	1.5P	46	9	14	26	4	3.2	6	3	001	○	
No.5-40UNC	P2	2.6	2.64	TNMQU5H5	5P	52	11	16	29	5	4	7	3	001	○	
	P2	2.6	2.64	TNMQU5H1	1.5P	52	11	16	29	5	4	7	3	001	○	PO
	P3(P2+15)	2.6	2.64	TNMRUN5H5	5P	52	11	16	29	5	4	7	3	001	○	
	P3(P2+15)	2.6	2.64	TNMRUN5H1	1.5P	52	11	16	29	5	4	7	3	001	○	
No.6-32UNC	P2	2.8	2.83	TNMQU6J5	5P	52	11	16	29	5	4	7	3	001	○	
	P2	2.8	2.83	TNMQU6J1	1.5P	52	11	16	29	5	4	7	3	001	○	
	P3(P2+20)	2.8	2.83	TNMRUN6J5	5P	52	11	16	29	5	4	7	3	001	○	ST
	P3(P2+20)	2.8	2.83	TNMRUN6J1	1.5P	52	11	16	29	5	4	7	3	001	○	JIS
No.8-32UNC	P2	3.4	3.47	TNMQU8J5	5P	60	13	21	33	5.5	4.5	7	4	001	○	
	P2	3.4	3.47	TNMQU8J1	1.5P	60	13	21	33	5.5	4.5	7	4	001	○	
	P3(P2+20)	3.4	3.47	TNMRUN8J5	5P	60	13	21	33	5.5	4.5	7	4	001	○	ROLL
	P3(P2+20)	3.4	3.47	TNMRUN8J1	1.5P	60	13	21	33	5.5	4.5	7	4	001	○	
No.10-24UNC	P2	3.89	3.9	TNMQUAM5	5P	60	13	22	33	5.5	4.5	7	4	001	○	
	P2	3.89	3.9	TNMQUAM1	1.5P	60	13	22	33	5.5	4.5	7	4	001	○	CARBIDE
	P3(P2+20)	3.89	3.9	TNMRUNAM5	5P	60	13	22	33	5.5	4.5	7	4	001	○	
	P3(P2+20)	3.89	3.9	TNMRUNAM1	1.5P	60	13	22	33	5.5	4.5	7	4	001	○	
No.12-24UNC	P2	4.5	4.53	TNMQUCM5	5P	62	15	26	33	6	4.5	7	4	001	○	
	P2	4.5	4.53	TNMQUCM1	1.5P	62	15	26	33	6	4.5	7	4	001	○	LONG
	P3(P2+20)	4.5	4.53	TNMRUNCM5	5P	62	15	26	33	6	4.5	7	4	001	○	
1/4-20UNC	P2	5.1	5.19	TNMQU04N5	5P	62	15	26	33	6	4.5	7	4	001	○	
	P2	5.1	5.19	TNMQU04N1	1.5P	62	15	26	33	6	4.5	7	4	001	○	HAND TAPS
	P3(P2+20)	5.1	5.19	TNMRU04N5	5P	62	15	26	33	6	4.5	7	4	001	○	
	P3(P2+20)	5.1	5.19	TNMRU04N1	1.5P	62	15	26	33	6	4.5	7	4	001	○	
	P4(P2+40)	5.1	5.19	TNMSU04N5	5P	62	15	26	33	6	4.5	7	4	001	○	
	P4(P2+40)	5.1	5.19	TNMSU04N1	1.5P	62	15	26	33	6	4.5	7	4	001	○	EG (STI)
5/16-18UNC	P3	6.6	6.65	TNMRU0505	5P	70	19	-	36	6.2	5	8	4	002	○	
	P3	6.6	6.65	TNMRU0501	1.5P	70	19	-	36	6.2	5	8	4	002	○	
	P4(P3+20)	6.6	6.65	TNMSU0505	5P	70	19	-	36	6.2	5	8	4	002	○	SPECIAL THREADS, GAUGES
	P4(P3+20)	6.6	6.65	TNMSU0501	1.5P	70	19	-	36	6.2	5	8	4	002	○	
3/8-16UNC	P3	8	8.07	TNMRU06P5	5P	75	23	-	38	7	5.5	8	4	002	○	
	P3	8	8.07	TNMRU06P1	1.5P	75	23	-	38	7	5.5	8	4	002	○	
	P4(P3+20)	8	8.07	TNMSU06P5	5P	75	23	-	38	7	5.5	8	4	002	○	THREAD MILLS
	P4(P3+20)	8	8.07	TNMSU06P1	1.5P	75	23	-	38	7	5.5	8	4	002	○	
7/16-14UNC	P3	9.4	9.45	TNMRU07Q5	5P	82	26	-	42	8.5	6.5	9	4	002	○	
	P3	9.4	9.45	TNMRU07Q1	1.5P	82	26	-	42	8.5	6.5	9	4	002	○	
	P4(P3+20)	9.4	9.45	TNMSU07Q5	5P	82	26	-	42	8.5	6.5	9	4	002	○	DIES
	P4(P3+20)	9.4	9.45	TNMSU07Q1	1.5P	82	26	-	42	8.5	6.5	9	4	002	○	
1/2-13UNC	P3	10.9	10.91	TNMRU08R5	5P	88	26	-	45	10.5	8	11	4	002	○	
	P3	10.9	10.91	TNMRU08R1	1.5P	88	26	-	45	10.5	8	11	4	002	○	CENTER DRILLS
	P4(P3+20)	10.9	10.91	TNMSU08R5	5P	88	26	-	45	10.5	8	11	4	002	○	
	P4(P3+20)	10.9	10.91	TNMSU08R1	1.5P	88	26	-	45	10.5	8	11	4	002	○	

Technical info

Straight Fluted Taps

Intro

	UNC	TCTR (tolerance)	 Hole Ø (mm)	Hole Ø (mm)	Code	THCHT (chamfer)	LF (mm)	THL (mm)	LU (mm)	LS (mm)	DCON (mm)	K (mm)	LK (mm)	NOF	Type	Stock
	JIS															
SP	9/16-12UNC	P3	12.2	12.33	TNMRU09S5	5P	95	26	-	48	12.5	10	13	4	002	○
		P3	12.2	12.33	TNMRU09S1	1.5P	95	26	-	48	12.5	10	13	4	002	○
SL	5/8-11UNC	P4	13.6	13.75	TNMSU10U5	5P	95	26	-	48	12.5	10	13	4	002	○
		P4	13.6	13.75	TNMSU10U1	1.5P	95	26	-	48	12.5	10	13	4	002	○
PO	3/4-10UNC	P4	16.6	16.7	TNMSU12V5	5P	105	33	-	50	15	12	15	4	002	○
		P4	16.6	16.7	TNMSU12V1	1.5P	105	33	-	50	15	12	15	4	002	○
ST	7/8-9UNC	P4	19.6	19.61	TNMSU14W5	5P	115	33	-	55	17	13	16	4	002	○
		P4	19.6	19.61	TNMSU14W1	1.5P	115	33	-	55	17	13	16	4	002	○
JIS	1-8UNC	P4	22.3	22.45	TNMSU16X5	5P	125	39	-	58	19	15	18	4	002	○
		P4	22.3	22.45	TNMSU16X1	1.5P	125	39	-	58	19	15	18	4	002	○
ROLL	1 1/8-7UNC	P5	25	25.17	TNMTU18Y5	5P	135	46	-	62	23	17	20	4	002	○
		P5	25	25.17	TNMTU18Y1	1.5P	135	46	-	62	23	17	20	4	002	○
CARBIDE	1 1/4-7UNC	P5	28.2	28.35	TNMTU20Y5	5P	145	46	-	67	24	19	22	4	002	○
		P5	28.2	28.35	TNMTU20Y1	1.5P	145	46	-	67	24	19	22	4	002	○
LONG	1 3/8-6UNC	P5	30.8	30.92	TNMTU22Z5	5P	155	52	-	71	28	21	24	4	002	○
		P5	30.8	30.92	TNMTU22Z1	1.5P	155	52	-	71	28	21	24	4	002	○
HAND TAPS	1 1/2-6UNC	P5	34	34.1	TNMTU24Z5	5P	165	52	-	76	30	23	26	4	002	○
		P5	34	34.1	TNMTU24Z1	1.5P	165	52	-	76	30	23	26	4	002	○
EG (STI)	1 3/4-5UNC	P6	39.5	39.61	TNMTU2805	5P	180	59	-	83	35	26	30	4	002	○
		P6	39.5	39.61	TNMTU2801	1.5P	180	59	-	83	35	26	30	4	002	○
SPECIAL THREADS, GAUGES	2-4.5UNC	II	45.2	45.37	TH2U3295	5P	195	92	-	103	40	32	35	4	002	○
		II	45.2	45.37	TH2U3291	1.5P	195	92	-	103	40	32	35	4	002	○
	JIS															
	UNF	TCTR (tolerance)	 Hole Ø (mm)	Hole Ø (mm)	Code	THCHT (chamfer)	LF (mm)	THL (mm)	LU (mm)	LS (mm)	DCON (mm)	K (mm)	LK (mm)	NOF	Type	Stock
HAND TAPS	No.0-80UNF	P1	1.25	1.27	TNMPUN0B5	5P	36	6.3	-	24	3	2.5	5	3	005	○
		P1	1.25	1.27	TNMPUN0B1	1.5P	36	6.3	-	24	3	2.5	5	3	005	○
EG (STI)	No.1-72UNF	P1	1.55	1.58	TNMPUN1C5	5P	42	7.2	-	27	3	2.5	5	3	005	○
		P1	1.55	1.58	TNMPUN1C1	1.5P	42	7.2	-	27	3	2.5	5	3	005	○
SPECIAL THREADS, GAUGES	No.2-64UNF	P1	1.85	1.87	TNMPUN2D5	5P	42	8.1	12	27	3	2.5	5	3	001	○
		P1	1.85	1.87	TNMPUN2D1	1.5P	42	8.1	12	27	3	2.5	5	3	001	○
THREAD MILLS	No.3-56UNF	P1	2.1	2.15	TNMPUN3E5	5P	46	8.1	14	29	3	2.5	5	3	001	○
		P1	2.1	2.15	TNMPUN3E1	1.5P	46	8.1	14	29	3	2.5	5	3	001	○
DIES	No.4-48UNF	P1	2.4	2.41	TNMPUN4F5	5P	46	9	14	26	4	3.2	6	3	001	○
		P1	2.4	2.41	TNMPUN4F1	1.5P	46	9	14	26	4	3.2	6	3	001	○
		P3(P1+30)	2.4	2.41	TNMRUN4F5	5P	46	9	14	26	4	3.2	6	3	001	○
		P3(P1+30)	2.4	2.41	TNMRUN4F1	1.5P	46	9	14	26	4	3.2	6	3	001	○
CENTER DRILLS	No.5-44UNF	P1	2.7	2.69	TNMPUN5G5	5P	52	11	16	29	5	4	7	3	001	○
		P1	2.7	2.69	TNMPUN5G1	1.5P	52	11	16	29	5	4	7	3	001	○
		P3(P1+30)	2.7	2.69	TNMRUN5G5	5P	52	11	16	29	5	4	7	3	001	○
		P3(P1+30)	2.7	2.69	TNMRUN5G1	1.5P	52	11	16	29	5	4	7	3	001	○
DIES	No.6-40UNF	P2	2.9	2.97	TNMQUN6H5	5P	52	11	16	29	5	4	7	3	001	○
		P2	2.9	2.97	TNMQUN6H1	1.5P	52	11	16	29	5	4	7	3	001	○
		P3(P2+15)	2.9	2.97	TNMRUN6H5	5P	52	11	16	29	5	4	7	3	001	○
		P3(P2+15)	2.9	2.97	TNMRUN6H1	1.5P	52	11	16	29	5	4	7	3	001	○

Technical info

UNF	TCTR (tolerance)	\varnothing (mm)	Hole \varnothing (mm)	Code	THCHT (chamfer)	LF (mm)	THL (mm)	LU (mm)	LS (mm)	DCON (mm)	K (mm)	LK (mm)	NOF	Type	Stock	Intro
JIS																
No.8-36UNF	P2	3.5	3.55	TNMQU8I5	5P	60	13	21	33	5.5	4.5	7	4	001	○	
	P2	3.5	3.55	TNMQU8I1	1.5P	60	13	21	33	5.5	4.5	7	4	001	○	SP
	P3(P2+20)	3.5	3.55	TNMRU8I5	5P	60	13	21	33	5.5	4.5	7	4	001	○	
	P3(P2+20)	3.5	3.55	TNMRU8I1	1.5P	60	13	21	33	5.5	4.5	7	4	001	○	
No.10-32UNF	P2	4.1	4.12	TNMQUAJ5	5P	60	13	22	33	5.5	4.5	7	4	001	○	
	P2	4.1	4.12	TNMQUAJ1	1.5P	60	13	22	33	5.5	4.5	7	4	001	○	SL
	P3(P2+20)	4.1	4.12	TNMRUNAJ5	5P	60	13	22	33	5.5	4.5	7	4	001	○	
	P3(P2+20)	4.1	4.12	TNMRUNAJ1	1.5P	60	13	22	33	5.5	4.5	7	4	001	○	
No.12-28UNF	P2	4.6	4.67	TNMQUCK5	5P	62	15	26	33	6	4.5	7	4	001	○	
	P2	4.6	4.67	TNMQUCK1	1.5P	62	15	26	33	6	4.5	7	4	001	○	PO
	P3(P2+20)	4.6	4.67	TNMRUNCK5	5P	62	15	26	33	6	4.5	7	4	001	○	
	P3(P2+20)	4.6	4.67	TNMRUNCK1	1.5P	62	15	26	33	6	4.5	7	4	001	○	
1/4-28UNF	P2	5.5	5.53	TNMQU04K5	5P	62	15	26	33	6	4.5	7	4	001	○	ST
	P2	5.5	5.53	TNMQU04K1	1.5P	62	15	26	33	6	4.5	7	4	001	○	JIS
	P4(P2+40)	5.5	5.53	TNMSU04K5	5P	62	15	26	33	6	4.5	7	4	001	○	
	P4(P2+40)	5.5	5.53	TNMSU04K1	1.5P	62	15	26	33	6	4.5	7	4	001	○	
5/16-24UNF	P2	6.9	6.97	TNMQU05M5	5P	70	19	-	36	6.2	5	8	4	002	○	
	P2	6.9	6.97	TNMQU05M1	1.5P	70	19	-	36	6.2	5	8	4	002	○	ROLL
	P4(P2+40)	6.9	6.97	TNMSU05M5	5P	70	19	-	36	6.2	5	8	4	002	○	
	P4(P2+40)	6.9	6.97	TNMSU05M1	1.5P	70	19	-	36	6.2	5	8	4	002	○	CARBIDE
3/8-24UNF	P3	8.5	8.57	TNMRU06M5	5P	75	23	-	38	7	5.5	8	4	002	○	
	P3	8.5	8.57	TNMRU06M1	1.5P	75	23	-	38	7	5.5	8	4	002	○	
	P4(P3+20)	8.5	8.57	TNMSU06M5	5P	75	23	-	38	7	5.5	8	4	002	○	LONG
	P4(P3+20)	8.5	8.57	TNMSU06M1	1.5P	75	23	-	38	7	5.5	8	4	002	○	
7/16-20UNF	P3	9.9	9.96	TNMRU07N5	5P	82	26	-	42	8.5	6.5	9	4	002	○	
	P3	9.9	9.96	TNMRU07N1	1.5P	82	26	-	42	8.5	6.5	9	4	002	○	
	P4(P3+20)	9.9	9.96	TNMSU07N5	5P	82	26	-	42	8.5	6.5	9	4	002	○	HAND TAPS
	P4(P3+20)	9.9	9.96	TNMSU07N1	1.5P	82	26	-	42	8.5	6.5	9	4	002	○	
1/2-20UNF	P3	11.5	11.54	TNMRU08N5	5P	88	26	-	45	10.5	8	11	4	002	○	
	P3	11.5	11.54	TNMRU08N1	1.5P	88	26	-	45	10.5	8	11	4	002	○	
	P4(P3+20)	11.5	11.54	TNMSU08N5	5P	88	26	-	45	10.5	8	11	4	002	○	EG (STI)
	P4(P3+20)	11.5	11.54	TNMSU08N1	1.5P	88	26	-	45	10.5	8	11	4	002	○	
9/16-18UNF	P3	12.9	13	TNMRU09O5	5P	95	26	-	48	12.5	10	13	4	002	○	
	P3	12.9	13	TNMRU09O1	1.5P	95	26	-	48	12.5	10	13	4	002	○	SPECIAL THREADS, GAUGES
	P4(P3+20)	12.9	13	TNMSU09O5	5P	95	26	-	48	12.5	10	13	4	002	○	
	P4(P3+20)	12.9	13	TNMSU09O1	1.5P	95	26	-	48	12.5	10	13	4	002	○	
5/8-18UNF	P3	14.5	14.6	TNMRU10O5	5P	95	26	-	48	12.5	10	13	4	002	○	
	P3	14.5	14.6	TNMRU10O1	1.5P	95	26	-	48	12.5	10	13	4	002	○	THREAD MILLS
	P4(P3+20)	14.5	14.6	TNMSU10O5	5P	95	26	-	48	12.5	10	13	4	002	○	
	P4(P3+20)	14.5	14.6	TNMSU10O1	1.5P	95	26	-	48	12.5	10	13	4	002	○	
3/4-16UNF	P3	17.5	17.59	TNMRU12P5	5P	105	33	-	50	15	12	15	4	002	○	
	P3	17.5	17.59	TNMRU12P1	1.5P	105	33	-	50	15	12	15	4	002	○	DIES
	P4(P3+20)	17.5	17.59	TNMSU12P5	5P	105	33	-	50	15	12	15	4	002	○	
	P4(P3+20)	17.5	17.59	TNMSU12P1	1.5P	105	33	-	50	15	12	15	4	002	○	
7/8-14UNF	P4	20.5	20.57	TNMSU14Q5	5P	115	33	-	55	17	13	16	4	002	○	CENTER DRILLS
	P4	20.5	20.57	TNMSU14Q1	1.5P	115	33	-	55	17	13	16	4	002	○	

Straight Fluted Taps

Intro

	UNF	TCTR (tolerance)	\varnothing (mm)	Hole \varnothing (mm)	Code	THCHT (chamfer)	LF (mm)	THL (mm)	LU (mm)	LS (mm)	DCON (mm)	K (mm)	LK (mm)	NOF	Type	Stock
	JIS															
SP	1 -12UNF	P4	23.3	23.46	TNMSU16S5	5P	125	39	-	58	19	15	18	4	002	○
		P4	23.3	23.46	TNMSU16S1	1.5P	125	39	-	58	19	15	18	4	002	○
SL	1 1/8-12UNF	P4	26.5	26.63	TNMSU18S5	5P	135	46	-	62	23	17	20	4	002	○
		P4	26.5	26.63	TNMSU18S1	1.5P	135	46	-	62	23	17	20	4	002	○
PO	1 1/4-12UNF	P4	29.6	29.81	TNMSU20S5	5P	145	46	-	67	24	19	22	4	002	○
		P4	29.6	29.81	TNMSU20S1	1.5P	145	46	-	67	24	19	22	4	002	○
PO	1 3/8-12UNF	P4	32.8	32.98	TNMSU22S5	5P	155	52	-	71	28	21	24	4	002	○
		P4	32.8	32.98	TNMSU22S1	1.5P	155	52	-	71	28	21	24	4	002	○
PO	1 1/2-12UNF	P4	36	36.16	TNMSU24S5	5P	165	52	-	76	30	23	26	4	002	○
		P4	36	36.16	TNMSU24S1	1.5P	165	52	-	76	30	23	26	4	002	○

ST

	UNS	TCTR (tolerance)	\varnothing (mm)	Hole \varnothing (mm)	Code	THCHT (chamfer)	LF (mm)	THL (mm)	LU (mm)	LS (mm)	DCON (mm)	K (mm)	LK (mm)	NOF	Type	Stock
	JIS															
JIS	7/16-24UNS	P3	10.1	10.16	TNMRU07M5	5P	82	26	-	42	8.5	6.5	9	4	002	○
		P3	10.1	10.16	TNMRU07M1	1.5P	82	26	-	42	8.5	6.5	9	4	002	○
ROLL	1/2-24UNS	P3	11.65	11.75	TNMRU08M5	5P	88	26	-	45	10.5	8	11	4	002	○
		P3	11.65	11.75	TNMRU08M1	1.5P	88	26	-	45	10.5	8	11	4	002	○
CARBIDE	1 -14UNS	P4	23.6	23.7	TNMSU16Q5	5P	125	39	-	58	19	15	18	4	002	○
		P4	23.6	23.7	TNMSU16Q1	1.5P	125	39	-	58	19	15	18	4	002	○
LONG	1 1/16-14UNS	P4	25.2	25.3	TNMSU17Q5	5P	130	39	-	60	20	15	18	4	002	○
		P4	25.2	25.3	TNMSU17Q1	1.5P	130	39	-	60	20	15	18	4	002	○
LONG	1 5/8-5UNS	P5	36.2	36.4	TNMTU2605	5P	175	59	-	81	32	26	30	4	002	○
		P5	36.2	36.4	TNMTU2601	1.5P	175	59	-	81	32	26	30	4	002	○
	8UN															
	JIS															

HAND TAPS

HAND TAPS	1 1/8-8UN	P5	25.5	25.62	TNMTU18X5	5P	135	46	-	62	23	17	20	4	002	○
		P5	25.5	25.62	TNMTU18X1	1.5P	135	46	-	62	23	17	20	4	002	○
EG (STI)	1 1/4-8UN	P5	28.5	28.8	TNMTU20X5	5P	145	46	-	67	24	19	22	4	002	○
		P5	28.5	28.8	TNMTU20X1	1.5P	145	46	-	67	24	19	22	4	002	○
SPECIAL THREADS, GAUGES	1 3/8-8UN	P5	31.8	31.97	TNMTU22X5	5P	155	52	-	71	28	21	24	4	002	○
		P5	31.8	31.97	TNMTU22X1	1.5P	155	52	-	71	28	21	24	4	002	○
THREAD MILLS	1 1/2-8UN	P5	35	35.15	TNMTU24X5	5P	165	52	-	76	30	23	26	4	002	○
		P5	35	35.15	TNMTU24X1	1.5P	165	52	-	76	30	23	26	4	002	○
DIES	1 5/8-8UN	P5	38.1	38.32	TNMTU26X5	5P	175	59	-	81	32	26	30	4	002	○
		P5	38.1	38.32	TNMTU26X1	1.5P	175	59	-	81	32	26	30	4	002	○
DIES	1 3/4-8UN	P5	41.3	41.5	TNMTU28X5	5P	180	59	-	83	35	26	30	4	002	○
		P5	41.3	41.5	TNMTU28X1	1.5P	180	59	-	83	35	26	30	4	002	○
DIES	1 7/8-8UN	P5	44.5	44.7	TNMTU30X5	5P	185	65	-	85	38	29	32	4	002	○
		P5	44.5	44.7	TNMTU30X1	1.5P	185	65	-	85	38	29	32	4	002	○
DIES	2 -8UN	II	47.8	47.85	TH2U32X5	5P	180	80	-	100	40	32	35	4	002	○
		II	47.8	47.85	TH2U32X1	1.5P	180	80	-	100	40	32	35	4	002	○
DIES	2 1/4-8UN	II	54	54.2	TH2U36X5	5P	180	80	-	100	44	35	38	4	002	○
		II	54	54.2	TH2U36X1	1.5P	180	80	-	100	44	35	38	4	002	○
CENTER DRILLS	2 1/2-8UN	II	60.5	60.6	TH2U40X5	5P	185	85	-	100	48	38	42	4	002	○
		II	60.5	60.6	TH2U40X1	1.5P	185	85	-	100	48	38	42	4	002	○

Technical info

8UN	TCTR (tolerance)	 Hole Ø (mm)	Hole Ø (mm)	Code	THCHT (chamfer)	LF (mm)	THL (mm)	LU (mm)	LS (mm)	DCON (mm)	K (mm)	LK (mm)	NOF	Type	Stock
JIS															
2 3/4-8UN	II	67	67.1	TH2U44X5	5P	190	85	-	105	55	41	44	4	002	○
	II	67	67.1	TH2U44X1	1.5P	190	85	-	105	55	41	44	4	002	○
3-8UN	II	73	73.3	TH2U48X5	5P	190	85	-	105	58	46	50	4	002	○
	II	73	73.3	TH2U48X1	1.5P	190	85	-	105	58	46	50	4	002	○
JIS															
1 1/16-12UN	P4	24.9	25	TNMSU17S5	5P	130	39	-	60	20	15	18	4	002	○
	P4	24.9	25	TNMSU17S1	1.5P	130	39	-	60	20	15	18	4	002	○
1 3/16-12UN	P4	28	28.2	TNMSU19S5	5P	145	46	-	67	24	19	22	4	002	○
	P4	28	28.2	TNMSU19S1	1.5P	145	46	-	67	24	19	22	4	002	○
1 5/16-12UN	P4	31.2	31.4	TNMSU21S5	5P	155	52	-	71	28	21	24	4	002	○
	P4	31.2	31.4	TNMSU21S1	1.5P	155	52	-	71	28	21	24	4	002	○
1 5/8-12UN	P4	39.1	39.33	TNMSU26S5	5P	175	59	-	81	32	26	30	4	002	○
	P4	39.1	39.33	TNMSU26S1	1.5P	175	59	-	81	32	26	30	4	002	○
1 3/4-12UN	P4	42.3	42.51	TNMSU28S5	5P	180	59	-	83	35	26	30	4	002	○
	P4	42.3	42.51	TNMSU28S1	1.5P	180	59	-	83	35	26	30	4	002	○
1 7/8-12UN	P4	45.5	45.7	TNMSU30S5	5P	185	65	-	85	38	29	32	4	002	○
	P4	45.5	45.7	TNMSU30S1	1.5P	185	65	-	85	38	29	32	4	002	○
2-12UN	II	48.6	48.86	TH2U32S5	5P	130	45	-	85	40	32	35	4	002	○
	II	48.6	48.86	TH2U32S1	1.5P	130	45	-	85	40	32	35	4	002	○
JIS															
9/16-20UN	P3	12.9	13	TNMRU09N5	5P	95	26	-	48	12.5	10	13	4	002	○
	P3	12.9	13	TNMRU09N1	1.5P	95	26	-	48	12.5	10	13	4	002	○
5/8-20UN	P3	14.7	14.71	TNMRU10N5	5P	95	26	-	48	12.5	10	13	4	002	○
	P3	14.7	14.71	TNMRU10N1	1.5P	95	26	-	48	12.5	10	13	4	002	○
JIS															
1/2-32UN	P2	11.9	11.99	TNMQU08J5	5P	88	14	-	45	10.5	8	11	4	037	○
	P2	11.9	11.99	TNMQU08J1	1.5P	88	14	-	45	10.5	8	11	4	037	○
JIS															
No.12-32UNEF	P2	4.7	4.78	TNMQU08J5	5P	62	15	26	33	6	4.5	7	4	001	○
	P2	4.7	4.78	TNMQU08J1	1.5P	62	15	26	33	6	4.5	7	4	001	●
1/4-32UNEF	P2	5.6	5.64	TNMQU04J5	5P	62	15	26	33	6	4.5	7	4	001	○
	P2	5.6	5.64	TNMQU04J1	1.5P	62	15	26	33	6	4.5	7	4	001	●
5/16-32UNEF	P2	7.1	7.22	TNMQU05J5	5P	70	19	-	36	6.2	5	8	4	002	○
	P2	7.1	7.22	TNMQU05J1	1.5P	70	19	-	36	6.2	5	8	4	002	●
3/8-32UNEF	P2	8.7	8.81	TNMQU06J5	5P	75	13	-	38	7	5.5	8	4	037	○
	P2	8.7	8.81	TNMQU06J1	1.5P	75	13	-	38	7	5.5	8	4	037	●
7/16-28UNEF	P2	10.2	10.29	TNMQU07K5	5P	82	26	-	42	8.5	6.5	9	4	002	●
	P2	10.2	10.29	TNMQU07K1	1.5P	82	26	-	42	8.5	6.5	9	4	002	○

Intro

SP

SL

PO

ST

JIS

ROLL

CARBIDE

LONG

HAND TAPS

EG (STI)

SPECIAL THREADS, GAUGES

THREAD MILLS

DIES

CENTER DRILLS

Technical info

Straight Fluted Taps

Intro

SP

SL

PO

ST

JIS

ROLL

CARBIDE

LONG

HAND TAPS

EG (STI)

SPECIAL THREADS, GAUGES

THREAD MILLS

DIES

CENTER DRILLS

Technical info

UNE F	TCTR (tolerance)	\varnothing (mm)	Hole \varnothing (mm)	Code	THCHT (chamfer)	LF (mm)	THL (mm)	LU (mm)	LS (mm)	D CON (mm)	K (mm)	LK (mm)	NOF	Type	Stock
JIS															
1/2-28UNE F	P2	11.8	11.88	TNMQU08K5	5P	88	26	-	45	10.5	8	11	4	002	○
	P2	11.8	11.88	TNMQU08K1	1.5P	88	26	-	45	10.5	8	11	4	002	●
9/16-24UNE F	P3	13.2	13.32	TNMRU09M5	5P	95	26	-	48	12.5	10	13	4	002	○
	P3	13.2	13.32	TNMRU09M1	1.5P	95	26	-	48	12.5	10	13	4	002	●
5/8-24UNE F	P3	14.8	14.92	TNMRU10M5	5P	95	26	-	48	12.5	10	13	4	002	○
	P3	14.8	14.92	TNMRU10M1	1.5P	95	26	-	48	12.5	10	13	4	002	●
3/4-20UNE F	P3	17.8	17.89	TNMRU12N5	5P	105	33	-	50	15	12	15	4	002	●
	P3	17.8	17.89	TNMRU12N1	1.5P	105	33	-	50	15	12	15	4	002	○
7/8-20UNE F	P3	21	21.06	TNMRU14N5	5P	115	33	-	55	17	13	16	4	002	○
	P3	21	21.06	TNMRU14N1	1.5P	115	33	-	55	17	13	16	4	002	●
1-20UNE F	P3	24.1	24.24	TNMRU16N5	5P	125	39	-	58	19	15	18	4	002	○
	P3	24.1	24.24	TNMRU16N1	1.5P	125	39	-	58	19	15	18	4	002	●
BSW															
TCTR (tolerance)															
\varnothing (mm)															
Hole \varnothing (mm)															
Code															
THCHT (chamfer)															
LF (mm)															
THL (mm)															
LU (mm)															
LS (mm)															
D CON (mm)															
K (mm)															
LK (mm)															
NOF															
Type															
Stock															
JIS															
1/16W60	P2	1.15	1.2	TNMQW01-5	5P	36	6.3	-	24	3	2.5	5	3	005	○
	P2	1.15	1.2	TNMQW01-1	1.5P	36	6.3	-	24	3	2.5	5	3	005	○
3/32W48	P2	1.85	1.88	TNMQW1HF5	5P	46	8.1	14	29	3	2.5	5	3	001	○
	P2	1.85	1.88	TNMQW1HF1	1.5P	46	8.1	14	29	3	2.5	5	3	001	○
1/8W40	P2	2.55	2.56	TNMQW02H5	5P	52	11	16	28	5	4	7	3	001	○
	P2	2.55	2.56	TNMQW02H1	1.5P	52	11	16	28	5	4	7	3	001	●
5/32W32	P2	3.15	3.2	TNMQW2HJ5	5P	52	11	17	29	5	4	7	4	001	○
	P2	3.15	3.2	TNMQW2HJ1	1.5P	52	11	17	29	5	4	7	4	001	●
3/16W24	P3	3.7	3.7	TNMRW03M5	5P	60	13	21	33	5.5	4.5	7	4	001	○
	P3	3.7	3.7	TNMRW03M1	1.5P	60	13	21	33	5.5	4.5	7	4	001	●
7/32W24	P3	4.5	4.52	TNMRW3HM5	5P	62	15	26	33	6	4.5	7	4	001	○
	P3	4.5	4.52	TNMRW3HM1	1.5P	62	15	26	33	6	4.5	7	4	001	●
1/4W20	P3	5.1	5.13	TNMRW04N5	5P	62	15	26	33	6	4.5	7	4	001	○
	P3	5.1	5.13	TNMRW04N1	1.5P	62	15	26	33	6	4.5	7	4	001	●
5/16W18	P3	6.5	6.59	TNMRW0505T	5P	70	19	-	36	6.2	5	8	3	002	○
	P3	6.5	6.59	TNMRW0501T	1.5P	70	19	-	36	6.2	5	8	3	002	○
	P3	6.5	6.59	TNMRW0505	5P	70	19	-	36	6.2	5	8	4	002	○
	P3	6.5	6.59	TNMRW0501	1.5P	70	19	-	36	6.2	5	8	4	002	●
3/8W16	P3	8	8.02	TNMRW06P5	5P	75	23	-	38	7	5.5	8	4	002	○
	P3	8	8.02	TNMRW06P1	1.5P	75	23	-	38	7	5.5	8	4	002	●
7/16W14	P4	9.3	9.39	TNMSW07Q5	5P	82	26	-	42	8.5	6.5	9	4	002	○
	P4	9.3	9.39	TNMSW07Q1	1.5P	82	26	-	42	8.5	6.5	9	4	002	●
1/2W12	P4	10.6	10.7	TNMSW08S5	5P	88	26	-	45	10.5	8	11	4	002	○
	P4	10.6	10.7	TNMSW08S1	1.5P	88	26	-	45	10.5	8	11	4	002	●
9/16W12	P4	12.25	12.29	TNMSW09S5	5P	95	26	-	48	12.5	10	13	4	002	○
	P4	12.25	12.29	TNMSW09S1	1.5P	95	26	-	48	12.5	10	13	4	002	●
5/8W11	P4	13.5	13.68	TNMSW10U5	5P	95	26	-	48	12.5	10	13	4	002	○
	P4	13.5	13.68	TNMSW10U1	1.5P	95	26	-	48	12.5	10	13	4	002	●
3/4W10	P4	16.5	16.63	TNMSW12V5	5P	105	33	-	50	15	12	15	4	002	○
	P4	16.5	16.63	TNMSW12V1	1.5P	105	33	-	50	15	12	15	4	002	●
7/8W9	P5	19.5	19.53	TNMTW14W5	5P	115	33	-	55	17	13	16	4	002	○
	P5	19.5	19.53	TNMTW14W1	1.5P	115	33	-	55	17	13	16	4	002	●

BSW	TCTR (tolerance)	∅ (mm)	Hole ∅ (mm)	Code	THCHT (chamfer)	LF (mm)	THL (mm)	LU (mm)	LS (mm)	DCON (mm)	K (mm)	LK (mm)	NOF	Type	Stock
JIS															
1 W8	P5	22.2	22.34	TNMTW16X5	5P	125	39	-	58	19	15	18	4	002	○
	P5	22.2	22.34	TNMTW16X1	1.5P	125	39	-	58	19	15	18	4	002	●
1 1/8W7	P5	24.75	25.04	TNMTW18Y5	5P	135	46	-	62	23	17	20	4	002	○
	P5	24.75	25.04	TNMTW18Y1	1.5P	135	46	-	62	23	17	20	4	002	○
1 1/4W7	P5	28	28.21	TNMTW20Y5	5P	145	46	-	67	24	19	22	4	002	○
	P5	28	28.21	TNMTW20Y1	1.5P	145	46	-	67	24	19	22	4	002	○
1 3/8W6	P6	30.5	30.72	TNMUW22Z5	5P	155	52	-	71	28	21	24	4	002	○
	P6	30.5	30.72	TNMUW22Z1	1.5P	155	52	-	71	28	21	24	4	002	○
1 1/2W6	P6	33.75	33.9	TNMUW24Z5	5P	165	52	-	76	30	23	26	4	002	○
	P6	33.75	33.9	TNMUW24Z1	1.5P	165	52	-	76	30	23	26	4	002	○
1 5/8W5	P6	36	36.19	TNMUW26O5	5P	175	59	-	81	32	26	30	4	002	○
	P6	36	36.19	TNMUW26O1	1.5P	175	59	-	81	32	26	30	4	002	○
1 3/4W5	P6	39.2	39.36	TNMUW28O5	5P	180	59	-	83	35	26	30	4	002	○
	P6	39.2	39.36	TNMUW28O1	1.5P	180	59	-	83	35	26	30	4	002	○
1 7/8W4 1/2	P6	41.8	42	TNMUW3095	5P	185	65	-	85	38	29	32	4	002	○
	P6	41.8	42	TNMUW3091	1.5P	185	65	-	85	38	29	32	4	002	○
2 W4 1/2	II	45	45.15	TH2W3295	5P	195	92	-	103	40	32	35	4	002	○
	II	45	45.15	TH2W3291	1.5P	195	92	-	103	40	32	35	4	002	○
2 1/4W4	II	50.5	50.79	TH2W3685	5P	210	100	-	110	44	35	38	4	002	○
	II	50.5	50.79	TH2W3681	1.5P	210	100	-	110	44	35	38	4	002	○
2 1/2W4	II	57	57.14	TH2W4085	5P	225	105	-	120	48	38	42	4	002	○
	II	57	57.14	TH2W4081	1.5P	225	105	-	120	48	38	42	4	002	○
2 3/4W3 1/2	II	62.5	62.52	TH2W4475	5P	240	115	-	125	55	41	44	4	002	○
	II	62.5	62.52	TH2W4471	1.5P	240	115	-	125	55	41	44	4	002	○
3 W3 1/2	II	68.5	68.87	TH2W4875	5P	250	120	-	130	58	46	50	4	002	○
	II	68.5	68.87	TH2W4871	1.5P	250	120	-	130	58	46	50	4	002	○
3 1/4W3 1/4	II	74.5	74.6	TH2W52-5	5P	265	125	-	140	58	46	50	6	002	○
	II	74.5	74.6	TH2W52-1	1.5P	265	125	-	140	58	46	50	6	002	○
3 1/2W3 1/4	II	81	81.1	TH2W56-5	5P	275	130	-	145	60	46	50	6	002	○
	II	81	81.1	TH2W56-1	1.5P	275	130	-	145	60	46	50	6	002	○
3 3/4W3	II	86.5	86.6	TH2W6065	5P	285	135	-	150	65	50	52	6	002	○
	II	86.5	86.6	TH2W6061	1.5P	285	135	-	150	65	50	52	6	002	○
4 W3	II	92.8	92.95	TH2W6465	5P	295	135	-	160	65	50	52	6	002	○
	II	92.8	92.95	TH2W6461	1.5P	295	135	-	160	65	50	52	6	002	○

Intro

SP

SL

PO

ST
JIS

ROLL

CARBIDE

LONG

HAND TAPS

EG (STI)

SPECIAL THREADS, GAUGES

THREAD MILLS

DIES

CENTER DRILLS

Technical info

Intro

HT LH

GP General Purpose Series

Straight Fluted Taps for Left Hand Threads



SP

SL



FEATURES

General purpose for blind and through hole application.
For steel application at low cutting speed, also suitable for cast iron and non-ferrous materials.
For left hand threads.

PO

Recommended Tapping Speeds Depending On Materials

ISO	Vc (m/min)	ISO	Vc (m/min)	ISO	Vc (m/min)
P1	5÷10 ☆	K1	5÷10 ☆	N2	5÷10 ☆
P2	5÷10 ★	K2	5÷10 ☆	N3	5÷10 ☆
P3	5÷10 ☆	K3	5÷10 ☆	N4	5÷10 ☆
P4	5÷10 ☆				

★ 1st choice ☆ suitable

ST

JIS

ROLL

CARBIDE

LONG

HAND TAPS

EG (STI)

SPECIAL THREADS, GAUGES

THREAD MILLS

DIES

CENTER DRILLS

Technical info

TYPE: HT_005

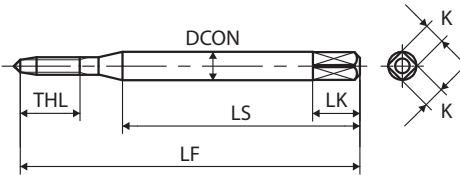

TYPE: HT_001

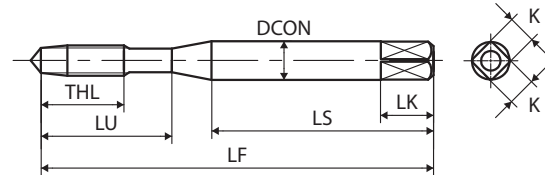

TYPE: HT_002

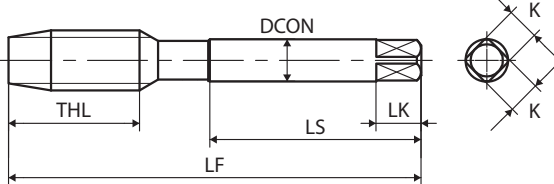

TYPE: HT_037

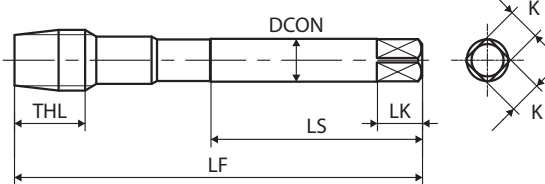

TYPE: HT_025

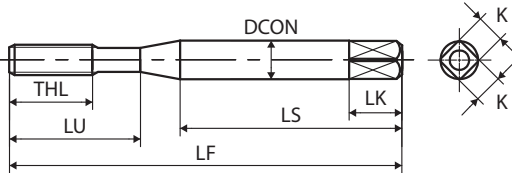

M	TCTR (tolerance)	∅ (mm)	Hole ∅ (mm)	Code	THCHT (chamfer)	LF (mm)	THL (mm)	LU (mm)	LS (mm)	DCON (mm)	K (mm)	LK (mm)	NOF	Type	Stock
JIS															
M1X0.25	P1	0.75	0.77	TNMP1.0B5-L	5P	36	4.5	-	24	3	2.5	5	3	005	○
	P1	0.75	0.77	TNMP1.0B1-L	1.5P	36	4.5	-	24	3	2.5	5	3	005	○
M1.2X0.25	P1	0.95	0.97	TNMP1.2B5-L	5P	36	4.5	-	24	3	2.5	5	3	005	○
	P1	0.95	0.97	TNMP1.2B1-L	1.5P	36	4.5	-	24	3	2.5	5	3	005	○
M1.4X0.3	P1	1.1	1.13	TNMP1.4C5-L	5P	36	5.4	-	24	3	2.5	5	3	005	○
	P1	1.1	1.13	TNMP1.4C1-L	1.5P	36	5.4	-	24	3	2.5	5	3	005	○
M1.6X0.35	P2	1.25	1.3	TNMQ1.6D5-L	5P	36	6.3	-	24	3	2.5	5	3	005	○
	P2	1.25	1.3	TNMQ1.6D1-L	1.5P	36	6.3	-	24	3	2.5	5	3	005	○
M1.7X0.35	P1	1.35	1.4	TNMP1.7D5-L	5P	36	6.3	-	24	3	2.5	5	3	005	○
	P1	1.35	1.4	TNMP1.7D1-L	1.5P	36	6.3	-	24	3	2.5	5	3	005	○
M2X0.4	P1	1.6	1.65	TNMP2.0E5-L	5P	42	7.2	12	27	3	2.5	5	3	001	○
	P1	1.6	1.65	TNMP2.0E1-L	1.5P	42	7.2	12	27	3	2.5	5	3	001	●
M2.3X0.4	P1	1.9	1.95	TNMP2.3E5-L	5P	42	7.2	12	27	3	2.5	5	3	001	○
	P1	1.9	1.95	TNMP2.3E1-L	1.5P	42	7.2	12	27	3	2.5	5	3	001	○
M2.5X0.45	P2	2.1	2.11	TNMQ2.5F5-L	5P	46	8.1	14	29	3	2.5	5	3	001	○
	P2	2.1	2.11	TNMQ2.5F1-L	1.5P	46	8.1	14	29	3	2.5	5	3	001	●
M2.6X0.45	P1	2.2	2.21	TNMP2.6F5-L	5P	46	8.1	14	29	3	2.5	5	3	001	○
	P1	2.2	2.21	TNMP2.6F1-L	1.5P	46	8.1	14	29	3	2.5	5	3	001	●
3M0.6	P2	2.45	2.47	TNMQ3.0H5-L	5P	46	9	14	26	4	3.2	6	3	001	○
	P2	2.45	2.47	TNMQ3.0H1-L	1.5P	46	9	14	26	4	3.2	6	3	001	○
M3X0.5	P2	2.5	2.56	TNMQ3.0G5-L	5P	46	9	14	26	4	3.2	6	3	001	○
	P2	2.5	2.56	TNMQ3.0G1-L	1.5P	46	9	14	26	4	3.2	6	3	001	●
M3.5X0.6	P2	2.9	2.97	TNMQ3.5H5-L	5P	52	11	16	29	5	4	7	3	001	○
	P2	2.9	2.97	TNMQ3.5H1-L	1.5P	52	11	16	29	5	4	7	3	001	●
4M0.75	P2	3.3	3.33	TNMQ4.0J5-L	5P	52	11	17	29	5	4	7	4	001	○
	P2	3.3	3.33	TNMQ4.0J1-L	1.5P	52	11	17	29	5	4	7	4	001	○
	P2	3.3	3.33	TNMQ4.0J53-L	5P	52	11	17	29	5	4	7	3	001	○
	P2	3.3	3.33	TNMQ4.0J13-L	1.5P	52	11	17	29	5	4	7	3	001	○
M4X0.7	P2	3.3	3.38	TNMQ4.0I5-L	5P	52	11	17	29	5	4	7	4	001	○
	P2	3.3	3.38	TNMQ4.0I1-L	1.5P	52	11	17	29	5	4	7	4	001	●
	P2	3.3	3.38	TNMQ4.0I53-L	5P	52	11	17	29	5	4	7	3	001	○
	P2	3.3	3.38	TNMQ4.0I13-L	1.5P	52	11	17	29	5	4	7	3	001	○
5M0.9	P2	4.15	4.19	TNMQ5.0L5-L	5P	60	13	22	33	5.5	4.5	7	4	001	○
	P2	4.15	4.19	TNMQ5.0L1-L	1.5P	60	13	22	33	5.5	4.5	7	4	001	○
	P2	4.15	4.19	TNMQ5.0L53-L	5P	60	13	22	33	5.5	4.5	7	3	001	○
	P2	4.15	4.19	TNMQ5.0L13-L	1.5P	60	13	22	33	5.5	4.5	7	3	001	○
M5X0.8	P3	4.2	4.28	TNMR5.0K5-L	5P	60	13	22	33	5.5	4.5	7	4	001	○
	P3	4.2	4.28	TNMR5.0K1-L	1.5P	60	13	22	33	5.5	4.5	7	4	001	●
	P3	4.2	4.28	TNMR5.0K53-L	5P	60	13	22	33	5.5	4.5	7	3	001	○
	P3	4.2	4.28	TNMR5.0K13-L	1.5P	60	13	22	33	5.5	4.5	7	3	001	○
M6X1	P2	5	5.09	TNMQ6.0M5-L	5P	62	15	26	33	6	4.5	7	4	001	○
	P2	5	5.09	TNMQ6.0M1-L	1.5P	62	15	26	33	6	4.5	7	4	001	●
	P2	5	5.09	TNMQ6.0M53-L	5P	62	15	26	33	6	4.5	7	3	001	○
	P2	5	5.09	TNMQ6.0M13-L	1.5P	62	15	26	33	6	4.5	7	3	001	○
	P2	5	5.09	TNMQ6.0M13FL	1.5P	62	15	26	33	6	4.5	7	3	025	○

Intro

SP

SL

PO

ST
JIS

ROLL

CARBIDE

LONG

HAND TAPS

EG (STI)

SPECIAL THREADS, GAUGES

THREAD MILLS



DIES

CENTER DRILLS

Technical info

Straight Fluted Taps

Intro

	M	TCTR (tolerance)	 Hole Ø (mm)	Hole Ø (mm)	Code	THCHT (chamfer)	LF (mm)	THL (mm)	LU (mm)	LS (mm)	DCON (mm)	K (mm)	LK (mm)	NOF	Type	Stock
	JIS															
SP	M7X1	P2	6	6.09	TNMQ7.0M5-L	5P	70	19	-	36	6.2	5	8	4	002	○
		P2	6	6.09	TNMQ7.0M1-L	1.5P	70	19	-	36	6.2	5	8	4	002	○
SL	M8X1.25	P3	6.8	6.85	TNMR8.0N5-L	5P	70	19	-	36	6.2	5	8	4	002	○
		P3	6.8	6.85	TNMR8.0N1-L	1.5P	70	19	-	36	6.2	5	8	4	002	●
		P3	6.8	6.85	TNMR8.0N5TL	5P	70	19	-	36	6.2	5	8	3	002	○
PO	M9X1.25	P3	7.8	7.85	TNMR9.0N5-L	5P	75	23	-	38	7	5.5	8	4	002	○
		P3	7.8	7.85	TNMR9.0N1-L	1.5P	75	23	-	38	7	5.5	8	4	002	○
ST	M10X1.5	P3	8.5	8.6	TNMR01005-L	5P	75	23	-	38	7	5.5	8	4	002	○
		P3	8.5	8.6	TNMR01001-L	1.5P	75	23	-	38	7	5.5	8	4	002	●
JIS	M11X1.5	P4	9.5	9.6	TNMS01105-L	5P	82	26	-	42	8.5	6.5	9	4	002	○
		P4	9.5	9.6	TNMS01101-L	1.5P	82	26	-	42	8.5	6.5	9	4	002	○
ROLL	M12X1.75	P3	10.3	10.36	TNMR012P5-L	5P	82	26	-	42	8.5	6.5	9	4	002	○
		P3	10.3	10.36	TNMR012P1-L	1.5P	82	26	-	42	8.5	6.5	9	4	002	●
CARBIDE	M14X2	P3	12	12.12	TNMR014Q5-L	5P	88	26	-	45	10.5	8	11	4	002	○
		P3	12	12.12	TNMR014Q1-L	1.5P	88	26	-	45	10.5	8	11	4	002	●
		P3	14	14.12	TNMR016Q5-L	5P	95	26	-	48	12.5	10	13	4	002	○
LONG	M16X2	P3	14	14.12	TNMR016Q1-L	1.5P	95	26	-	48	12.5	10	13	4	002	●
		P4	15.5	15.63	TNMS018R5-L	5P	100	33	-	51	14	11	14	4	002	○
		P4	15.5	15.63	TNMS018R1-L	1.5P	100	33	-	51	14	11	14	4	002	●
HAND TAPS	M20X2.5	P4	17.5	17.63	TNMS020R5-L	5P	105	33	-	50	15	12	15	4	002	○
		P4	17.5	17.63	TNMS020R1-L	1.5P	105	33	-	50	15	12	15	4	002	●
EG (STI)	M22X2.5	P4	19.5	19.63	TNMS022R5-L	5P	115	33	-	55	17	13	16	4	002	○
		P4	19.5	19.63	TNMS022R1-L	1.5P	115	33	-	55	17	13	16	4	002	●
SPECIAL THREADS, GAUGES	M24X3	P4	21	21.13	TNMS024S5-L	5P	120	39	-	55	19	15	18	4	002	○
		P4	21	21.13	TNMS024S1-L	1.5P	120	39	-	55	19	15	18	4	002	●
		P4	24	24.13	TNMS027S5-L	5P	130	39	-	60	20	15	18	4	002	○
THREAD MILLS	M27X3	P4	24	24.13	TNMS027S1-L	1.5P	130	39	-	60	20	15	18	4	002	○
		P4	26.5	26.63	TNMS030T5-L	5P	135	46	-	62	23	17	20	4	002	○
DIES	M30X3.5	P4	26.5	26.63	TNMS030T1-L	1.5P	135	46	-	62	23	17	20	4	002	○
		P4	29.5	29.63	TNMS033T5-L	5P	145	46	-	67	25	19	22	4	002	○
SPECIAL THREADS, GAUGES	M33X3.5	P4	29.5	29.63	TNMS033T1-L	1.5P	145	46	-	67	25	19	22	4	002	○
		P5	32	32.12	TNMT036U5-L	5P	155	52	-	71	28	21	24	4	002	○
DIES	M36X4	P5	32	32.12	TNMT036U1-L	1.5P	155	52	-	71	28	21	24	4	002	○
		P5	35	35.12	TNMT039U5-L	5P	165	52	-	76	30	23	26	4	002	○
		P5	35	35.12	TNMT039U1-L	1.5P	165	52	-	76	30	23	26	4	002	○
THREAD MILLS	M42X4.5	P5	37.5	37.63	TNMT042V5-L	5P	175	59	-	81	32	26	30	4	002	○
		P5	37.5	37.63	TNMT042V1-L	1.5P	175	59	-	81	32	26	30	4	002	○
DIES	M45X4.5	P5	40.5	40.63	TNMT045V5-L	5P	180	59	-	83	35	26	30	4	002	○
		P5	40.5	40.63	TNMT045V1-L	1.5P	180	59	-	83	35	26	30	4	002	○
DIES	M48X5	P5	43	43.12	TNMT048W5-L	5P	185	65	-	85	38	29	32	4	002	○
		P5	43	43.12	TNMT048W1-L	1.5P	185	65	-	85	38	29	32	4	002	○
	MF	TCTR (tolerance)	 Hole Ø (mm)	Hole Ø (mm)	Code	THCHT (chamfer)	LF (mm)	THL (mm)	LU (mm)	LS (mm)	DCON (mm)	K (mm)	LK (mm)	NOF	Type	Stock
	JIS															
CENTER DRILLS	M3X0.35	P2	2.7	2.7	TNMQ3.0D5-L	5P	46	6.5	14	26	4	3.2	6	3	001	○
		P2	2.7	2.7	TNMQ3.0D1-L	1.5P	46	6.5	14	26	4	3.2	6	3	001	○

Technical info

MF	TCTR (tolerance)	 Hole Ø (mm)	Hole Ø (mm)	Code	THCHT (chamfer)	LF (mm)	THL (mm)	LU (mm)	LS (mm)	DCON (mm)	K (mm)	LK (mm)	NOF	Type	Stock
JIS															
M4X0.5	P2	3.5	3.56	TNMQ4.0G5-L	5P	52	9	17	29	5	4	7	4	001	○
	P2	3.5	3.56	TNMQ4.0G1-L	1.5P	52	9	17	29	5	4	7	4	001	○
M5X0.5	P2	4.5	4.56	TNMQ5.0G5-L	5P	60	9	22	33	5.5	4.5	7	4	001	○
	P2	4.5	4.56	TNMQ5.0G1-L	1.5P	60	9	22	33	5.5	4.5	7	4	001	○
M6X0.75	P2	5.3	5.33	TNMQ6.0J5-L	5P	62	15	26	33	6	4.5	7	4	001	○
	P2	5.3	5.33	TNMQ6.0J1-L	1.5P	62	15	26	33	6	4.5	7	4	001	●
M6X0.5	P2	5.5	5.56	TNMQ6.0G5-L	5P	62	9	26	33	6	4.5	7	4	001	○
	P2	5.5	5.56	TNMQ6.0G1-L	1.5P	62	9	26	33	6	4.5	7	4	001	○
M7X0.75	P2	6.3	6.33	TNMQ7.0J5-L	5P	70	19	-	36	6.2	5	8	4	002	○
	P2	6.3	6.33	TNMQ7.0J1-L	1.5P	70	19	-	36	6.2	5	8	4	002	○
M8X1	P2	7	7.09	TNMQ8.0M5-L	5P	70	19	-	36	6.2	5	8	4	002	○
	P2	7	7.09	TNMQ8.0M1-L	1.5P	70	19	-	36	6.2	5	8	4	002	●
M8X0.75	P2	7.3	7.33	TNMQ8.0J5-L	5P	70	19	-	36	6.2	5	8	4	002	○
	P2	7.3	7.33	TNMQ8.0J1-L	1.5P	70	19	-	36	6.2	5	8	4	002	●
M8X0.5	P2	7.5	7.56	TNMQ8.0G5-L	5P	70	10	-	36	6.2	5	8	4	037	○
	P2	7.5	7.56	TNMQ8.0G1-L	1.5P	70	10	-	36	6.2	5	8	4	037	○
M9X1	P2	8	8.09	TNMQ9.0M5-L	5P	75	23	-	38	7	5.5	8	4	002	○
	P2	8	8.09	TNMQ9.0M1-L	1.5P	75	23	-	38	7	5.5	8	4	002	○
M9X0.75	P2	8.3	8.33	TNMQ9.0J5-L	5P	75	13	-	38	7	5.5	8	4	037	○
	P2	8.3	8.33	TNMQ9.0J1-L	1.5P	75	13	-	38	7	5.5	8	4	037	○
M10X1.25	P3	8.8	8.85	TNMR010N5-L	5P	75	23	-	38	7	5.5	8	4	002	○
	P3	8.8	8.85	TNMR010N1-L	1.5P	75	23	-	38	7	5.5	8	4	002	●
M10X1	P3	9	9.09	TNMR010M5-L	5P	75	23	-	38	7	5.5	8	4	002	○
	P3	9	9.09	TNMR010M1-L	1.5P	75	23	-	38	7	5.5	8	4	002	●
M11X1.25	P3	9.8	9.85	TNMR011N5-L	5P	82	26	-	42	8.5	6.5	9	4	002	○
	P3	9.8	9.85	TNMR011N1-L	1.5P	82	26	-	42	8.5	6.5	9	4	002	○
M11X1	P3	10	10.1	TNMR011M5-L	5P	82	26	-	42	8.5	6.5	9	4	002	○
	P3	10	10.1	TNMR011M1-L	1.5P	82	26	-	42	8.5	6.5	9	4	002	○
M12X1.5	P3	10.5	10.6	TNMR012O5-L	5P	82	26	-	42	8.5	6.5	9	4	002	○
	P3	10.5	10.6	TNMR012O1-L	1.5P	82	26	-	42	8.5	6.5	9	4	002	●
M12X1.25	P4	10.8	10.85	TNMS012N5-L	5P	82	26	-	42	8.5	6.5	9	4	002	○
	P4	10.8	10.85	TNMS012N1-L	1.5P	82	26	-	42	8.5	6.5	9	4	002	●
M12X1	P3	11	11.09	TNMR012M5-L	5P	82	26	-	42	8.5	6.5	9	4	002	○
	P3	11	11.09	TNMR012M1-L	1.5P	82	26	-	42	8.5	6.5	9	4	002	●
M13X1.5	P3	11.5	11.6	TNMR013O5-L	5P	88	26	-	45	10.5	8	11	4	002	○
	P3	11.5	11.6	TNMR013O1-L	1.5P	88	26	-	45	10.5	8	11	4	002	○
M13X1.25	P4	11.8	11.85	TNMS013N5-L	5P	88	26	-	45	10.5	8	11	4	002	○
	P4	11.8	11.85	TNMS013N1-L	1.5P	88	26	-	45	10.5	8	11	4	002	○
M13X1	P3	12	12.09	TNMR013M5-L	5P	88	26	-	45	10.5	8	11	4	002	○
	P3	12	12.09	TNMR013M1-L	1.5P	88	26	-	45	10.5	8	11	4	002	○
M14X1.5	P3	12.5	12.6	TNMR014O5-L	5P	88	26	-	45	10.5	8	11	4	002	○
	P3	12.5	12.6	TNMR014O1-L	1.5P	88	26	-	45	10.5	8	11	4	002	●
M14X1.25	P4	12.8	12.85	TNMS014N5-L	5P	88	26	-	45	10.5	8	11	4	002	○
	P4	12.8	12.85	TNMS014N1-L	1.5P	88	26	-	45	10.5	8	11	4	002	○
M14X1	P3	13	13.09	TNMR014M5-L	5P	88	26	-	45	10.5	8	11	4	002	○
	P3	13	13.09	TNMR014M1-L	1.5P	88	26	-	45	10.5	8	11	4	002	●

Intro

SP

SL

PO

ST
JIS

ROLL

CARBIDE

LONG

HAND TAPS

EG (STI)

SPECIAL THREADS, GAUGES

THREAD MILLS

DIES

CENTER DRILLS

Technical info

Straight Fluted Taps

Intro

SP

SL

PO

ST

JIS

ROLL

CARBIDE

LONG

HAND TAPS

EG (STI)

SPECIAL THREADS, GAUGES

THREAD MILLS

DIES

CENTER DRILLS

Technical info

MF	TCTR (tolerance)	\varnothing (mm)	Hole \varnothing (mm)	Code	THCHT (chamfer)	LF (mm)	THL (mm)	LU (mm)	LS (mm)	DCON (mm)	K (mm)	LK (mm)	NOF	Type	Stock
JIS															
M15X1.5	P3	13.5	13.6	TNMR01505-L	5P	95	26	-	48	12.5	10	13	4	002	○
	P3	13.5	13.6	TNMR01501-L	1.5P	95	26	-	48	12.5	10	13	4	002	○
M15X1.25	P4	13.8	13.85	TNMS015N5-L	5P	95	26	-	48	12.5	10	13	4	002	○
	P4	13.8	13.85	TNMS015N1-L	1.5P	95	26	-	48	12.5	10	13	4	002	○
M15X1	P3	14	14.09	TNMR015M5-L	5P	95	26	-	48	12.5	10	13	4	002	○
	P3	14	14.09	TNMR015M1-L	1.5P	95	26	-	48	12.5	10	13	4	002	○
M16X1.5	P3	14.5	14.6	TNMR01605-L	5P	95	26	-	48	12.5	10	13	4	002	○
	P3	14.5	14.6	TNMR01601-L	1.5P	95	26	-	48	12.5	10	13	4	002	●
M16X1.25	P4	14.8	14.85	TNMS016N5-L	5P	95	26	-	48	12.5	10	13	4	002	○
	P4	14.8	14.85	TNMS016N1-L	1.5P	95	26	-	48	12.5	10	13	4	002	○
M16X1	P3	15	15.09	TNMR016M5-L	5P	95	26	-	48	12.5	10	13	4	002	○
	P3	15	15.09	TNMR016M1-L	1.5P	95	26	-	48	12.5	10	13	4	002	●
M17X2	P3	15	15.1	TNMR017Q5-L	5P	100	33	-	51	14	11	14	4	002	○
	P3	15	15.1	TNMR017Q1-L	1.5P	100	33	-	51	14	11	14	4	002	○
M17X1.5	P4	15.5	15.6	TNMS017O5-L	5P	100	33	-	51	14	11	14	4	002	○
	P4	15.5	15.6	TNMS017O1-L	1.5P	100	33	-	51	14	11	14	4	002	○
M17X1	P3	16	16.09	TNMR017M5-L	5P	100	18	-	51	14	11	14	4	037	○
	P3	16	16.09	TNMR017M1-L	1.5P	100	18	-	51	14	11	14	4	037	○
M18X2	P4	16	16.12	TNMS018Q5-L	5P	100	33	-	51	14	11	14	4	002	○
	P4	16	16.12	TNMS018Q1-L	1.5P	100	33	-	51	14	11	14	4	002	○
M18X1.5	P3	16.5	16.6	TNMR018O5-L	5P	100	33	-	51	14	11	14	4	002	○
	P3	16.5	16.6	TNMR018O1-L	1.5P	100	33	-	51	14	11	14	4	002	●
M18X1	P3	17	17.09	TNMR018M5-L	5P	100	18	-	51	14	11	14	4	037	○
	P3	17	17.09	TNMR018M1-L	1.5P	100	18	-	51	14	11	14	4	037	○
M19X2	P4	17	17.12	TNMS019Q5-L	5P	105	33	-	50	15	12	15	4	002	○
	P4	17	17.12	TNMS019Q1-L	1.5P	105	33	-	50	15	12	15	4	002	○
M19X1.5	P3	17.5	17.6	TNMR019O5-L	5P	105	33	-	50	15	12	15	4	002	○
	P3	17.5	17.6	TNMR019O1-L	1.5P	105	33	-	50	15	12	15	4	002	○
M19X1	P3	18	18.09	TNMR019M5-L	5P	105	18	-	50	15	12	15	4	037	○
	P3	18	18.09	TNMR019M1-L	1.5P	105	18	-	50	15	12	15	4	037	○
M20X2	P4	18	18.12	TNMS020Q5-L	5P	105	33	-	50	15	12	15	4	002	○
	P4	18	18.12	TNMS020Q1-L	1.5P	105	33	-	50	15	12	15	4	002	○
M20X1.5	P3	18.5	18.6	TNMR020O5-L	5P	105	33	-	50	15	12	15	4	002	○
	P3	18.5	18.6	TNMR020O1-L	1.5P	105	33	-	50	15	12	15	4	002	●
M20X1	P3	19	19.09	TNMR020M5-L	5P	105	18	-	50	15	12	15	4	037	○
	P3	19	19.09	TNMR020M1-L	1.5P	105	18	-	50	15	12	15	4	037	○
M21X2	P4	19	19.1	TNMS021Q5-L	5P	115	33	-	55	17	13	16	4	002	○
	P4	19	19.1	TNMS021Q1-L	1.5P	115	33	-	55	17	13	16	4	002	○
M21X1.5	P3	19.5	19.6	TNMR021O5-L	5P	115	33	-	55	17	13	16	4	002	○
	P3	19.5	19.6	TNMR021O1-L	1.5P	115	33	-	55	17	13	16	4	002	○
M21X1	P3	20	20.09	TNMR021M5-L	5P	115	19	-	55	17	13	16	4	037	○
	P3	20	20.09	TNMR021M1-L	1.5P	115	19	-	55	17	13	16	4	037	○
M22X2	P4	20	20.12	TNMS022Q5-L	5P	115	33	-	55	17	13	16	4	002	○
	P4	20	20.12	TNMS022Q1-L	1.5P	115	33	-	55	17	13	16	4	002	○
M22X1.5	P3	20.5	20.6	TNMR022O5-L	5P	115	33	-	55	17	13	16	4	002	○
	P3	20.5	20.6	TNMR022O1-L	1.5P	115	33	-	55	17	13	16	4	002	○

MF	TCTR (tolerance)	∅ (mm)	Hole ∅ (mm)	Code	THCHT (chamfer)	LF (mm)	THL (mm)	LU (mm)	LS (mm)	DCON (mm)	K (mm)	LK (mm)	NOF	Type	Stock	
JIS																Intro
M22X1	P3	21	21.09	TNMR022M5-L	5P	115	19	-	55	17	13	16	4	037	○	
	P3	21	21.09	TNMR022M1-L	1.5P	115	19	-	55	17	13	16	4	037	○	SP
M23X1.5	P3	21.5	21.6	TNMR023O5-L	5P	120	39	-	55	19	15	18	4	002	○	
	P3	21.5	21.6	TNMR023O1-L	1.5P	120	39	-	55	19	15	18	4	002	○	
M23X1	P3	22	22.09	TNMR023M5-L	5P	120	39	-	55	19	15	18	4	037	○	
	P3	22	22.09	TNMR023M1-L	1.5P	120	39	-	55	19	15	18	4	037	○	SL
M24X2	P4	22	22.12	TNMS024Q5-L	5P	120	39	-	55	19	15	18	4	002	○	
	P4	22	22.12	TNMS024Q1-L	1.5P	120	39	-	55	19	15	18	4	002	○	
M24X1.5	P3	22.5	22.6	TNMR024O5-L	5P	120	39	-	55	19	15	18	4	002	○	
	P3	22.5	22.6	TNMR024O1-L	1.5P	120	39	-	55	19	15	18	4	002	○	PO
M24X1	P3	23	23.09	TNMR024M5-L	5P	120	19	-	55	19	15	18	4	037	○	
	P3	23	23.09	TNMR024M1-L	1.5P	120	19	-	55	19	15	18	4	037	○	
M25X3	P4	22	22.12	TNMS025S5-L	5P	125	39	-	58	19	15	18	4	002	○	
	P4	22	22.12	TNMS025S1-L	1.5P	125	39	-	58	19	15	18	4	002	○	ST JIS
M25X2	P4	23	23.12	TNMS025Q5-L	5P	125	39	-	58	19	15	18	4	002	○	
	P4	23	23.12	TNMS025Q1-L	1.5P	125	39	-	58	19	15	18	4	002	○	ROLL
M25X1.5	P3	23.5	23.6	TNMR025O5-L	5P	125	39	-	58	19	15	18	4	002	○	
	P3	23.5	23.6	TNMR025O1-L	1.5P	125	39	-	58	19	15	18	4	002	○	
M25X1	P3	24	24.09	TNMR025M5-L	5P	125	20	-	58	19	15	18	4	037	○	
	P3	24	24.09	TNMR025M1-L	1.5P	125	20	-	58	19	15	18	4	037	○	CARBIDE
M26X2	P4	24	24.12	TNMS026Q5-L	5P	130	39	-	60	20	15	18	4	002	○	
	P4	24	24.12	TNMS026Q1-L	1.5P	130	39	-	60	20	15	18	4	002	○	
M26X1.5	P3	24.5	24.6	TNMR026O5-L	5P	130	39	-	60	20	15	18	4	002	○	
	P3	24.5	24.6	TNMR026O1-L	1.5P	130	39	-	60	20	15	18	4	002	○	LONG
M26X1	P3	25	25.09	TNMR026M5-L	5P	130	20	-	60	20	15	18	4	037	○	
	P3	25	25.09	TNMR026M1-L	1.5P	130	20	-	60	20	15	18	4	037	○	
M27X2	P5	25	25.12	TNMT027Q5-L	5P	130	39	-	60	20	15	18	4	002	○	
	P5	25	25.12	TNMT027Q1-L	1.5P	130	39	-	60	20	15	18	4	002	○	HAND TAPS
M27X1.5	P3	25.5	25.6	TNMR027O5-L	5P	130	39	-	60	20	15	18	4	002	○	
	P3	25.5	25.6	TNMR027O1-L	1.5P	130	39	-	60	20	15	18	4	002	○	
M27X1	P3	26	26.09	TNMR027M5-L	5P	130	20	-	60	20	15	18	4	037	○	
	P3	26	26.09	TNMR027M1-L	1.5P	130	20	-	60	20	15	18	4	037	○	EG (STI)
M28X2	P4	26	26.12	TNMS028Q5-L	5P	135	46	-	62	23	17	20	4	002	○	
	P4	26	26.12	TNMS028Q1-L	1.5P	135	46	-	62	23	17	20	4	002	○	SPECIAL THREADS, GAUGES
M28X1.5	P3	26.5	26.6	TNMR028O5-L	5P	135	46	-	62	23	17	20	4	002	○	
	P3	26.5	26.6	TNMR028O1-L	1.5P	135	46	-	62	23	17	20	4	002	○	
M28X1	P3	27	27.09	TNMR028M5-L	5P	135	20	-	62	23	17	20	4	037	○	
	P3	27	27.09	TNMR028M1-L	1.5P	135	20	-	62	23	17	20	4	037	○	THREAD MILLS
M30X3	P5	27	27.13	TNMT030S5-L	5P	135	46	-	62	23	17	20	4	002	○	
	P5	27	27.13	TNMT030S1-L	1.5P	135	46	-	62	23	17	20	4	002	○	
M30X2	P4	28	28.12	TNMS030Q5-L	5P	135	46	-	62	23	17	20	4	002	○	
	P4	28	28.12	TNMS030Q1-L	1.5P	135	46	-	62	23	17	20	4	002	○	DIES
M30X1.5	P3	28.5	28.6	TNMR030O5-L	5P	135	46	-	62	23	17	20	4	002	○	
	P3	28.5	28.6	TNMR030O1-L	1.5P	135	46	-	62	23	17	20	4	002	○	
M30X1	P3	29	29.09	TNMR030M5-L	5P	135	21	-	62	23	17	20	4	037	○	
	P3	29	29.09	TNMR030M1-L	1.5P	135	21	-	62	23	17	20	4	037	○	CENTER DRILLS

Technical
info

Straight Fluted Taps

Intro

SP

SL

PO

ST

JIS

ROLL

CARBIDE

LONG

HAND
TAPS

EG (STI)

SPECIAL
THREADS,
GAUGES

THREAD
MILLS

DIES

CENTER
DRILLS

Technical
info

MF	TCTR (tolerance)	\varnothing (mm)	Hole \varnothing (mm)	Code	THCHT (chamfer)	LF (mm)	THL (mm)	LU (mm)	LS (mm)	DCON (mm)	K (mm)	LK (mm)	NOF	Type	Stock
JIS															
M32X2	P4	30	30.12	TNMS032Q5-L	5P	145	46	-	67	24	19	22	4	002	○
	P4	30	30.12	TNMS032Q1-L	1.5P	145	46	-	67	24	19	22	4	002	○
M32X1.5	P4	30.5	30.6	TNMS032O5-L	5P	145	46	-	67	24	19	22	4	002	○
	P4	30.5	30.6	TNMS032O1-L	1.5P	145	46	-	67	24	19	22	4	002	○
M33X3	P5	30	30.13	TNMT033S5-L	5P	145	46	-	67	25	19	22	4	002	○
	P5	30	30.13	TNMT033S1-L	1.5P	145	46	-	67	25	19	22	4	002	○
M33X2	P4	31	31.12	TNMS033Q5-L	5P	145	46	-	67	25	19	22	4	002	○
	P4	31	31.12	TNMS033Q1-L	1.5P	145	46	-	67	25	19	22	4	002	○
M33X1.5	P4	31.5	31.6	TNMS033O5-L	5P	145	46	-	67	25	19	22	4	002	○
	P4	31.5	31.6	TNMS033O1-L	1.5P	145	46	-	67	25	19	22	4	002	○
M34X2	P4	32	32.12	TNMS034Q5-L	5P	155	52	-	71	28	21	24	4	002	○
	P4	32	32.12	TNMS034Q1-L	1.5P	155	52	-	71	28	21	24	4	002	○
M34X1.5	P4	35.5	32.6	TNMS034O5-L	5P	155	26	-	71	28	21	24	4	037	○
	P4	35.5	32.6	TNMS034O1-L	1.5P	155	26	-	71	28	21	24	4	037	○
M35X2	P5	33	33.12	TNMT035Q5-L	5P	155	52	-	71	28	21	24	4	002	○
	P5	33	33.12	TNMT035Q1-L	1.5P	155	52	-	71	28	21	24	4	002	○
M35X1.5	P4	33.5	33.6	TNMS035O5-L	5P	155	26	-	71	28	21	24	4	037	○
	P4	33.5	33.6	TNMS035O1-L	1.5P	155	26	-	71	28	21	24	4	037	○
M36X3	P5	33	33.13	TNMT036S5-L	5P	155	52	-	71	28	21	24	4	002	○
	P5	33	33.13	TNMT036S1-L	1.5P	155	52	-	71	28	21	24	4	002	○
M36X2	P4	34	34.12	TNMS036Q5-L	5P	155	52	-	71	28	21	24	4	002	○
	P4	34	34.12	TNMS036Q1-L	1.5P	155	52	-	71	28	21	24	4	002	○
M36X1.5	P4	34.5	34.6	TNMS036O5-L	5P	155	26	-	71	28	21	24	4	037	○
	P4	34.5	34.6	TNMS036O1-L	1.5P	155	26	-	71	28	21	24	4	037	○
M38X2	P4	36	36.12	TNMS038Q5-L	5P	165	52	-	76	30	23	26	4	002	○
	P4	36	36.12	TNMS038Q1-L	1.5P	165	52	-	76	30	23	26	4	002	○
M38X1.5	P4	36.5	36.6	TNMS038O5-L	5P	165	26	-	76	30	23	26	4	037	○
	P4	36.5	36.6	TNMS038O1-L	1.5P	165	26	-	76	30	23	26	4	037	○
M39X3	P5	36	36.13	TNMT039S5-L	5P	165	52	-	76	30	23	26	4	002	○
	P5	36	36.13	TNMT039S1-L	1.5P	165	52	-	76	30	23	26	4	002	○
M39X2	P5	37	37.12	TNMT039Q5-L	5P	165	52	-	76	30	23	26	4	002	○
	P5	37	37.12	TNMT039Q1-L	1.5P	165	52	-	76	30	23	26	4	002	○
M39X1.5	P4	37.5	37.6	TNMS039O5-L	5P	165	26	-	76	30	23	26	4	037	○
	P4	37.5	37.6	TNMS039O1-L	1.5P	165	26	-	76	30	23	26	4	037	○
M40X3	P5	37	37.13	TNMT040S5-L	5P	175	59	-	81	32	26	30	4	002	○
	P5	37	37.13	TNMT040S1-L	1.5P	175	59	-	81	32	26	30	4	002	○
M40X2	P4	38	38.12	TNMS040Q5-L	5P	175	59	-	81	32	26	30	4	002	○
	P4	38	38.12	TNMS040Q1-L	1.5P	175	59	-	81	32	26	30	4	002	○
M40X1.5	P4	38.5	38.6	TNMS040O5-L	5P	175	27	-	81	32	26	30	4	037	○
	P4	38.5	38.6	TNMS040O1-L	1.5P	175	27	-	81	32	26	30	4	037	○
M42X3	P5	39	39.13	TNMT042S5-L	5P	175	59	-	81	32	26	30	4	002	○
	P5	39	39.13	TNMT042S1-L	1.5P	175	59	-	81	32	26	30	4	002	○
M42X2	P4	40	40.12	TNMS042Q5-L	5P	175	59	-	81	32	26	30	4	002	○
	P4	40	40.12	TNMS042Q1-L	1.5P	175	59	-	81	32	26	30	4	002	○
M42X1.5	P4	40.5	40.6	TNMS042O5-L	5P	175	27	-	81	32	26	30	4	037	○
	P4	40.5	40.6	TNMS042O1-L	1.5P	175	27	-	81	32	26	30	4	037	○

MF	TCTR (tolerance)	 Hole Ø (mm)	Hole Ø (mm)	Code	THCHT (chamfer)	LF (mm)	THL (mm)	LU (mm)	LS (mm)	DCON (mm)	K (mm)	LK (mm)	NOF	Type	Stock
JIS															
M45X3	P5	42	42.13	TNMT045S5-L	5P	180	59	-	83	35	26	30	4	002	○
	P5	42	42.13	TNMT045S1-L	1.5P	180	59	-	83	35	26	30	4	002	○
M45X2	P4	43	43.12	TNMS045Q5-L	5P	180	59	-	83	35	26	30	4	002	○
	P4	43	43.12	TNMS045Q1-L	1.5P	180	59	-	83	35	26	30	4	002	○
M45X1.5	P4	43.5	43.6	TNMS045O5-L	5P	180	27	-	83	35	26	30	4	037	○
	P4	43.5	43.6	TNMS045O1-L	1.5P	180	27	-	83	35	26	30	4	037	○
M48X3	P6	45	45.13	TNMT048S5-L	5P	185	65	-	85	38	29	32	4	002	○
	P6	45	45.13	TNMT048S1-L	1.5P	185	65	-	85	38	29	32	4	002	○
M48X2	P4	46	46.12	TNMS048Q5-L	5P	185	65	-	85	38	29	32	4	002	○
	P4	46	46.12	TNMS048Q1-L	1.5P	185	65	-	85	38	29	32	4	002	○
M48X1.5	P4	46.5	46.6	TNMS048O5-L	5P	185	28	-	85	38	29	32	4	037	○
	P4	46.5	46.6	TNMS048O1-L	1.5P	185	28	-	85	38	29	32	4	037	○
M50X3	II	47	47.13	TH2050S5-L	5P	180	80	-	100	40	32	35	4	002	○
	II	47	47.13	TH2050S1-L	1.5P	180	80	-	100	40	32	35	4	002	○
M50X2	II	48	48.12	TH2050Q5-L	5P	130	45	-	85	40	32	35	4	002	○
	II	48	48.12	TH2050Q1-L	1.5P	130	45	-	85	40	32	35	4	002	○
M50X1.5	II	48.5	48.6	TH2050O5-L	5P	130	45	-	85	40	32	35	4	002	○
	II	48.5	48.6	TH2050O1-L	1.5P	130	45	-	85	40	32	35	4	002	○
UNC															
JIS															
No.5-40UNC	P2	2.6	2.64	TNMQUN5H5-L	5P	52	11	16	28	5	4	7	3	001	○
	P2	2.6	2.64	TNMQUN5H1-L	1.5P	52	11	16	28	5	4	7	3	001	○
No.10-24UNC	P2	3.89	3.9	TNMQUNAM5-L	5P	60	13	22	32	5.5	4.5	7	4	001	○
	P2	3.89	3.9	TNMQUNAM1-L	1.5P	60	13	22	32	5.5	4.5	7	4	001	○
5/8-11UNC	P4	13.6	13.75	TNMSU10U5-L	5P	95	26	-	48	12.5	10	13	4	002	○
	P4	13.6	13.75	TNMSU10U1-L	1.5P	95	26	-	48	12.5	10	13	4	002	○
7/8-9UNC	P4	19.6	19.61	TNMSU14W5-L	5P	115	33	-	55	17	13	16	4	002	○
	P4	19.6	19.61	TNMSU14W1-L	1.5P	115	33	-	55	17	13	16	4	002	○
1-8UNC	P4	22.3	22.45	TNMSU16X5-L	5P	125	39	-	58	19	15	18	4	002	○
	P4	22.3	22.45	TNMSU16X1-L	1.5P	125	39	-	58	19	15	18	4	002	○
UNF															
JIS															
No.12-28UNF	P2	4.6	4.67	TNMQUCK5-L	5P	62	15	26	32	6	4.5	7	4	001	○
	P2	4.6	4.67	TNMQUCK1-L	1.5P	62	15	26	32	6	4.5	7	4	001	○
1/4-28UNF	P2	5.5	5.53	TNMQU04K1-L	5P	62	15	26	33	6	4.5	7	4	001	○
	P2	5.5	5.53	TNMQU04K5-L	1.5P	62	15	26	33	6	4.5	7	4	001	○
5/16-24UNF	P2	6.9	6.97	TNMQU05M5-L	5P	70	19	-	36	6.2	5	8	4	002	○
	P2	6.9	6.97	TNMQU05M1-L	1.5P	70	19	-	36	6.2	5	8	4	002	○
7/16-20UNF	P3	9.9	9.96	TNMRU07N5-L	5P	82	26	-	42	8.5	6.5	9	4	002	○
	P3	9.9	9.96	TNMRU07N1-L	1.5P	82	26	-	42	8.5	6.5	9	4	002	○
9/16-18UNF	P3	12.9	13	TNMRU09O5-L	5P	95	26	-	48	12.5	10	13	4	002	○
	P3	12.9	13	TNMRU09O1-L	1.5P	95	26	-	48	12.5	10	13	4	002	○
5/8-18UNF	P3	14.5	14.6	TNMRU10O5-L	5P	95	26	-	48	12.5	10	13	4	002	○
	P3	14.5	14.6	TNMRU10O1-L	1.5P	95	26	-	48	12.5	10	13	4	002	○
3/4-16UNF	P3	17.5	17.59	TNMRU12P5-L	5P	105	33	-	50	15	12	15	4	002	○

Intro

SP

SL

PO

ST

JIS

ROLL

CARBIDE

LONG

HAND TAPS

EG (STI)

SPECIAL THREADS, GAUGES

THREAD MILLS

DIES

CENTER DRILLS

Technical info

Straight Fluted Taps

Intro

	UNF	TCTR (tolerance)	\varnothing (mm)	Hole \varnothing (mm)	Code	THCHT (chamfer)	LF (mm)	THL (mm)	LU (mm)	LS (mm)	DCON (mm)	K (mm)	LK (mm)	NOF	Type	Stock
	JIS															
SP	1 -12UNF	P4	23.3	23.46	TNMSU16S5-L	5P	125	39	-	58	19	15	18	4	002	○
		P4	23.3	23.46	TNMSU16S1-L	1.5P	125	39	-	58	19	15	18	4	002	○
	BSW	TCTR (tolerance)	\varnothing (mm)	Hole \varnothing (mm)	Code	THCHT (chamfer)	LF (mm)	THL (mm)	LU (mm)	LS (mm)	DCON (mm)	K (mm)	LK (mm)	NOF	Type	Stock
	JIS															
SL	1/8W40	P2	2.55	2.56	TNMQW02H5-L	5P	52	11	16	28	5	4	7	3	001	○
		P2	2.55	2.56	TNMQW02H1-L	1.5P	52	11	16	28	5	4	7	3	001	○
PO	3/16W24	P3	3.7	3.7	TNMRW03M5-L	5P	60	13	21	33	5.5	4.5	7	4	001	○
		P3	3.7	3.7	TNMRW03M1-L	1.5P	60	13	21	33	5.5	4.5	7	4	001	○
ST	1/4W20	P3	5.1	5.13	TNMRW04N5-L	5P	62	15	26	33	6	4.5	7	4	001	○
		P3	5.1	5.13	TNMRW04N1-L	1.5P	62	15	26	33	6	4.5	7	4	001	○
JIS	5/16W18	P3	6.5	6.59	TNMRW05O5-L	5P	70	19	-	36	6.2	5	8	4	002	○
		P3	6.5	6.59	TNMRW05O1-L	1.5P	70	19	-	36	6.2	5	8	4	002	○
ROLL	3/8W16	P3	8	8.02	TNMRW06P5-L	5P	75	23	-	38	7	5.5	8	4	002	○
		P3	8	8.02	TNMRW06P1-L	1.5P	75	23	-	38	7	5.5	8	4	002	○
CARBIDE	7/16W14	P4	9.3	9.39	TNMSW07Q5-L	5P	82	26	-	42	8.5	6.5	9	4	002	○
		P4	9.3	9.39	TNMSW07Q1-L	1.5P	82	26	-	42	8.5	6.5	9	4	002	○
LONG	1/2W12	P4	10.6	10.7	TNMSW08S5-L	5P	88	26	-	45	10.5	8	11	4	002	○
		P4	10.6	10.7	TNMSW08S1-L	1.5P	88	26	-	45	10.5	8	11	4	002	○
HAND TAPS	9/16W12	P4	12.25	12.29	TNMSW09S5-L	5P	95	26	-	48	12.5	10	13	4	002	○
		P4	12.25	12.29	TNMSW09S1-L	1.5P	95	26	-	48	12.5	10	13	4	002	○
EG (STI)	5/8W11	P4	13.5	13.68	TNMSW10U5-L	5P	95	26	-	48	12.5	10	13	4	002	○
		P4	13.5	13.68	TNMSW10U1-L	1.5P	95	26	-	48	12.5	10	13	4	002	○
SPECIAL THREADS, GAUGES	3/4W10	P4	16.5	16.63	TNMSW12V5-L	5P	105	33	-	50	15	12	15	4	002	○
		P4	16.5	16.63	TNMSW12V1-L	1.5P	105	33	-	50	15	12	15	4	002	○
THREAD MILLS	7/8W9	P5	19.5	19.53	TNMTW14W5-L	5P	115	33	-	55	17	13	16	4	002	○
		P5	19.5	19.53	TNMTW14W1-L	1.5P	115	33	-	55	17	13	16	4	002	○
DIES	1 W8	P5	22.2	22.34	TNMTW16X5-L	5P	125	39	-	58	19	15	18	4	002	○
		P5	22.2	22.34	TNMTW16X1-L	1.5P	125	39	-	58	19	15	18	4	002	○
CENTER DRILLS	1 1/8W7	P5	24.75	25.04	TNMTW18Y5-L	5P	135	46	-	62	23	17	20	4	002	○
		P5	24.75	25.04	TNMTW18Y1-L	1.5P	135	46	-	62	23	17	20	4	002	○

SPECIAL
THREADS,
GAUGESTHREAD
MILLS

DIES

CENTER
DRILLSTechnical
info

PF LH

GP General Purpose Series

Straight Fluted Taps for Parallel Pipe Threads, for Left Hand Threads



FEATURES

General purpose for blind and through hole application.
For steel application at low cutting speed, also suitable for cast iron and non-ferrous materials.
For left hand threads.

Recommended Tapping Speeds Depending On Materials

ISO	Vc (m/min)	ISO	Vc (m/min)	ISO	Vc (m/min)
P1	5÷10 ☆	K1	5÷10 ☆	N2	5÷10 ☆
P2	5÷10 ★	K2	5÷10 ☆	N3	5÷10 ☆
P3	5÷10 ☆			N4	5÷10 ☆
P4	5÷10 ☆				

★ 1st choice ☆ suitable

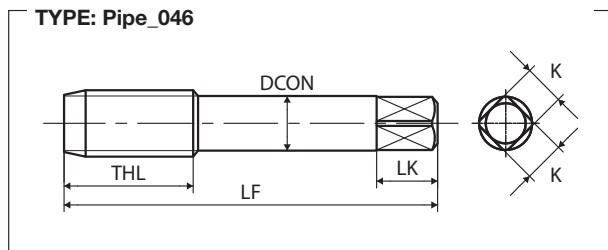

G(BSP)	TCTR (tolerance)	Hole Ø (mm)	Hole Ø (mm)	Code	THCHT (chamfer)	Basic major Ø (mm)	LF (mm)	THL (mm)	LS (mm)	DCON (mm)	K (mm)	LK (mm)	NOF	Type	Stock
JIS															
1/8-28		8.75	8.78	TH2F02K--L	3.5P	9.728	55	19	-	8	6	9	4	046	○
1/4-19		11.75	11.78	TH2F04---L	3.5P	13.157	62	28	-	11	9	12	4	046	○
3/8-19		15.25	15.28	TH2F06---L	3.5P	16.662	65	28	-	14	11	14	4	046	○
1/2-14		19	19.04	TH2F08Q--L	3.5P	20.955	80	35	-	18	14	17	4	046	○
3/4-14		24.5	24.52	TH2F12Q--L	3.5P	26.441	85	35	-	23	17	20	4	046	○
1-11		30.75	30.77	TH2F16U--L	3.5P	33.249	95	45	-	26	21	24	4	046	○
1 1/4-11		39.3	39.43	TH2F20U--L	3.5P	41.910	105	45	-	32	26	30	4	046	○
1 1/2-11		45.25	45.33	TH2F24U--L	3.5P	47.803	110	45	-	38	29	32	6	046	○
2-11		57	57.1	TH2F32U--L	3.5P	59.614	120	50	-	46	35	38	6	046	○

- Intro
- SP
- SL
- PO
- ST**
- JIS**
- ROLL
- CARBIDE
- LONG
- HAND TAPS
- EG (STI)
- SPECIAL THREADS, GAUGES
- THREAD MILLS
- DIES
- CENTER DRILLS
- Technical info

Intro

SU-HT

MS Material Specific Series

SP

Straight Fluted Taps for Stainless Steel

SL



PO

Recommended Tapping Speeds Depending On Materials

ISO	Vc (m/min)	☆	ISO	Vc (m/min)	☆
P2	≤5	☆	M1	≤5	★
P3	≤5	☆			
P4	≤5	☆			
P7	≤5	★			

★ 1st choice ☆ suitable

ST

JIS

ROLL

CARBIDE

LONG

HAND TAPS

EG (STI)

SPECIAL THREADS, GAUGES

THREAD MILLS

DIES

CENTER DRILLS

Technical info



FEATURES

Material specific for blind and through hole application.
 Specific design and OX treatment for stainless steel, steel and medium alloy steel application.
 1.5P chamfer for blind hole application, 5P chamfer for through hole application.

TYPE: HT_001

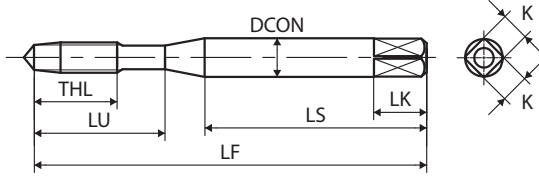

TYPE: HT_002

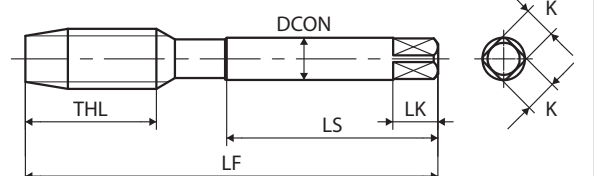

M	TCTR (tolerance)	∅ (mm)	Hole ∅ (mm)	Code	THCHT (chamfer)	LF (mm)	THL (mm)	LU (mm)	LS (mm)	DCON (mm)	K (mm)	LK (mm)	NOF	Type	Stock	
JIS																Intro
M2X0.4	P2	1.6	1.65	TUMQ2.0E4	4P	42	7.2	12	27	3	2.5	5	3	001	○	
	P2	1.6	1.65	TUMQ2.0E1	1.5P	42	7.2	12	27	3	2.5	5	3	001	○	SP
M2.3X0.4	P2	1.9	1.95	TUMQ2.3E4	4P	42	7.2	12	27	3	2.5	5	3	001	○	
	P2	1.9	1.95	TUMQ2.3E1	1.5P	42	7.2	12	27	3	2.5	5	3	001	○	SL
M2.5X0.45	P2	2.1	2.11	TUMQ2.5F4	4P	46	8.1	14	29	3	2.5	5	3	001	○	
	P2	2.1	2.11	TUMQ2.5F1	1.5P	46	8.1	14	29	3	2.5	5	3	001	○	SL
M2.6X0.45	P2	2.2	2.21	TUMQ2.6F4	4P	46	8.1	14	29	3	2.5	5	3	001	○	
	P2	2.2	2.21	TUMQ2.6F1	1.5P	46	8.1	14	29	3	2.5	5	3	001	○	
M3X0.5	P2	2.5	2.56	TUMQ3.0G4	4P	46	9	14	26	4	3.2	6	3	001	○	
	P2	2.5	2.56	TUMQ3.0G1	1.5P	46	9	14	26	4	3.2	6	3	001	○	PO
M3.5X0.6	P2	2.9	2.97	TUMQ3.5H4	4P	52	11	16	29	5	4	7	3	001	○	
	P2	2.9	2.97	TUMQ3.5H1	1.5P	52	11	16	29	5	4	7	3	001	○	
M4X0.7	P2	3.3	3.38	TUMQ4.0I4	4P	52	11	17	29	5	4	7	3	001	○	
	P2	3.3	3.38	TUMQ4.0I1	1.5P	52	11	17	29	5	4	7	3	001	○	ST JIS
M5X0.8	P2	4.2	4.28	TUMQ5.0K4	4P	60	13	22	33	5.5	4.5	7	3	001	○	
	P2	4.2	4.28	TUMQ5.0K1	1.5P	60	13	22	33	5.5	4.5	7	3	001	○	
M6X1	P2	5	5.09	TUMQ6.0M4	4P	62	15	26	33	6	4.5	7	3	001	○	
	P2	5	5.09	TUMQ6.0M1	1.5P	62	15	26	33	6	4.5	7	3	001	○	ROLL
M8X1.25	P3	6.8	6.85	TUMR8.0N4	4P	70	19	-	36	6.2	5	8	3	002	○	
	P3	6.8	6.85	TUMR8.0N1	1.5P	70	19	-	36	6.2	5	8	4	002	○	CARBIDE
M10X1.5	P3	8.5	8.6	TUMR01004	4P	75	23	-	38	7	5.5	8	3	002	○	
	P3	8.5	8.6	TUMR01001	1.5P	75	23	-	38	7	5.5	8	4	002	○	
M12X1.75	P4	10.3	10.36	TUMS012P4	4P	82	26	-	42	8.5	6.5	9	3	002	○	
	P4	10.3	10.36	TUMS012P1	1.5P	82	26	-	42	8.5	6.5	9	4	002	○	LONG
M14X2	P4	12	12.12	TUMS014Q4	4P	88	26	-	45	10.5	8	11	4	002	○	
	P4	12	12.12	TUMS014Q1	1.5P	88	26	-	45	10.5	8	11	4	002	○	
M16X2	P4	14	14.12	TUMS016Q4	4P	95	26	-	48	12.5	10	13	4	002	○	
	P4	14	14.12	TUMS016Q1	1.5P	95	26	-	48	12.5	10	13	4	002	○	HAND TAPS
M18X2.5	P4	15.5	15.63	TUMS018R4	4P	100	33	-	51	14	11	14	4	002	○	
	P4	15.5	15.63	TUMS018R1	1.5P	100	33	-	51	14	11	14	4	002	○	
M20X2.5	P4	17.5	17.63	TUMS020R4	4P	105	33	-	50	15	12	15	4	002	○	
	P4	17.5	17.63	TUMS020R1	1.5P	105	33	-	50	15	12	15	4	002	○	EG (STI)
M22X2.5	P4	19.5	19.63	TUMS022R4	4P	115	33	-	55	17	13	16	4	002	○	
	P4	19.5	19.63	TUMS022R1	1.5P	115	33	-	55	17	13	16	4	002	○	SPECIAL THREADS, GAUGES
M24X3	P4	21	21.13	TUMS024S4	4P	120	39	-	55	19	15	18	4	002	○	
	P4	21	21.13	TUMS024S1	1.5P	120	39	-	55	19	15	18	4	002	○	
M27X3	P4	24	24.13	TUMS027S4	4P	130	39	-	60	20	15	18	4	002	○	
	P4	24	24.13	TUMS027S1	1.5P	130	39	-	60	20	15	18	4	002	○	THREAD MILLS
M30X3.5	P5	26.5	26.63	TUMT030T4	4P	135	46	-	62	23	17	20	4	002	○	
	P5	26.5	26.63	TUMT030T1	1.5P	135	46	-	62	23	17	20	4	002	○	
MF	TCTR (tolerance)	∅ (mm)	Hole ∅ (mm)	Code	THCHT (chamfer)	LF (mm)	THL (mm)	LU (mm)	LS (mm)	DCON (mm)	K (mm)	LK (mm)	NOF	Type	Stock	
JIS																DIES
M6X0.75	P2	5.3	5.33	TUMQ6.0J4	4P	62	15	26	33	6	4.5	7	3	001	○	
	P2	5.3	5.33	TUMQ6.0J1	1.5P	62	15	26	33	6	4.5	7	3	001	○	CENTER DRILLS
M8X1	P3	7	7.09	TUMR8.0M4	4P	70	19	-	36	6.2	5	8	3	002	○	
	P3	7	7.09	TUMR8.0M1	1.5P	70	19	-	36	6.2	5	8	4	002	○	

Technical info

Straight Fluted Taps

Intro

	MF	TCTR (tolerance)	\varnothing (mm)	Hole \varnothing (mm)	Code	THCHT (chamfer)	LF (mm)	THL (mm)	LU (mm)	LS (mm)	DCON (mm)	K (mm)	LK (mm)	NOF	Type	Stock
JIS																
SP	M10X1.25	P3	8.8	8.85	TUMR010N4	4P	75	23	-	38	7	5.5	8	3	002	○
		P3	8.8	8.85	TUMR010N1	1.5P	75	23	-	38	7	5.5	8	4	002	○
SL	M10X1	P3	9	9.09	TUMR010M4	4P	75	23	-	38	7	5.5	8	3	002	○
		P3	9	9.09	TUMR010M1	1.5P	75	23	-	38	7	5.5	8	4	002	○
PO	M12X1.5	P3	10.5	10.6	TUMR01204	4P	82	26	-	42	8.5	6.5	9	3	002	○
		P3	10.5	10.6	TUMR01201	1.5P	82	26	-	42	8.5	6.5	9	4	002	○
ST	M12X1.25	P4	10.8	10.85	TUMS012N4	4P	82	26	-	42	8.5	6.5	9	3	002	○
		P4	10.8	10.85	TUMS012N1	1.5P	82	26	-	42	8.5	6.5	9	4	002	○
JIS	M12X1	P3	11	11.09	TUMR012M4	4P	82	26	-	42	8.5	6.5	9	3	002	○
		P3	11	11.09	TUMR012M1	1.5P	82	26	-	42	8.5	6.5	9	4	002	○
ROLL	M14X1.5	P3	12.5	12.6	TUMR01404	4P	88	26	-	45	10.5	8	11	4	002	○
		P3	12.5	12.6	TUMR01401	1.5P	88	26	-	45	10.5	8	11	4	002	○
CARBIDE	M14X1.25	P3	12.8	12.85	TUMR014N4	4P	88	26	-	45	10.5	8	11	4	002	○
		P3	12.8	12.85	TUMR014N1	1.5P	88	26	-	45	10.5	8	11	4	002	○
LONG	M14X1	P3	13	13.09	TUMR014M4	4P	88	26	-	45	10.5	8	11	4	002	○
		P3	13	13.09	TUMR014M1	1.5P	88	26	-	45	10.5	8	11	4	002	○
HAND TAPS	M16X1.5	P3	14.5	14.6	TUMR01604	4P	95	26	-	48	12.5	10	13	4	002	○
		P3	14.5	14.6	TUMR01601	1.5P	95	26	-	48	12.5	10	13	4	002	○
EG (STI)	M16X1	P3	15	15.09	TUMR016M4	4P	95	26	-	48	12.5	10	13	4	002	○
		P3	15	15.09	TUMR016M1	1.5P	95	26	-	48	12.5	10	13	4	002	○
SPECIAL THREADS, GAUGES	M18X1.5	P4	16.5	16.6	TUMS01804	4P	100	33	-	51	14	11	14	4	002	○
		P4	16.5	16.6	TUMS01801	1.5P	100	33	-	51	14	11	14	4	002	○
THREAD MILLS	M20X1.5	P4	18.5	18.6	TUMS02004	4P	105	33	-	50	15	12	15	4	002	○
		P4	18.5	18.6	TUMS02001	1.5P	105	33	-	50	15	12	15	4	002	○
DIES	M22X1.5	P4	20.5	20.6	TUMS02204	4P	115	33	-	55	17	13	16	4	002	○
		P4	20.5	20.6	TUMS02201	1.5P	115	33	-	55	17	13	16	4	002	○
CENTER DRILLS	M24X1.5	P4	22.5	22.6	TUMS02404	4P	120	39	-	55	19	15	18	4	002	○
		P4	22.5	22.6	TUMS02401	1.5P	120	39	-	55	19	15	18	4	002	○
TECHNICAL INFO	M27X1.5	P4	25.5	25.6	TUMS02704	4P	130	39	-	60	20	15	18	4	002	○
		P4	25.5	25.6	TUMS02701	1.5P	130	39	-	60	20	15	18	4	002	○
	M30X1.5	P4	28.5	28.6	TUMS03004	4P	135	46	-	62	23	17	20	4	002	○
		P4	28.5	28.6	TUMS03001	1.5P	135	46	-	62	23	17	20	4	002	○
UNC																
JIS																
SPECIAL THREADS, GAUGES	1/4-20UNC	P2	5.1	5.19	TUMQU04N4	4P	62	15	26	33	6	4.5	7	3	001	○
		P2	5.1	5.19	TUMQU04N1	1.5P	62	15	26	33	6	4.5	7	3	001	○
THREAD MILLS	5/16-18UNC	P3	6.6	6.65	TUMRU0504	4P	70	19	-	36	6.2	5	8	3	002	○
		P3	6.6	6.65	TUMRU0501	1.5P	70	19	-	36	6.2	5	8	4	002	○
DIES	3/8-16UNC	P3	8	8.07	TUMRU06P4	4P	75	23	-	38	7	5.5	8	3	002	○
		P3	8	8.07	TUMRU06P1	1.5P	75	23	-	38	7	5.5	8	4	002	○
CENTER DRILLS	7/16-14UNC	P3	9.4	9.45	TUMRU07Q4	4P	82	26	-	42	8.5	6.5	9	3	002	○
		P3	9.4	9.45	TUMRU07Q1	1.5P	82	26	-	42	8.5	6.5	9	4	002	○
	1/2-13UNC	P3	10.9	10.91	TUMRU08R4	4P	88	26	-	45	10.5	8	11	3	002	○
		P3	10.9	10.91	TUMRU08R1	1.5P	88	26	-	45	10.5	8	11	4	002	○
	5/8-11UNC	P3	13.6	13.75	TUMRU10U4	4P	95	26	-	48	12.5	10	13	4	002	○
		P3	13.6	13.75	TUMRU10U1	1.5P	95	26	-	48	12.5	10	13	4	002	○

Technical info

UNC	TCTR (tolerance)	 Hole Ø (mm)	Hole Ø (mm)	Code	THCHT (chamfer)	LF (mm)	THL (mm)	LU (mm)	LS (mm)	DCON (mm)	K (mm)	LK (mm)	NOF	Type	Stock
JIS															
3/4-10UNC	P4	16.6	16.7	TUMSU12V4	4P	105	33	-	50	15	12	15	4	002	○
	P4	16.6	16.7	TUMSU12V1	1.5P	105	33	-	50	15	12	15	4	002	○
JIS															
1/4-28UNF	P2	5.5	5.53	TUMQU04K4	4P	62	15	26	33	6	4.5	7	3	001	○
	P2	5.5	5.53	TUMQU04K1	1.5P	62	15	26	33	6	4.5	7	3	001	○
5/16-24UNF	P2	6.9	6.97	TUMQU05M4	4P	70	19	-	36	6.2	5	8	3	002	○
	P2	6.9	6.97	TUMQU05M1	1.5P	70	19	-	36	6.2	5	8	4	002	○
3/8-24UNF	P2	8.5	8.57	TUMQU06M4	4P	75	23	-	38	7	5.5	8	3	002	○
	P2	8.5	8.57	TUMQU06M1	1.5P	75	23	-	38	7	5.5	8	4	002	○
7/16-20UNF	P3	9.9	9.96	TUMRU07N4	4P	82	26	-	42	8.5	6.5	9	3	002	○
	P3	9.9	9.96	TUMRU07N1	1.5P	82	26	-	42	8.5	6.5	9	4	002	○
1/2-20UNF	P3	11.5	11.54	TUMRU08N4	4P	88	26	-	45	10.5	8	11	3	002	○
	P3	11.5	11.54	TUMRU08N1	1.5P	88	26	-	45	10.5	8	11	4	002	○
5/8-18UNF	P3	14.5	14.6	TUMRU1004	4P	95	26	-	48	12.5	10	13	4	002	○
	P3	14.5	14.6	TUMRU1001	1.5P	95	26	-	48	12.5	10	13	4	002	○
3/4-16UNF	P3	17.5	17.59	TUMRU12P4	4P	105	33	-	50	15	12	15	4	002	○
	P3	17.5	17.59	TUMRU12P1	1.5P	105	33	-	50	15	12	15	4	002	○
JIS															
1/4W20	P3	5.1	5.13	TUMRW04N4	4P	62	15	26	33	6	4.5	7	3	001	○
	P3	5.1	5.13	TUMRW04N1	1.5P	62	15	26	33	6	4.5	7	3	001	○
5/16W18	P3	6.5	6.59	TUMRW0504	4P	70	19	-	36	6.2	5	8	3	002	○
	P3	6.5	6.59	TUMRW0501	1.5P	70	19	-	36	6.2	5	8	4	002	○
3/8W16	P3	8	8.02	TUMRW06P4	4P	75	23	-	38	7	5.5	8	3	002	○
	P3	8	8.02	TUMRW06P1	1.5P	75	23	-	38	7	5.5	8	4	002	○
7/16W14	P3	9.3	9.39	TUMRW07Q4	4P	82	26	-	42	8.5	6.5	9	3	002	○
	P3	9.3	9.39	TUMRW07Q1	1.5P	82	26	-	42	8.5	6.5	9	4	002	○
1/2W12	P3	10.6	10.7	TUMRW08S4	4P	88	26	-	45	10.5	8	11	3	002	○
	P3	10.6	10.7	TUMRW08S1	1.5P	88	26	-	45	10.5	8	11	4	002	○
5/8W11	P3	13.5	13.68	TUMRW10U4	4P	95	26	-	48	12.5	10	13	4	002	○
	P3	13.5	13.68	TUMRW10U1	1.5P	95	26	-	48	12.5	10	13	4	002	○
3/4W10	P4	16.5	16.63	TUMSW12V4	4P	105	33	-	50	15	12	15	4	002	○
	P4	16.5	16.63	TUMSW12V1	1.5P	105	33	-	50	15	12	15	4	002	○

Intro

SP

SL

PO

ST

JIS

ROLL

CARBIDE

LONG

HAND TAPS

EG (STI)

SPECIAL THREADS, GAUGES

THREAD MILLS

DIES

CENTER DRILLS

Technical info

Intro

LA-HT

MS Material Specific Series

SP Straight Fluted Taps for Die Cast Materials

SL



PO

Recommended Tapping Speeds Depending On Materials

ISO	Vc (m/min)
N1	5÷15 ★
N2	5÷15 ★
N3	5÷10 ☆
N4	5÷10 ☆

ST

JIS

★ 1st choice ☆ suitable

ROLL

CARBIDE

LONG

HAND TAPS

EG (STI)

SPECIAL THREADS, GAUGES

THREAD MILLS

DIES

CENTER DRILLS



Technical info

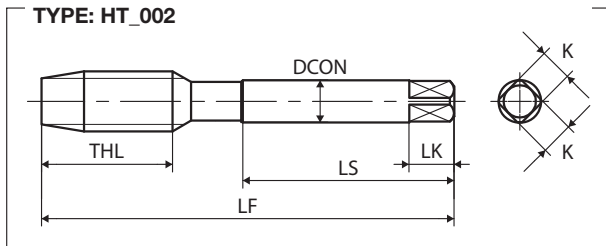
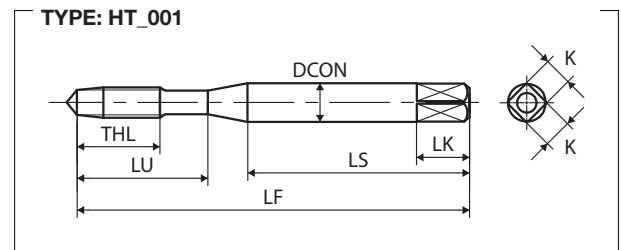
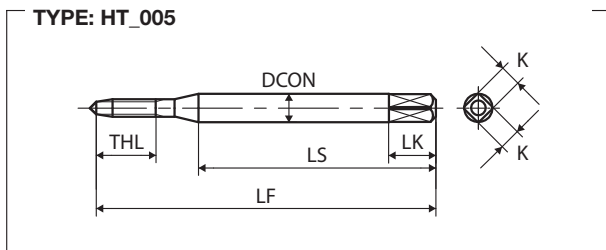

FEATURES

Material specific for blind and through hole application. Specific design and NI treatment allow stable and long life on Aluminium, Aluminium casting and die-casting. 1.5P chamfer for blind hole application, 5P chamfer for through hole application.



M	TCTR (tolerance)	 Hole Ø (mm)	Hole Ø (mm)	Code	THCHT (chamfer)	LF (mm)	THL (mm)	LU (mm)	LS (mm)	DCON (mm)	K (mm)	LK (mm)	NOF	Type	Stock
JIS															
M1.4X0.3	P2	1.1	1.13	TY1.4CQLEN5	5P	36	5.4	-	24	3	2.5	5	3	005	○
	P2	1.1	1.13	TY1.4CQLENA	1.5P	36	5.4	-	24	3	2.5	5	3	005	○
M1.6X0.35	P2	1.25	1.3	TY1.6DQLEN5	5P	36	6.3	-	24	3	2.5	5	3	005	○
	P2	1.25	1.3	TY1.6DQLENA	1.5P	36	6.3	-	24	3	2.5	5	3	005	○
M2X0.4	P2	1.6	1.65	TY2.0EQLEN5	5P	42	7.2	12	27	3	2.5	5	3	001	○
	P2	1.6	1.65	TY2.0EQLENA	1.5P	42	7.2	12	27	3	2.5	5	3	001	○
M2.3X0.4	P2	1.9	1.95	TY2.3EQLEN5	5P	42	7.2	12	27	3	2.5	5	3	001	○
	P2	1.9	1.95	TY2.3EQLENA	1.5P	42	7.2	12	27	3	2.5	5	3	001	○
M2.5X0.45	P2	2.1	2.11	TY2.5FQLEN5	5P	46	8.1	14	29	3	2.5	5	3	001	○
	P2	2.1	2.11	TY2.5FQLENA	1.5P	46	8.1	14	29	3	2.5	5	3	001	○
M2.6X0.45	P2	2.2	2.21	TY2.6FQLEN5	5P	46	8.1	14	29	3	2.5	5	3	001	○
	P2	2.2	2.21	TY2.6FQLENA	1.5P	46	8.1	14	29	3	2.5	5	3	001	○
M3X0.5	P2	2.5	2.56	TY3.0GQLEN5	5P	46	9	14	26	4	3.2	6	3	001	○
	P2	2.5	2.56	TY3.0GQLENA	1.5P	46	9	14	26	4	3.2	6	3	001	○
M3.5X0.6	P2	2.9	2.97	TY3.5HQLEN5	5P	52	11	16	29	5	4	7	3	001	○
	P2	2.9	2.97	TY3.5HQLENA	1.5P	52	11	16	29	5	4	7	3	001	○
M4X0.7	P3	3.3	3.38	TY4.0IRLEN5	5P	52	11	17	29	5	4	7	3	001	○
	P3	3.3	3.38	TY4.0IRLENA	1.5P	52	11	17	29	5	4	7	3	001	○
M5X0.8	P3	4.2	4.28	TY5.0KRLEN5	5P	60	13	22	33	5.5	4.5	7	3	001	○
	P3	4.2	4.28	TY5.0KRLENA	1.5P	60	13	22	33	5.5	4.5	7	3	001	○
M6X1	P3	5	5.09	TY6.0MRLEN5	5P	62	15	26	33	6	4.5	7	3	001	○
	P3	5	5.09	TY6.0MRLENA	1.5P	62	15	26	33	6	4.5	7	3	001	○
M8X1.25	P3	6.8	6.85	TY8.0NRLEN5	5P	70	19	-	36	6.2	5	8	3	002	○
	P3	6.8	6.85	TY8.0NRLENA	1.5P	70	19	-	36	6.2	5	8	3	002	○
M10X1.5	P4	8.5	8.6	TY0100SLEN5	5P	75	23	-	38	7	5.5	8	4	002	○
	P4	8.5	8.6	TY0100SLENA	1.5P	75	23	-	38	7	5.5	8	4	002	○
M12X1.75	P4	10.3	10.36	TY012PSLEN5	5P	82	26	-	42	8.5	6.5	9	4	002	○
	P4	10.3	10.36	TY012PSLENA	1.5P	82	26	-	42	8.5	6.5	9	4	002	○
M14X2	P4	12	12.12	TY014QSLEN5	5P	88	26	-	45	10.5	8	11	4	002	○
	P4	12	12.12	TY014QSLENA	1.5P	88	26	-	45	10.5	8	11	4	002	○
M16X2	P4	14	14.12	TY016QSLEN5	5P	95	26	-	48	12.5	10	13	4	002	○
	P4	14	14.12	TY016QSLENA	1.5P	95	26	-	48	12.5	10	13	4	002	○
M18X2.5	P5	15.5	15.63	TY018RTLEN5	5P	100	33	-	51	14	11	14	4	002	○
	P5	15.5	15.63	TY018RTLENA	1.5P	100	33	-	51	14	11	14	4	002	○
M20X2.5	P5	17.5	17.63	TY020RTLEN5	5P	105	33	-	50	15	12	15	4	002	○
	P5	17.5	17.63	TY020RTLENA	1.5P	105	33	-	50	15	12	15	4	002	○
M22X2.5	P5	19.5	19.63	TY022RTLENA	1.5P	115	33	-	55	17	13	16	4	002	○
M24X3	P5	21	21.13	TY024STLENA	1.5P	120	39	-	55	19	15	18	4	002	○
JIS															
MF	TCTR (tolerance)	 Hole Ø (mm)	Hole Ø (mm)	Code	THCHT (chamfer)	LF (mm)	THL (mm)	LU (mm)	LS (mm)	DCON (mm)	K (mm)	LK (mm)	NOF	Type	Stock
JIS															
M8X1	P3	7	7.09	TY8.0MRLEN5	5P	70	19	-	36	6.2	5	8	3	002	○
	P3	7	7.09	TY8.0MRLENA	1.5P	70	19	-	36	6.2	5	8	3	002	○
M10X1.25	P3	8.8	8.85	TY010NRLEN5	5P	75	23	-	38	7	5.5	8	4	002	○
	P3	8.8	8.85	TY010NRLENA	1.5P	75	23	-	38	7	5.5	8	4	002	○
M10X1	P3	9	9.09	TY010MRLEN5	5P	75	23	-	38	7	5.5	8	4	002	○
	P3	9	9.09	TY010MRLENA	1.5P	75	23	-	38	7	5.5	8	4	002	○

Intro

SP

SL

PO

ST

JIS

ROLL

CARBIDE

LONG

HAND
TAPS

EG (STI)

SPECIAL
THREADS,
GAUGESTHREAD
MILLS

DIES

CENTER
DRILLSTechnical
info

Straight Fluted Taps

Intro

SP

SL

PO

ST

JIS

ROLL

CARBIDE

LONG

HAND TAPS

EG (STI)

SPECIAL THREADS, GAUGES

THREAD MILLS

DIES

CENTER DRILLS

Technical info

MF	TCTR (tolerance)	 Hole Ø (mm)	Hole Ø (mm)	Code	THCHT (chamfer)	LF (mm)	THL (mm)	LU (mm)	LS (mm)	DCON (mm)	K (mm)	LK (mm)	NOF	Type	Stock
JIS															
M12X1.5	P4	10.5	10.6	TY0120SLEN5	5P	82	26	-	42	8.5	6.5	9	4	002	○
	P4	10.5	10.6	TY0120SLENA	1.5P	82	26	-	42	8.5	6.5	9	4	002	○
M12X1.25	P4	10.8	10.85	TY012NSLEN5	5P	82	26	-	42	8.5	6.5	9	4	002	○
	P4	10.8	10.85	TY012NSLENA	1.5P	82	26	-	42	8.5	6.5	9	4	002	○
M12X1	P3	11	11.09	TY012MRELEN5	5P	82	26	-	42	8.5	6.5	9	4	002	○
	P3	11	11.09	TY012MRELENA	1.5P	82	26	-	42	8.5	6.5	9	4	002	○
M14X1.5	P4	12.5	12.6	TY0140SLEN5	5P	88	26	-	45	10.5	8	11	4	002	○
	P4	12.5	12.6	TY0140SLENA	1.5P	88	26	-	45	10.5	8	11	4	002	○
M16X1.5	P4	14.5	14.6	TY0160SLEN5	5P	95	26	-	48	12.5	10	13	4	002	○
	P4	14.5	14.6	TY0160SLENA	1.5P	95	26	-	48	12.5	10	13	4	002	○
M18X1.5	P4	16.5	16.6	TY0180SLEN5	5P	100	33	-	51	14	11	14	4	002	○
	P4	16.5	16.6	TY0180SLENA	1.5P	100	33	-	51	14	11	14	4	002	○
M20X1.5	P4	18.5	18.6	TY0200SLEN5	5P	105	33	-	50	15	12	15	4	002	○
	P4	18.5	18.6	TY0200SLENA	1.5P	105	33	-	50	15	12	15	4	002	○
M22X1.5	P4	20.5	20.6	TY0220SLENA	1.5P	115	33	-	55	17	13	16	4	002	○
M24X1.5	P4	22.5	22.6	TY0240SLENA	1.5P	120	39	-	55	19	15	18	4	002	○

MG-HT

MS Material Specific Series

Straight Fluted Taps with Short Chamfer for Magnesium Alloy Castings



FEATURES

Material specific for blind and through hole application.
Specific design for Magnesium alloys.
1P extra short chamfer length.

Recommended Tapping Speeds Depending On Materials

ISO Vc (m/min)

N1 5÷15 ★

N2 5÷15 ★

★ 1st choice ☆ suitable

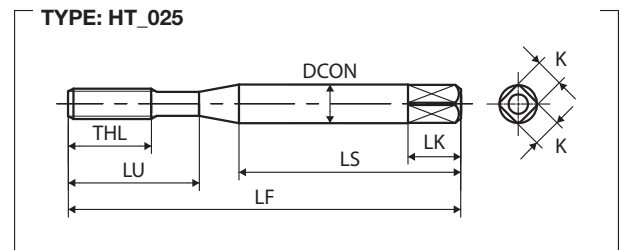
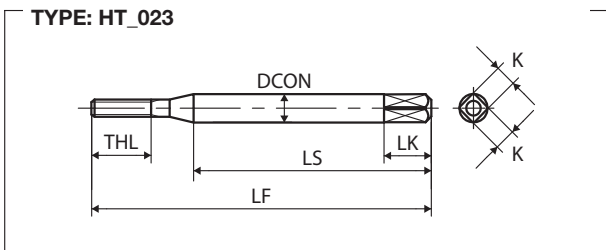

M	TCTR (tolerance)	Hole Ø (mm)	Hole Ø (mm)	Code	THCHT (chamfer)	LF (mm)	THL (mm)	LU (mm)	LS (mm)	DCON (mm)	K (mm)	LK (mm)	NOF	Type	Stock
JIS															
M1.4X0.3	P2	1.1	1.13	TMGMQ1.4C1	1P	36	5.4	-	24	3	2.5	5	3	023	○
M1.6X0.35	P2	1.25	1.3	TMGMQ1.6D1	1P	36	6.3	-	24	3	2.5	5	3	023	○
M1.7X0.35	P2	1.35	1.4	TMGMQ1.7D1	1P	36	6.3	-	24	3	2.5	5	3	023	○
M2X0.4	P2	1.6	1.65	TMGMQ2.0E1	1P	42	7.2	12	27	3	2.5	5	3	025	○
M2.5X0.45	P2	2.1	2.11	TMGMQ2.5F1	1P	46	8.1	14	29	3	2.5	5	3	025	○
M2.6X0.45	P2	2.2	2.21	TMGMQ2.6F1	1P	46	8.1	14	29	3	2.5	5	3	025	○
M3X0.5	P2	2.5	2.56	TMGMQ3.0G1	1P	46	9	14	26	4	3.2	6	3	025	○

Intro

SP

SL

PO

ST

JIS

ROLL

CARBIDE

LONG

HAND TAPS

EG (STI)

SPECIAL THREADS, GAUGES

THREAD MILLS

DIES

CENTER DRILLS

Technical info

Intro

PL1

MS Material Specific Series

Straight Fluted Taps for Thermosetting Plastics



SP

SL



PO

Recommended Tapping Speeds Depending On Materials

ISO	Vc (m/min)
N5	5÷10 ★

★ 1st choice ☆ suitable

ST

JIS

ROLL

CARBIDE

LONG

HAND TAPS

EG (STI)

SPECIAL THREADS, GAUGES

THREAD MILLS

DIES

CENTER DRILLS

Technical info

FEATURES

Material specific for blind and through hole application. Specific design and NI treatment for Thermosetting Plastics.

TYPE: HT_001

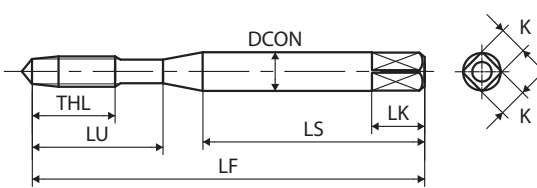

TYPE: HT_002

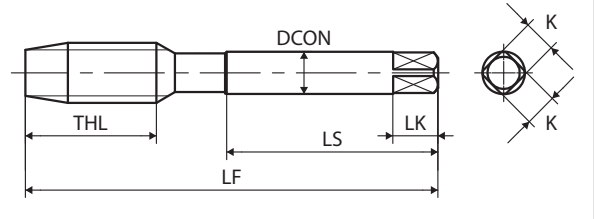

M	TCTR (tolerance)	 Hole Ø (mm)	Hole Ø (mm)	Code	THCHT (chamfer)	LF (mm)	THL (mm)	LU (mm)	LS (mm)	DCON (mm)	K (mm)	LK (mm)	NOF	Type	Stock
JIS															
M2X0.4	P4	1.6	1.65	TPLM2.0E3	3P	42	7.2	12	27	3	2.5	5	3	001	○
M2.3X0.4	P4	1.9	1.95	TPLM2.3E3	3P	42	7.2	12	27	3	2.5	5	3	001	○
M2.5X0.45	P4	2.1	2.11	TPLM2.5F3	3P	46	8.1	14	29	3	2.5	5	3	001	○
M2.6X0.45	P4	2.2	2.21	TPLM2.6F3	3P	46	8.1	14	29	3	2.5	5	3	001	○
M3X0.5	P5	2.5	2.56	TPLM3.0G3	3P	46	9	14	26	4	3.2	6	4	001	○
M3.5X0.6	P5	2.9	2.97	TPLM3.5H3	3P	52	11	16	29	5	4	7	4	001	○
M4X0.7	P5	3.3	3.38	TPLM4.0I3	3P	52	11	17	29	5	4	7	4	001	○
M5X0.8	P5	4.2	4.28	TPLM5.0K3	3P	60	13	22	33	5.5	4.5	7	4	001	○
M6X1	P5	5	5.09	TPLM6.0M3	3P	62	15	26	33	6	4.5	7	4	001	○
M8X1.25	P6	6.8	6.85	TPLM8.0N3	3P	70	19	-	36	6.2	5	8	4	002	○

Intro

SP

SL

PO

ST

JIS

ROLL

CARBIDE

LONG

HAND
TAPS

EG (STI)

SPECIAL
THREADS,
GAUGESTHREAD
MILLS

DIES

CENTER
DRILLSTechnical
info

Straight Fluted Taps

Intro

HT

GP General Purpose Series

Straight Fluted Taps



SP

SL



PO

Recommended Tapping Speeds Depending On Materials

ISO	Vc (m/min)	ISO	Vc (m/min)	ISO	Vc (m/min)
P1	5±10 ☆	K1	5±10 ☆	N2	5±10 ☆
P2	5±10 ★	K2	5±10 ☆	N3	5±10 ☆
P3	5±10 ☆	K3	5±10 ☆	N4	5±10 ☆
P4	5±10 ☆				

★ 1st choice ☆ suitable

ST

ANSI

ROLL

CARBIDE

LONG

HAND TAPS

EG (STI)

SPECIAL THREADS, GAUGES

THREAD MILLS

DIES

CENTER DRILLS

Technical info

FEATURES

General purpose for blind and through hole application. For steel application at low cutting speed, also suitable for cast iron and non-ferrous materials.

TYPE: US_004

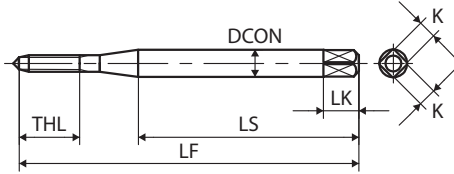

TYPE: US_005

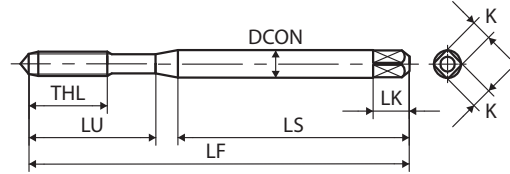

TYPE: US_006

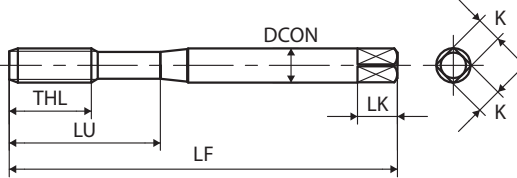

TYPE: US_007

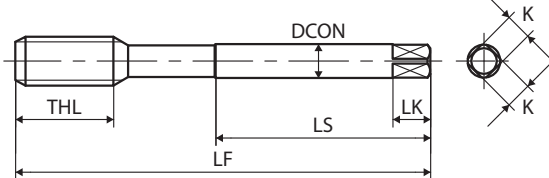

UNC	TCTR (tolerance)	 Hole Ø (mm)	Hole Ø (mm)	Code	THCHT (chamfer)	LF (inch)	THL (inch)	LU (inch)	LS (inch)	DCON (inch)	K (inch)	LK (inch)	NOF	Type	Stock
ANSI															
No.1-64UNC	GH1	1.54	1.55	TSUN1D1NEB5	5P	1.772	0.275	-	1.161	0.141	0.11	0.187	2	004	○
	GH1	1.54	1.55	TSUN1D1NEBA	1.5P	1.772	0.275	-	1.161	0.141	0.11	0.187	2	004	○
	GH2	1.54	1.55	TSUN1D2NEB5	5P	1.772	0.275	-	1.161	0.141	0.11	0.187	2	004	○
	GH2	1.54	1.55	TSUN1D2NEBA	1.5P	1.772	0.275	-	1.161	0.141	0.11	0.187	2	004	○
No.2-56UNC	GH1	1.8	1.83	TSUN2E1NEB5	5P	1.772	0.314	-	1.161	0.141	0.11	0.187	3	004	○
	GH1	1.8	1.83	TSUN2E1NEBA	1.5P	1.772	0.314	-	1.161	0.141	0.11	0.187	3	004	○
	GH2	1.8	1.83	TSUN2E2NEB5	5P	1.772	0.314	-	1.161	0.141	0.11	0.187	3	004	○
	GH2	1.8	1.83	TSUN2E2NEBA	1.5P	1.772	0.314	-	1.161	0.141	0.11	0.187	3	004	○
No.3-48UNC	GH1	2.09	2.1	TSUN3F1NEB5	5P	2.205	0.354	0.669	1.28	0.141	0.11	0.187	3	005	○
	GH1	2.09	2.1	TSUN3F1NEBA	1.5P	2.205	0.354	0.669	1.28	0.141	0.11	0.187	3	005	○
	GH2	2.09	2.1	TSUN3F2NEB5	5P	2.205	0.354	0.669	1.28	0.141	0.11	0.187	3	005	○
	GH2	2.09	2.1	TSUN3F2NEBA	1.5P	2.205	0.354	0.669	1.28	0.141	0.11	0.187	3	005	○
No.4-40UNC	GH2	2.3	2.33	TSUN4H2NEB5	5P	2.205	0.354	0.709	1.28	0.141	0.11	0.187	3	005	○
	GH2	2.3	2.33	TSUN4H2NEBA	1.5P	2.205	0.354	0.709	1.28	0.141	0.11	0.187	3	005	○
	GH3	2.3	2.33	TSUN4H3NEB5	5P	2.205	0.354	0.709	1.28	0.141	0.11	0.187	3	005	○
	GH3	2.3	2.33	TSUN4H3NEBA	1.5P	2.205	0.354	0.709	1.28	0.141	0.11	0.187	3	005	○
No.5-40UNC	GH2	2.6	2.64	TSUN5H2NEB5	5P	2.205	0.433	0.768	1.358	0.141	0.11	0.187	3	005	○
	GH2	2.6	2.64	TSUN5H2NEBA	1.5P	2.205	0.433	0.768	1.358	0.141	0.11	0.187	3	005	○
	GH3	2.6	2.64	TSUN5H3NEB5	5P	2.205	0.433	0.768	1.358	0.141	0.11	0.187	3	005	○
	GH3	2.6	2.64	TSUN5H3NEBA	1.5P	2.205	0.433	0.768	1.358	0.141	0.11	0.187	3	005	○
No.6-32UNC	GH2	2.8	2.83	TSUN6J2NEB5	5P	2.205	0.433	0.787	1.358	0.141	0.11	0.187	3	005	○
	GH2	2.8	2.83	TSUN6J2NEBA	1.5P	2.205	0.433	0.787	1.358	0.141	0.11	0.187	3	005	○
	GH3	2.8	2.83	TSUN6J3NEB5	5P	2.205	0.433	0.787	1.358	0.141	0.11	0.187	3	005	○
	GH3	2.8	2.83	TSUN6J3NEBA	1.5P	2.205	0.433	0.787	1.358	0.141	0.11	0.187	3	005	○
No.8-32UNC	GH2	3.4	3.47	TSUN8J2NEB5	5P	2.48	0.512	0.827	1.535	0.168	0.131	0.25	4	005	○
	GH2	3.4	3.47	TSUN8J2NEBA	1.5P	2.48	0.512	0.827	1.535	0.168	0.131	0.25	4	005	○
	GH3	3.4	3.47	TSUN8J3NEB5	5P	2.48	0.512	0.827	1.535	0.168	0.131	0.25	4	005	○
	GH3	3.4	3.47	TSUN8J3NEBA	1.5P	2.48	0.512	0.827	1.535	0.168	0.131	0.25	4	005	○
No.10-24UNC	GH2	3.89	3.9	TSUNAM2NEB5	5P	2.756	0.551	0.984	1.654	0.194	0.152	0.25	4	005	○
	GH2	3.89	3.9	TSUNAM2NEBA	1.5P	2.756	0.551	0.984	1.654	0.194	0.152	0.25	4	005	○
	GH3	3.89	3.9	TSUNAM3NEB5	5P	2.756	0.551	0.984	1.654	0.194	0.152	0.25	4	005	○
	GH3	3.89	3.9	TSUNAM3NEBA	1.5P	2.756	0.551	0.984	1.654	0.194	0.152	0.25	4	005	○
No.12-24UNC	GH2	4.5	4.53	TSUNCM2NEB5	5P	3.15	0.591	0.984	1.929	0.22	0.165	0.281	4	005	○
	GH2	4.5	4.53	TSUNCM2NEBA	1.5P	3.15	0.591	0.984	1.929	0.22	0.165	0.281	4	005	○
	GH3	4.5	4.53	TSUNCM3NEB5	5P	3.15	0.591	0.984	1.929	0.22	0.165	0.281	4	005	○
	GH3	4.5	4.53	TSUNCM3NEBA	1.5P	3.15	0.591	0.984	1.929	0.22	0.165	0.281	4	005	○
1/4-20UNC	GH3	5.1	5.19	TSU04N3NEB5	5P	3.15	0.591	1.181	1.713	0.255	0.191	0.312	4	005	○
	GH3	5.1	5.19	TSU04N3NEBA	1.5P	3.15	0.591	1.181	1.713	0.255	0.191	0.312	4	005	○
	GH4	5.1	5.19	TSU04N4NEB5	5P	3.15	0.591	1.181	1.713	0.255	0.191	0.312	4	005	○
	GH4	5.1	5.19	TSU04N4NEBA	1.5P	3.15	0.591	1.181	1.713	0.255	0.191	0.312	4	005	○
	GH5	5.1	5.19	TSU04N5NEB5	5P	3.15	0.591	1.181	1.713	0.255	0.191	0.312	4	005	○
GH5	5.1	5.19	TSU04N5NEBA	1.5P	3.15	0.591	1.181	1.713	0.255	0.191	0.312	4	005	○	

The most suitable GH tap class to cut accurate 2B, 3B (UNJ) and 2B oversized internal threads tolerance, depends on application conditions and work-piece materials. Yamawa GH class system offers a wide range of alternative tap classes allowing each customer to select the most suitable one according to application requirement. Check page 673 of Technical info for full details.

Straight Fluted Taps

Intro

SP

SL

PO

ST

ANSI

ROLL

CARBIDE

LONG

HAND TAPS

EG (STI)

SPECIAL THREADS, GAUGES

THREAD MILLS

DIES

CENTER DRILLS

Technical info

UNC	TCTR (tolerance)	Hole Ø (mm)	Hole Ø (mm)	Code	THCHT (chamfer)	LF (inch)	THL (inch)	LU (inch)	LS (inch)	DCON (inch)	K (inch)	LK (inch)	NOF	Type	Stock
ANSI															
5/16-18UNC	GH3	6.6	6.65	TSU0503NEB5	5P	3.543	0.748	1.378	1.831	0.318	0.238	0.375	4	006	○
	GH3	6.6	6.65	TSU0503NEBA	1.5P	3.543	0.748	1.378	1.831	0.318	0.238	0.375	4	006	○
	GH4	6.6	6.65	TSU0504NEB5	5P	3.543	0.748	1.378	1.831	0.318	0.238	0.375	4	006	○
	GH4	6.6	6.65	TSU0504NEBA	1.5P	3.543	0.748	1.378	1.831	0.318	0.238	0.375	4	006	○
	GH5	6.6	6.65	TSU0505NEB5	5P	3.543	0.748	1.378	1.831	0.318	0.238	0.375	4	006	○
	GH5	6.6	6.65	TSU0505NEBA	1.5P	3.543	0.748	1.378	1.831	0.318	0.238	0.375	4	006	○
3/8-16UNC	GH3	8	8.07	TSU06P3NEB5	5P	3.937	0.906	1.535	2.028	0.381	0.286	0.437	4	006	○
	GH3	8	8.07	TSU06P3NEBA	1.5P	3.937	0.906	1.535	2.028	0.381	0.286	0.437	4	006	○
	GH5	8	8.07	TSU06P5NEB5	5P	3.937	0.906	1.535	2.028	0.381	0.286	0.437	4	006	○
	GH5	8	8.07	TSU06P5NEBA	1.5P	3.937	0.906	1.535	2.028	0.381	0.286	0.437	4	006	○
7/16-14UNC	GH4	9.4	9.45	TSU07Q4NEB5	5P	3.937	0.906	-	2.008	0.323	0.242	0.406	4	007	○
	GH4	9.4	9.45	TSU07Q4NEBA	1.5P	3.937	0.906	-	2.008	0.323	0.242	0.406	4	007	○
	GH5	9.4	9.45	TSU07Q5NEB5	5P	3.937	0.906	-	2.008	0.323	0.242	0.406	4	007	○
	GH5	9.4	9.45	TSU07Q5NEBA	1.5P	3.937	0.906	-	2.008	0.323	0.242	0.406	4	007	○
1/2-13UNC	GH3	10.9	10.91	TSU08R3NEB5	5P	4.331	1.024	-	2.205	0.367	0.275	0.437	4	007	○
	GH3	10.9	10.91	TSU08R3NEBA	1.5P	4.331	1.024	-	2.205	0.367	0.275	0.437	4	007	○
	GH4	10.9	10.91	TSU08R4NEB5	5P	4.331	1.024	-	2.205	0.367	0.275	0.437	4	007	○
	GH4	10.9	10.91	TSU08R4NEBA	1.5P	4.331	1.024	-	2.205	0.367	0.275	0.437	4	007	○
	GH5	10.9	10.91	TSU08R5NEB5	5P	4.331	1.024	-	2.205	0.367	0.275	0.437	4	007	○
	GH5	10.9	10.91	TSU08R5NEBA	1.5P	4.331	1.024	-	2.205	0.367	0.275	0.437	4	007	○
9/16-12UNC	GH3	12.2	12.33	TSU09S3NEB5	5P	4.331	1.024	-	2.205	0.429	0.322	0.5	4	007	○
	GH3	12.2	12.33	TSU09S3NEBA	1.5P	4.331	1.024	-	2.205	0.429	0.322	0.5	4	007	○
	GH4	12.2	12.33	TSU09S4NEB5	5P	4.331	1.024	-	2.205	0.429	0.322	0.5	4	007	○
	GH4	12.2	12.33	TSU09S4NEBA	1.5P	4.331	1.024	-	2.205	0.429	0.322	0.5	4	007	○
	GH5	12.2	12.33	TSU09S5NEB5	5P	4.331	1.024	-	2.205	0.429	0.322	0.5	4	007	○
	GH5	12.2	12.33	TSU09S5NEBA	1.5P	4.331	1.024	-	2.205	0.429	0.322	0.5	4	007	○
5/8-11UNC	GH3	13.6	13.75	TSU10U3NEB5	5P	4.331	1.024	-	2.205	0.48	0.36	0.562	4	007	○
	GH3	13.6	13.75	TSU10U3NEBA	1.5P	4.331	1.024	-	2.205	0.48	0.36	0.562	4	007	○
	GH4	13.6	13.75	TSU10U4NEB5	5P	4.331	1.024	-	2.205	0.48	0.36	0.562	4	007	○
	GH4	13.6	13.75	TSU10U4NEBA	1.5P	4.331	1.024	-	2.205	0.48	0.36	0.562	4	007	○
	GH5	13.6	13.75	TSU10U5NEB5	5P	4.331	1.024	-	2.205	0.48	0.36	0.562	4	007	○
	GH5	13.6	13.75	TSU10U5NEBA	1.5P	4.331	1.024	-	2.205	0.48	0.36	0.562	4	007	○
3/4-10UNC	GH6	13.6	13.75	TSU10U6NEB5	5P	4.331	1.024	-	2.205	0.48	0.36	0.562	4	007	○
	GH6	13.6	13.75	TSU10U6NEBA	1.5P	4.331	1.024	-	2.205	0.48	0.36	0.562	4	007	○
	GH3	16.6	16.7	TSU12V3NEB5	5P	4.921	1.299	-	2.52	0.59	0.442	0.687	4	007	○
	GH3	16.6	16.7	TSU12V3NEBA	1.5P	4.921	1.299	-	2.52	0.59	0.442	0.687	4	007	○
	GH5	16.6	16.7	TSU12V5NEB5	5P	4.921	1.299	-	2.52	0.59	0.442	0.687	4	007	○
	GH5	16.6	16.7	TSU12V5NEBA	1.5P	4.921	1.299	-	2.52	0.59	0.442	0.687	4	007	○
7/8-9UNC	GH6	16.6	16.7	TSU12V6NEB5	5P	4.921	1.299	-	2.52	0.59	0.442	0.687	4	007	○
	GH6	16.6	16.7	TSU12V6NEBA	1.5P	4.921	1.299	-	2.52	0.59	0.442	0.687	4	007	○
	GH5	19.6	19.61	TSU14W5NEB5	5P	5.512	1.299	-	2.795	0.697	0.523	0.75	4	007	○
	GH5	19.6	19.61	TSU14W5NEBA	1.5P	5.512	1.299	-	2.795	0.697	0.523	0.75	4	007	○
	GH6	19.6	19.61	TSU14W6NEB5	5P	5.512	1.299	-	2.795	0.697	0.523	0.75	4	007	○
	GH6	19.6	19.61	TSU14W6NEBA	1.5P	5.512	1.299	-	2.795	0.697	0.523	0.75	4	007	○

UNC	TCTR (tolerance)	\varnothing (mm)	Hole \varnothing (mm)	Code	THCHT (chamfer)	LF (inch)	THL (inch)	LU (inch)	LS (inch)	DCON (inch)	K (inch)	LK (inch)	NOF	Type	Stock
ANSI															
1-8UNC	GH4	22.3	22.45	TSU16X4NEB5	5P	6.299	1.457	-	3.228	0.8	0.6	0.812	4	007	○
	GH4	22.3	22.45	TSU16X4NEBA	1.5P	6.299	1.457	-	3.228	0.8	0.6	0.812	4	007	○
	GH5	22.3	22.45	TSU16X5NEB5	5P	6.299	1.457	-	3.228	0.8	0.6	0.812	4	007	○
	GH5	22.3	22.45	TSU16X5NEBA	1.5P	6.299	1.457	-	3.228	0.8	0.6	0.812	4	007	○
	GH6	22.3	22.45	TSU16X6NEB5	5P	6.299	1.457	-	3.228	0.8	0.6	0.812	4	007	○
	GH6	22.3	22.45	TSU16X6NEBA	1.5P	6.299	1.457	-	3.228	0.8	0.6	0.812	4	007	○
	GH7	22.3	22.45	TSU16X7NEB5	5P	6.299	1.457	-	3.228	0.8	0.6	0.812	4	007	○
	GH7	22.3	22.45	TSU16X7NEBA	1.5P	6.299	1.457	-	3.228	0.8	0.6	0.812	4	007	○
1 1/8-7UNC	GH6	25	25.17	TSU18Y6NEB5	5P	7.087	1.732	-	3.622	0.896	0.672	0.875	4	007	○
	GH6	25	25.17	TSU18Y6NEBA	1.5P	7.087	1.732	-	3.622	0.896	0.672	0.875	4	007	○
	GH7	25	25.17	TSU18Y7NEB5	5P	7.087	1.732	-	3.622	0.896	0.672	0.875	4	007	○
	GH7	25	25.17	TSU18Y7NEBA	1.5P	7.087	1.732	-	3.622	0.896	0.672	0.875	4	007	○
1 1/4-7UNC	GH6	28.2	28.35	TSU20Y6NEB5	5P	7.087	1.929	-	3.622	1.021	0.766	1	4	007	○
	GH6	28.2	28.35	TSU20Y6NEBA	1.5P	7.087	1.929	-	3.622	1.021	0.766	1	4	007	○
	GH8	28.2	28.35	TSU20Y8NEB5	5P	7.087	1.929	-	3.622	1.021	0.766	1	4	007	○
	GH8	28.2	28.35	TSU20Y8NEBA	1.5P	7.087	1.929	-	3.622	1.021	0.766	1	4	007	○
1 3/8-6UNC	GH6	30.8	30.92	TSU22Z6NEB5	5P	7.874	2.165	-	4.016	1.108	0.831	1.062	4	007	○
	GH6	30.8	30.92	TSU22Z6NEBA	1.5P	7.874	2.165	-	4.016	1.108	0.831	1.062	4	007	○
	GH8	30.8	30.92	TSU22Z8NEB5	5P	7.874	2.165	-	4.016	1.108	0.831	1.062	4	007	○
	GH8	30.8	30.92	TSU22Z8NEBA	1.5P	7.874	2.165	-	4.016	1.108	0.831	1.062	4	007	○
1 1/2-6UNC	GH6	34	34.1	TSU24Z6NEB5	5P	7.874	2.323	-	4.016	1.233	0.925	1.125	4	007	○
	GH6	34	34.1	TSU24Z6NEBA	1.5P	7.874	2.323	-	4.016	1.233	0.925	1.125	4	007	○
	GH8	34	34.1	TSU24Z8NEB5	5P	7.874	2.323	-	4.016	1.233	0.925	1.125	4	007	○
	GH8	34	34.1	TSU24Z8NEBA	1.5P	7.874	2.323	-	4.016	1.233	0.925	1.125	4	007	○
UNF	TCTR (tolerance)	\varnothing (mm)	Hole \varnothing (mm)	Code	THCHT (chamfer)	LF (inch)	THL (inch)	LU (inch)	LS (inch)	DCON (inch)	K (inch)	LK (inch)	NOF	Type	Stock
ANSI															
No.0-80UNF	GH1	1.25	1.27	TSUN0B1NEB5	5P	1.772	0.236	-	1.161	0.141	0.11	0.187	2	004	○
	GH1	1.25	1.27	TSUN0B1NEBA	1.5P	1.772	0.236	-	1.161	0.141	0.11	0.187	2	004	○
	GH2	1.25	1.27	TSUN0B2NEB5	5P	1.772	0.236	-	1.161	0.141	0.11	0.187	2	004	○
	GH2	1.25	1.27	TSUN0B2NEBA	1.5P	1.772	0.236	-	1.161	0.141	0.11	0.187	2	004	○
No.1-72UNF	GH1	1.55	1.58	TSUN1C1NEB5	5P	1.772	0.275	-	1.161	0.141	0.11	0.187	2	004	○
	GH1	1.55	1.58	TSUN1C1NEBA	1.5P	1.772	0.275	-	1.161	0.141	0.11	0.187	2	004	○
	GH2	1.55	1.58	TSUN1C2NEB5	5P	1.772	0.275	-	1.161	0.141	0.11	0.187	2	004	○
	GH2	1.55	1.58	TSUN1C2NEBA	1.5P	1.772	0.275	-	1.161	0.141	0.11	0.187	2	004	○
No.2-64UNF	GH1	1.85	1.87	TSUN2D1NEB5	5P	1.772	0.314	-	1.161	0.141	0.11	0.187	3	004	○
	GH1	1.85	1.87	TSUN2D1NEBA	1.5P	1.772	0.314	-	1.161	0.141	0.11	0.187	3	004	○
	GH2	1.85	1.87	TSUN2D2NEB5	5P	1.772	0.314	-	1.161	0.141	0.11	0.187	3	004	○
	GH2	1.85	1.87	TSUN2D2NEBA	1.5P	1.772	0.314	-	1.161	0.141	0.11	0.187	3	004	○
No.3-56UNF	GH1	2.1	2.15	TSUN3E1NEB5	5P	2.205	0.354	0.669	1.28	0.141	0.11	0.187	3	005	○
	GH1	2.1	2.15	TSUN3E1NEBA	1.5P	2.205	0.354	0.669	1.28	0.141	0.11	0.187	3	005	○
	GH2	2.1	2.15	TSUN3E2NEB5	5P	2.205	0.354	0.669	1.28	0.141	0.11	0.187	3	005	○
	GH2	2.1	2.15	TSUN3E2NEBA	1.5P	2.205	0.354	0.669	1.28	0.141	0.11	0.187	3	005	○
No.4-48UNF	GH1	2.4	2.41	TSUN4F1NEB5	5P	2.205	0.354	0.709	1.28	0.141	0.11	0.187	3	005	○
	GH1	2.4	2.41	TSUN4F1NEBA	1.5P	2.205	0.354	0.709	1.28	0.141	0.11	0.187	3	005	○
	GH2	2.4	2.41	TSUN4F2NEB5	5P	2.205	0.354	0.709	1.28	0.141	0.11	0.187	3	005	○
	GH2	2.4	2.41	TSUN4F2NEBA	1.5P	2.205	0.354	0.709	1.28	0.141	0.11	0.187	3	005	○

The most suitable GH tap class to cut accurate 2B, 3B (UNJ) and 2B oversized internal threads tolerance, depends on application conditions and work-piece materials. Yamawa GH class system offers a wide range of alternative tap classes allowing each customer to select the most suitable one according to application requirement. Check page 673 of Technical info for full details.

Straight Fluted Taps

Intro

	UNF	TCTR (tolerance)	∅ (mm)	Hole ∅ (mm)	Code	THCHT (chamfer)	LF (inch)	THL (inch)	LU (inch)	LS (inch)	DCON (inch)	K (inch)	LK (inch)	NOF	Type	Stock
	ANSI															
SP	No.5-44UNF	GH1	2.7	2.69	TSUN5G1NEB5	5P	2.205	0.433	0.768	1.358	0.141	0.11	0.187	3	005	○
		GH1	2.7	2.69	TSUN5G1NEBA	1.5P	2.205	0.433	0.768	1.358	0.141	0.11	0.187	3	005	○
GH2		2.7	2.69	TSUN5G2NEB5	5P	2.205	0.433	0.768	1.358	0.141	0.11	0.187	3	005	○	
GH2		2.7	2.69	TSUN5G2NEBA	1.5P	2.205	0.433	0.768	1.358	0.141	0.11	0.187	3	005	○	
SL		GH3	2.7	2.69	TSUN5G3NEB5	5P	2.205	0.433	0.768	1.358	0.141	0.11	0.187	3	005	○
GH3		2.7	2.69	TSUN5G3NEBA	1.5P	2.205	0.433	0.768	1.358	0.141	0.11	0.187	3	005	○	
PO	No.6-40UNF	GH2	2.9	2.97	TSUN6H2NEB5	5P	2.205	0.433	0.787	1.358	0.141	0.11	0.187	3	005	○
		GH2	2.9	2.97	TSUN6H2NEBA	1.5P	2.205	0.433	0.787	1.358	0.141	0.11	0.187	3	005	○
GH3		2.9	2.97	TSUN6H3NEB5	5P	2.205	0.433	0.787	1.358	0.141	0.11	0.187	3	005	○	
GH3		2.9	2.97	TSUN6H3NEBA	1.5P	2.205	0.433	0.787	1.358	0.141	0.11	0.187	3	005	○	
ST ANSI	No.8-36UNF	GH2	3.5	3.55	TSUN8I2NEB5	5P	2.48	0.512	0.827	1.535	0.168	0.131	0.25	4	005	○
		GH2	3.5	3.55	TSUN8I2NEBA	1.5P	2.48	0.512	0.827	1.535	0.168	0.131	0.25	4	005	○
GH3		3.5	3.55	TSUN8I3NEB5	5P	2.48	0.512	0.827	1.535	0.168	0.131	0.25	4	005	○	
GH3		3.5	3.55	TSUN8I3NEBA	1.5P	2.48	0.512	0.827	1.535	0.168	0.131	0.25	4	005	○	
ROLL	No.10-32UNF	GH2	4.1	4.12	TSUNAJ2NEB5	5P	2.756	0.551	0.984	1.654	0.194	0.152	0.25	4	005	○
		GH2	4.1	4.12	TSUNAJ2NEBA	1.5P	2.756	0.551	0.984	1.654	0.194	0.152	0.25	4	005	○
GH3		4.1	4.12	TSUNAJ3NEB5	5P	2.756	0.551	0.984	1.654	0.194	0.152	0.25	4	005	○	
GH3		4.1	4.12	TSUNAJ3NEBA	1.5P	2.756	0.551	0.984	1.654	0.194	0.152	0.25	4	005	○	
CARBIDE	No.12-28UNF	GH2	4.6	4.67	TSUNCK2NEB5	5P	3.15	0.591	0.984	1.929	0.22	0.165	0.281	4	005	○
		GH2	4.6	4.67	TSUNCK2NEBA	1.5P	3.15	0.591	0.984	1.929	0.22	0.165	0.281	4	005	○
GH3		4.6	4.67	TSUNCK3NEB5	5P	3.15	0.591	0.984	1.929	0.22	0.165	0.281	4	005	○	
GH3		4.6	4.67	TSUNCK3NEBA	1.5P	3.15	0.591	0.984	1.929	0.22	0.165	0.281	4	005	○	
LONG	1/4-28UNF	GH2	5.5	5.53	TSU04K2NEB5	5P	3.15	0.591	1.181	1.713	0.255	0.191	0.312	4	005	○
		GH2	5.5	5.53	TSU04K2NEBA	1.5P	3.15	0.591	1.181	1.713	0.255	0.191	0.312	4	005	○
GH3		5.5	5.53	TSU04K3NEB5	5P	3.15	0.591	1.181	1.713	0.255	0.191	0.312	4	005	○	
GH3		5.5	5.53	TSU04K3NEBA	1.5P	3.15	0.591	1.181	1.713	0.255	0.191	0.312	4	005	○	
HAND TAPS		GH4	5.5	5.53	TSU04K4NEB5	5P	3.15	0.591	1.181	1.713	0.255	0.191	0.312	4	005	○
GH4		5.5	5.53	TSU04K4NEBA	1.5P	3.15	0.591	1.181	1.713	0.255	0.191	0.312	4	005	○	
EG (STI)	5/16-24UNF	GH3	6.9	6.97	TSU05M3NEB5	5P	3.543	0.748	1.378	1.831	0.318	0.238	0.375	4	006	○
		GH3	6.9	6.97	TSU05M3NEBA	1.5P	3.543	0.748	1.378	1.831	0.318	0.238	0.375	4	006	○
GH4		6.9	6.97	TSU05M4NEB5	5P	3.543	0.748	1.378	1.831	0.318	0.238	0.375	4	006	○	
GH4		6.9	6.97	TSU05M4NEBA	1.5P	3.543	0.748	1.378	1.831	0.318	0.238	0.375	4	006	○	
SPECIAL THREADS, GAUGES	3/8-24UNF	GH3	8.5	8.57	TSU06M3NEB5	5P	3.937	0.906	1.535	2.028	0.381	0.286	0.437	4	006	○
		GH3	8.5	8.57	TSU06M3NEBA	1.5P	3.937	0.906	1.535	2.028	0.381	0.286	0.437	4	006	○
GH4		8.5	8.57	TSU06M4NEB5	5P	3.937	0.906	1.535	2.028	0.381	0.286	0.437	4	006	○	
GH4		8.5	8.57	TSU06M4NEBA	1.5P	3.937	0.906	1.535	2.028	0.381	0.286	0.437	4	006	○	
THREAD MILLS	7/16-20UNF	GH3	9.9	9.96	TSU07N3NEB5	5P	3.937	0.906	-	2.008	0.323	0.242	0.406	4	007	○
		GH3	9.9	9.96	TSU07N3NEBA	1.5P	3.937	0.906	-	2.008	0.323	0.242	0.406	4	007	○
GH4		9.9	9.96	TSU07N4NEB5	5P	3.937	0.906	-	2.008	0.323	0.242	0.406	4	007	○	
GH4		9.9	9.96	TSU07N4NEBA	1.5P	3.937	0.906	-	2.008	0.323	0.242	0.406	4	007	○	
DIES	1/2-20UNF	GH3	11.5	11.54	TSU08N3NEB5	5P	4.331	1.024	-	2.205	0.367	0.275	0.437	4	007	○
		GH3	11.5	11.54	TSU08N3NEBA	1.5P	4.331	1.024	-	2.205	0.367	0.275	0.437	4	007	○
GH4		11.5	11.54	TSU08N4NEB5	5P	4.331	1.024	-	2.205	0.367	0.275	0.437	4	007	○	
GH4		11.5	11.54	TSU08N4NEBA	1.5P	4.331	1.024	-	2.205	0.367	0.275	0.437	4	007	○	
CENTER DRILLS		GH5	11.5	11.54	TSU08N5NEB5	5P	4.331	1.024	-	2.205	0.367	0.275	0.437	4	007	○
		GH5	11.5	11.54	TSU08N5NEBA	1.5P	4.331	1.024	-	2.205	0.367	0.275	0.437	4	007	○

Technical
info

UNF	TCTR (tolerance)	 Hole Ø (mm)	Hole Ø (mm)	Code	THCHT (chamfer)	LF (inch)	THL (inch)	LU (inch)	LS (inch)	DCON (inch)	K (inch)	LK (inch)	NOF	Type	Stock
ANSI															
9/16-18UNF	GH3	12.9	13	TSU0903NEB5	5P	4.331	1.024	-	2.205	0.429	0.322	0.5	4	007	○
	GH3	12.9	13	TSU0903NEBA	1.5P	4.331	1.024	-	2.205	0.429	0.322	0.5	4	007	○
	GH4	12.9	13	TSU0904NEB5	5P	4.331	1.024	-	2.205	0.429	0.322	0.5	4	007	○
	GH4	12.9	13	TSU0904NEBA	1.5P	4.331	1.024	-	2.205	0.429	0.322	0.5	4	007	○
	GH5	12.9	13	TSU0905NEB5	5P	4.331	1.024	-	2.205	0.429	0.322	0.5	4	007	○
	GH5	12.9	13	TSU0905NEBA	1.5P	4.331	1.024	-	2.205	0.429	0.322	0.5	4	007	○
5/8-18UNF	GH3	14.5	14.6	TSU1003NEB5	5P	4.331	1.024	-	2.205	0.48	0.36	0.562	4	007	○
	GH3	14.5	14.6	TSU1003NEBA	1.5P	4.331	1.024	-	2.205	0.48	0.36	0.562	4	007	○
	GH4	14.5	14.6	TSU1004NEB5	5P	4.331	1.024	-	2.205	0.48	0.36	0.562	4	007	○
	GH4	14.5	14.6	TSU1004NEBA	1.5P	4.331	1.024	-	2.205	0.48	0.36	0.562	4	007	○
	GH5	14.5	14.6	TSU1005NEB5	5P	4.331	1.024	-	2.205	0.48	0.36	0.562	4	007	○
	GH5	14.5	14.6	TSU1005NEBA	1.5P	4.331	1.024	-	2.205	0.48	0.36	0.562	4	007	○
3/4-16UNF	GH3	17.5	17.59	TSU12P3NEB5	5P	4.921	1.299	-	2.52	0.59	0.442	0.687	4	007	○
	GH3	17.5	17.59	TSU12P3NEBA	1.5P	4.921	1.299	-	2.52	0.59	0.442	0.687	4	007	○
	GH4	17.5	17.59	TSU12P4NEB5	5P	4.921	1.299	-	2.52	0.59	0.442	0.687	4	007	○
	GH4	17.5	17.59	TSU12P4NEBA	1.5P	4.921	1.299	-	2.52	0.59	0.442	0.687	4	007	○
	GH5	17.5	17.59	TSU12P5NEB5	5P	4.921	1.299	-	2.52	0.59	0.442	0.687	4	007	○
	GH5	17.5	17.59	TSU12P5NEBA	1.5P	4.921	1.299	-	2.52	0.59	0.442	0.687	4	007	○
7/8-14UNF	GH4	20.5	20.57	TSU14Q4NEB5	5P	5.512	1.299	-	2.795	0.697	0.523	0.75	4	007	○
	GH4	20.5	20.57	TSU14Q4NEBA	1.5P	5.512	1.299	-	2.795	0.697	0.523	0.75	4	007	○
	GH6	20.5	20.57	TSU14Q6NEB5	5P	5.512	1.299	-	2.795	0.697	0.523	0.75	4	007	○
	GH6	20.5	20.57	TSU14Q6NEBA	1.5P	5.512	1.299	-	2.795	0.697	0.523	0.75	4	007	○
1-12UNF	GH4	23.3	23.46	TSU16S4NEB5	5P	6.299	1.457	-	3.228	0.8	0.6	0.812	4	007	○
	GH4	23.3	23.46	TSU16S4NEBA	1.5P	6.299	1.457	-	3.228	0.8	0.6	0.812	4	007	○
	GH5	23.3	23.46	TSU16S5NEB5	5P	6.299	1.457	-	3.228	0.8	0.6	0.812	4	007	○
	GH5	23.3	23.46	TSU16S5NEBA	1.5P	6.299	1.457	-	3.228	0.8	0.6	0.812	4	007	○
	GH6	23.3	23.46	TSU16S6NEB5	5P	6.299	1.457	-	3.228	0.8	0.6	0.812	4	007	○
	GH6	23.3	23.46	TSU16S6NEBA	1.5P	6.299	1.457	-	3.228	0.8	0.6	0.812	4	007	○
1 1/8-12UNF	GH5	26.5	26.63	TSU18S5NEB5	5P	7.087	1.732	-	3.622	0.896	0.672	0.875	4	007	○
	GH5	26.5	26.63	TSU18S5NEBA	1.5P	7.087	1.732	-	3.622	0.896	0.672	0.875	4	007	○
	GH6	26.5	26.63	TSU18S6NEB5	5P	7.087	1.732	-	3.622	0.896	0.672	0.875	4	007	○
	GH6	26.5	26.63	TSU18S6NEBA	1.5P	7.087	1.732	-	3.622	0.896	0.672	0.875	4	007	○
1 1/4-12UNF	GH5	29.6	29.81	TSU20S5NEB5	5P	7.087	1.929	-	3.622	1.021	0.766	1	6	007	○
	GH5	29.6	29.81	TSU20S5NEBA	1.5P	7.087	1.929	-	3.622	1.021	0.766	1	6	007	○
	GH6	29.6	29.81	TSU20S6NEB5	5P	7.087	1.929	-	3.622	1.021	0.766	1	6	007	○
	GH6	29.6	29.81	TSU20S6NEBA	1.5P	7.087	1.929	-	3.622	1.021	0.766	1	6	007	○
1 3/8-12UNF	GH5	32.8	32.98	TSU22S5NEB5	5P	7.874	2.165	-	4.016	1.108	0.831	1.062	6	007	○
	GH5	32.8	32.98	TSU22S5NEBA	1.5P	7.874	2.165	-	4.016	1.108	0.831	1.062	6	007	○
	GH6	32.8	32.98	TSU22S6NEB5	5P	7.874	2.165	-	4.016	1.108	0.831	1.062	6	007	○
	GH6	32.8	32.98	TSU22S6NEBA	1.5P	7.874	2.165	-	4.016	1.108	0.831	1.062	6	007	○
1 1/2-12UNF	GH5	36	36.16	TSU24S5NEB5	5P	7.874	2.323	-	4.016	1.233	0.925	1.125	6	007	○
	GH5	36	36.16	TSU24S5NEBA	1.5P	7.874	2.323	-	4.016	1.233	0.925	1.125	6	007	○
	GH7	36	36.16	TSU24S7NEB5	5P	7.874	2.323	-	4.016	1.233	0.925	1.125	6	007	○
	GH7	36	36.16	TSU24S7NEBA	1.5P	7.874	2.323	-	4.016	1.233	0.925	1.125	6	007	○

The most suitable GH tap class to cut accurate 2B, 3B (UNJ) and 2B oversized internal threads tolerance, depends on application conditions and work-piece materials. Yamawa GH class system offers a wide range of alternative tap classes allowing each customer to select the most suitable one according to application requirement. Check page 673 of Technical info for full details.

Intro

SP

SL

PO

ST
ANSI

ROLL

CARBIDE

LONG

HAND TAPS

EG (STI)

SPECIAL THREADS, GAUGES

THREAD MILLS

DIES

CENTER DRILLS

Technical info

Intro

NPT

GP General Purpose Series

Straight Fluted Taps for American Taper Pipe Threads



SP

SL



FEATURES

General purpose for blind and through hole application.
For steel application at low cutting speed, also suitable for cast iron and non-ferrous materials.

PO

Recommended Tapping Speeds Depending On Materials

ISO	Vc (m/min)	★	ISO	Vc (m/min)	☆	ISO	Vc (m/min)	☆
P1	≤5	★	K1	≤5	☆	N2	≤5	☆
P2	≤5	★	K2	≤5	☆	N4	≤5	☆
P3	≤5	☆						
P4	≤5	☆						

★ 1st choice ☆ suitable

ST

ANSI

ROLL

CARBIDE

LONG

HAND TAPS

EG (STI)

SPECIAL THREADS, GAUGES

THREAD MILLS

DIES

CENTER DRILLS

Technical info

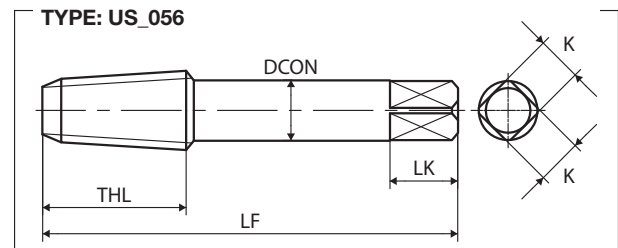
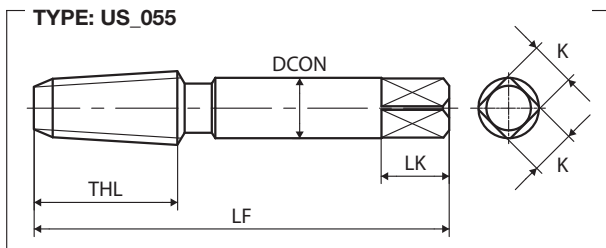

NPT	TCTR (tolerance)	Hole Ø (mm)	Hole Ø (mm)	Code	THCHT (chamfer)	Basic major Ø (mm)	LF (inch)	THL (inch)	LS (inch)	DCON (inch)	K (inch)	LK (inch)	NOF	Type	Stock
ANSI															
1/16-27	ANSI G	6	6.05	Y83100BR	3P	7.770	2.125	0.687	-	0.312	0.234	0.375	4	055	●
1/8-27	ANSI G	8.35	8.39	Y83101BR	3P	10.117	2.125	0.75	-	0.437	0.328	0.375	4	055	●
1/4-18	ANSI G	10.8	10.85	Y83103BR	3P	13.426	2.437	1.062	-	0.562	0.421	0.437	4	055	●
3/8-18	ANSI G	14.25	14.27	Y83104BR	3P	16.866	2.562	1.062	-	0.7	0.531	0.5	4	055	●
1/2-14	ANSI G	17.5	17.6	Y83105BR	3P	20.980	3.125	1.375	-	0.687	0.515	0.625	4	056	●
3/4-14	ANSI G	22.9	22.91	Y83106BR	3P	26.325	3.25	1.375	-	0.906	0.679	0.687	4	056	●
1 -11 1/2	ANSI G	28.75	28.78	Y83107BR	3P	32.934	3.75	1.75	-	1.125	0.843	0.812	5	056	●
1 1/4-11 1/2	ANSI G	37.4	37.5	Y83108BR	3P	41.689	4	1.75	-	1.312	0.984	0.937	5	056	○
1 1/2-11 1/2	ANSI G	43.5	43.57	Y83109BR	3P	47.760	4.25	1.75	-	1.5	1.125	1	6	056	○
2 -11 1/2	ANSI G	55.5	55.58	Y83110BR	3P	59.797	4.5	1.75	-	1.875	1.406	1.125	6	056	○

NPTF

GP General Purpose Series

Straight Fluted Taps for American Dryseal Taper Pipe Threads



FEATURES

General purpose for blind and through hole application. For steel application at low cutting speed.

Recommended Tapping Speeds Depending On Materials

ISO Vc (m/min)

P1	≤5	★
P2	≤5	★
P3	≤5	☆
P4	≤5	☆

★ 1st choice ☆ suitable

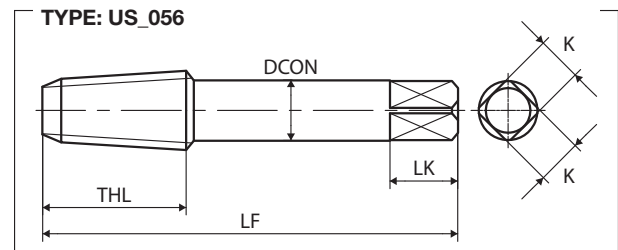
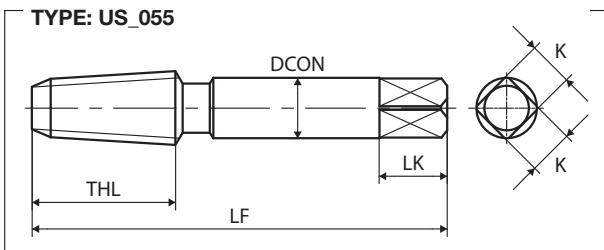

NPTF	TCTR (tolerance)	∅ (mm)	Hole ∅ (mm)	Code	THCHT (chamfer)	Basic major ∅ (mm)	LF (inch)	THL (inch)	LS (inch)	DCON (inch)	K (inch)	LK (inch)	NOF	Type	Stock
ANSI															
1/16-27	ANSI G	5.95	5.99	Y83125	3P	7.770	2.125	0.687	-	0.312	0.234	0.375	4	055	○
1/8-27	ANSI G	8.3	8.34	Y83126	3P	10.117	2.125	0.75	-	0.437	0.328	0.375	4	055	●
1/4-18	ANSI G	10.7	10.75	Y83128	3P	13.426	2.437	1.062	-	0.562	0.421	0.437	4	055	●
3/8-18	ANSI G	14.1	14.17	Y83129	3P	16.866	2.562	1.062	-	0.7	0.531	0.5	4	055	○
1/2-14	ANSI G	17.4	17.44	Y83130	3P	20.980	3.125	1.375	-	0.687	0.515	0.625	4	056	○
3/4-14	ANSI G	22.7	22.75	Y83131	3P	26.325	3.25	1.375	-	0.906	0.679	0.687	5	056	○
1 -11 1/2	ANSI G	28.5	28.6	Y83132	3P	32.934	3.75	1.75	-	1.125	0.843	0.812	5	056	○
1 1/4-11 1/2	ANSI G	37.3	37.33	Y83133	3P	41.689	4	1.75	-	1.312	0.984	0.937	5	056	○
1 1/2-11 1/2	ANSI G	43.3	43.4	Y83134	3P	47.760	4.25	1.75	-	1.5	1.125	1	6	056	○
2 -11 1/2	ANSI G	55.4	55.41	Y83135	3P	59.797	4.5	1.75	-	1.875	1.406	1.125	6	056	○

Intro

SP

SL

PO

ST

ANSI

ROLL

CARBIDE

LONG

HAND TAPS

EG (STI)

SPECIAL THREADS, GAUGES

THREAD MILLS

DIES

CENTER DRILLS

Technical info

Intro

NPS



SP

GP General Purpose Series

Straight Fluted Taps for American Parallel Pipe Threads

SL



FEATURES

General purpose for blind and through hole application.
For steel application at low cutting speed.

PO

Recommended Tapping Speeds Depending On Materials

ISO	Vc (m/min)
P1	5÷10 ☆
P2	5÷10 ★
P3	≤5 ☆
P4	≤5 ☆

ST

ANSI

★ 1st choice ☆ suitable

ROLL

CARBIDE

LONG

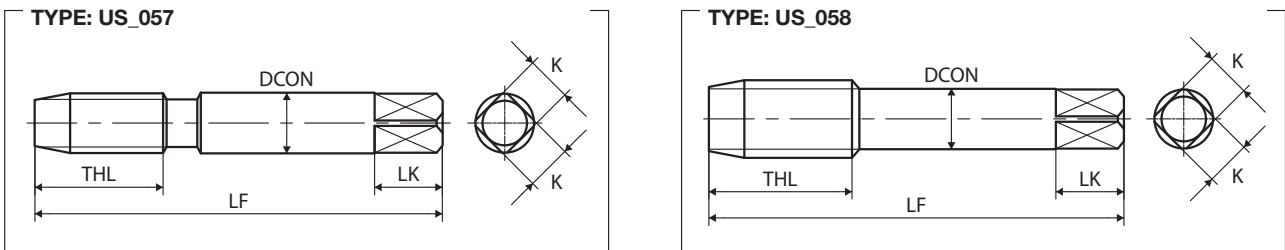

HAND TAPS

EG (STI)

SPECIAL THREADS, GAUGES

THREAD MILLS

DIES

CENTER DRILLS

Technical info

NPS	TCTR (tolerance)	Bored Hole Ø (mm)		Code	THCHT (chamfer)	Basic major Ø (mm)	LF (inch)	THL (inch)	LS (inch)	DCON (inch)	K (inch)	LK (inch)	NOF	Type	Stock
		NSPM	NSPC												
ANSI															
1/8-27	ANSI G	9.21	8.86	Y83301	4P	10.117	2.125	0.75	-	0.437	0.328	0.375	4	057	○
	ANSI G	9.21	8.86	Y83302	4P	10.117	2.125	0.75	-	0.312	0.234	0.375	4	058	○
1/4-18	ANSI G	12.13	11.53	Y83303	4P	13.426	2.437	1.062	-	0.562	0.421	0.437	4	057	○
3/8-18	ANSI G	15.49	14.98	Y83304	4P	16.866	2.562	1.062	-	0.7	0.531	0.5	4	057	○
1/2-14	ANSI G	19.2	18.52	Y83305	4P	20.980	3.125	1.375	-	0.687	0.515	0.625	4	058	○
3/4-14	ANSI G	24.6	23.88	Y83306	4P	26.325	3.25	1.375	-	0.906	0.679	0.687	5	058	○
1 -11 1/2	ANSI G	30.7	29.93	Y83307	4P	32.934	3.75	1.75	-	1.125	0.843	0.812	5	058	○

NPSF

GP General Purpose Series

Straight Fluted Taps for American Dryseal Parallel Pipe Threads



FEATURES

General purpose for blind and through hole application. For steel application at low cutting speed.

Recommended Tapping Speeds Depending On Materials

ISO Vc (m/min)

P1	5÷10	☆
P2	5÷10	★
P3	≤5	☆
P4	≤5	☆

★ 1st choice ☆ suitable

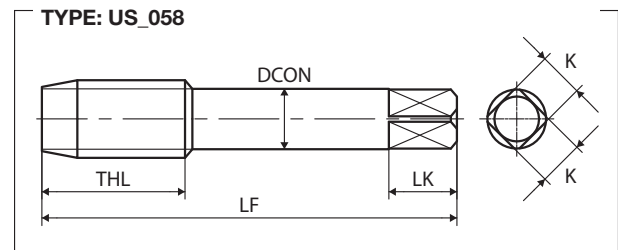
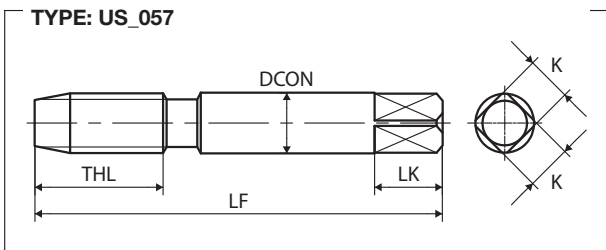

NPSF	TCTR (tolerance)	Hole Ø (mm)	Hole Ø (mm)	Code	THCHT (chamfer)	Basic major Ø (mm)	LF (inch)	THL (inch)	LS (inch)	DCON (inch)	K (inch)	LK (inch)	NOF	Type	Stock
ANSI															
1/8-27	ANSI G	8.7	8.72	Y83326	4P	10.117	2.125	0.75	-	0.437	0.328	0.375	4	057	○
	ANSI G	8.7	8.72	Y83327	4P	10.117	2.125	0.75	-	0.312	0.234	0.375	4	058	○
1/4-18	ANSI G	11.3	11.33	Y83328	4P	13.426	2.437	1.062	-	0.562	0.421	0.437	4	057	○
3/8-18	ANSI G	14.75	14.77	Y83329	4P	16.866	2.562	1.062	-	0.7	0.531	0.5	4	057	○
1/2-14	ANSI G	18.2	18.25	Y83330	4P	20.980	3.125	1.375	-	0.687	0.515	0.625	4	058	○
3/4-14	ANSI G	23.5	23.5	Y83331	4P	26.325	3.25	1.375	-	0.906	0.679	0.687	5	058	○
1 -11 1/2	ANSI G	29.5	29.6	Y83332	4P	32.934	3.75	1.75	-	1.125	0.843	0.812	5	058	○

Intro

SP

SL

PO

ST

ANSI

ROLL

CARBIDE

LONG

HAND TAPS

EG (STI)

SPECIAL THREADS, GAUGES

THREAD MILLS

DIES

CENTER DRILLS

Technical info

Intro

ZELX MOLD

MS Material Specific Series

Straight Fluted Taps for Hard Materials (<45HRC)



SP

SL



PO

Recommended Tapping Speeds Depending On Materials

ISO	Vc (m/min)		ISO	Vc (m/min)	
P5	≤5	★	K2	≤5	☆
P6	≤5	★	K3	≤5	☆

★ 1st choice ☆ suitable

ST

ANSI

ROLL

CARBIDE

LONG

HAND TAPS

EG (STI)

SPECIAL THREADS, GAUGES

THREAD MILLS

DIES

CENTER DRILLS

Technical info

FEATURES

Material specific for blind and through hole application. For high tensile strength steel <45HRC. Specific geometry and HSSCo allow stable and long life.

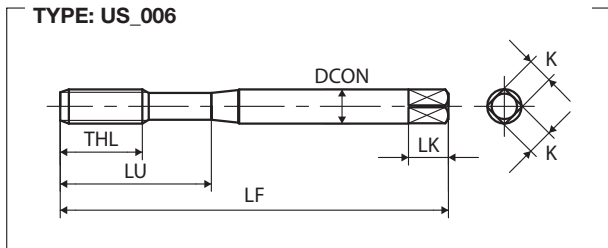
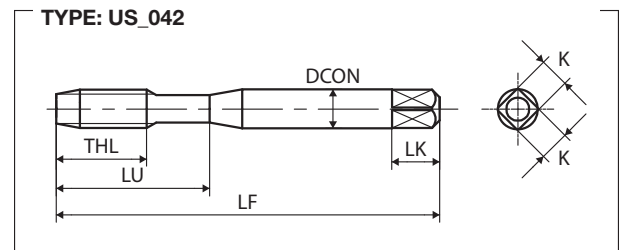
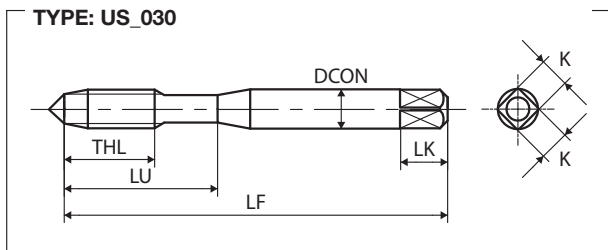

UNC	TCTR (tolerance)	 Hole Ø (mm)	Hole Ø (mm)	Code	THCHT (chamfer)	LF (inch)	THL (inch)	LU (inch)	LS (inch)	DCON (inch)	K (inch)	LK (inch)	NOF	Type	Stock
ANSI															
No.4-40UNC	GH2	2.3	2.33	Y89599	5P	1.875	0.335	0.562	-	0.141	0.11	0.187	3	030	○
No.5-40UNC	GH2	2.6	2.64	Y89601	5P	1.937	0.374	0.625	-	0.141	0.11	0.187	3	030	○
No.6-32UNC	GH3	2.8	2.83	Y89602	5P	2	0.413	0.687	-	0.141	0.11	0.187	3	030	○
No.8-32UNC	GH3	3.4	3.47	Y89604	5P	2.125	0.453	0.75	-	0.168	0.131	0.25	3	030	○
No.10-24UNC	GH3	3.89	3.9	Y89606	5P	2.375	0.531	0.875	-	0.194	0.152	0.25	3	030	○
1/4-20UNC	GH3	5.1	5.19	Y89613	5P	2.5	0.591	1	-	0.255	0.191	0.312	3	042	○
5/16-18UNC	GH3	6.6	6.65	Y89615	5P	2.718	0.669	1.125	-	0.318	0.238	0.375	4	042	○
3/8-16UNC	GH3	8	8.07	Y89617	5P	2.937	0.748	1.25	-	0.381	0.286	0.437	4	042	○
7/16-14UNC	GH3	9.4	9.45	Y89619	5P	3.156	0.866	-	-	0.323	0.242	0.406	4	006	○
1/2-13UNC	GH3	10.9	10.91	Y89621	5P	3.375	0.984	-	-	0.367	0.275	0.437	4	006	○
5/8-11UNC	GH3	13.6	13.75	Y89625	5P	3.812	1.083	-	-	0.48	0.36	0.562	4	006	○
3/4-10UNC	GH3	16.6	16.7	Y89627	5P	4.25	1.201	-	-	0.59	0.422	0.687	4	006	○
ANSI															
ANSI															
No.10-32UNF	GH3	4.1	4.12	Y89607	5P	2.375	0.531	0.875	-	0.194	0.152	0.25	3	030	○
1/4-28UNF	GH3	5.5	5.53	Y89614	5P	2.5	0.591	1	-	0.255	0.191	0.312	3	042	○
5/16-24UNF	GH3	6.9	6.97	Y89616	5P	2.718	0.669	1.125	-	0.318	0.238	0.375	4	042	○
3/8-24UNF	GH3	8.5	8.57	Y89618	5P	2.937	0.748	1.25	-	0.381	0.286	0.437	4	042	○
7/16-20UNF	GH3	9.9	9.96	Y89620	5P	3.156	0.866	-	-	0.323	0.242	0.406	4	006	○
1/2-20UNF	GH3	11.5	11.54	Y89622	5P	3.375	0.984	-	-	0.367	0.275	0.437	4	006	○
5/8-18UNF	GH3	14.5	14.6	Y89626	5P	3.812	1.083	-	-	0.48	0.36	0.562	4	006	○
3/4-16UNF	GH3	17.5	17.59	Y89628	5P	4.25	1.201	-	-	0.59	0.422	0.687	4	006	○

Intro

SP

SL

PO

ST

ANSI

ROLL

CARBIDE

LONG

HAND TAPS

EG (STI)

SPECIAL THREADS, GAUGES

THREAD MILLS

DIES

CENTER DRILLS

Technical info

The most suitable GH tap class to cut accurate 2B, 3B (UNJ) and 2B oversized internal threads tolerance, depends on application conditions and work-piece materials. Yamawa GH class system offers a wide range of alternative tap classes allowing each customer to select the most suitable one according to application requirement. Check page 673 of Technical info for full details.

Intro

ZELX MOLD NPT



MS Material Specific Series

SP Straight Fluted Taps for American Taper Pipe Threads, for Hard Materials (<45HRC)

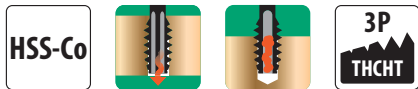

FEATURES

Material specific for blind and through hole application. For high tensile strength steel <45HRC. Specific geometry and HSSCo allow stable and long life.

SL

PO Recommended Tapping Speeds Depending On Materials

ISO	Vc (m/min)	★	ISO	Vc (m/min)	☆
P5	≤5	★	K2	≤5	☆
P6	≤5	★	K3	≤5	☆

★ 1st choice ☆ suitable

ST

ANSI

ROLL

CARBIDE

LONG

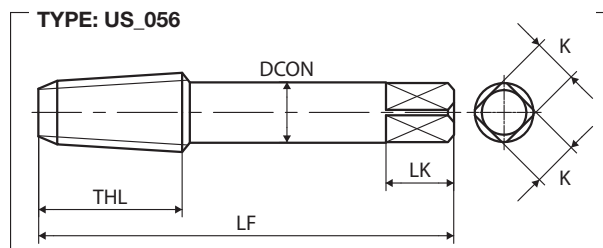
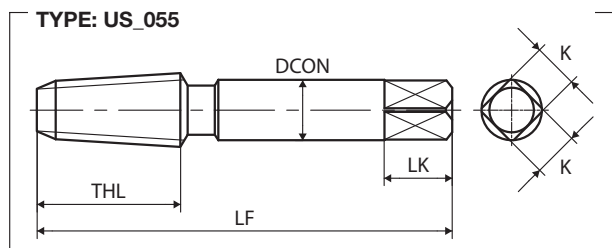

HAND TAPS

NPT	TCTR (tolerance)	Hole Ø (mm)	Hole Ø (mm)	Code	THCHT (chamfer)	Basic major Ø (mm)	LF (inch)	THL (inch)	LS (inch)	DCON (inch)	K (inch)	LK (inch)	NOF	Type	Stock
ANSI															
1/8-27	ANSI G	8.35	8.39	Y89641	3P	10.117	2.125	0.75	-	0.437	0.328	0.375	4	055	○
1/4-18	ANSI G	10.8	10.85	Y89643	3P	13.426	2.437	1.062	-	0.562	0.421	0.437	4	055	○
3/8-18	ANSI G	14.25	14.27	Y89644	3P	16.866	2.562	1.062	-	0.7	0.531	0.5	4	055	○
1/2-14	ANSI G	17.5	17.6	Y89645	3P	20.980	3.125	1.375	-	0.687	0.515	0.625	4	056	○
3/4-14	ANSI G	22.9	22.91	Y89646	3P	26.325	3.25	1.375	-	0.906	0.679	0.687	5	056	○

EG (STI)

SPECIAL THREADS, GAUGES

THREAD MILLS

DIES

CENTER DRILLS

Technical info

FORMING TAPS

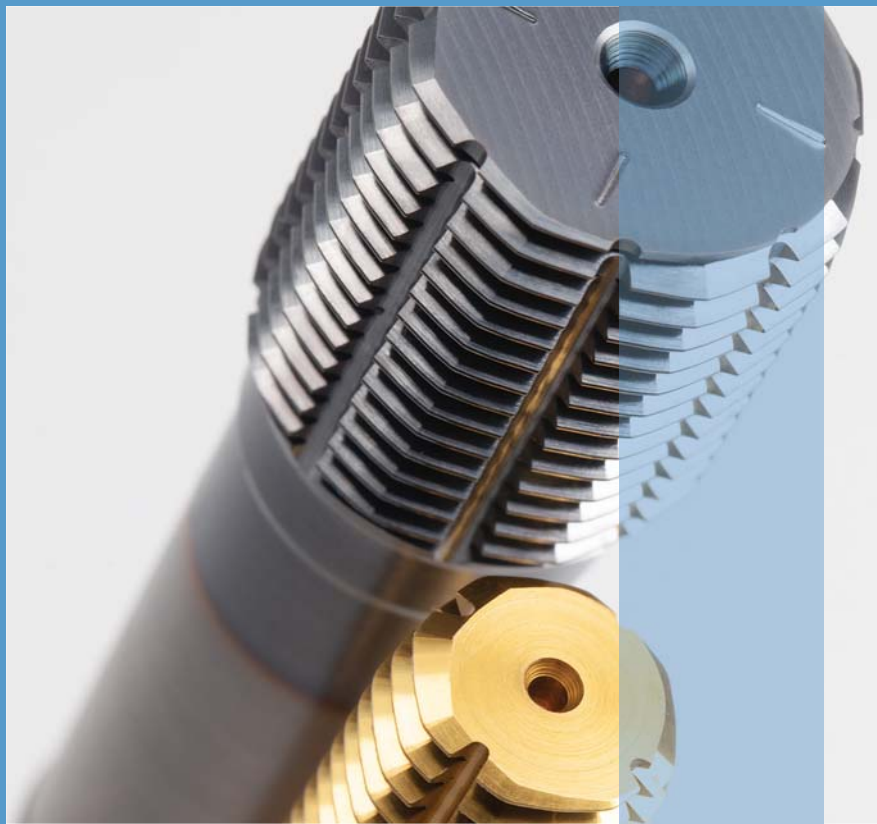

ROLL - DIN **350**
ROLL - JIS **362**
ROLL - ANSI **388**

Selection Chart

Intro

SP

SL

PO

ST

ROLL

CARBIDE

LONG

HAND TAPS

EG (STI)

SPECIAL THREADS, GAUGES

THREAD MILLS





DIES

CENTER DRILLS

Technical info

	Z-PRO		GP General Purpose						MP Multi Purpose						
	MHRZ		R-D	R-D V	R+V	N+RZ/N-RZ	N+RS/N-RS	HP+RZ/HP-RZ		HP+RZ/HP-RZ ISO3X(6GX)					
	HSS-Co	COATING	HSS-E	HSS-E	COATING	HSS-E	COATING	HSS-E	OX	HSS-E	NI	HSS-P	COATING	HSS-P	COATING
	DIN	DIN	DIN	JIS	DIN	JIS	DIN	JIS	DIN	JIS	ANSI	DIN			
M	351	353	355	363	356	367	357	372	359	379		359			
MF	351					369		375	359	380					
UNC/UNF						370		376		380	389				
UNS, 8, 12, 20, 32UN															
UNEF															
G (BSP)		353	355												
Rp (BSPP)															
Rc (BSPT)															
NPT															
NPTF															
NPSC, NPSM, NPSF															
BSW															
EG(STI), M, MF, UNC/UNF															
Pg															
Tr															
S miniature															
Special threads															
	Vc (m/min)														
P1		★ 5÷15	★ 10÷20	★ 10÷20	★ 5÷15				★ 15÷30	★ 15÷30					
P2	★ 10÷30	☆ 5÷15	★ 10÷20	★ 10÷20	★ 5÷10				★ 15÷30	★ 15÷30					
P3	★ 10÷30								★ 15÷25	★ 15÷25					
P4	★ 10÷30								★ 15÷25	★ 15÷25					
P5															
P6															
P7			☆ 8÷12	☆ 5÷12					★ 10÷25	★ 10÷25					
P8															
M1			☆ 8÷12	☆ 5÷12					★ 10÷25	★ 10÷25					
M2									★ 10÷25	★ 10÷25					
M3															
K1															
K2															
K3															
K4															
N1	☆ 10÷30	☆ 10÷15	☆ 10÷20	☆ 10÷20				★ 5÷15	☆ 10÷45	☆ 10÷45					
N2	☆ 10÷30	☆ 10÷15	☆ 10÷20	☆ 10÷20				★ 5÷15	☆ 10÷45	☆ 10÷45					
N3			☆ 10÷20	☆ 10÷20				★ 5÷15							
N4															
N5															
S1 (<25 HRC)															
S2 (<35 HRC)															
S3 (35 ÷ 45 HRC)															
S5															
H (45 ÷ 55 HRC)															
H (55 ÷ 63 HRC)															

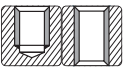
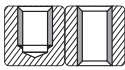
★ 1st choice ☆ suitable

MP Multi Purpose					
SURZ		SC-TL-RZ		OL+RZ/OL-RZ	
HSS-P	COATING	HSS-P	COATING	HSS-P	COATING
					
					
					
JIS	JIS	DIN	JIS		
383	385	361	386	M	
383	385			MF	
383	385			UNC/UNF	
				UNS, 8, 12, 20, 32UN	
				UNEF	
				G (BSP)	
				Rp (BSPP)	
				Rc (BSPT)	
				NPT	
				NPTF	
				NPSC, NPSM, NPSF	
				BSW	
				EG(STI), M, MF, UNC/UNF	
				Pg	
				Tr	
				S miniature	
				Special threads	
Vc (m/min)					
★ 15÷30	★ 15÷30	★ 15÷30		P1	
★ 15÷30	★ 15÷30	★ 15÷30		P2	
★ 15÷25	★ 15÷25	★ 15÷25		P3	
★ 15÷25	★ 15÷25	★ 15÷25		P4	
				P5	
				P6	
★ 10÷25	★ 10÷25	★ 10÷25		P7	
				P8	
★ 10÷25	★ 10÷25	★ 10÷25		M1	
★ 10÷25	★ 10÷25	★ 10÷25		M2	
				M3	
				K1	
				K2	
				K3	
				K4	
	☆ 10÷45	☆ 10÷45		N1	
	☆ 10÷45	☆ 10÷45		N2	
				N3	
				N4	
				N5	
				S1 (<25 HRC)	
				S2 (<35 HRC)	
				S3 (35 ÷ 45 HRC)	
				S5	
				H (45 ÷ 55 HRC)	
				H (55 ÷ 63 HRC)	

Intro

SP

SL

PO

ST

ROLL

CARBIDE

LONG

HAND
TAPS

EG (STI)

SPECIAL
THREADS,
GAUGESTHREAD
MILLS

DIES

CENTER
DRILLSTechnical
info

Intro

MHRZ



SP

Z-PRO Series

Roll Taps for Carbon Steel of Medium Hardness, Coated

SL



PO

Recommended Tapping Speeds Depending On Materials

ISO	Vc (m/min)	ISO	Vc (m/min)
P2	10÷30 ★	N1	10÷30 ☆
P3	10÷30 ★	N2	10÷30 ☆
P4	10÷30 ★		

★ 1st choice ☆ suitable

FEATURES

Z-PRO Series forming tap with special design for low tapping torque.

HSSCo and suitable coating for long life on Medium Hard steel (<35HRC) application.

2P chamfer for blind hole application, 4P chamfer for through hole application.



WATCH THE VIDEO

ROLL

DIN

CARBIDE

LONG

HAND TAPS

EG (STI)

Product Features

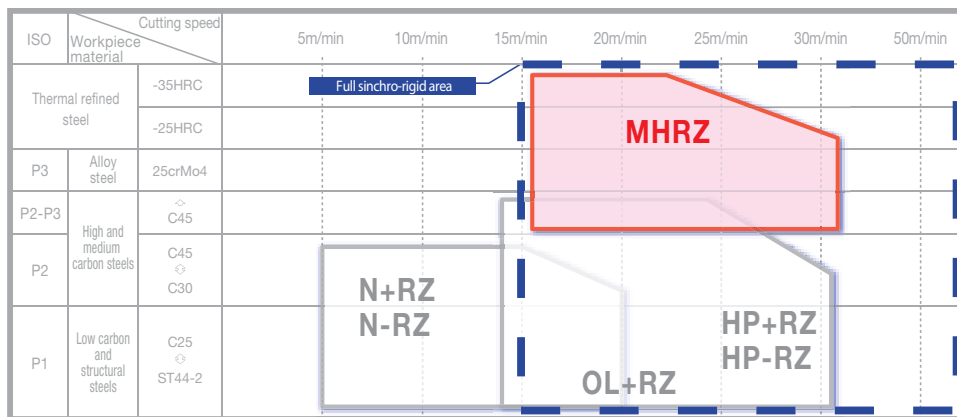

SPECIAL THREADS, GAUGES

THREAD MILLS

M12x1.25

Workpiece material	42CrMo4 - 1.7225(35HRC)
Cutting speed	20 m/min
Bored hole	ø11.3 mm
Thread length	18 mm (through hole)
Machine	Machining center (synchro)
Lubricant	Water soluble oil
No. of threads	800 threads (still running)

MHRZ

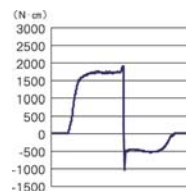

Competitor

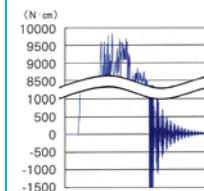

DIES

CENTER DRILLS

Technical info

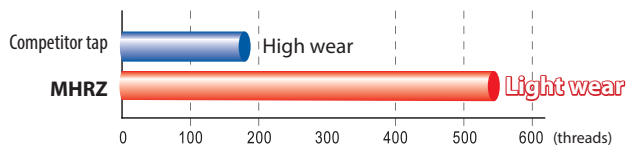

MHRZ finishing



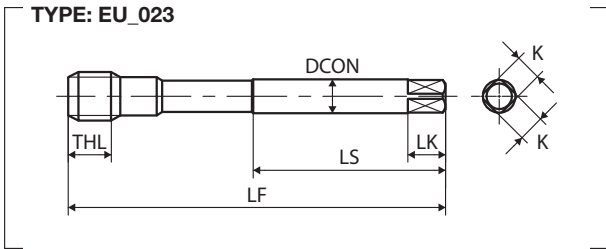
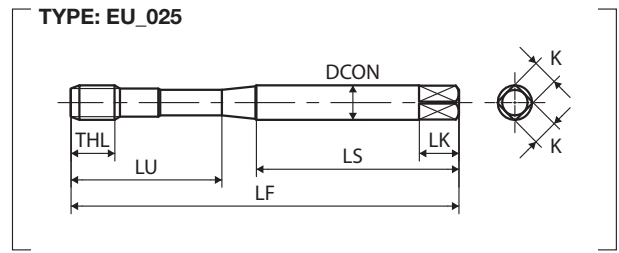
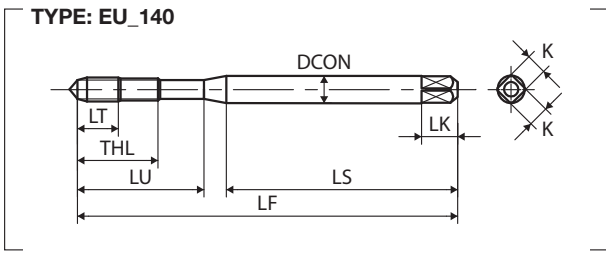

M	TCTR (tolerance)	Bored Hole Ø (mm)		Code	THCHT (chamfer)	LF (mm)	THL (mm)	LU (mm)	LS (mm)	DCON (mm)	K (mm)	LK (mm)	NOF (Lobes)	Type	Stock
		Max	Min												
DIN 371															
M6X1	ISO2X(6HX)	5.61	5.5	RD6.0MBOCTP	4P	80	11	30	45	6	4.9	8	5(5)	140	●
	ISO2X(6HX)	5.61	5.5	RD6.0MBOCTB	2P	80	11	30	45	6	4.9	8	5(5)	025	●
M8X1.25	ISO2X(6HX)	7.52	7.38	RD8.0NBOCTP	4P	90	12	35	47	8	6.2	9	6(6)	025	●
	ISO2X(6HX)	7.52	7.38	RD8.0NBOCTB	2P	90	12	35	47	8	6.2	9	6(6)	025	●
M10X1.5	ISO2X(6HX)	9.41	9.26	RD0100BOCTP	4P	100	13	39	52	10	8	11	8(8)	025	●
	ISO2X(6HX)	9.41	9.26	RD0100BOCTB	2P	100	13	39	52	10	8	11	8(8)	025	●
DIN 376															
M12X1.75	ISO2X(6HX)	11.3	11.13	RG012PBOCTP	4P	110	15	-	56	9	7	10	8(8)	023	●
	ISO2X(6HX)	11.3	11.13	RG012PBOCTB	2P	110	15	-	56	9	7	10	8(8)	023	●
DIN 374															
M10X1.25	ISO2X(6HX)	9.51	9.38	RM010NBOCTP	4P	100	13	-	51	7	5.5	8	8(8)	023	●
	ISO2X(6HX)	9.51	9.38	RM010NBOCTB	2P	100	13	-	51	7	5.5	8	8(8)	023	●
M12X1.5	ISO2X(6HX)	11.39	11.24	RM0120BOCTP	4P	100	15	-	51	9	7	10	8(8)	023	●
	ISO2X(6HX)	11.39	11.24	RM0120BOCTB	2P	100	15	-	51	9	7	10	8(8)	023	●
M12X1.25	ISO2X(6HX)	11.51	11.38	RM012NBOCTP	4P	100	15	-	51	9	7	10	8(8)	023	●
	ISO2X(6HX)	11.51	11.38	RM012NBOCTB	2P	100	15	-	51	9	7	10	8(8)	023	●
M14X1.5	ISO2X(6HX)	13.39	13.24	RM0140BOCTP	4P	100	14	-	51	11	9	12	8(8)	023	●
	ISO2X(6HX)	13.39	13.24	RM0140BOCTB	2P	100	14	-	51	11	9	12	8(8)	023	●
M16X1.5	ISO2X(6HX)	15.38	15.23	RM0160BOCTP	4P	100	18	-	51	12	9	12	8(8)	023	○
	ISO2X(6HX)	15.38	15.23	RM0160BOCTB	2P	100	18	-	51	12	9	12	8(8)	023	●
M18X1.5	ISO2X(6HX)	17.38	17.23	RM0180BOCTP	4P	110	20	-	56	14	11	14	8(8)	023	○
	ISO2X(6HX)	17.38	17.23	RM0180BOCTB	2P	110	20	-	56	14	11	14	8(8)	023	●
M20X1.5	ISO2X(6HX)	19.37	19.22	RM0200BOCTP	4P	125	20	-	64	16	12	15	8(8)	023	○
	ISO2X(6HX)	19.37	19.22	RM0200BOCTB	2P	125	20	-	64	16	12	15	8(8)	023	●

Intro
SP
SL
PO
ST

ROLL
DIN
CARBIDE
LONG
HAND TAPS
EG (STI)
SPECIAL THREADS, GAUGES
THREAD MILLS
DIES
CENTER DRILLS

Technical info

Intro

R-D

GP General Purpose Series

Thread Forming Taps for Low Hardness Materials



SP

SL

PO

ST



Recommended Tapping Speeds Depending On Materials

ISO	Vc (m/min)		ISO	Vc (m/min)	
P1	5÷15	★	N1	10÷15	☆
P2	5÷15	☆	N2	10÷15	☆

★ 1st choice ☆ suitable

FEATURES

General purpose forming taps for blind and through hole application.

For steel and non-ferrous materials.

ROLL

DIN

CARBIDE

LONG

HAND TAPS

EG (STI)

SPECIAL THREADS, GAUGES

THREAD MILLS

DIES

CENTER DRILLS

Technical info

TYPE: SP_025

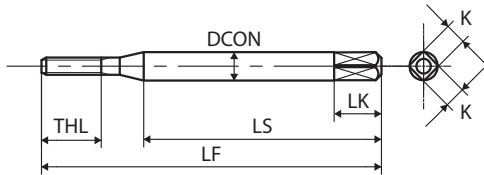

TYPE: EU_136

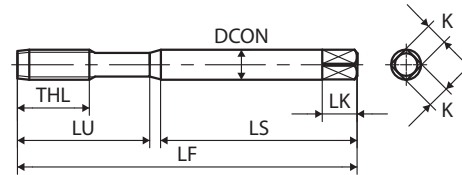

TYPE: EU_116

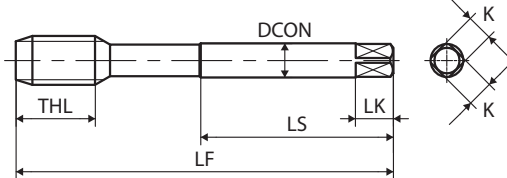

M	TCTR (tolerance)	Bored Hole Ø (mm)		Code	THCHT (chamfer)	LF (mm)	THL (mm)	LU (mm)	LS (mm)	DCON (mm)	K (mm)	LK (mm)	NOF (Lobes)	Type	Stock
		Max	Min												
DIN 371															
M2X0.4	ISO2X(6HX)	1.86	1.8	RD2.0EBNEBB	2P	45	8	-	32	2.8	2.1	5	0(4)	025	●
M2.5X0.45	ISO2X(6HX)	2.34	2.27	RD2.5FBNEBB	2P	50	8	15	33	2.8	2.1	5	0(4)	136	●
M3X0.5	ISO2X(6HX)	2.83	2.76	RD3.0GBNEBB	2P	56	9	18	34	3.5	2.7	6	4(4)	136	●
M3.5X0.6	ISO2X(6HX)	3.29	3.21	RD3.5HBNEBB	2P	56	11	20	32	4	3	6	4(4)	136	○
M4X0.7	ISO2X(6HX)	3.75	3.66	RD4.0IBNEBB	2P	63	13	21	38	4.5	3.4	6	4(4)	136	●
M5X0.8	ISO2X(6HX)	4.7	4.6	RD5.0KBNEBB	2P	70	14	25	39	6	4.9	8	4(4)	136	●
M6X1	ISO2X(6HX)	5.61	5.5	RD6.0MBNEBB	2P	80	15	30	45	6	4.9	8	4(4)	136	●
M8X1.25	ISO2X(6HX)	7.52	7.38	RD8.0NBNEBB	2P	90	19	35	47	8	6.2	9	3(6)	136	●
M10X1.5	ISO2X(6HX)	9.41	9.26	RD0100BNEBB	2P	100	23	39	52	10	8	11	4(8)	136	●
M	TCTR (tolerance)	Bored Hole Ø (mm)		Code	THCHT (chamfer)	LF (mm)	THL (mm)	LU (mm)	LS (mm)	DCON (mm)	K (mm)	LK (mm)	NOF (Lobes)	Type	Stock
		Max	Min												
DIN 376															
M12X1.75	ISO2X(6HX)	11.3	11.13	RG012PBNEBB	2P	110	26	-	56	9	7	10	4(8)	116	●
M14X2	ISO2X(6HX)	13.19	13	RG014QBNEBB	2P	110	26	-	56	11	9	12	4(8)	116	○
M16X2	ISO2X(6HX)	15.19	15	RG016QBNEBB	2P	110	26	-	56	12	9	12	4(8)	116	○
G(BSP)	TCTR (tolerance)	Bored Hole Ø (mm)		Code	THCHT (chamfer)	Basic major Ø (mm)	THL (mm)	LU (mm)	LS (mm)	DCON (mm)	K (mm)	LK (mm)	NOF (Lobes)	Type	Stock
		Max	Min												
DIN 5156															
1/8-28	-	9.36	9.22	RVG0026NEBB	2P	9.728	90	19	46	7	5.5	8	4(8)	116	●
1/4-19	-	12.64	12.42	RVG0047NEBB	2P	13.157	100	21	51	11	9	12	4(8)	116	●
3/8-19	-	16.14	15.92	RVG0067NEBB	2P	16.662	100	21	51	12	9	12	4(8)	116	●

Intro

SP

SL

PO

ST

ROLL

DIN

CARBIDE

LONG

HAND
TAPS

EG (STI)

SPECIAL
THREADS,
GAUGESTHREAD
MILLS

DIES

CENTER
DRILLSTechnical
info

Intro

R-D V

GP General Purpose Series

Thread Forming Taps for Low Hardness Materials, Coated



SP

SL

PO

ST



Recommended Tapping Speeds Depending On Materials

ISO	Vc (m/min)	ISO	Vc (m/min)	ISO	Vc (m/min)
P1	10÷20 ★	M1	8÷12 ☆	N1	10÷20 ☆
P2	10÷20 ★			N2	10÷20 ☆
P7	8÷12 ☆			N3	10÷20 ☆

★ 1st choice ☆ suitable

FEATURES

General purpose forming taps for blind and through hole application.

For steel and non-ferrous materials.

Suitable coating allows higher speed and longer life.

ROLL

DIN

CARBIDE

LONG

HAND TAPS

EG (STI)

SPECIAL THREADS, GAUGES

THREAD MILLS

DIES

CENTER DRILLS

Technical info

TYPE: SP_025

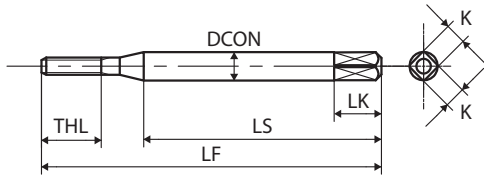

TYPE: EU_136

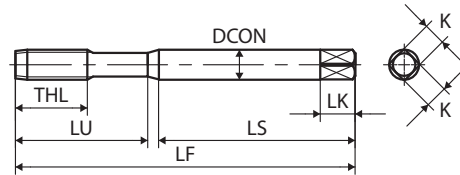

TYPE: EU_116

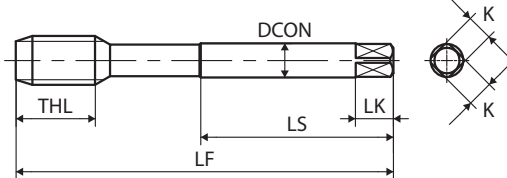

M	TCTR (tolerance)	Bored Hole Ø (mm)		Code	THCHT (chamfer)	LF (mm)	THL (mm)	LU (mm)	LS (mm)	DCON (mm)	K (mm)	LK (mm)	NOF (Lobes)	Type	Stock
		Max	Min												
DIN 371															
M2X0.4	ISO2X(6HX)	1.86	1.8	93532.0BTI	2P	45	8	-	32	2.8	2.1	5	0(4)	025	●
M2.5X0.45	ISO2X(6HX)	2.34	2.27	93532.5BTI	2P	50	8	15	33	2.8	2.1	5	0(4)	136	●
M3X0.5	ISO2X(6HX)	2.83	2.76	93533.0BTI	2P	56	9	18	34	3.5	2.7	6	4(4)	136	●
M3.5X0.6	ISO2X(6HX)	3.29	3.21	93533.5BTI	2P	56	11	20	32	4	3	6	4(4)	136	●
M4X0.7	ISO2X(6HX)	3.75	3.66	93534.0BTI	2P	63	13	21	38	4.5	3.4	6	4(4)	136	●
M5X0.8	ISO2X(6HX)	4.7	4.6	93535.0BTI	2P	70	14	25	39	6	4.9	8	4(4)	136	●
M6X1	ISO2X(6HX)	5.61	5.5	93536.0BTI	2P	80	15	30	45	6	4.9	8	4(4)	136	●
M8X1.25	ISO2X(6HX)	7.52	7.38	93538.0BTI	2P	90	19	35	47	8	6.2	9	3(6)	136	●
M10X1.5	ISO2X(6HX)	9.41	9.26	9353010BTI	2P	100	23	39	52	10	8	11	4(8)	136	●
DIN 376															
M12X1.75	ISO2X(6HX)	11.3	11.13	9353012BTI	2P	110	26	-	56	9	7	10	4(8)	116	●
M14X2	ISO2X(6HX)	13.19	13	9353014BTI	2P	110	26	-	56	11	9	12	4(8)	116	●
M16X2	ISO2X(6HX)	15.19	15	9353016BTI	2P	110	26	-	56	12	9	12	4(8)	116	●
DIN 5156															
G(BSP)	TCTR (tolerance)	Bored Hole Ø (mm)		Code	THCHT (chamfer)	Basic major Ø (mm)	THL (mm)	LU (mm)	LS (mm)	DCON (mm)	K (mm)	LK (mm)	NOF (Lobes)	Type	Stock
		Max	Min												
1/8-28	-	9.36	9.22	9953R02TI	2P	9.728	90	19	46	7	5.5	8	4(8)	116	●
1/4-19	-	12.64	12.42	9953R04TI	2P	13.157	100	21	51	11	9	12	4(8)	116	●
3/8-19	-	16.14	15.92	9953R06TI	2P	16.662	100	21	51	12	9	12	4(8)	116	●

Intro

SP

SL

PO

ST

ROLL

DIN

CARBIDE

LONG

HAND
TAPS

EG (STI)

SPECIAL
THREADS,
GAUGESTHREAD
MILLS

DIES

CENTER
DRILLSTechnical
info

Intro

N+RZ/N-RZ

GP General Purpose Series

Thread Forming Taps for Steel



SP

SL



PO

Recommended Tapping Speeds Depending On Materials

ISO Vc (m/min)

P1 5÷15 ★

P2 5÷10 ★

ST

★ 1st choice ☆ suitable

ROLL

DIN

CARBIDE

LONG

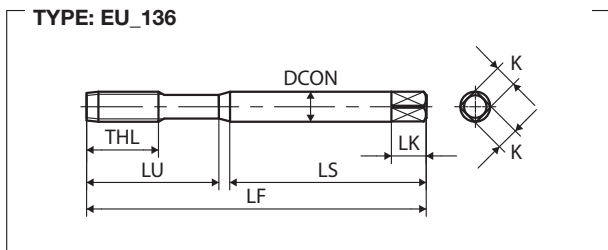

HAND TAPS

EG (STI)

SPECIAL THREADS, GAUGES

THREAD MILLS

DIES

CENTER DRILLS

Technical info

FEATURES

General purpose forming taps for blind and through hole application.

Suitable for soft structural steel and medium-low carbon steel application.

OX treatment reduces welding troubles.

M	TCTR (tolerance)	Bored Hole Ø (mm)		Code	THCHT (chamfer)	LF (mm)	THL (mm)	LU (mm)	LS (mm)	DCON (mm)	K (mm)	LK (mm)	NOF (Lobes)	Type	Stock
		Max	Min												
DIN 371															
M2.5X0.45	ISO2X(6HX)	2.34	2.27	RE2.5FBHEXB	2P	50	8	15	33	2.8	2.1	5	0(4)	136	○
M3X0.5	ISO2X(6HX)	2.83	2.76	RE3.0GBHEXB	2P	56	9	18	34	3.5	2.7	6	4(4)	136	●
M4X0.7	ISO2X(6HX)	3.75	3.66	RE4.0IBHEXB	2P	63	13	21	38	4.5	3.4	6	4(4)	136	●
M5X0.8	ISO2X(6HX)	4.7	4.6	RE5.0KBHEXB	2P	70	14	25	39	6	4.9	8	4(4)	136	●
M6X1	ISO2X(6HX)	5.61	5.5	RE6.0MBHEXB	2P	80	15	30	45	6	4.9	8	4(4)	136	●
M8X1.25	ISO2X(6HX)	7.52	7.38	RD8.0NBHEXB	2P	90	19	35	47	8	6.2	9	3(6)	136	●
M10X1.5	ISO2X(6HX)	9.41	9.26	RD0100BHEXB	2P	100	23	39	52	10	8	11	4(8)	136	●

N+RS/N-RS

GP General Purpose Series

Thread Forming Taps for Non-Ferrous Materials



Recommended Tapping Speeds Depending On Materials

ISO	Vc (m/min)
N1	5÷15 ★
N2	5÷15 ★
N3	5÷15 ★

★ 1st choice ☆ suitable



FEATURES

General purpose forming taps for blind and through hole application.

Suitable for non-ferrous materials.

NI treatment improves tool life.

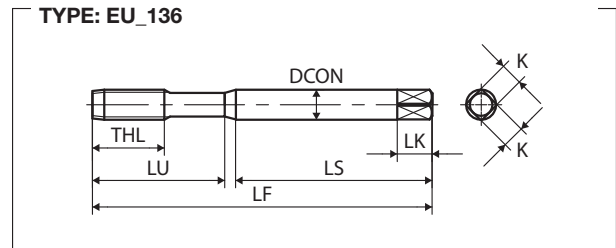
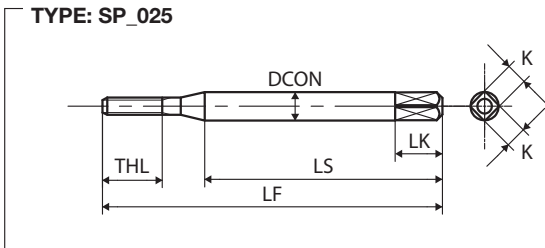

M	TCTR (tolerance)	Bored Hole Ø (mm)		Code	THCHT (chamfer)	LF (mm)	THL (mm)	LU (mm)	LS (mm)	DCON (mm)	K (mm)	LK (mm)	NOF (Lobes)	Type	Stock
		Max	Min												
DIN 371															
M2X0.4	IS02X(6HX)	1.86	1.8	RE2.0EBKENB	2P	45	8	-	32	2.8	2.1	5	0(4)	025	●
M2.5X0.45	IS02X(6HX)	2.34	2.27	RE2.5FBKENB	2P	50	8	15	33	2.8	2.1	5	0(4)	136	●
M3X0.5	IS02X(6HX)	2.83	2.76	RE3.0GBKENB	2P	56	9	18	34	3.5	2.7	6	1(4)	136	●
M4X0.7	IS02X(6HX)	3.75	3.66	RE4.0IBKENB	2P	63	13	21	38	4.5	3.4	6	1(4)	136	●
M5X0.8	IS02X(6HX)	4.7	4.6	RE5.0KBKENB	2P	70	14	25	39	6	4.9	8	1(4)	136	●
M6X1	IS02X(6HX)	5.61	5.5	RE6.0MBKENB	2P	80	15	30	45	6	4.9	8	1(4)	136	●
M8X1.25	IS02X(6HX)	7.52	7.38	RD8.0NBKENB	2P	90	19	35	47	8	6.2	9	1(6)	136	●
M10X1.5	IS02X(6HX)	9.41	9.26	RD0100BKENB	2P	100	23	39	52	10	8	11	1(6)	136	●

Intro

SP

SL

PO

ST

ROLL

DIN

CARBIDE

LONG

HAND
TAPS

EG (STI)

SPECIAL
THREADS,
GAUGES

THREAD
MILLS

DIES

CENTER
DRILLS

Technical
info

Intro **HP+RZ/HP-RZ**

MP Multi Purpose Series

High Performance Thread Forming Taps, Coated



FEATURES

Multi purpose forming taps for blind and through hole application on a wide range of materials.

Specific design, HSSP substrate and suitable coating for stable and long life even at medium-high speed.

Recommended Tapping Speeds Depending On Materials

ISO	Vc (m/min)	ISO	Vc (m/min)	ISO	Vc (m/min)
P1	15÷30 ★	M1	10÷25 ★	N1	10÷45 ☆
P2	15÷30 ★	M2	10÷25 ★	N2	10÷45 ☆
P3	15÷25 ★				
P4	15÷25 ★				
P7	10÷25 ★				

★ 1st choice ☆ suitable

ROLL
DIN

CARBIDE

LONG

HAND
TAPS

EG (STI)

SPECIAL
THREADS,
GAUGES

THREAD
MILLS

DIES

CENTER
DRILLS

Technical
info

TYPE: SP_025

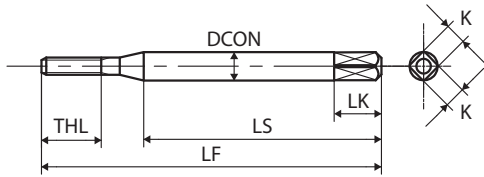

TYPE: EU_136

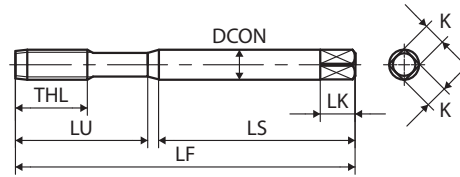

TYPE: EU_116

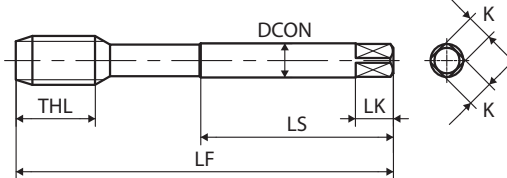

M	TCTR (tolerance)	Bored Hole Ø (mm)		Code	THCHT (chamfer)	LF (mm)	THL (mm)	LU (mm)	LS (mm)	DCON (mm)	K (mm)	LK (mm)	NOF (Lobes)	Type	Stock	
		Max	Min													
DIN 371																
M2X0.4	ISO2X(6HX)	1.86	1.8	RE2.0EBFPTB	2P	45	8	-	32	2.8	2.1	5	0(4)	025	●	Intro
	ISO3X(6GX)	1.87	1.82	RE2.0ENFPTB	2P	45	8	-	32	2.8	2.1	5	0(4)	025	●	SP
M2.5X0.45	ISO2X(6HX)	2.34	2.27	RE2.5FBFPTB	2P	50	8	15	33	2.8	2.1	5	0(4)	136	●	SL
	ISO3X(6GX)	2.37	2.31	RE2.5FNFPPTB	2P	50	8	15	33	2.8	2.1	5	0(4)	136	●	
M3X0.5	ISO2X(6HX)	2.83	2.76	RE3.0GBFPTB	2P	56	9	18	34	3.5	2.7	6	2(4)	136	●	PO
	ISO3X(6GX)	2.85	2.78	RE3.0GNFPPTB	2P	56	9	18	34	3.5	2.7	6	2(4)	136	●	
M4X0.7	ISO2X(6HX)	3.75	3.66	RE4.0IBFPTB	2P	63	13	21	38	4.5	3.4	6	2(4)	136	●	ST
	ISO3X(6GX)	3.77	3.68	RE4.0INFPPTB	2P	63	13	21	38	4.5	3.4	6	2(4)	136	●	
M5X0.8	ISO2X(6HX)	4.7	4.6	RE5.0KBFPTB	2P	70	14	25	39	6	4.9	8	2(4)	136	●	ROLL DIN
	ISO3X(6GX)	4.72	4.62	RE5.0KNFPPTB	2P	70	14	25	39	6	4.9	8	2(4)	136	●	
M6X1	ISO2X(6HX)	5.61	5.5	RE6.0MBFPTB	2P	80	15	30	45	6	4.9	8	2(4)	136	●	CARBIDE
	ISO3X(6GX)	5.65	5.54	RE6.0MNFPTB	2P	80	15	30	45	6	4.9	8	2(4)	136	●	
M8X1.25	ISO2X(6HX)	7.52	7.38	RD8.0NBFPTB	2P	90	19	35	47	8	6.2	9	3(6)	136	●	LONG
	ISO3X(6GX)	7.53	7.4	RD8.0NNFPPTB	2P	90	19	35	47	8	6.2	9	3(6)	136	●	
M10X1.5	ISO2X(6HX)	9.41	9.26	RD0100BFPTB	2P	100	23	39	52	10	8	11	4(8)	136	●	HAND TAPS
	ISO3X(6GX)	9.44	9.29	RD0100NFPTB	2P	100	23	39	52	10	8	11	4(8)	136	●	
DIN 376																
M12X1.75	ISO2X(6HX)	11.3	11.13	RG012PBFPTB	2P	110	26	-	56	9	7	10	4(8)	116	●	EG (STI)
	ISO3X(6GX)	11.33	11.16	RG012PNFPPTB	2P	110	26	-	56	9	7	10	4(8)	116	●	
M14X2	ISO2X(6HX)	13.19	13	RG014QBFPTB	2P	110	26	-	56	11	9	12	4(8)	116	●	SPECIAL THREADS, GAUGES
M16X2	ISO2X(6HX)	15.19	15	RG016QBFPTB	2P	110	26	-	56	12	9	12	4(8)	116	●	
DIN 374																
M10X1.25	ISO2X(6HX)	9.51	9.38	RM010NBFPTB	2P	100	23	-	51	7	5.5	8	4(8)	116	●	THREAD MILLS
M12X1.5	ISO2X(6HX)	11.39	11.24	RM0120BFPTB	2P	100	21	-	51	9	7	10	4(8)	116	●	
M12X1.25	ISO2X(6HX)	11.51	11.38	RM012NBFPTB	2P	100	21	-	51	9	7	10	4(8)	116	●	DIES
M14X1.5	ISO2X(6HX)	13.39	13.24	RM0140BFPTB	2P	100	21	-	51	11	9	12	4(8)	116	●	
M16X1.5	ISO2X(6HX)	15.38	15.23	RM0160BFPTB	2P	100	21	-	51	12	9	12	4(8)	116	●	CENTER DRILLS

Intro

OL+RZ/OL-RZ

MP Multi Purpose Series

Thread Forming Taps for Dry Tapping, Coated



SP

SL

PO

ST

ROLL

DIN

CARBIDE

LONG

HAND TAPS

EG (STI)

SPECIAL THREADS, GAUGES

THREAD MILLS

DIES

CENTER DRILLS

Technical info



Recommended Tapping Speeds Depending On Materials

ISO	Vc (m/min)	★	ISO	Vc (m/min)	★	ISO	Vc (m/min)	☆
P1	15÷30	★	M1	10÷25	★	N1	10÷45	☆
P2	15÷30	★	M2	10÷25	★	N2	10÷45	☆
P3	15÷25	★						
P4	15÷25	★						
P7	10÷25	★						

★ 1st choice ☆ suitable

FEATURES

Dry Series forming taps for blind and through hole application.

Specific design, HSSP substrate and suitable coating for stable and long life even in difficult condition such as dry or MQL tapping.

For steel, stainless steel and non-ferrous materials.

TYPE: EU_139

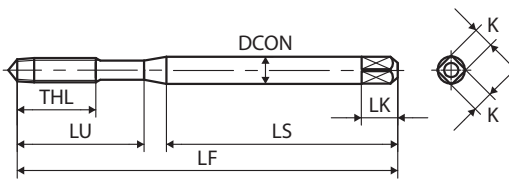

M	TCTR (tolerance)	Bored Hole Ø (mm)		Code	THCHT (chamfer)	LF (mm)	THL (mm)	LU (mm)	LS (mm)	DCON (mm)	K (mm)	LK (mm)	NOF (Lobes)	Type	Stock
		Max	Min												
DIN 371															
M3X0.5	ISO2X(6HX)	2.83	2.76	RE3.0GBHPTP	4P	56	9	18	34	3.5	2.7	6	0(4)	139	○
M4X0.7	ISO2X(6HX)	3.75	3.66	RE4.0IBHPTP	4P	63	13	21	38	4.5	3.4	6	0(4)	139	○
M5X0.8	ISO2X(6HX)	4.7	4.6	RE5.0KBHPTP	4P	70	14	25	39	6	4.9	8	0(4)	139	○
M6X1	ISO2X(6HX)	5.61	5.5	RE6.0MBHPTP	4P	80	15	30	45	6	4.9	8	0(4)	139	○

Intro

SP

SL

PO

ST

ROLL

DIN

CARBIDE

LONG

HAND
TAPS

EG (STI)

SPECIAL
THREADS,
GAUGES

THREAD
MILLS

DIES

CENTER
DRILLS

Technical
info

Intro

R+V

GP General Purpose Series

Thread Forming Taps, Coated



SP

SL

PO

ST



Recommended Tapping Speeds Depending On Materials

ISO	Vc (m/min)		ISO	Vc (m/min)		ISO	Vc (m/min)	
P1	10÷20	★	M1	5÷12	☆	N1	10÷20	☆
P2	10÷20	★				N2	10÷20	☆
P7	5÷12	☆				N3	10÷20	☆

★ 1st choice ☆ suitable

FEATURES

General purpose forming taps for blind and through hole application.

For ferrous and non-ferrous materials.

Suitable coating prevents welding and extends life.

ROLL

JIS

CARBIDE

LONG

HAND TAPS

EG (STI)

SPECIAL THREADS, GAUGES

THREAD MILLS

DIES

CENTER DRILLS

Technical info

TYPE: ROLL_010

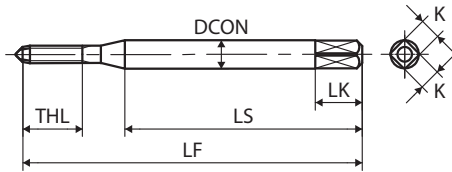

TYPE: ROLL_012

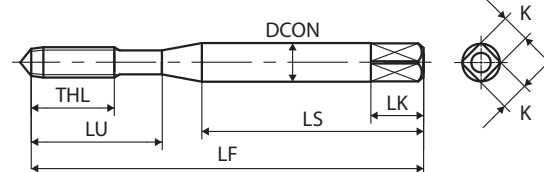

M	TCTR (tolerance)	Bored Hole Ø (mm)		Code	THCHT (chamfer)	LF (mm)	THL (mm)	LU (mm)	LS (mm)	DCON (mm)	K (mm)	LK (mm)	NOF (Lobes)	Type	Stock	Intro
		Max	Min													
JIS																
M1X0.25	G4	0.92	0.89	RVP41.0BP	4P	36	4.5	-	24	3	2.5	5	0(4)	010	○	SP
	G4	0.92	0.89	RVP41.0BB	2P	36	4.5	-	24	3	2.5	5	0(4)	010	○	
	G5(G4+13)	0.93	0.9	RVP51.0BP	4P	36	4.5	-	24	3	2.5	5	0(4)	010	○	
	G5(G4+13)	0.93	0.9	RVP51.0BB	2P	36	4.5	-	24	3	2.5	5	0(4)	010	○	
M1.2X0.25	G4	1.11	1.09	RVP41.2BP	4P	36	4.5	-	24	3	2.5	5	0(4)	010	○	SL
	G4	1.11	1.09	RVP41.2BB	2P	36	4.5	-	24	3	2.5	5	0(4)	010	○	
	G5(G4+13)	1.13	1.1	RVP51.2BP	4P	36	4.5	-	24	3	2.5	5	0(4)	010	○	
	G5(G4+13)	1.13	1.1	RVP51.2BB	2P	36	4.5	-	24	3	2.5	5	0(4)	010	○	
M1.4X0.3	G4	1.3	1.26	RVP41.4CP	4P	36	5.4	-	24	3	2.5	5	0(4)	010	○	PO
	G4	1.3	1.26	RVP41.4CB	2P	36	5.4	-	24	3	2.5	5	0(4)	010	○	
	G5(G4+13)	1.31	1.28	RVP51.4CP	4P	36	5.4	-	24	3	2.5	5	0(4)	010	○	
	G5(G4+13)	1.31	1.28	RVP51.4CB	2P	36	5.4	-	24	3	2.5	5	0(4)	010	○	
M1.6X0.35	G4	1.46	1.43	RVP41.6DP	4P	36	6.3	-	24	3	2.5	5	0(4)	010	○	ST
	G4	1.46	1.43	RVP41.6DB	2P	36	6.3	-	24	3	2.5	5	0(4)	010	○	
	G5(G4+13)	1.48	1.44	RVP51.6DP	4P	36	6.3	-	24	3	2.5	5	0(4)	010	○	
	G5(G4+13)	1.48	1.44	RVP51.6DB	2P	36	6.3	-	24	3	2.5	5	0(4)	010	○	
	G6(G4+26)	1.49	1.45	RVP61.6DB	2P	36	6.3	-	24	3	2.5	5	0(4)	010	○	
M1.7X0.35	G4	1.56	1.52	RVP41.7DP	4P	36	6.3	-	24	3	2.5	5	0(4)	010	○	JIS
	G4	1.56	1.52	RVP41.7DB	2P	36	6.3	-	24	3	2.5	5	0(4)	010	○	
	G5(G4+13)	1.58	1.54	RVP51.7DP	4P	36	6.3	-	24	3	2.5	5	0(4)	010	○	
	G5(G4+13)	1.58	1.54	RVP51.7DB	2P	36	6.3	-	24	3	2.5	5	0(4)	010	○	
	G6(G4+26)	1.59	1.55	RVP61.7DP	4P	36	6.3	-	24	3	2.5	5	0(4)	010	○	
	G6(G4+26)	1.59	1.55	RVP61.7DB	2P	36	6.3	-	24	3	2.5	5	0(4)	010	○	
M2X0.4	G4	1.83	1.79	RVP42.0EP	4P	42	7.2	-	27	3	2.5	5	0(4)	010	○	LONG
	G4	1.83	1.79	RVP42.0EB	2P	42	7.2	-	27	3	2.5	5	0(4)	010	○	
	G5(G4+13)	1.84	1.8	RVP52.0EP	4P	42	7.2	-	27	3	2.5	5	0(4)	010	○	
	G5(G4+13)	1.84	1.8	RVP52.0EB	2P	42	7.2	-	27	3	2.5	5	0(4)	010	○	
	G6(G4+26)	1.86	1.81	RVP62.0EP	4P	42	7.2	-	27	3	2.5	5	0(4)	010	○	
	G6(G4+26)	1.86	1.81	RVP62.0EB	2P	42	7.2	-	27	3	2.5	5	0(4)	010	○	
M2.3X0.4	G4	2.13	2.09	RVP42.3EP	4P	42	7.2	-	27	3	2.5	5	0(4)	010	○	HAND TAPS
	G4	2.13	2.09	RVP42.3EB	2P	42	7.2	-	27	3	2.5	5	0(4)	010	○	
	G5(G4+13)	2.14	2.1	RVP52.3EP	4P	42	7.2	-	27	3	2.5	5	0(4)	010	○	
	G5(G4+13)	2.14	2.1	RVP52.3EB	2P	42	7.2	-	27	3	2.5	5	0(4)	010	○	
M2.5X0.45	G5	2.32	2.27	RVP52.5FP	4P	46	8.1	14	29	3	2.5	5	0(4)	012	○	SPECIAL THREADS, GAUGES
	G5	2.32	2.27	RVP52.5FB	2P	46	8.1	14	29	3	2.5	5	0(4)	012	○	
	G6(G5+13)	2.34	2.29	RVP62.5FP	4P	46	8.1	14	29	3	2.5	5	0(4)	012	○	
	G6(G5+13)	2.34	2.29	RVP62.5FB	2P	46	8.1	14	29	3	2.5	5	0(4)	012	○	
M2.6X0.45	G5	2.42	2.37	RVP52.6FP	4P	46	8.1	14	29	3	2.5	5	0(4)	012	○	THREAD MILLS
	G5	2.42	2.37	RVP52.6FB	2P	46	8.1	14	29	3	2.5	5	0(4)	012	○	
	G6(G5+13)	2.44	2.39	RVP62.6FP	4P	46	8.1	14	29	3	2.5	5	0(4)	012	○	
	G6(G5+13)	2.44	2.39	RVP62.6FB	2P	46	8.1	14	29	3	2.5	5	0(4)	012	○	
M3X0.5	G5	2.8	2.75	RVP53.0GP	4P	46	9	14	26	4	3.2	6	4(4)	012	○	DIES
	G5	2.8	2.75	RVP53.0GB	2P	46	9	14	26	4	3.2	6	4(4)	012	○	
	G6(G5+13)	2.82	2.76	RVP63.0GP	4P	46	9	14	26	4	3.2	6	4(4)	012	○	
	G6(G5+13)	2.82	2.76	RVP63.0GB	2P	46	9	14	26	4	3.2	6	4(4)	012	○	
	G7(G5+26)	2.83	2.77	RVP73.0GP	4P	46	9	14	26	4	3.2	6	4(4)	012	○	
	G7(G5+26)	2.83	2.77	RVP73.0GB	2P	46	9	14	26	4	3.2	6	4(4)	012	○	
	G8(G5+39)	2.84	2.79	RVP83.0GP	4P	46	9	14	26	4	3.2	6	4(4)	012	○	CENTER DRILLS

Technical info

Forming Taps

Intro

SP

SL

PO

ST

ROLL

JIS

CARBIDE

LONG

HAND TAPS

EG (STI)

SPECIAL THREADS, GAUGES

THREAD MILLS

DIES

CENTER DRILLS

Technical info

Intro	M	TCTR (tolerance)	Bored Hole Ø (mm)		Code	THCHT (chamfer)	LF (mm)	THL (mm)	LU (mm)	LS (mm)	DCON (mm)	K (mm)	LK (mm)	NOF (Lobes)	Type	Stock
			Max	Min												
	JIS															
M4X0.7	G5	3.71	3.65	RVP54.0IP	4P	52	11	17	29	5	4	7	4(4)	012	○	
	G5	3.71	3.65	RVP54.0IB	2P	52	11	17	29	5	4	7	4(4)	012	○	
	G6	3.72	3.65	RVP64.0IP	4P	52	11	17	29	5	4	7	4(4)	012	○	
	G6	3.72	3.65	RVP64.0IB	2P	52	11	17	29	5	4	7	4(4)	012	○	
	G7(G6+13)	3.74	3.66	RVP74.0IP	4P	52	11	17	29	5	4	7	4(4)	012	○	
	G7(G6+13)	3.74	3.66	RVP74.0IB	2P	52	11	17	29	5	4	7	4(4)	012	○	
	G8(G6+26)	3.75	3.67	RVP84.0IP	4P	52	11	17	29	5	4	7	4(4)	012	○	
	G8(G6+26)	3.75	3.67	RVP84.0IB	2P	52	11	17	29	5	4	7	4(4)	012	○	
M5X0.8	G5	4.66	4.57	RVP55.0KP	4P	60	13	22	33	5.5	4.5	7	4(4)	012	○	
	G5	4.66	4.57	RVP55.0KB	2P	60	13	22	33	5.5	4.5	7	4(4)	012	○	
	G6	4.67	4.59	RVP65.0KP	4P	60	13	22	33	5.5	4.5	7	4(4)	012	○	
	G6	4.67	4.59	RVP65.0KB	2P	60	13	22	33	5.5	4.5	7	4(4)	012	○	
	G7(G6+13)	4.68	4.6	RVP75.0KP	4P	60	13	22	33	5.5	4.5	7	4(4)	012	○	
	G7(G6+13)	4.68	4.6	RVP75.0KB	2P	60	13	22	33	5.5	4.5	7	4(4)	012	○	
	G8(G6+26)	4.7	4.61	RVP85.0KP	4P	60	13	22	33	5.5	4.5	7	4(4)	012	○	
	G8(G6+26)	4.7	4.61	RVP85.0KB	2P	60	13	22	33	5.5	4.5	7	4(4)	012	○	
M6X1	G6	5.58	5.47	RVP66.0MP	4P	62	15	26	33	6	4.5	7	4(4)	012	○	
	G6	5.58	5.47	RVP66.0MB	2P	62	15	26	33	6	4.5	7	4(4)	012	○	
	G7(G6+13)	5.59	5.49	RVP76.0MP	4P	62	15	26	33	6	4.5	7	4(4)	012	○	
	G7(G6+13)	5.59	5.49	RVP76.0MB	2P	62	15	26	33	6	4.5	7	4(4)	012	○	
	G8(G7+13)	5.61	5.5	RVP86.0MP	4P	62	15	26	33	6	4.5	7	4(4)	012	○	
	G8(G7+13)	5.61	5.5	RVP86.0MB	2P	62	15	26	33	6	4.5	7	4(4)	012	○	

Intro

SP

SL

PO

ST

ROLL

JIS

CARBIDE

LONG

HAND
TAPS

EG (STI)

SPECIAL
THREADS,
GAUGES

THREAD
MILLS

DIES

CENTER
DRILLS

Technical
info

Intro

N+RZ/N-RZ

GP General Purpose Series

Thread Forming Taps for Steel



SP

SL



PO

Recommended Tapping Speeds Depending On Materials

ISO Vc (m/min)

P1 5÷15 ★

P2 5÷10 ★

ST

★ 1st choice ☆ suitable

FEATURES

General purpose forming taps for blind and through hole application.

Suitable for soft structural steel and medium-low carbon steel application.

OX treatment reduces welding troubles.

ROLL

JIS

CARBIDE

LONG

HAND TAPS

EG (STI)

SPECIAL THREADS, GAUGES

THREAD MILLS

DIES

CENTER DRILLS

Technical info

TYPE: ROLL_010

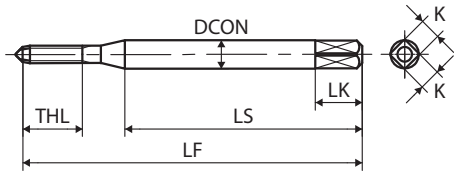

TYPE: ROLL_012

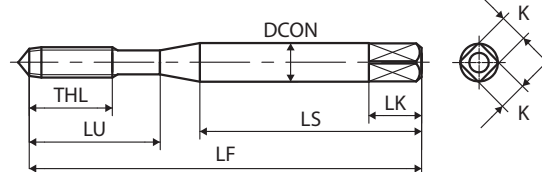

TYPE: ROLL_026

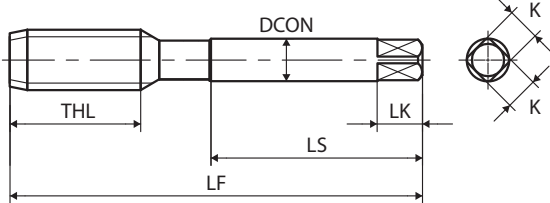

M	TCTR (tolerance)	Bored Hole Ø (mm)		Code	THCHT (chamfer)	LF (mm)	THL (mm)	LU (mm)	LS (mm)	DCON (mm)	K (mm)	LK (mm)	NOF (Lobes)	Type	Stock	Intro
		Max	Min													
JIS																
M1X0.25	G4	0.92	0.89	NRZP41.0BP	4P	36	4.5	-	24	3	2.5	5	0(4)	010	○	SP
	G4	0.92	0.89	NRZP41.0BB	2P	36	4.5	-	24	3	2.5	5	0(4)	010	○	
	G5(G4+13)	0.93	0.9	NRZP51.0BP	4P	36	4.5	-	24	3	2.5	5	0(4)	010	○	
	G5(G4+13)	0.93	0.9	NRZP51.0BB	2P	36	4.5	-	24	3	2.5	5	0(4)	010	○	
M1.2X0.25	G4	1.11	1.09	NRZP41.2BB	2P	36	4.5	-	24	3	2.5	5	0(4)	010	○	SL
	G5(G4+13)	1.13	1.1	NRZP51.2BP	4P	36	4.5	-	24	3	2.5	5	0(4)	010	○	
	G5(G4+13)	1.13	1.1	NRZP51.2BB	2P	36	4.5	-	24	3	2.5	5	0(4)	010	○	
	G4	1.11	1.09	NRZP41.2BP	4P	36	4.5	-	24	3	2.5	5	0(4)	010	○	
M1.4X0.3	G4	1.3	1.26	NRZP41.4CP	4P	36	5.4	-	24	3	2.5	5	0(4)	010	○	PO
	G4	1.3	1.26	NRZP41.4CB	2P	36	5.4	-	24	3	2.5	5	0(4)	010	○	
	G5(G4+13)	1.31	1.28	NRZP51.4CP	4P	36	5.4	-	24	3	2.5	5	0(4)	010	○	
	G5(G4+13)	1.31	1.28	NRZP51.4CB	2P	36	5.4	-	24	3	2.5	5	0(4)	010	○	
M1.6X0.35	G4	1.46	1.43	NRZP41.6DP	4P	36	6.3	-	24	3	2.5	5	0(4)	010	○	ST
	G4	1.46	1.43	NRZP41.6DB	2P	36	6.3	-	24	3	2.5	5	0(4)	010	○	
	G5(G4+13)	1.48	1.44	NRZP51.6DP	4P	36	6.3	-	24	3	2.5	5	0(4)	010	○	
	G5(G4+13)	1.48	1.44	NRZP51.6DB	2P	36	6.3	-	24	3	2.5	5	0(4)	010	○	
M1.7X0.35	G4	1.56	1.52	NRZP41.7DP	4P	36	6.3	-	24	3	2.5	5	0(4)	010	○	ROLL JIS
	G4	1.56	1.52	NRZP41.7DB	2P	36	6.3	-	24	3	2.5	5	0(4)	010	○	
	G5(G4+13)	1.58	1.54	NRZP51.7DP	4P	36	6.3	-	24	3	2.5	5	0(4)	010	○	
	G5(G4+13)	1.58	1.54	NRZP51.7DB	2P	36	6.3	-	24	3	2.5	5	0(4)	010	○	
	G6(G4+26)	1.59	1.55	NRZP61.7DP	4P	36	6.3	-	24	3	2.5	5	0(4)	010	○	
	G6(G4+26)	1.59	1.55	NRZP61.7DB	2P	36	6.3	-	24	3	2.5	5	0(4)	010	○	
M1.8X0.35	G4	1.66	1.62	NRZP41.8DP	4P	42	6.3	-	27	3	2.5	5	0(4)	010	○	CARBIDE LONG
	G4	1.66	1.62	NRZP41.8DB	2P	42	6.3	-	27	3	2.5	5	0(4)	010	○	
	G5(G4+13)	1.68	1.64	NRZP51.8DP	4P	42	6.3	-	27	3	2.5	5	0(4)	010	○	
	G5(G4+13)	1.68	1.64	NRZP51.8DB	2P	42	6.3	-	27	3	2.5	5	0(4)	010	○	
M2X0.4	G4	1.83	1.79	NRZP42.0EP	4P	42	7.2	-	27	3	2.5	5	0(4)	010	○	HAND TAPS
	G4	1.83	1.79	NRZP42.0EB	2P	42	7.2	-	27	3	2.5	5	0(4)	010	○	
	G5(G4+13)	1.84	1.8	NRZP52.0EP	4P	42	7.2	-	27	3	2.5	5	0(4)	010	○	
	G5(G4+13)	1.84	1.8	NRZP52.0EB	2P	42	7.2	-	27	3	2.5	5	0(4)	010	○	
	G6(G4+26)	1.86	1.81	NRZP62.0EP	4P	42	7.2	-	27	3	2.5	5	0(4)	010	○	
	G6(G4+26)	1.86	1.81	NRZP62.0EB	2P	42	7.2	-	27	3	2.5	5	0(4)	010	○	
M2.2X0.45	G5	2.02	1.98	NRZP52.2FP	4P	42	8.1	-	27	3	2.5	5	0(4)	010	○	SPECIAL THREADS, GAUGES
	G5	2.02	1.98	NRZP52.2FB	2P	42	8.1	-	27	3	2.5	5	0(4)	010	○	
M2.3X0.4	G4	2.13	2.09	NRZP42.3EP	4P	42	7.2	-	27	3	2.5	5	0(4)	010	○	THREAD MILLS
	G4	2.13	2.09	NRZP42.3EB	2P	42	7.2	-	27	3	2.5	5	0(4)	010	○	
	G5(G4+13)	2.14	2.1	NRZP52.3EP	4P	42	7.2	-	27	3	2.5	5	0(4)	010	○	
	G5(G4+13)	2.14	2.1	NRZP52.3EB	2P	42	7.2	-	27	3	2.5	5	0(4)	010	○	
	G6(G4+26)	2.16	2.11	NRZP62.3EP	4P	42	7.2	-	27	3	2.5	5	0(4)	010	○	
	G6(G4+26)	2.16	2.11	NRZP62.3EB	2P	42	7.2	-	27	3	2.5	5	0(4)	010	○	
M2.5X0.45	G5	2.32	2.27	NRZP52.5FP	4P	46	8.1	14	29	3	2.5	5	0(4)	012	○	DIES
	G5	2.32	2.27	NRZP52.5FB	2P	46	8.1	14	29	3	2.5	5	0(4)	012	○	
	G6(G5+13)	2.34	2.29	NRZP62.5FP	4P	46	8.1	14	29	3	2.5	5	0(4)	012	○	
	G6(G5+13)	2.34	2.29	NRZP62.5FB	2P	46	8.1	14	29	3	2.5	5	0(4)	012	○	

CENTER
DRILLSTechnical
info

Forming Taps

Intro	M	TCTR (tolerance)	Bored Hole Ø (mm)		Code	THCHT (chamfer)	LF (mm)	THL (mm)	LU (mm)	LS (mm)	DCON (mm)	K (mm)	LK (mm)	NOF (Lobes)	Type	Stock
			Max	Min												
JIS																
SP	M2.6X0.45	G5	2.42	2.37	NRZP52.6FP	4P	46	8.1	14	29	3	2.5	5	0(4)	012	○
		G5	2.42	2.37	NRZP52.6FB	2P	46	8.1	14	29	3	2.5	5	0(4)	012	○
		G6(G5+13)	2.44	2.39	NRZP62.6FP	4P	46	8.1	14	29	3	2.5	5	0(4)	012	○
		G6(G5+13)	2.44	2.39	NRZP62.6FB	2P	46	8.1	14	29	3	2.5	5	0(4)	012	○
SL	M3X0.5	G5	2.8	2.75	NRZP53.0GP	4P	46	9	14	26	4	3.2	6	4(4)	012	○
		G5	2.8	2.75	NRZP53.0GB	2P	46	9	14	26	4	3.2	6	4(4)	012	○
		G6(G5+13)	2.82	2.76	NRZP63.0GP	4P	46	9	14	26	4	3.2	6	4(4)	012	○
		G6(G5+13)	2.82	2.76	NRZP63.0GB	2P	46	9	14	26	4	3.2	6	4(4)	012	○
PO	M3X0.5	G7(G5+26)	2.83	2.77	NRZP73.0GP	4P	46	9	14	26	4	3.2	6	4(4)	012	○
		G7(G5+26)	2.83	2.77	NRZP73.0GB	2P	46	9	14	26	4	3.2	6	4(4)	012	○
		G8(G5+39)	2.84	2.79	NRZP83.0GP	4P	46	9	14	26	4	3.2	6	4(4)	012	○
		G8(G5+39)	2.84	2.79	NRZP83.0GB	2P	46	9	14	26	4	3.2	6	4(4)	012	○
ROLL JIS	M3.5X0.6	G5	3.25	3.19	NRZP53.5HP	4P	52	11	16	29	5	4	7	4(4)	012	○
		G5	3.25	3.19	NRZP53.5HB	2P	52	11	16	29	5	4	7	4(4)	012	○
		G6(G5+13)	3.26	3.2	NRZP63.5HP	4P	52	11	16	29	5	4	7	4(4)	012	○
		G6(G5+13)	3.26	3.2	NRZP63.5HB	2P	52	11	16	29	5	4	7	4(4)	012	○
		G7(G5+26)	3.28	3.21	NRZP73.5HP	4P	52	11	16	29	5	4	7	4(4)	012	○
		G7(G5+26)	3.28	3.21	NRZP73.5HB	2P	52	11	16	29	5	4	7	4(4)	012	○
CARBIDE LONG	M4X0.7	G5	3.71	3.65	NRZP54.0IP	4P	52	11	17	29	5	4	7	4(4)	012	○
		G5	3.71	3.65	NRZP54.0IB	2P	52	11	17	29	5	4	7	4(4)	012	○
		G6	3.72	3.65	NRZP64.0IP	4P	52	11	17	29	5	4	7	4(4)	012	○
		G6	3.72	3.65	NRZP64.0IB	2P	52	11	17	29	5	4	7	4(4)	012	○
		G7(G6+13)	3.74	3.66	NRZP74.0IP	4P	52	11	17	29	5	4	7	4(4)	012	○
		G7(G6+13)	3.74	3.66	NRZP74.0IB	2P	52	11	17	29	5	4	7	4(4)	012	○
		G8(G6+26)	3.75	3.67	NRZP84.0IP	4P	52	11	17	29	5	4	7	4(4)	012	○
		G8(G6+26)	3.75	3.67	NRZP84.0IB	2P	52	11	17	29	5	4	7	4(4)	012	○
HAND TAPS EG (STI)	M5X0.8	G5	4.66	4.57	NRZP55.0KP	4P	60	13	22	33	5.5	4.5	7	4(4)	012	○
		G5	4.66	4.57	NRZP55.0KB	2P	60	13	22	33	5.5	4.5	7	4(4)	012	○
		G6	4.67	4.59	NRZP65.0KP	4P	60	13	22	33	5.5	4.5	7	4(4)	012	○
		G6	4.67	4.59	NRZP65.0KB	2P	60	13	22	33	5.5	4.5	7	4(4)	012	○
		G7(G6+13)	4.68	4.6	NRZP75.0KP	4P	60	13	22	33	5.5	4.5	7	4(4)	012	○
		G7(G6+13)	4.68	4.6	NRZP75.0KB	2P	60	13	22	33	5.5	4.5	7	4(4)	012	○
		G8(G6+26)	4.7	4.61	NRZP85.0KP	4P	60	13	22	33	5.5	4.5	7	4(4)	012	○
		G8(G6+26)	4.7	4.61	NRZP85.0KB	2P	60	13	22	33	5.5	4.5	7	4(4)	012	○
SPECIAL THREADS, GAUGES THREAD MILLS	M6X1	G5	5.57	5.46	NRZP56.0MP	4P	62	15	26	33	6	4.5	7	4(4)	012	○
		G5	5.57	5.46	NRZP56.0MB	2P	62	15	26	33	6	4.5	7	4(4)	012	○
		G6	5.58	5.47	NRZP66.0MP	4P	62	15	26	33	6	4.5	7	4(4)	012	○
		G6	5.58	5.47	NRZP66.0MB	2P	62	15	26	33	6	4.5	7	4(4)	012	○
		G7(G6+13)	5.59	5.49	NRZP76.0MP	4P	62	15	26	33	6	4.5	7	4(4)	012	○
		G7(G6+13)	5.59	5.49	NRZP76.0MB	2P	62	15	26	33	6	4.5	7	4(4)	012	○
DIES	M7X1	G7	6.59	6.48	NRZM77.0MP	4P	70	19	-	36	6.2	5	8	4(4)	026	○
		G7	6.59	6.48	NRZM77.0MB	2P	70	19	-	36	6.2	5	8	4(4)	026	○
CENTER DRILLS	M8X1.25	G7	7.49	7.37	NRZM78.0NP	4P	70	19	-	36	6.2	5	8	3(6)	026	○
		G7	7.49	7.37	NRZM78.0NB	2P	70	19	-	36	6.2	5	8	3(6)	026	○
		G8(G7+13)	7.51	7.37	NRZM88.0NP	4P	70	19	-	36	6.2	5	8	3(6)	026	○
		G8(G7+13)	7.51	7.37	NRZM88.0NB	2P	70	19	-	36	6.2	5	8	3(6)	026	○

Technical
info

M	TCTR (tolerance)	Bored Hole Ø (mm)		Code	THCHT (chamfer)	LF (mm)	THL (mm)	LU (mm)	LS (mm)	DCON (mm)	K (mm)	LK (mm)	NOF (Lobes)	Type	Stock	Intro
		Max	Min													
JIS																
M10X1.5	G7	9.38	9.22	NRZM70100P	4P	75	23	-	38	7	5.5	8	4(8)	026	○	SP
	G7	9.38	9.22	NRZM70100B	2P	75	23	-	38	7	5.5	8	4(8)	026	○	
	G8(G7+13)	9.39	9.23	NRZM80100P	4P	75	23	-	38	7	5.5	8	4(8)	026	○	
	G8(G7+13)	9.39	9.23	NRZM80100B	2P	75	23	-	38	7	5.5	8	4(8)	026	○	
M12X1.75	G8	11.28	11.09	NRZM8012PP	4P	82	26	-	42	8.5	6.5	9	4(8)	026	○	SL
	G8	11.28	11.09	NRZM8012PB	2P	82	26	-	42	8.5	6.5	9	4(8)	026	○	
	G9(G8+13)	11.29	11.11	NRZM9012PP	4P	82	26	-	42	8.5	6.5	9	4(8)	026	○	
	G9(G8+13)	11.29	11.11	NRZM9012PB	2P	82	26	-	42	8.5	6.5	9	4(8)	026	○	
M14X2	G9	13.18	12.97	NRZM9014QP	4P	88	26	-	45	10.5	8	11	4(8)	026	○	PO
	G9	13.18	12.97	NRZM9014QB	2P	88	26	-	45	10.5	8	11	4(8)	026	○	
	G10	13.19	12.98	NRZM0014QP	4P	88	26	-	45	10.5	8	11	4(8)	026	○	
	G10	13.19	12.98	NRZM0014QB	2P	88	26	-	45	10.5	8	11	4(8)	026	○	
M16X2	G9	15.18	14.96	NRZM9016QP	4P	95	26	-	48	12.5	10	13	4(8)	026	○	ST
	G9	15.18	14.96	NRZM9016QB	2P	95	26	-	48	12.5	10	13	4(8)	026	○	
	G10	15.19	14.97	NRZM0016QP	4P	95	26	-	48	12.5	10	13	4(8)	026	○	
	G10	15.19	14.97	NRZM0016QB	2P	95	26	-	48	12.5	10	13	4(8)	026	○	
ROLL																
JIS																
MF	TCTR (tolerance)	Bored Hole Ø (mm)		Code	THCHT (chamfer)	LF (mm)	THL (mm)	LU (mm)	LS (mm)	DCON (mm)	K (mm)	LK (mm)	NOF (Lobes)	Type	Stock	CARBIDE
JIS																
M2X0.25	G4	1.91	1.89	NRZM42.0BP	4P	42	4.5	-	27	3	2.5	5	0(4)	010	○	LONG
	G4	1.91	1.89	NRZM42.0BB	2P	42	4.5	-	27	3	2.5	5	0(4)	010	○	
	G5(G4+13)	1.93	1.9	NRZM52.0BP	4P	42	4.5	-	27	3	2.5	5	0(4)	010	○	
	G5(G4+13)	1.93	1.9	NRZM52.0BB	2P	42	4.5	-	27	3	2.5	5	0(4)	010	○	
M2.5X0.35	G5	2.37	2.36	NRZM52.5DP	4P	46	6.3	14	29	3	2.5	5	0(4)	012	○	HAND TAPS
	G5	2.37	2.36	NRZM52.5DB	2P	46	6.3	14	29	3	2.5	5	0(4)	012	○	
M2.6X0.35	G5	2.42	2.4	NRZM52.6DP	4P	46	6.3	14	29	3	2.5	5	0(4)	012	○	EG (STI)
	G5	2.42	2.4	NRZM52.6DB	2P	46	6.3	14	29	3	2.5	5	0(4)	012	○	
M3X0.35	G5	2.86	2.79	NRZM53.0DP	4P	46	6.5	14	26	4	3.2	6	4(4)	012	○	SPECIAL THREADS, GAUGES
	G5	2.86	2.79	NRZM53.0DB	2P	46	6.5	14	26	4	3.2	6	4(4)	012	○	
M4X0.5	G5	3.8	3.75	NRZM54.0GP	4P	52	9	17	29	5	4	7	4(4)	012	○	THREAD MILLS
	G5	3.8	3.75	NRZM54.0GB	2P	52	9	17	29	5	4	7	4(4)	012	○	
	G6	3.81	3.76	NRZM64.0GP	4P	52	9	17	29	5	4	7	4(4)	012	○	
	G6	3.81	3.76	NRZM64.0GB	2P	52	9	17	29	5	4	7	4(4)	012	○	
M5X0.5	G7(G6+13)	3.82	3.77	NRZM74.0GB	2P	52	9	17	29	5	4	7	4(4)	012	○	
	G6	4.81	4.76	NRZM65.0GP	4P	60	9	22	33	5.5	4.5	7	4(4)	012	○	
M6X0.75	G6	4.81	4.76	NRZM65.0GB	2P	60	9	22	33	5.5	4.5	7	4(4)	012	○	
	G6	5.69	5.61	NRZM66.0JP	4P	62	15	26	33	6	4.5	7	4(4)	012	○	
M6X0.5	G6	5.69	5.61	NRZM66.0JB	2P	62	15	26	33	6	4.5	7	4(4)	012	○	
	G7(G6+13)	5.7	5.62	NRZM76.0JP	4P	62	15	26	33	6	4.5	7	4(4)	012	○	
	G7(G6+13)	5.7	5.62	NRZM76.0JB	2P	62	15	26	33	6	4.5	7	4(4)	012	○	
M6X0.5	G6	5.81	5.76	NRZM66.0GP	4P	62	9	26	33	6	4.5	7	4(4)	012	○	DIES
	G6	5.81	5.76	NRZM66.0GB	2P	62	9	26	33	6	4.5	7	4(4)	012	○	
M7X0.75	G7	6.7	6.62	NRZM77.0JP	4P	70	19	-	36	6.2	5	8	4(4)	026	○	CENTER DRILLS
	G7	6.7	6.62	NRZM77.0JB	2P	70	19	-	36	6.2	5	8	4(4)	026	○	
M8X1	G7	7.59	7.48	NRZM78.0MP	4P	70	19	-	36	6.2	5	8	3(6)	026	○	CENTER DRILLS
	G7	7.59	7.48	NRZM78.0MB	2P	70	19	-	36	6.2	5	8	3(6)	026	○	

Forming Taps

Intro

	MF	TCTR (tolerance)	Bored Hole Ø (mm)		Code	THCHT (chamfer)	LF (mm)	THL (mm)	LU (mm)	LS (mm)	DCON (mm)	K (mm)	LK (mm)	NOF (Lobes)	Type	Stock
			Max	Min												
	JIS															
SP	M8X0.75	G7	7.7	7.62	NRZM78.0JP	4P	70	19	-	36	6.2	5	8	3(6)	026	○
		G7	7.7	7.62	NRZM78.0JB	2P	70	19	-	36	6.2	5	8	3(6)	026	○
SL	M10X1.25	G7	9.49	9.35	NRZM7010NP	4P	75	23	-	38	7	5.5	8	4(8)	026	○
		G7	9.49	9.35	NRZM7010NB	2P	75	23	-	38	7	5.5	8	4(8)	026	○
		G8(G7+13)	9.5	9.37	NRZM8010NP	4P	75	23	-	38	7	5.5	8	4(8)	026	○
		G8(G7+13)	9.5	9.37	NRZM8010NB	2P	75	23	-	38	7	5.5	8	4(8)	026	○
PO	M10X1	G7	9.59	9.48	NRZM7010MP	4P	75	23	-	38	7	5.5	8	4(8)	026	○
		G7	9.59	9.48	NRZM7010MB	2P	75	23	-	38	7	5.5	8	4(8)	026	○
ST	M12X1.5	G8	11.38	11.22	NRZM80120P	4P	82	26	-	42	8.5	6.5	9	4(8)	026	○
		G8	11.38	11.22	NRZM80120B	2P	82	26	-	42	8.5	6.5	9	4(8)	026	○
		G9(G8+13)	11.39	11.23	NRZM90120P	4P	82	26	-	42	8.5	6.5	9	4(8)	026	○
		G9(G8+13)	11.39	11.23	NRZM90120B	2P	82	26	-	42	8.5	6.5	9	4(8)	026	○
ROLL JIS	M12X1.25	G8	11.49	11.35	NRZM8012NP	4P	82	26	-	42	8.5	6.5	9	4(8)	026	○
		G8	11.49	11.35	NRZM8012NB	2P	82	26	-	42	8.5	6.5	9	4(8)	026	○
		G9	11.5	11.36	NRZM9012NP	4P	82	26	-	42	8.5	6.5	9	4(8)	026	○
		G9	11.5	11.36	NRZM9012NB	2P	82	26	-	42	8.5	6.5	9	4(8)	026	○
CARBIDE	M12X1	G7	11.58	11.47	NRZM7012MP	4P	82	26	-	42	8.5	6.5	9	4(8)	026	○
		G7	11.58	11.47	NRZM7012MB	2P	82	26	-	42	8.5	6.5	9	4(8)	026	○
LONG	M14X1.5	G9	13.39	13.22	NRZM90140P	4P	88	26	-	45	10.5	8	11	4(8)	026	○
		G9	13.39	13.22	NRZM90140B	2P	88	26	-	45	10.5	8	11	4(8)	026	○
HAND TAPS	M14X1	G8	13.59	13.48	NRZM8014MP	4P	88	26	-	45	10.5	8	11	4(8)	026	○
		G8	13.59	13.48	NRZM8014MB	2P	88	26	-	45	10.5	8	11	4(8)	026	○
EG (STI)	M16X1.5	G9	15.38	15.22	NRZM90160P	4P	95	26	-	48	12.5	10	13	4(8)	026	○
		G9	15.38	15.22	NRZM90160B	2P	95	26	-	48	12.5	10	13	4(8)	026	○
		G8	15.59	15.48	NRZM8016MP	4P	95	26	-	48	12.5	10	13	4(8)	026	○
		G8	15.59	15.48	NRZM8016MB	2P	95	26	-	48	12.5	10	13	4(8)	026	○
SPECIAL THREADS, GAUGES	M18X1.5	G10	17.4	17.24	NRZM00180P	4P	100	33	-	51	14	11	14	4(8)	026	○
		G9	19.37	19.21	NRZM90200P	4P	105	33	-	50	15	12	15	4(8)	026	○
		G9	19.37	19.21	NRZM90200B	2P	105	33	-	50	15	12	15	4(8)	026	○
		G10	19.39	19.22	NRZM00200P	4P	105	33	-	50	15	12	15	4(8)	026	○
		G10	19.39	19.22	NRZM00200B	2P	105	33	-	50	15	12	15	4(8)	026	○
THREAD MILLS	5/16-18UNC	G7	7.38	7.23	NRZM7U050P	4P	70	19	-	36	6.2	5	8	3(6)	026	○
		G7	7.38	7.23	NRZM7U050B	2P	70	19	-	36	6.2	5	8	3(6)	026	○
DIES	7/16-14UNC	G8	10.4	10.2	NRZM8U07QP	4P	82	26	-	42	8.5	6.5	9	4(8)	026	○
		G8	10.4	10.2	NRZM8U07QB	2P	82	26	-	42	8.5	6.5	9	4(8)	026	○
CENTER DRILLS	1/2-13UNC	G8	11.92	11.7	NRZM8U08RP	4P	88	26	-	45	10.5	8	11	4(8)	026	○
		G8	11.92	11.7	NRZM8U08RB	2P	88	26	-	45	10.5	8	11	4(8)	026	○
TECHNICAL INFO	UNC	TCTR (tolerance)	Bored Hole Ø (mm)		Code	THCHT (chamfer)	LF (mm)	THL (mm)	LU (mm)	LS (mm)	DCON (mm)	K (mm)	LK (mm)	NOF (Lobes)	Type	Stock
			Max	Min												
	JIS															
	No.4-40UNC	G5	2.61	2.54	NRZM5UN4HB	2P	46	9	14	25	4	3.2	6	0(4)	012	○
	No.6-32UNC	G6	3.21	3.12	NRZM6UN6JB	2P	52	11	17	27	5	4	7	2(4)	012	○

Technical info

UNF	TCTR (tolerance)	Bored Hole Ø (mm)		Code	THCHT (chamfer)	LF (mm)	THL (mm)	LU (mm)	LS (mm)	DCON (mm)	K (mm)	LK (mm)	NOF (Lobes)	Type	Stock
		Max	Min												
JIS															
3/8-24UNF	G7	9.1	8.99	NRZM7U06MP	4P	75	23	-	38	7	5.5	8	3(6)	026	○
	G7	9.1	8.99	NRZM7U06MB	2P	75	23	-	38	7	5.5	8	3(6)	026	○
7/16-20UNF	G8	10.62	10.48	NRZM8U07NP	4P	82	26	-	42	8.5	6.5	9	4(8)	026	○
	G8	10.62	10.48	NRZM8U07NB	2P	82	26	-	42	8.5	6.5	9	4(8)	026	○
1/2-20UNF	G8	12.2	12.06	NRZM8U08NP	4P	88	26	-	45	10.5	8	11	4(8)	026	○
	G8	12.2	12.06	NRZM8U08NB	2P	88	26	-	45	10.5	8	11	4(8)	026	○

Intro

SP

SL

PO

ST

ROLL

JIS

CARBIDE

LONG

HAND
TAPS

EG (STI)

SPECIAL
THREADS,
GAUGESTHREAD
MILLS

DIES

CENTER
DRILLSTechnical
info

Intro

N+RS/N-RS

GP General Purpose Series

Thread Forming Taps for Non-Ferrous Materials



SP

SL



PO

Recommended Tapping Speeds Depending On Materials

ISO	Vc (m/min)
N1	5÷15 ★
N2	5÷15 ★
N3	5÷15 ★

★ 1st choice ☆ suitable

ST

ROLL

JIS

CARBIDE

LONG

HAND TAPS

EG (STI)

SPECIAL THREADS, GAUGES

THREAD MILLS

DIES

CENTER DRILLS

Technical info

FEATURES

General purpose forming taps for blind and through hole application.

Suitable for non-ferrous materials.

NI treatment improves tool life.

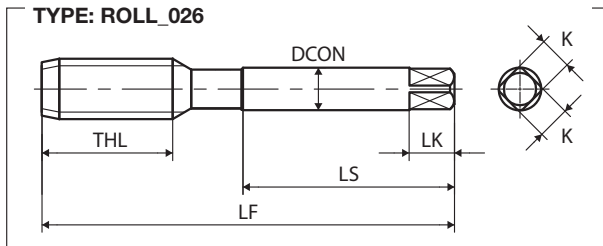
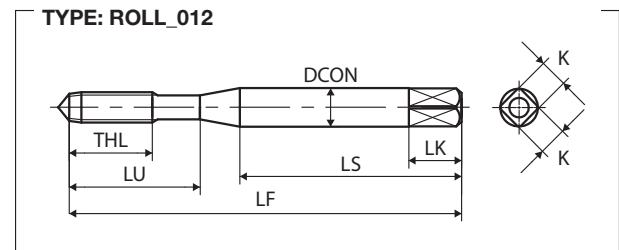
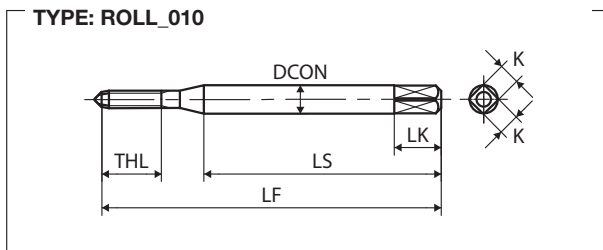

M	TCTR (tolerance)	Bored Hole Ø (mm)		Code	THCHT (chamfer)	LF (mm)	THL (mm)	LU (mm)	LS (mm)	DCON (mm)	K (mm)	LK (mm)	NOF (Lobes)	Type	Stock
		Max	Min												
JIS															
M1X0.25	G4	0.92	0.89	NRSP41.0BP	4P	36	4.5	-	24	3	2.5	5	0(4)	010	○
	G4	0.92	0.89	NRSP41.0BB	2P	36	4.5	-	24	3	2.5	5	0(4)	010	○
	G5(G4+13)	0.93	0.9	NRSP51.0BP	4P	36	4.5	-	24	3	2.5	5	0(4)	010	○
	G5(G4+13)	0.93	0.9	NRSP51.0BB	2P	36	4.5	-	24	3	2.5	5	0(4)	010	○
M1.2X0.25	G4	1.11	1.09	NRSP41.2BP	4P	36	4.5	-	24	3	2.5	5	0(4)	010	○
	G4	1.11	1.09	NRSP41.2BB	2P	36	4.5	-	24	3	2.5	5	0(4)	010	○
	G5(G4+13)	1.13	1.1	NRSP51.2BP	4P	36	4.5	-	24	3	2.5	5	0(4)	010	○
	G5(G4+13)	1.13	1.1	NRSP51.2BB	2P	36	4.5	-	24	3	2.5	5	0(4)	010	○
M1.4X0.3	G4	1.3	1.26	NRSP41.4CP	4P	36	5.4	-	24	3	2.5	5	0(4)	010	○
	G4	1.3	1.26	NRSP41.4CB	2P	36	5.4	-	24	3	2.5	5	0(4)	010	○
	G5(G4+13)	1.31	1.28	NRSP51.4CP	4P	36	5.4	-	24	3	2.5	5	0(4)	010	○
	G5(G4+13)	1.31	1.28	NRSP51.4CB	2P	36	5.4	-	24	3	2.5	5	0(4)	010	○

M	TCTR (tolerance)	Bored Hole Ø (mm)		Code	THCHT (chamfer)	LF (mm)	THL (mm)	LU (mm)	LS (mm)	DCON (mm)	K (mm)	LK (mm)	NOF (Lobes)	Type	Stock	Intro
		Max	Min													
JIS																
M1.6X0.35	G4	1.46	1.43	NRSP41.6DP	4P	36	6.3	-	24	3	2.5	5	0(4)	010	○	SP
	G4	1.46	1.43	NRSP41.6DB	2P	36	6.3	-	24	3	2.5	5	0(4)	010	○	
	G5(G4+13)	1.48	1.44	NRSP51.6DP	4P	36	6.3	-	24	3	2.5	5	0(4)	010	○	SL
	G5(G4+13)	1.48	1.44	NRSP51.6DB	2P	36	6.3	-	24	3	2.5	5	0(4)	010	○	
M1.7X0.35	G4	1.56	1.52	NRSP41.7DP	4P	36	6.3	-	24	3	2.5	5	0(4)	010	○	PO
	G4	1.56	1.52	NRSP41.7DB	2P	36	6.3	-	24	3	2.5	5	0(4)	010	○	
	G5(G4+13)	1.58	1.54	NRSP51.7DP	4P	36	6.3	-	24	3	2.5	5	0(4)	010	○	ST
	G5(G4+13)	1.58	1.54	NRSP51.7DB	2P	36	6.3	-	24	3	2.5	5	0(4)	010	○	
	G6(G4+26)	1.59	1.55	NRSP61.7DP	4P	36	6.3	-	24	3	2.5	5	0(4)	010	○	
G6(G4+26)	1.59	1.55	NRSP61.7DB	2P	36	6.3	-	24	3	2.5	5	0(4)	010	○		
M1.8X0.35	G4	1.66	1.62	NRSP41.8DP	4P	42	6.3	-	27	3	2.5	5	0(4)	010	○	ROLL
	G4	1.66	1.62	NRSP41.8DB	2P	42	6.3	-	27	3	2.5	5	0(4)	010	○	
	G5(G4+13)	1.68	1.64	NRSP51.8DP	4P	42	6.3	-	27	3	2.5	5	0(4)	010	○	JIS
	G5(G4+13)	1.68	1.64	NRSP51.8DB	2P	42	6.3	-	27	3	2.5	5	0(4)	010	○	
M2X0.4	G4	1.83	1.79	NRSP42.0EP	4P	42	7.2	-	27	3	2.5	5	0(4)	010	○	CARBIDE
	G4	1.83	1.79	NRSP42.0EB	2P	42	7.2	-	27	3	2.5	5	0(4)	010	○	
	G5(G4+13)	1.84	1.8	NRSP52.0EP	4P	42	7.2	-	27	3	2.5	5	0(4)	010	○	LONG
	G5(G4+13)	1.84	1.8	NRSP52.0EB	2P	42	7.2	-	27	3	2.5	5	0(4)	010	○	
	G6(G4+26)	1.86	1.81	NRSP62.0EP	4P	42	7.2	-	27	3	2.5	5	0(4)	010	○	
	G6(G4+26)	1.86	1.81	NRSP62.0EB	2P	42	7.2	-	27	3	2.5	5	0(4)	010	○	
M2.3X0.4	G4	2.13	2.09	NRSP42.3EP	4P	42	7.2	-	27	3	2.5	5	0(4)	010	○	HAND TAPS
	G4	2.13	2.09	NRSP42.3EB	2P	42	7.2	-	27	3	2.5	5	0(4)	010	○	
	G5(G4+13)	2.14	2.1	NRSP52.3EP	4P	42	7.2	-	27	3	2.5	5	0(4)	010	○	EG (STI)
	G5(G4+13)	2.14	2.1	NRSP52.3EB	2P	42	7.2	-	27	3	2.5	5	0(4)	010	○	
	G6(G4+26)	2.16	2.11	NRSP62.3EP	4P	42	7.2	-	27	3	2.5	5	0(4)	010	○	
	G6(G4+26)	2.16	2.11	NRSP62.3EB	2P	42	7.2	-	27	3	2.5	5	0(4)	010	○	
M2.5X0.45	G5	2.32	2.27	NRSP52.5FP	4P	46	8.1	14	29	3	2.5	5	0(4)	012	○	SPECIAL THREADS, GAUGES
	G5	2.32	2.27	NRSP52.5FB	2P	46	8.1	14	29	3	2.5	5	0(4)	012	○	
	G6(G5+13)	2.34	2.29	NRSP62.5FP	4P	46	8.1	14	29	3	2.5	5	0(4)	012	○	THREAD MILLS
	G6(G5+13)	2.34	2.29	NRSP62.5FB	2P	46	8.1	14	29	3	2.5	5	0(4)	012	○	
M2.6X0.45	G5	2.42	2.37	NRSP52.6FP	4P	46	8.1	14	29	3	2.5	5	0(4)	012	○	DIES
	G5	2.42	2.37	NRSP52.6FB	2P	46	8.1	14	29	3	2.5	5	0(4)	012	○	
	G6(G5+13)	2.44	2.39	NRSP62.6FP	4P	46	8.1	14	29	3	2.5	5	0(4)	012	○	CENTER DRILLS
	G6(G5+13)	2.44	2.39	NRSP62.6FB	2P	46	8.1	14	29	3	2.5	5	0(4)	012	○	
M3X0.5	G5	2.8	2.75	NRSP53.0GP	4P	46	9	14	26	4	3.2	6	1(4)	012	○	DIES
	G5	2.8	2.75	NRSP53.0GB	2P	46	9	14	26	4	3.2	6	1(4)	012	○	
	G6(G5+13)	2.82	2.76	NRSP63.0GP	4P	46	9	14	26	4	3.2	6	1(4)	012	○	THREAD MILLS
	G6(G5+13)	2.82	2.76	NRSP63.0GB	2P	46	9	14	26	4	3.2	6	1(4)	012	○	
	G7(G5+26)	2.83	2.77	NRSP73.0GP	4P	46	9	14	26	4	3.2	6	1(4)	012	○	DIES
	G7(G5+26)	2.83	2.77	NRSP73.0GB	2P	46	9	14	26	4	3.2	6	1(4)	012	○	
	G8(G5+39)	2.84	2.79	NRSP83.0GP	4P	46	9	14	26	4	3.2	6	1(4)	012	○	
G8(G5+39)	2.84	2.79	NRSP83.0GB	2P	46	9	14	26	4	3.2	6	1(4)	012	○		
M3.5X0.6	G5	3.25	3.19	NRSP53.5HP	4P	52	11	16	29	5	4	7	1(4)	012	○	DIES
	G5	3.25	3.19	NRSP53.5HB	2P	52	11	16	29	5	4	7	1(4)	012	○	
	G6(G5+13)	3.26	3.2	NRSP63.5HP	4P	52	11	16	29	5	4	7	1(4)	012	○	CENTER DRILLS
	G6(G5+13)	3.26	3.2	NRSP63.5HB	2P	52	11	16	29	5	4	7	1(4)	012	○	
	G7(G5+26)	3.28	3.21	NRSP73.5HP	4P	52	11	16	29	5	4	7	1(4)	012	○	

Forming Taps

Intro

SP

SL

PO

ST

ROLL

JIS

CARBIDE

LONG

HAND
TAPS

EG (STI)

SPECIAL
THREADS,
GAUGES

THREAD
MILLS

DIES

CENTER
DRILLS

Technical
info

Intro	M	TCTR (tolerance)		Bored Hole Ø (mm)		Code	THCHT (chamfer)	LF (mm)	THL (mm)	LU (mm)	LS (mm)	DCON (mm)	K (mm)	LK (mm)	NOF (Lobes)	Type	Stock
		Max	Min	Max	Min												
JIS																	
M4X0.7	G5	3.71	3.65	NRSP54.0IP	4P	52	11	17	29	5	4	7	1(4)	012	○		
	G5	3.71	3.65	NRSP54.0IB	2P	52	11	17	29	5	4	7	1(4)	012	○		
	G6	3.72	3.65	NRSP64.0IP	4P	52	11	17	29	5	4	7	1(4)	012	○		
	G6	3.72	3.65	NRSP64.0IB	2P	52	11	17	29	5	4	7	1(4)	012	○		
	G7(G6+13)	3.74	3.66	NRSP74.0IP	4P	52	11	17	29	5	4	7	1(4)	012	○		
	G7(G6+13)	3.74	3.66	NRSP74.0IB	2P	52	11	17	29	5	4	7	1(4)	012	○		
	G8(G6+26)	3.75	3.67	NRSP84.0IP	4P	52	11	17	29	5	4	7	1(4)	012	○		
	G8(G6+26)	3.75	3.67	NRSP84.0IB	2P	52	11	17	29	5	4	7	1(4)	012	○		
M5X0.8	G5	4.66	4.57	NRSP55.0KP	4P	60	13	22	33	5.5	4.5	7	1(4)	012	○		
	G5	4.66	4.57	NRSP55.0KB	2P	60	13	22	33	5.5	4.5	7	1(4)	012	○		
	G6	4.67	4.59	NRSP65.0KP	4P	60	13	22	33	5.5	4.5	7	1(4)	012	○		
	G6	4.67	4.59	NRSP65.0KB	2P	60	13	22	33	5.5	4.5	7	1(4)	012	○		
	G7(G6+13)	4.68	4.6	NRSP75.0KP	4P	60	13	22	33	5.5	4.5	7	1(4)	012	○		
	G7(G6+13)	4.68	4.6	NRSP75.0KB	2P	60	13	22	33	5.5	4.5	7	1(4)	012	○		
	G8(G6+26)	4.7	4.61	NRSP85.0KB	2P	60	13	22	33	5.5	4.5	7	1(4)	012	○		
	M6X1	G5	5.57	5.46	NRSP56.0MP	4P	62	15	26	33	6	4.5	7	1(4)	012	○	
G5		5.57	5.46	NRSP56.0MB	2P	62	15	26	33	6	4.5	7	1(4)	012	○		
G6		5.58	5.47	NRSP66.0MP	4P	62	15	26	33	6	4.5	7	1(4)	012	○		
G6		5.58	5.47	NRSP66.0MB	2P	62	15	26	33	6	4.5	7	1(4)	012	○		
G7(G6+13)		5.59	5.49	NRSP76.0MP	4P	62	15	26	33	6	4.5	7	1(4)	012	○		
G7(G6+13)		5.59	5.49	NRSP76.0MB	2P	62	15	26	33	6	4.5	7	1(4)	012	○		
G8(G7+13)		5.61	5.5	NRSP86.0MP	4P	62	15	26	33	6	4.5	7	1(4)	012	○		
G8(G7+13)		5.61	5.5	NRSP86.0MB	2P	62	15	26	33	6	4.5	7	1(4)	012	○		
M7X1	G6	6.58	6.47	NRSM67.0MP	4P	70	19	-	36	6.2	5	8	1(4)	026	○		
	G6	6.58	6.47	NRSM67.0MB	2P	70	19	-	36	6.2	5	8	1(4)	026	○		
	G7	6.59	6.48	NRSM77.0MP	4P	70	19	-	36	6.2	5	8	1(4)	026	○		
	G7	6.59	6.48	NRSM77.0MB	2P	70	19	-	36	6.2	5	8	1(4)	026	○		
M8X1.25	G7	7.49	7.37	NRSM78.0NP	4P	70	19	-	36	6.2	5	8	1(6)	026	○		
	G7	7.49	7.37	NRSM78.0NB	2P	70	19	-	36	6.2	5	8	1(6)	026	○		
	G8(G7+13)	7.51	7.37	NRSM88.0NP	4P	70	19	-	36	6.2	5	8	1(6)	026	○		
	G8(G7+13)	7.51	7.37	NRSM88.0NB	2P	70	19	-	36	6.2	5	8	1(6)	026	○		
M10X1.5	G7	9.38	9.22	NRSM70100P	4P	75	23	-	38	7	5.5	8	1(6)	026	○		
	G7	9.38	9.22	NRSM70100B	2P	75	23	-	38	7	5.5	8	1(6)	026	○		
	G8(G7+13)	9.39	9.23	NRSM80100P	4P	75	23	-	38	7	5.5	8	1(6)	026	○		
	G8(G7+13)	9.39	9.23	NRSM80100B	2P	75	23	-	38	7	5.5	8	1(6)	026	○		
M12X1.75	G8	11.28	11.09	NRSM8012PP	4P	82	26	-	42	8.5	6.5	9	1(6)	026	○		
	G8	11.28	11.09	NRSM8012PB	2P	82	26	-	42	8.5	6.5	9	1(6)	026	○		
	G9(G8+13)	11.29	11.11	NRSM9012PP	4P	82	26	-	42	8.5	6.5	9	1(6)	026	○		
	G9(G8+13)	11.29	11.11	NRSM9012PB	2P	82	26	-	42	8.5	6.5	9	1(6)	026	○		
M14X2	G9	13.18	12.97	NRSM9014QP	4P	88	26	-	45	10.5	8	11	1(6)	026	○		
	G9	13.18	12.97	NRSM9014QB	2P	88	26	-	45	10.5	8	11	1(6)	026	○		
	G10	13.19	12.98	NRSM0014QP	4P	88	26	-	45	10.5	8	11	1(6)	026	○		
	G10	13.19	12.98	NRSM0014QB	2P	88	26	-	45	10.5	8	11	1(6)	026	○		
M16X2	G9	15.18	14.96	NRSM9016QP	4P	95	26	-	48	12.5	10	13	1(6)	026	○		
	G9	15.18	14.96	NRSM9016QB	2P	95	26	-	48	12.5	10	13	1(6)	026	○		
	G10	15.19	14.97	NRSM0016QP	4P	95	26	-	48	12.5	10	13	1(6)	026	○		
	G10	15.19	14.97	NRSM0016QB	2P	95	26	-	48	12.5	10	13	1(6)	026	○		
M20X2.5	G11	18.95	18.72	NRSM1020RP	4P	105	33	-	50	15	12	15	1(6)	026	○		
	G11	18.95	18.72	NRSM1020RB	2P	105	33	-	50	15	12	15	1(6)	026	○		

MF	TCTR (tolerance)	Bored Hole Ø (mm)		Code	THCHT (chamfer)	LF (mm)	THL (mm)	LU (mm)	LS (mm)	DCON (mm)	K (mm)	LK (mm)	NOF (Lobes)	Type	Stock	Intro
		Max	Min													
JIS																
M2X0.25	G4	1.91	1.89	NRSM42.0BP	4P	42	4.5	-	27	3	2.5	5	0(4)	010	○	
	G4	1.91	1.89	NRSM42.0BB	2P	42	4.5	-	27	3	2.5	5	0(4)	010	○	SP
	G5(G4+13)	1.93	1.9	NRSM52.0BP	4P	42	4.5	-	27	3	2.5	5	0(4)	010	○	
	G5(G4+13)	1.93	1.9	NRSM52.0BB	2P	42	4.5	-	27	3	2.5	5	0(4)	010	○	
M2.5X0.35	G4	2.35	2.33	NRSM42.5DP	4P	46	6.3	14	29	3	2.5	5	0(4)	012	○	
	G4	2.35	2.33	NRSM42.5DB	2P	46	6.3	14	29	3	2.5	5	0(4)	012	○	SL
	G5	2.37	2.36	NRSM52.5DP	4P	46	6.3	14	29	3	2.5	5	0(4)	012	○	
	G5	2.37	2.36	NRSM52.5DB	2P	46	6.3	14	29	3	2.5	5	0(4)	012	○	
M2.6X0.35	G5	2.42	2.4	NRSM52.6DP	4P	46	6.3	14	29	3	2.5	5	0(4)	012	○	
	G5	2.42	2.4	NRSM52.6DB	2P	46	6.3	14	29	3	2.5	5	0(4)	012	○	PO
	G6(G5+13)	2.44	2.41	NRSM62.6DP	4P	46	6.3	14	29	3	2.5	5	0(4)	012	○	
	G6(G5+13)	2.44	2.41	NRSM62.6DB	2P	46	6.3	14	29	3	2.5	5	0(4)	012	○	
M3X0.35	G5	2.86	2.79	NRSM53.0DP	4P	46	6.5	14	26	4	3.2	6	1(4)	012	○	
	G5	2.86	2.79	NRSM53.0DB	2P	46	6.5	14	26	4	3.2	6	1(4)	012	○	ST
	G6(G5+13)	2.87	2.8	NRSM63.0DP	4P	46	6.5	14	26	4	3.2	6	1(4)	012	○	
	G6(G5+13)	2.87	2.8	NRSM63.0DB	2P	46	6.5	14	26	4	3.2	6	1(4)	012	○	ROLL
M3.5X0.35	G5	3.25	3.22	NRSM53.5DP	4P	52	6.5	16	29	5	4	7	1(4)	012	○	JIS
	G5	3.25	3.22	NRSM53.5DB	2P	52	6.5	16	29	5	4	7	1(4)	012	○	
	G6(G5+13)	3.26	3.23	NRSM63.5DP	4P	52	6.5	16	29	5	4	7	1(4)	012	○	CARBIDE
	G6(G5+13)	3.26	3.23	NRSM63.5DB	2P	52	6.5	16	29	5	4	7	1(4)	012	○	
M4X0.5	G6	3.81	3.76	NRSM64.0GP	4P	52	9	17	29	5	4	7	1(4)	012	○	
	G6	3.81	3.76	NRSM64.0GB	2P	52	9	17	29	5	4	7	1(4)	012	○	
	G7(G6+13)	3.82	3.77	NRSM74.0GP	4P	52	9	17	29	5	4	7	1(4)	012	○	LONG
	G7(G6+13)	3.82	3.77	NRSM74.0GB	2P	52	9	17	29	5	4	7	1(4)	012	○	
M5X0.5	G6	4.81	4.76	NRSM65.0GP	4P	60	9	22	33	5.5	4.5	7	1(4)	012	○	
	G6	4.81	4.76	NRSM65.0GB	2P	60	9	22	33	5.5	4.5	7	1(4)	012	○	
	G7(G6+13)	4.82	4.77	NRSM75.0GP	4P	60	9	22	33	5.5	4.5	7	1(4)	012	○	HAND TAPS
	G7(G6+13)	4.82	4.77	NRSM75.0GB	2P	60	9	22	33	5.5	4.5	7	1(4)	012	○	
M6X0.75	G6	5.69	5.61	NRSM66.0JP	4P	62	15	26	33	6	4.5	7	1(4)	012	○	
	G6	5.69	5.61	NRSM66.0JB	2P	62	15	26	33	6	4.5	7	1(4)	012	○	
	G7(G6+13)	5.7	5.62	NRSM76.0JP	4P	62	15	26	33	6	4.5	7	1(4)	012	○	EG (STI)
	G7(G6+13)	5.7	5.62	NRSM76.0JB	2P	62	15	26	33	6	4.5	7	1(4)	012	○	
M6X0.5	G6	5.81	5.76	NRSM66.0GP	4P	62	9	26	33	6	4.5	7	1(4)	012	○	
	G6	5.81	5.76	NRSM66.0GB	2P	62	9	26	33	6	4.5	7	1(4)	012	○	SPECIAL THREADS, GAUGES
M7X0.75	G7	6.7	6.62	NRSM77.0JP	4P	70	19	-	36	6.2	5	8	1(4)	026	○	
	G7	6.7	6.62	NRSM77.0JB	2P	70	19	-	36	6.2	5	8	1(4)	026	○	
M8X1	G7	7.59	7.48	NRSM78.0MP	4P	70	19	-	36	6.2	5	8	1(6)	026	○	
	G7	7.59	7.48	NRSM78.0MB	2P	70	19	-	36	6.2	5	8	1(6)	026	○	THREAD MILLS
M8X0.75	G7	7.7	7.62	NRSM78.0JP	4P	70	19	-	36	6.2	5	8	1(6)	026	○	
	G7	7.7	7.62	NRSM78.0JB	2P	70	19	-	36	6.2	5	8	1(6)	026	○	
M10X1.25	G7	9.49	9.35	NRSM7010NP	4P	75	23	-	38	7	5.5	8	1(6)	026	○	
	G7	9.49	9.35	NRSM7010NB	2P	75	23	-	38	7	5.5	8	1(6)	026	○	DIES
	G8(G7+13)	9.5	9.37	NRSM8010NP	4P	75	23	-	38	7	5.5	8	1(6)	026	○	
	G8(G7+13)	9.5	9.37	NRSM8010NB	2P	75	23	-	38	7	5.5	8	1(6)	026	○	
M10X1	G7	9.59	9.48	NRSM7010MP	4P	75	23	-	38	7	5.5	8	1(6)	026	○	
	G7	9.59	9.48	NRSM7010MB	2P	75	23	-	38	7	5.5	8	1(6)	026	○	CENTER DRILLS

Forming Taps

Intro

MF	TCTR (tolerance)	Bored Hole Ø (mm)		Code	THCHT (chamfer)	LF (mm)	THL (mm)	LU (mm)	LS (mm)	DCON (mm)	K (mm)	LK (mm)	NOF (Lobes)	Type	Stock	
		Max	Min													
JIS																
SP	M12X1.5	G8	11.38	11.22	NRSM80120P	4P	82	26	-	42	8.5	6.5	9	1(6)	026	○
		G8	11.38	11.22	NRSM80120B	2P	82	26	-	42	8.5	6.5	9	1(6)	026	○
		G9(G8+13)	11.39	11.23	NRSM90120P	4P	82	26	-	42	8.5	6.5	9	1(6)	026	○
		G9(G8+13)	11.39	11.23	NRSM90120B	2P	82	26	-	42	8.5	6.5	9	1(6)	026	○
SL	M12X1.25	G8	11.49	11.35	NRSM8012NP	4P	82	26	-	42	8.5	6.5	9	1(6)	026	○
		G8	11.49	11.35	NRSM8012NB	2P	82	26	-	42	8.5	6.5	9	1(6)	026	○
		G9	11.5	11.36	NRSM9012NP	4P	82	26	-	42	8.5	6.5	9	1(6)	026	○
		G9	11.5	11.36	NRSM9012NB	2P	82	26	-	42	8.5	6.5	9	1(6)	026	○
PO	M12X1	G7	11.58	11.47	NRSM7012MP	4P	82	26	-	42	8.5	6.5	9	1(6)	026	○
		G7	11.58	11.47	NRSM7012MB	2P	82	26	-	42	8.5	6.5	9	1(6)	026	○
M14X1.5		G9	13.39	13.22	NRSM90140P	4P	88	26	-	45	10.5	8	11	1(6)	026	○
		G9	13.39	13.22	NRSM90140B	2P	88	26	-	45	10.5	8	11	1(6)	026	○
ST	M14X1	G8	13.59	13.48	NRSM8014MP	4P	88	26	-	45	10.5	8	11	1(6)	026	○
		G8	13.59	13.48	NRSM8014MB	2P	88	26	-	45	10.5	8	11	1(6)	026	○
ROLL	M16X1.5	G9	15.38	15.22	NRSM90160P	4P	95	26	-	48	12.5	10	13	1(6)	026	○
		G9	15.38	15.22	NRSM90160B	2P	95	26	-	48	12.5	10	13	1(6)	026	○
JIS	M16X1	G8	15.59	15.48	NRSM8016MP	4P	95	26	-	48	12.5	10	13	1(6)	026	○
		G8	15.59	15.48	NRSM8016MB	2P	95	26	-	48	12.5	10	13	1(6)	026	○
CARBIDE	M18X1.5	G9	17.38	17.22	NRSM90180P	4P	100	33	-	51	14	11	14	1(6)	026	○
		G9	17.38	17.22	NRSM90180B	2P	100	33	-	51	14	11	14	1(6)	026	○
LONG	M20X1.5	G9	19.37	19.21	NRSM90200P	4P	105	33	-	50	15	12	15	1(6)	026	○
		G9	19.37	19.21	NRSM90200B	2P	105	33	-	50	15	12	15	1(6)	026	○
		G10	19.39	19.22	NRSM00200P	4P	105	33	-	50	15	12	15	1(6)	026	○
		G10	19.39	19.22	NRSM00200B	2P	105	33	-	50	15	12	15	1(6)	026	○

HAND TAPS

UNC	TCTR (tolerance)	Bored Hole Ø (mm)		Code	THCHT (chamfer)	LF (mm)	THL (mm)	LU (mm)	LS (mm)	DCON (mm)	K (mm)	LK (mm)	NOF (Lobes)	Type	Stock	
		Max	Min													
JIS																
EG (STI)	No.2-56UNC	G4	2.01	1.96	NRSM4UN2EP	4P	42	8.1	-	27	3	2.5	5	0(4)	010	○
		G4	2.01	1.96	NRSM4UN2EB	2P	42	8.1	-	27	3	2.5	5	0(4)	010	○
		G5(G4+13)	2.02	1.97	NRSM5UN2EP	4P	42	8.1	-	27	3	2.5	5	0(4)	010	○
		G5(G4+13)	2.02	1.97	NRSM5UN2EB	2P	42	8.1	-	27	3	2.5	5	0(4)	010	○
		G7(G4+39)	2.04	2	NRSM7UN2EP	4P	42	8.1	-	27	3	2.5	5	0(4)	010	○
		G7(G4+39)	2.04	2	NRSM7UN2EB	2P	42	8.1	-	27	3	2.5	5	0(4)	010	○
		G6(G4+26)	2.03	1.98	NRSM6UN2EP	4P	42	8.1	-	27	3	2.5	5	0(4)	010	○
		G6(G4+26)	2.03	1.98	NRSM6UN2EB	2P	42	8.1	-	27	3	2.5	5	0(4)	010	○
THREAD MILLS	No.3-48UNC	G4	2.31	2.25	NRSM4UN3FP	4P	46	8.1	14	29	3	2.5	5	0(4)	012	○
		G4	2.31	2.25	NRSM4UN3FB	2P	46	8.1	14	29	3	2.5	5	0(4)	012	○
		G5(G4+13)	2.32	2.26	NRSM5UN3FP	4P	46	8.1	14	29	3	2.5	5	0(4)	012	○
		G5(G4+13)	2.32	2.26	NRSM5UN3FB	2P	46	8.1	14	29	3	2.5	5	0(4)	012	○
DIES	No.4-40UNC	G5	2.61	2.54	NRSM5UN4HP	4P	46	9	14	26	4	3.2	6	0(4)	012	○
		G5	2.61	2.54	NRSM5UN4HB	2P	46	9	14	26	4	3.2	6	0(4)	012	○
		G6(G5+13)	2.62	2.55	NRSM6UN4HP	4P	46	9	14	26	4	3.2	6	0(4)	012	○
		G6(G5+13)	2.62	2.55	NRSM6UN4HB	2P	46	9	14	26	4	3.2	6	0(4)	012	○
		G7(G5+26)	2.63	2.57	NRSM7UN4HP	4P	46	9	14	26	4	3.2	6	0(4)	012	○
CENTER DRILLS	No.5-40UNC	G7(G5+26)	2.63	2.57	NRSM7UN4HB	2P	46	9	14	26	4	3.2	6	0(4)	012	○
		G5	2.94	2.87	NRSM5UN5HP	4P	52	11	16	28	5	4	7	1(4)	012	○

Technical info

UNC	TCTR (tolerance)	Bored Hole Ø (mm)		Code	THCHT (chamfer)	LF (mm)	THL (mm)	LU (mm)	LS (mm)	DCON (mm)	K (mm)	LK (mm)	NOF (Lobes)	Type	Stock
		Max	Min												
JIS															
No.6-32UNC	G5	3.19	3.11	NRSM5UN6JP	4P	52	11	16	29	5	4	7	1(4)	012	○
	G5	3.19	3.11	NRSM5UN6JB	2P	52	11	16	29	5	4	7	1(4)	012	○
	G6(G5+13)	3.21	3.13	NRSM6UN6JP	4P	52	11	16	29	5	4	7	1(4)	012	○
	G6(G5+13)	3.21	3.13	NRSM6UN6JB	2P	52	11	16	29	5	4	7	1(4)	012	○
	G7(G5+26)	3.22	3.13	NRSM7UN6JP	4P	52	11	16	29	5	4	7	1(4)	012	○
	G7(G5+26)	3.22	3.13	NRSM7UN6JB	2P	52	11	16	29	5	4	7	1(4)	012	○
No.8-32UNC	G6	3.87	3.78	NRSM6UN8JP	4P	60	13	21	33	5.5	4.5	7	1(4)	012	○
	G6	3.87	3.78	NRSM6UN8JB	2P	60	13	21	33	5.5	4.5	7	1(4)	012	○
	G7(G6+13)	3.88	3.84	NRSM7UN8JP	4P	60	13	21	33	5.5	4.5	7	1(4)	012	○
	G7(G6+13)	3.88	3.84	NRSM7UN8JB	2P	60	13	21	33	5.5	4.5	7	1(4)	012	○
	G8(G6+26)	3.89	3.81	NRSM8UN8JP	4P	60	13	21	33	5.5	4.5	7	1(4)	012	○
No.10-24UNC	G6	4.41	4.3	NRSM6UNAMP	4P	60	13	22	33	5.5	4.5	7	1(4)	012	○
	G6	4.41	4.3	NRSM6UNAMB	2P	60	13	22	33	5.5	4.5	7	1(4)	012	○
	G7(G6+13)	4.42	4.31	NRSM7UNAMP	4P	60	13	22	33	5.5	4.5	7	1(4)	012	○
	G7(G6+13)	4.42	4.31	NRSM7UNAMB	2P	60	13	22	33	5.5	4.5	7	1(4)	012	○
1/4-20UNC	G6	5.85	5.71	NRSM6U04NP	4P	62	15	26	33	6	4.5	7	1(4)	012	○
	G6	5.85	5.71	NRSM6U04NB	2P	62	15	26	33	6	4.5	7	1(4)	012	○
	G7	5.86	5.73	NRSM7U04NP	4P	62	15	26	33	6	4.5	7	1(4)	012	○
	G7	5.86	5.73	NRSM7U04NB	2P	62	15	26	33	6	4.5	7	1(4)	012	○
	G8(G7+13)	5.88	5.74	NRSM8U04NP	4P	62	15	26	33	6	4.5	7	1(4)	012	○
	G8(G7+13)	5.88	5.74	NRSM8U04NB	2P	62	15	26	33	6	4.5	7	1(4)	012	○
UNF															
UNF	TCTR (tolerance)	Bored Hole Ø (mm)		Code	THCHT (chamfer)	LF (mm)	THL (mm)	LU (mm)	LS (mm)	DCON (mm)	K (mm)	LK (mm)	NOF (Lobes)	Type	Stock
		Max	Min												
JIS															
No.0-80UNF	G5	1.42	1.39	NRSM5UN0BP	4P	36	6.3	-	24	3	2.5	5	0(3)	010	○
	G5	1.42	1.39	NRSM5UN0BB	2P	36	6.3	-	24	3	2.5	5	0(3)	010	○
No.1-72UNF	G5	1.74	1.7	NRSM5UN1CP	4P	42	7.2	-	27	3	2.5	5	0(3)	010	○
	G5	1.74	1.7	NRSM5UN1CB	2P	42	7.2	-	27	3	2.5	5	0(3)	010	○
No.4-48UNF	G5	2.65	2.59	NRSM5UN4FP	4P	46	9	14	26	4	3.2	6	0(4)	012	○
	G5	2.65	2.59	NRSM5UN4FB	2P	46	9	14	26	4	3.2	6	0(4)	012	○
	G6(G5+13)	2.66	2.61	NRSM6UN4FP	4P	46	9	14	26	4	3.2	6	0(4)	012	○
	G6(G5+13)	2.66	2.61	NRSM6UN4FB	2P	46	9	14	26	4	3.2	6	0(4)	012	○
No.5-44UNF	G6	2.97	2.91	NRSM6UN5GB	2P	52	11	16	28	5	4	7	1(4)	012	○
No.6-40UNF	G5	3.26	3.19	NRSM5UN6HP	4P	52	11	16	29	5	4	7	1(4)	012	○
	G5	3.26	3.19	NRSM5UN6HB	2P	52	11	16	29	5	4	7	1(4)	012	○
No.8-36UNF	G5	3.89	3.81	NRSM5UN8IP	4P	60	13	21	33	5.5	4.5	7	1(4)	012	○
	G5	3.89	3.81	NRSM5UN8IB	2P	60	13	21	33	5.5	4.5	7	1(4)	012	○
	G6(G5+13)	3.9	3.82	NRSM6UN8IB	2P	60	13	21	33	5.5	4.5	7	1(4)	012	○
No.10-32UNF	G6	4.53	4.44	NRSM6UNAJP	4P	60	13	22	33	5.5	4.5	7	1(4)	012	○
	G6	4.53	4.44	NRSM6UNAJB	2P	60	13	22	33	5.5	4.5	7	1(4)	012	○
	G7(G6+13)	4.54	4.45	NRSM7UNAJP	4P	60	13	22	33	5.5	4.5	7	1(4)	012	○
	G7(G6+13)	4.54	4.45	NRSM7UNAJB	2P	60	13	22	33	5.5	4.5	7	1(4)	012	○
1/4-28UNF	G6	5.99	5.89	NRSM6U04KP	4P	62	15	26	33	6	4.5	7	1(4)	012	○
	G6	5.99	5.89	NRSM6U04KB	2P	62	15	26	33	6	4.5	7	1(4)	012	○
	G7	6	5.91	NRSM7U04KB	2P	62	15	26	33	6	4.5	7	1(4)	012	○

Intro

SP

SL

PO

ST

ROLL

JIS

CARBIDE

LONG

HAND
TAPS

EG (STI)

SPECIAL
THREADS,
GAUGESTHREAD
MILLS

DIES

CENTER
DRILLSTechnical
info

Intro **HP+RZ/HP-RZ**

MP Multi Purpose Series

High Performance Thread Forming Taps, Coated



FEATURES

Multi purpose forming taps for blind and through hole application on a wide range of materials.

Specific design, HSSP substrate and suitable coating for stable and long life even at medium-high speed.



Recommended Tapping Speeds Depending On Materials

ISO	Vc (m/min)	ISO	Vc (m/min)	ISO	Vc (m/min)
P1	15÷30 ★	M1	10÷25 ★	N1	10÷45 ☆
P2	15÷30 ★	M2	10÷25 ★	N2	10÷45 ☆
P3	15÷25 ★				
P4	15÷25 ★				
P7	10÷25 ★				

★ 1st choice ☆ suitable

ROLL

JIS

CARBIDE

LONG

HAND TAPS

EG (STI)

SPECIAL THREADS, GAUGES

THREAD MILLS

DIES

CENTER DRILLS

Technical info

TYPE: ROLL_010

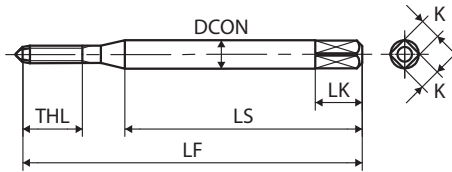

TYPE: ROLL_012

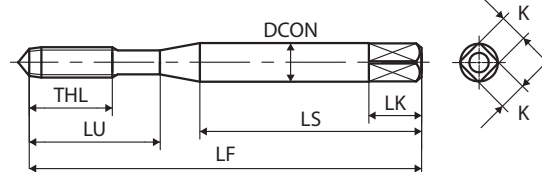

TYPE: ROLL_026

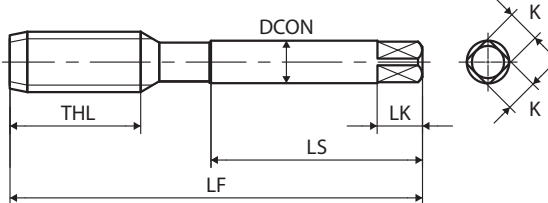

M	TCTR (tolerance)	Bored Hole Ø (mm)		Code	THCHT (chamfer)	LF (mm)	THL (mm)	LU (mm)	LS (mm)	DCON (mm)	K (mm)	LK (mm)	NOF (Lobes)	Type	Stock	Intro
		Max	Min													
JIS																
M1X0.25	G4	0.92	0.89	HRZP41.0BB	2P	36	4.5	-	24	3	2.5	5	0(4)	010	●	
M1.2X0.25	G4	1.11	1.09	HRZP41.2BB	2P	36	4.5	-	24	3	2.5	5	0(4)	010	●	SP
M1.4X0.3	G4	1.3	1.26	HRZP41.4CB	2P	36	5.4	-	24	3	2.5	5	0(4)	010	●	
M1.6X0.35	G4	1.46	1.43	HRZP41.6DB	2P	36	6.3	-	24	3	2.5	5	0(4)	010	●	
M1.7X0.35	G4	1.56	1.52	HRZP41.7DB	2P	36	6.3	-	24	3	2.5	5	0(4)	010	○	SL
M2X0.4	G4	1.83	1.79	HRZP42.0EB	2P	42	7.2	-	27	3	2.5	5	0(4)	010	○	
	G5(G4+13)	1.84	1.8	HRZP52.0EB	2P	42	7.2	-	27	3	2.5	5	0(4)	010	○	
M2.3X0.4	G4	2.13	2.09	HRZP42.3EB	2P	42	7.2	-	27	3	2.5	5	0(4)	010	○	
	G5(G4+13)	2.14	2.1	HRZP52.3EB	2P	42	7.2	-	27	3	2.5	5	0(4)	010	○	PO
M2.5X0.45	G5	2.32	2.27	HRZP52.5FB	2P	46	8.1	14	29	3	2.5	5	0(4)	012	○	
	G6(G5+13)	2.34	2.29	HRZP62.5FB	2P	46	8.1	14	29	3	2.5	5	0(4)	012	○	
M2.6X0.45	G5	2.42	2.37	HRZP52.6FB	2P	46	8.1	14	29	3	2.5	5	0(4)	012	○	
	G6(G5+13)	2.44	2.39	HRZP62.6FB	2P	46	8.1	14	29	3	2.5	5	0(4)	012	○	ST
M3X0.5	G5	2.8	2.75	HRZP53.0GP	4P	46	9	14	26	4	3.2	6	4(4)	012	○	
	G5	2.8	2.75	HRZP53.0GB	2P	46	9	14	26	4	3.2	6	4(4)	012	○	
	G6(G5+13)	2.82	2.76	HRZP63.0GP	4P	46	9	14	26	4	3.2	6	4(4)	012	○	ROLL
	G6(G5+13)	2.82	2.76	HRZP63.0GB	2P	46	9	14	26	4	3.2	6	4(4)	012	○	JIS
M3.5X0.6	G5	3.25	3.19	HRZP53.5HP	4P	52	11	16	29	5	4	7	4(4)	012	○	
	G5	3.25	3.19	HRZP53.5HB	2P	52	11	16	29	5	4	7	4(4)	012	○	
	G6(G5+13)	3.26	3.2	HRZP63.5HP	4P	52	11	16	29	5	4	7	4(4)	012	○	CARBIDE
	G6(G5+13)	3.26	3.2	HRZP63.5HB	2P	52	11	16	29	5	4	7	4(4)	012	○	
M4X0.7	G6	3.72	3.65	HRZP64.0IP	4P	52	11	17	29	5	4	7	4(4)	012	○	
	G6	3.72	3.65	HRZP64.0IB	2P	52	11	17	29	5	4	7	4(4)	012	○	
	G7(G6+13)	3.74	3.66	HRZP74.0IP	4P	52	11	17	29	5	4	7	4(4)	012	○	LONG
	G7(G6+13)	3.74	3.66	HRZP74.0IB	2P	52	11	17	29	5	4	7	4(4)	012	○	
M5X0.8	G6	4.67	4.59	HRZP65.0KP	4P	60	13	22	33	5.5	4.5	7	4(4)	012	○	
	G6	4.67	4.59	HRZP65.0KB	2P	60	13	22	33	5.5	4.5	7	4(4)	012	○	HAND TAPS
	G7(G6+13)	4.68	4.6	HRZP75.0KP	4P	60	13	22	33	5.5	4.5	7	4(4)	012	○	
	G7(G6+13)	4.68	4.6	HRZP75.0KB	2P	60	13	22	33	5.5	4.5	7	4(4)	012	○	
M6X1	G6	5.58	5.47	HRZP66.0MP	4P	62	15	26	33	6	4.5	7	4(4)	012	○	
	G6	5.58	5.47	HRZP66.0MB	2P	62	15	26	33	6	4.5	7	4(4)	012	○	EG (STI)
	G7(G6+13)	5.59	5.49	HRZP76.0MP	4P	62	15	26	33	6	4.5	7	4(4)	012	○	
	G7(G6+13)	5.59	5.49	HRZP76.0MB	2P	62	15	26	33	6	4.5	7	4(4)	012	○	
M8X1.25	G7	7.49	7.37	HRZM78.0NP	4P	70	19	-	36	6.2	5	8	3(6)	026	○	SPECIAL THREADS, GAUGES
	G7	7.49	7.37	HRZM78.0NB	2P	70	19	-	36	6.2	5	8	3(6)	026	○	
	G8(G7+13)	7.51	7.37	HRZM88.0NP	4P	70	19	-	36	6.2	5	8	3(6)	026	○	
	G8(G7+13)	7.51	7.37	HRZM88.0NB	2P	70	19	-	36	6.2	5	8	3(6)	026	○	
M10X1.5	G7	9.38	9.22	HRZM70100P	4P	75	23	-	38	7	5.5	8	4(8)	026	○	THREAD MILLS
	G7	9.38	9.22	HRZM70100B	2P	75	23	-	38	7	5.5	8	4(8)	026	○	
	G8(G7+13)	9.39	9.23	HRZM80100P	4P	75	23	-	38	7	5.5	8	4(8)	026	○	
	G8(G7+13)	9.39	9.23	HRZM80100B	2P	75	23	-	38	7	5.5	8	4(8)	026	○	
M12X1.75	G8	11.28	11.09	HRZM8012PP	4P	82	26	-	42	8.5	6.5	9	4(8)	026	○	DIES
	G8	11.28	11.09	HRZM8012PB	2P	82	26	-	42	8.5	6.5	9	4(8)	026	○	
	G9(G8+13)	11.29	11.11	HRZM9012PP	4P	82	26	-	42	8.5	6.5	9	4(8)	026	○	
	G9(G8+13)	11.29	11.11	HRZM9012PB	2P	82	26	-	42	8.5	6.5	9	4(8)	026	○	CENTER DRILLS

Forming Taps

Intro

SP

SL

PO

ST

ROLL

JIS

CARBIDE

LONG

HAND
TAPS

EG (STI)

SPECIAL
THREADS,
GAUGES

THREAD
MILLS

DIES

CENTER
DRILLS

Technical
info

	MF	TCTR (tolerance)	Bored Hole Ø (mm)		Code	THCHT (chamfer)	LF (mm)	THL (mm)	LU (mm)	LS (mm)	DCON (mm)	K (mm)	LK (mm)	NOF (Lobes)	Type	Stock
			Max	Min												
JIS																
SP	M10X1.25	G7	9.49	9.35	HRZM7010NP	4P	75	23	-	38	7	5.5	8	4(8)	026	○
		G7	9.49	9.35	HRZM7010NB	2P	75	23	-	38	7	5.5	8	4(8)	026	○
		G8(G7+13)	9.5	9.37	HRZM8010NP	4P	75	23	-	38	7	5.5	8	4(8)	026	○
		G8(G7+13)	9.5	9.37	HRZM8010NB	2P	75	23	-	38	7	5.5	8	4(8)	026	○
SL	M12X1.5	G8	11.38	11.22	HRZM80120P	4P	82	26	-	42	8.5	6.5	9	4(8)	026	○
		G8	11.38	11.22	HRZM80120B	2P	82	26	-	42	8.5	6.5	9	4(8)	026	○
		G9(G8+13)	11.39	11.23	HRZM90120P	4P	82	26	-	42	8.5	6.5	9	4(8)	026	○
		G9(G8+13)	11.39	11.23	HRZM90120B	2P	82	26	-	42	8.5	6.5	9	4(8)	026	○
PO	M12X1.25	G8	11.49	11.35	HRZM8012NP	4P	82	26	-	42	8.5	6.5	9	4(8)	026	○
		G8	11.49	11.35	HRZM8012NB	2P	82	26	-	42	8.5	6.5	9	4(8)	026	○
		G9	11.5	11.36	HRZM9012NP	4P	82	26	-	42	8.5	6.5	9	4(8)	026	○
		G9	11.5	11.36	HRZM9012NB	2P	82	26	-	42	8.5	6.5	9	4(8)	026	○
ST	M14X1.5	G9	13.39	13.22	HRZM90140P	4P	88	26	-	45	10.5	8	11	4(8)	026	○
		G9	13.39	13.22	HRZM90140B	2P	88	26	-	45	10.5	8	11	4(8)	026	○
ROLL	M16X1.5	G9	15.38	15.22	HRZM90160P	4P	95	26	-	48	12.5	10	13	4(8)	026	○
		G9	15.38	15.22	HRZM90160B	2P	95	26	-	48	12.5	10	13	4(8)	026	○
JIS	M18X1.5	G9	17.38	17.22	HRZM90180P	4P	100	33	-	51	14	11	14	4(8)	026	○
		G9	17.38	17.22	HRZM90180B	2P	100	33	-	51	14	11	14	4(8)	026	○
CARBIDE	M20X1.5	G9	19.37	19.21	HRZM90200P	4P	105	33	-	50	15	12	15	4(8)	026	○
		G9	19.37	19.21	HRZM90200B	2P	105	33	-	50	15	12	15	4(8)	026	○
JIS																
	UNC	TCTR (tolerance)	Bored Hole Ø (mm)		Code	THCHT (chamfer)	LF (mm)	THL (mm)	LU (mm)	LS (mm)	DCON (mm)	K (mm)	LK (mm)	NOF (Lobes)	Type	Stock
			Max	Min												
JIS																
LONG	No.2-56UNC	G4	2.01	1.96	HRZM4UN2EB	2P	42	8.1	-	27	3	2.5	5	0(3)	010	○
		G5(G4+13)	2.02	1.97	HRZM5UN2EB	2P	42	8.1	-	27	3	2.5	5	0(3)	010	○
HAND TAPS	No.3-48UNC	G4	2.31	2.25	HRZM4UN3FB	2P	46	8.1	14	29	3	2.5	5	0(4)	012	○
		G5	2.61	2.54	HRZM5UN4HB	2P	46	9	14	26	4	3.2	6	0(4)	012	○
EG (STI)	No.4-40UNC	G6(G5+13)	2.62	2.55	HRZM6UN4HB	2P	46	9	14	26	4	3.2	6	0(4)	012	○
		G5	2.94	2.87	HRZM5UN5HP	4P	52	11	16	29	5	4	7	2(4)	012	○
SPECIAL THREADS, GAUGES	No.5-40UNC	G5	2.94	2.87	HRZM5UN5HB	2P	52	11	16	29	5	4	7	2(4)	012	○
		G5	3.19	3.11	HRZM5UN6JP	4P	52	11	16	29	5	4	7	2(4)	012	○
THREAD MILLS	No.6-32UNC	G5	3.19	3.11	HRZM5UN6JB	2P	52	11	16	29	5	4	7	2(4)	012	○
		G6(G5+13)	3.21	3.13	HRZM6UN6JP	4P	52	11	16	29	5	4	7	2(4)	012	○
		G6(G5+13)	3.21	3.13	HRZM6UN6JB	2P	52	11	16	29	5	4	7	2(4)	012	○
		G6	3.87	3.78	HRZM6UN8JP	4P	60	13	21	33	5.5	4.5	7	2(4)	012	○
DIES	No.8-32UNC	G6	3.87	3.78	HRZM6UN8JB	2P	60	13	21	33	5.5	4.5	7	2(4)	012	○
		G7(G6+13)	3.88	3.84	HRZM7UN8JP	4P	60	13	21	33	5.5	4.5	7	2(4)	012	○
		G7(G6+13)	3.88	3.84	HRZM7UN8JB	2P	60	13	21	33	5.5	4.5	7	2(4)	012	○
		G6	4.41	4.3	HRZM6UNAMP	4P	60	13	22	33	5.5	4.5	7	2(4)	012	○
CENTER DRILLS	No.10-24UNC	G6	4.41	4.3	HRZM6UNAMB	2P	60	13	22	33	5.5	4.5	7	2(4)	012	○
		G7(G6+13)	4.42	4.31	HRZM7UNAMP	4P	60	13	22	33	5.5	4.5	7	2(4)	012	○
		G7(G6+13)	4.42	4.31	HRZM7UNAMB	2P	60	13	22	33	5.5	4.5	7	2(4)	012	○
		G6	5.07	4.96	HRZM6UNCMP	4P	62	15	26	33	6	4.5	7	2(4)	012	○
TECHNICAL INFO	1/4-20UNC	G6	5.07	4.96	HRZM6UNCMB	2P	62	15	26	33	6	4.5	7	2(4)	012	○
		G7	5.86	5.73	HRZM7U04NP	4P	62	15	26	33	6	4.5	7	2(4)	012	○
G7	5.86	5.73	HRZM7U04NB	2P	62	15	26	33	6	4.5	7	2(4)	012	○		

UNF	TCTR (tolerance)	Bored Hole Ø (mm)		Code	THCHT (chamfer)	LF (mm)	THL (mm)	LU (mm)	LS (mm)	DCON (mm)	K (mm)	LK (mm)	NOF (Lobes)	Type	Stock
		Max	Min												
JIS															
No.2-64UNF	G4	2.03	1.98	HRZM4UN2DB	2P	42	8.1	-	27	3	2.5	5	0(3)	010	○
No.3-56UNF	G4	2.34	2.29	HRZM4UN3EB	2P	46	8.1	14	29	3	2.5	5	0(4)	012	○
No.4-48UNF	G5	2.65	2.59	HRZM5UN4FB	2P	46	9	14	26	4	3.2	6	0(4)	012	○
No.5-44UNF	G5	2.96	2.9	HRZM5UN5GP	4P	52	11	16	29	5	4	7	2(4)	012	○
	G5	2.96	2.9	HRZM5UN5GB	2P	52	11	16	29	5	4	7	2(4)	012	○
No.6-40UNF	G5	3.26	3.19	HRZM5UN6HP	4P	52	11	16	29	5	4	7	2(4)	012	○
	G5	3.26	3.19	HRZM5UN6HB	2P	52	11	16	29	5	4	7	2(4)	012	○
No.8-36UNF	G6(G5+13)	3.9	3.82	HRZM6UN8IP	4P	60	13	21	33	5.5	4.5	7	2(4)	012	○
	G6(G5+13)	3.9	3.82	HRZM6UN8IB	2P	60	13	21	33	5.5	4.5	7	2(4)	012	○
No.10-32UNF	G6	4.53	4.44	HRZM6UNAJP	4P	60	13	22	33	5.5	4.5	7	2(4)	012	○
	G6	4.53	4.44	HRZM6UNAJB	2P	60	13	22	33	5.5	4.5	7	2(4)	012	○
	G7(G6+13)	4.54	4.45	HRZM7UNAJP	4P	60	13	22	33	5.5	4.5	7	2(4)	012	○
	G7(G6+13)	4.54	4.45	HRZM7UNAJB	2P	60	13	22	33	5.5	4.5	7	2(4)	012	○
No.12-28UNF	G6	5.13	5.03	HRZM6UNCKP	4P	62	15	26	33	6	4.5	7	2(4)	012	○
	G6	5.13	5.03	HRZM6UNCKB	2P	62	15	26	33	6	4.5	7	2(4)	012	○
1/4-28UNF	G7	6	5.91	HRZM7U04KP	4P	62	15	26	33	6	4.5	7	2(4)	012	○
	G7	6	5.91	HRZM7U04KB	2P	62	15	26	33	6	4.5	7	2(4)	012	○

Intro

SP

SL

PO

ST

ROLL

JIS

CARBIDE

LONG

HAND
TAPS

EG (STI)

SPECIAL
THREADS,
GAUGESTHREAD
MILLS

DIES

CENTER
DRILLSTechnical
info

Intro

SURZ

MP Multi Purpose Series

Thread Forming Taps for Stainless Steel, Coated



SP

SL

PO

ST

ROLL

JIS

CARBIDE

LONG

HAND
TAPS

EG (STI)

SPECIAL
THREADS,
GAUGESTHREAD
MILLS

DIES

CENTER
DRILLSTechnical
info

Recommended Tapping Speeds Depending On Materials

ISO	Vc (m/min)	★	ISO	Vc (m/min)	★
P1	15÷30	★	M1	10÷25	★
P2	15÷30	★	M2	10÷25	★
P3	15÷25	★			
P4	15÷25	★			
P7	10÷25	★			

★ 1st choice ☆ suitable

Product Features

- Adopting the special form on thread root, SURZ controls the minor diameter geometry of internal threads.
- Special lobe shape reduces the tapping torque.
- High efficiency can be obtained in thread forming of stainless steel parts.
- The minor diameter geometry of internal threads can be adjusted modifying the bored hole size.

Process Data

M2x0.4

Work-material	AISI 304 - 1.4301
Tapping length	5.2mm (Blind hole)
Tapping speed	5m/min
Bored hole	φ1.85 - φ1.82
Machine	Machining center (BT15)
Feed	Rigid
Tapping direction	Vertical
Lubricant	Water soluble oil (×20)

M2x0.4 6H internal thread minor diameter and tolerance	
Max.	1.679
Min.	1.567
Tolerance	0.112

Bored hole size	φ1.82	φ1.81
Cross section picture of internal threads		
Seam shape	Small seams	No seam
Minor diameter	φ1.59	φ1.58
Bored hole size	φ1.84	φ1.83
Cross section picture of internal threads		
Seam shape	Regular seams	Small seams
Minor diameter	φ1.62	φ1.60

FEATURES

Multi purpose forming taps for blind and through hole application.

Special form on thread root to control the minor diameter of internal threads.

Special lobe shape to reduce tapping torque.

Recommended bored hole diameter before tapping

Unit : mm

Size	Class	Recommended bored hole size
M1X0.25	G4	0.90
M1.2X0.25	G4	1.10
M1.4X0.3	G4	1.28
M1.6X0.2	G3	1.52
M1.6X0.35	G4	1.46
M1.7X0.35	G4	1.56
M2X0.4	G4	1.82
M2.3X0.4	G4	2.12
M2.5X0.45	G4	2.30
M2.6X0.45	G5	2.40
M3X0.5	G5	2.77
No.2-56UNC	G4	1.98
No.4-40UNC	G5	2.55
No.6-32UNC	G5	3.14

Based on our tapping test experiences the recommended bored hole diameters shown in above table have been calculated aiming at 90% thread engagement and trying to avoid tap breakage.

Recommended bore hole diameter may change because material deformation can slightly change depending on material, hardness, dimension of workpiece and tapping condition.

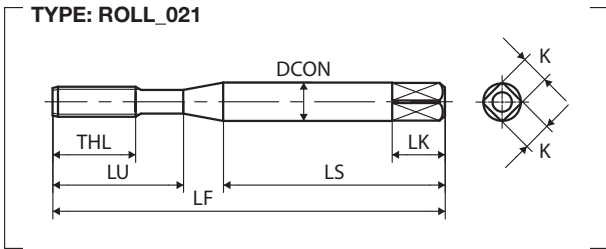
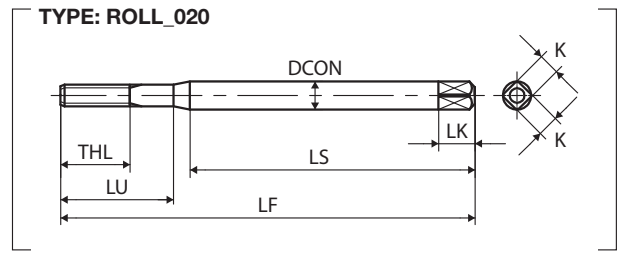
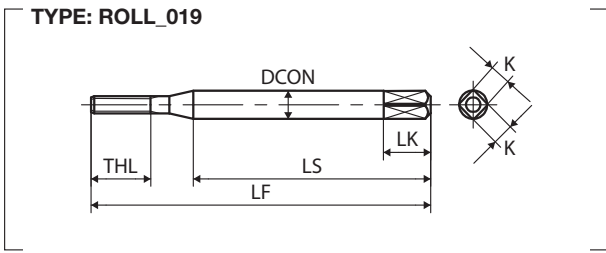

M	TCTR (tolerance)	Bored Hole Ø (mm)		Code	THCHT (chamfer)	LF (mm)	THL (mm)	LU (mm)	LS (mm)	DCON (mm)	K (mm)	LK (mm)	NOF (Lobes)	Type	Stock
		Max	Min												
JIS															
M1X0.25	G4	0.92	0.89	SURZ41.0BB	2P	36	4.5	-	24	3	2.5	5	0(4)	019	○
M1.2X0.25	G4	1.11	1.09	SURZ41.2BB	2P	36	4.5	-	24	3	2.5	5	0(4)	019	○
M1.4X0.3	G4	1.3	1.26	SURZ41.4CB	2P	36	5.4	-	24	3	2.5	5	0(4)	019	○
M1.6X0.35	G4	1.46	1.43	SURZ41.6DB	2P	36	6.3	-	24	3	2.5	5	0(4)	019	○
M1.7X0.35	G4	1.56	1.52	SURZ41.7DB	2P	36	6.3	-	24	3	2.5	5	0(4)	019	○
M2X0.4	G4	1.83	1.79	SURZ42.0EB	2P	42	7.2	-	27	3	2.5	5	0(4)	020	○
M2.3X0.4	G4	2.13	2.09	SURZ42.3EB	2P	42	7.2	-	27	3	2.5	5	0(4)	020	○
M2.5X0.45	G4	2.31	2.26	SURZ42.5FB	2P	46	8.1	14	29	3	2.5	5	0(4)	021	○
M2.6X0.45	G5	2.42	2.37	SURZ52.6FB	2P	46	8.1	14	29	3	2.5	5	0(4)	021	○
M3X0.5	G5	2.8	2.75	SURZ53.0GB	2P	46	9	14	26	4	3.2	6	2(4)	021	○
MF															
	TCTR (tolerance)	Bored Hole Ø (mm)		Code	THCHT (chamfer)	LF (mm)	THL (mm)	LU (mm)	LS (mm)	DCON (mm)	K (mm)	LK (mm)	NOF (Lobes)	Type	Stock
		Max	Min												
JIS															
M1.6X0.2	G3	1.53	1.5	SURZ31.6AB	2P	36	3.6	-	24	3	2.5	5	0(4)	019	○
UNC															
	TCTR (tolerance)	Bored Hole Ø (mm)		Code	THCHT (chamfer)	LF (mm)	THL (mm)	LU (mm)	LS (mm)	DCON (mm)	K (mm)	LK (mm)	NOF (Lobes)	Type	Stock
		Max	Min												
JIS															
No.2-56UNC	G4	2.01	1.96	SURZ4UN2EB	2P	42	8.1	-	27	3	2.5	5	0(3)	020	○
No.4-40UNC	G5	2.61	2.54	SURZ5UN4HB	2P	46	9	14	26	4	3.2	6	0(4)	021	○
No.6-32UNC	G5	3.19	3.11	SURZ5UN6JB	2P	52	11	16	29	5	4	7	2(4)	021	○

Intro
SP
SL
PO
ST

ROLL
JIS

CARBIDE

LONG

HAND
TAPS

EG (STI)

SPECIAL
THREADS,
GAUGES

THREAD
MILLS

DIES

CENTER
DRILLS

Technical
info

Intro

SC-TL-RZ

MP Multi Purpose Series

Torqueless Thread Forming Taps with short chamfer, Coated



SP

SL



PO

Recommended Tapping Speeds Depending On Materials

ISO	Vc (m/min)	ISO	Vc (m/min)	ISO	Vc (m/min)
P1	15÷30 ★	M1	10÷25 ★	N1	10÷45 ☆
P2	15÷30 ★	M2	10÷25 ★	N2	10÷45 ☆
P3	15÷25 ★				
P4	15÷25 ★				
P7	10÷25 ★				

★ 1st choice ☆ suitable

ST

ROLL

JIS

CARBIDE

Product Features

- SC-TL-RZ results in longer tool life while producing high quality internal threads with little burrs.
- Suitable for tapping hard-to-machine materials of lower ductility.
- Longer tool life under water soluble oil.
- Wider tapping application range up to higher speed tapping.

LONG

Applicable materials:

- Stainless steel: AISI303, 304, 316
- Alloy steel: 42CrMo4
- Carbon steel: C45-C50
- Aluminum alloy casting and die casting

HAND TAPS

Process Data

M3×0.5

Work-material	40CrMo4 - 1.7225 (32HRC)
Tapping depth	4.5 mm
Tapping speed	20 m/min
Bored hole	ø2.8
Machine	Tapping center
Lubricant	Water soluble oil (×10)

EG (STI)

SPECIAL THREADS, GAUGES



SC-TL-RZ after 7,000 holes shows less wear and damage than competitor.

THREAD MILLS

DIES

CENTER DRILLS

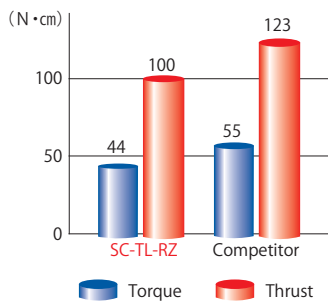

Technical info

FEATURES

Multi purpose forming taps for blind and through hole application on a wide range of materials.

Specific "torqueless" design to minimize the tapping torque.

1P extra short chamfer length.

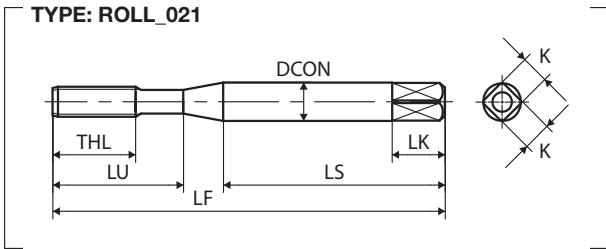
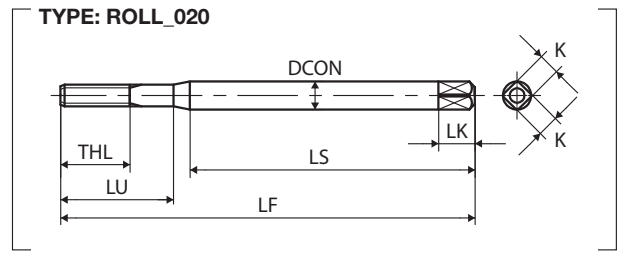
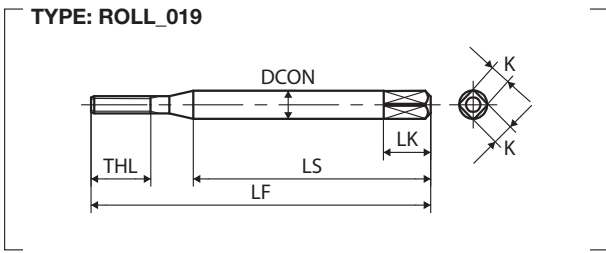

M	TCTR (tolerance)	Bored Hole Ø (mm)		Code	THCHT (chamfer)	LF (mm)	THL (mm)	LU (mm)	LS (mm)	DCON (mm)	K (mm)	LK (mm)	NOF (Lobes)	Type	Stock
		Max	Min												
JIS															
M1X0.25	G4	0.92	0.89	SRZM41.0B1	1P	36	4.5	-	24	3	2.5	5	0(4)	019	●
M1.2X0.25	G4	1.11	1.09	SRZM41.2B1	1P	36	4.5	-	24	3	2.5	5	0(4)	019	●
M1.4X0.3	G4	1.3	1.26	SRZM41.4C1	1P	36	5.4	-	24	3	2.5	5	0(4)	019	●
M1.6X0.35	G4	1.46	1.43	SRZM41.6D1	1P	36	6.3	-	24	3	2.5	5	0(4)	019	●
M1.7X0.35	G4	1.56	1.52	SRZM41.7D1	1P	36	6.3	-	24	3	2.5	5	0(4)	019	○
M2X0.4	G4	1.83	1.79	SRZM42.0E1	1P	42	7.2	-	27	3	2.5	5	0(4)	020	●
M2.5X0.45	G5	2.32	2.27	SRZM52.5F1	1P	46	8.1	14	29	3	2.5	5	0(4)	021	●
M2.6X0.45	G5	2.42	2.37	SRZM52.6F1	1P	46	8.1	14	29	3	2.5	5	0(4)	021	○
M3X0.5	G5	2.8	2.75	SRZM53.0G1	1P	46	9	14	26	4	3.2	6	2(4)	021	●
M4X0.7	G6	3.72	3.65	SRZM64.0I1	1P	52	11	17	29	5	4	7	2(4)	021	●
M5X0.8	G6	4.67	4.59	SRZM65.0K1	1P	60	13	22	33	5.5	4.5	7	2(4)	021	●
M6X1	G6	5.58	5.47	SRZM66.0M1	1P	62	15	26	33	6	4.5	7	2(4)	021	●
MF															
MF	TCTR (tolerance)	Bored Hole Ø (mm)		Code	THCHT (chamfer)	LF (mm)	THL (mm)	LU (mm)	LS (mm)	DCON (mm)	K (mm)	LK (mm)	NOF (Lobes)	Type	Stock
		Max	Min												
JIS															
M1.4X0.2	G3	1.33	1.3	SRZM31.4A1	1P	36	3.6	-	24	3	2.5	5	0(4)	019	○
M1.6X0.2	G3	1.53	1.5	SRZM31.6A1	1P	36	3.6	-	24	3	2.5	5	0(4)	019	○
UNC															
UNC	TCTR (tolerance)	Bored Hole Ø (mm)		Code	THCHT (chamfer)	LF (mm)	THL (mm)	LU (mm)	LS (mm)	DCON (mm)	K (mm)	LK (mm)	NOF (Lobes)	Type	Stock
		Max	Min												
JIS															
No.2-56UNC	G4	2.01	1.96	SRZM4UN2E1	1P	42	8.1	-	27	3	2.5	5	0(3)	020	○
No.4-40UNC	G5	2.61	2.54	SRZM5UN4H1	1P	46	9	14	25	4	3.2	6	0(4)	021	○

Intro
SP
SL
PO
ST

ROLL
JIS

CARBIDE

LONG

HAND
TAPS

EG (STI)

SPECIAL
THREADS,
GAUGES

THREAD
MILLS

DIES

CENTER
DRILLS

Technical
info

Intro

OL+RZ/OL-RZ

MP Multi Purpose Series

Thread Forming Taps for Dry Tapping, Coated



SP

SL

PO

ST

ROLL

JIS

CARBIDE

LONG

HAND TAPS

EG (STI)

SPECIAL THREADS, GAUGES

THREAD MILLS

DIES

CENTER DRILLS

Technical info

FEATURES

Dry Series forming taps for blind and through hole application.

Specific design, HSSP substrate and suitable coating for stable and long life even in difficult condition such as dry or MQL tapping.

For steel, stainless steel and non-ferrous materials.



Recommended Tapping Speeds Depending On Materials

ISO	Vc (m/min)	ISO	Vc (m/min)	ISO	Vc (m/min)
P1	15÷30 ★	M1	10÷25 ★	N1	10÷45 ☆
P2	15÷30 ★	M2	10÷25 ★	N2	10÷45 ☆
P3	15÷25 ★				
P4	15÷25 ★				
P7	10÷25 ★				

★ 1st choice ☆ suitable

TYPE: ROLL_010

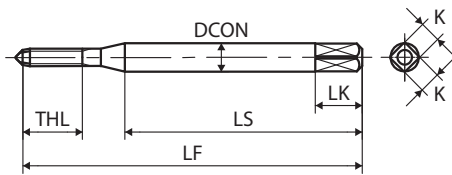

TYPE: ROLL_012

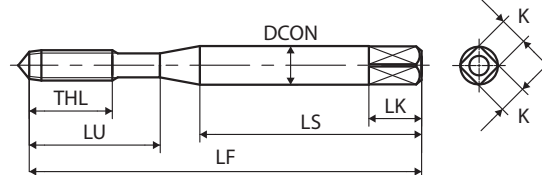

M	TCTR (tolerance)	Bored Hole Ø (mm)		Code	THCHT (chamfer)	LF (mm)	THL (mm)	LU (mm)	LS (mm)	DCON (mm)	K (mm)	LK (mm)	NOF (Lobes)	Type	Stock
		Max	Min												
JIS															
M1X0.25	G4	0.92	0.89	OLRZP41.0BP	4P	36	4.5	-	24	3	2.5	5	0(4)	010	○
M1.2X0.25	G4	1.11	1.09	OLRZP41.2BP	4P	36	4.5	-	24	3	2.5	5	0(4)	010	○
M1.4X0.3	G4	1.3	1.26	OLRZP41.4CP	4P	36	5.4	-	24	3	2.5	5	0(4)	010	○
M1.6X0.35	G4	1.46	1.43	OLRZP41.6DP	4P	36	6.3	-	24	3	2.5	5	0(4)	010	○
	G6(G4+26)	1.49	1.45	OLRZP61.6DP	4P	36	6.3	-	24	3	2.5	5	0(4)	010	○
M1.7X0.35	G4	1.56	1.52	OLRZP41.7DP	4P	36	6.3	-	24	3	2.5	5	0(4)	010	○
M2X0.4	G4	1.83	1.79	OLRZP42.0EP	4P	42	7.2	-	27	3	2.5	5	0(4)	010	○
	G5(G4+13)	1.84	1.8	OLRZP52.0EP	4P	42	7.2	-	27	3	2.5	5	0(4)	010	○
M2.3X0.4	G4	2.13	2.09	OLRZP42.3EP	4P	42	7.2	-	27	3	2.5	5	0(4)	010	○
	G5(G4+13)	2.14	2.1	OLRZP52.3EP	4P	42	7.2	-	27	3	2.5	5	0(4)	010	○
M2.5X0.45	G5	2.32	2.27	OLRZP52.5FP	4P	46	8.1	14	29	3	2.5	5	0(4)	012	○
	G6(G5+13)	2.34	2.29	OLRZP62.5FP	4P	46	8.1	14	29	3	2.5	5	0(4)	012	○
M2.6X0.45	G5	2.42	2.37	OLRZP52.6FP	4P	46	8.1	14	29	3	2.5	5	0(4)	012	○
	G6(G5+13)	2.44	2.39	OLRZP62.6FP	4P	46	8.1	14	29	3	2.5	5	0(4)	012	○
M3X0.5	G5	2.8	2.75	OLRZP53.0GP	4P	46	9	14	26	4	3.2	6	0(4)	012	○
	G6(G5+13)	2.82	2.76	OLRZP63.0GP	4P	46	9	14	26	4	3.2	6	0(4)	012	○

M	TCTR (tolerance)	Bored Hole Ø (mm)		Code	THCHT (chamfer)	LF (mm)	THL (mm)	LU (mm)	LS (mm)	DCON (mm)	K (mm)	LK (mm)	NOF (Lobes)	Type	Stock
		Max	Min												
JIS															
M3.5X0.6	G5	3.25	3.19	OLRZP53.5HP	4P	52	11	16	29	5	4	7	0(4)	012	○
	G6(G5+13)	3.26	3.2	OLRZP63.5HP	4P	52	11	16	29	5	4	7	0(4)	012	○
M4X0.7	G6	3.72	3.65	OLRZP64.0IP	4P	52	11	17	29	5	4	7	0(4)	012	○
	G7(G6+13)	3.74	3.66	OLRZP74.0IP	4P	52	11	17	29	5	4	7	0(4)	012	○
M5X0.8	G6	4.67	4.59	OLRZP65.0KP	4P	60	13	22	33	5.5	4.5	7	0(4)	012	○
	G7(G6+13)	4.68	4.6	OLRZP75.0KP	4P	60	13	22	33	5.5	4.5	7	0(4)	012	○
M6X1	G6	5.58	5.47	OLRZP66.0MP	4P	62	15	26	33	6	4.5	7	0(4)	012	○
	G7(G6+13)	5.59	5.49	OLRZP76.0MP	4P	62	15	26	33	6	4.5	7	0(4)	012	○

Intro

SP

SL

PO

ST

ROLL

JIS

CARBIDE

LONG

HAND
TAPS

EG (STI)

SPECIAL
THREADS,
GAUGESTHREAD
MILLS

DIES

CENTER
DRILLSTechnical
info

Intro **HP+RZ/HP-RZ**

MP Multi Purpose Series

High Performance Thread Forming Taps, Coated



FEATURES

Multi purpose forming taps for blind and through hole application on a wide range of materials.

Specific design, HSSP substrate and suitable coating for stable and long life even at medium-high speed.

Recommended Tapping Speeds Depending On Materials

ISO	Vc (m/min)	ISO	Vc (m/min)	ISO	Vc (m/min)
P1	15÷30 ★	M1	10÷25 ★	N1	10÷45 ☆
P2	15÷30 ★	M2	10÷25 ★	N2	10÷45 ☆
P3	15÷25 ★				
P4	15÷25 ★				
P7	10÷25 ★				

★ 1st choice ☆ suitable

ROLL

ANSI

CARBIDE

LONG

HAND TAPS

EG (STI)

SPECIAL THREADS, GAUGES

THREAD MILLS

DIES

CENTER DRILLS

Technical info

TYPE: US_004

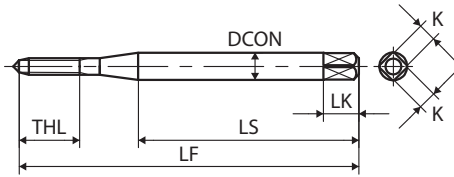

TYPE: US_005

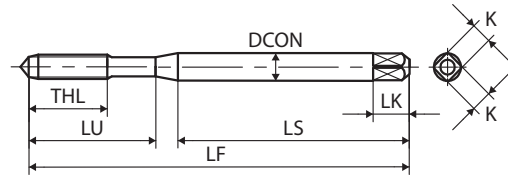

TYPE: US_006

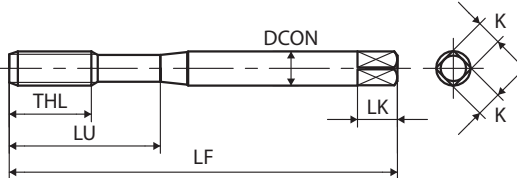

TYPE: US_007

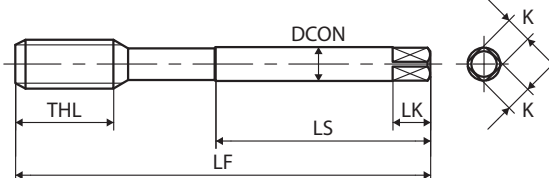

UNC	TCTR (tolerance)	Bored Hole Ø (mm)		Code	THCHT (chamfer)	LF (inch)	THL (inch)	LU (inch)	LS (inch)	DCON (inch)	K (inch)	LK (inch)	NOF (Lobes)	Type	Stock
		Max	Min												
ANSI															
No.2-56UNC	H3	1.99	1.97	386801M	2P	1.772	0.314	-	1.161	0.141	0.11	0.187	0(4)	004	○
No.3-48UNC	H3	2.3	2.27	386802M	2P	2.205	0.354	0.669	1.28	0.141	0.11	0.187	0(4)	005	○
No.4-40UNC	H3	2.58	2.55	386804M	2P	2.205	0.354	0.709	1.28	0.141	0.11	0.187	0(4)	005	○
	H5	2.61	2.57	386805M	2P	2.205	0.354	0.709	1.28	0.141	0.11	0.187	0(4)	005	○
No.5-40UNC	H5	2.94	2.9	386799M	2P	2.205	0.433	0.768	1.358	0.141	0.11	0.187	2(4)	005	○
No.6-32UNC	H3	3.17	3.13	386810M	4P	2.205	0.433	0.787	1.358	0.141	0.11	0.187	2(4)	005	○
	H3	3.17	3.13	386808M	2P	2.205	0.433	0.787	1.358	0.141	0.11	0.187	2(4)	005	○
	H5	3.19	3.15	386811M	4P	2.205	0.433	0.787	1.358	0.141	0.11	0.187	2(4)	005	○
	H5	3.19	3.15	386809M	2P	2.205	0.433	0.787	1.358	0.141	0.11	0.187	2(4)	005	●
No.8-32UNC	H3	3.83	3.79	386814M	4P	2.48	0.512	0.827	1.535	0.168	0.131	0.25	2(4)	005	○
	H3	3.83	3.79	386812M	2P	2.48	0.512	0.827	1.535	0.168	0.131	0.25	2(4)	005	○
	H5	3.85	3.81	386815M	4P	2.48	0.512	0.827	1.535	0.168	0.131	0.25	2(4)	005	○
	H5	3.85	3.81	386813M	2P	2.48	0.512	0.827	1.535	0.168	0.131	0.25	2(4)	005	●
No.10-24UNC	H4	4.99	4.33	386818M	4P	2.756	0.551	0.984	1.654	0.194	0.152	0.25	2(4)	005	○
	H4	4.99	4.33	386816M	2P	2.756	0.551	0.984	1.654	0.194	0.152	0.25	2(4)	005	○
	H6	4.41	4.35	386819M	4P	2.756	0.551	0.984	1.654	0.194	0.152	0.25	2(4)	005	○
	H6	4.41	4.35	386817M	2P	2.756	0.551	0.984	1.654	0.194	0.152	0.25	2(4)	005	●
1/4-20UNC	H4	5.83	5.76	386826M	4P	3.15	0.591	1.181	1.713	0.255	0.191	0.312	2(4)	005	○
	H4	5.83	5.76	386824M	2P	3.15	0.591	1.181	1.713	0.255	0.191	0.312	2(4)	005	○
	H6	5.85	5.78	386827M	4P	3.15	0.591	1.181	1.713	0.255	0.191	0.312	2(4)	005	○
	H6	5.85	5.78	386825M	2P	3.15	0.591	1.181	1.713	0.255	0.191	0.312	2(4)	005	●
5/16-18UNC	H5	7.36	7.28	386834M	4P	3.543	0.748	1.378	1.831	0.318	0.238	0.375	3(6)	006	○
	H5	7.36	7.28	386832M	2P	3.543	0.748	1.378	1.831	0.318	0.238	0.375	3(6)	006	○
	H7	7.38	7.31	386835M	4P	3.543	0.748	1.378	1.831	0.318	0.238	0.375	3(6)	006	○
	H7	7.38	7.31	386833M	2P	3.543	0.748	1.378	1.831	0.318	0.238	0.375	3(6)	006	●
3/8-16UNC	H5	8.86	8.78	386842M	4P	3.937	0.906	1.535	2.028	0.381	0.286	0.437	3(6)	006	○
	H5	8.86	8.78	386840M	2P	3.937	0.906	1.535	2.028	0.381	0.286	0.437	3(6)	006	○
	H7	8.89	8.8	386843M	4P	3.937	0.906	1.535	2.028	0.381	0.286	0.437	3(6)	006	○
	H7	8.89	8.8	386841M	2P	3.937	0.906	1.535	2.028	0.381	0.286	0.437	3(6)	006	●
7/16-14UNC	H5	10.35	10.26	386850M	4P	3.937	0.906	-	2.008	0.323	0.242	0.406	4(8)	007	○
	H5	10.35	10.26	386848M	2P	3.937	0.906	-	2.008	0.323	0.242	0.406	4(8)	007	○
	H7	10.38	10.28	386851M	4P	3.937	0.906	-	2.008	0.323	0.242	0.406	4(8)	007	○
	H7	10.38	10.28	386849M	2P	3.937	0.906	-	2.008	0.323	0.242	0.406	4(8)	007	○
1/2-13UNC	H5	11.88	11.77	386858M	4P	4.331	1.024	-	2.205	0.367	0.275	0.437	4(8)	007	○
	H5	11.88	11.77	386856M	2P	4.331	1.024	-	2.205	0.367	0.275	0.437	4(8)	007	○
	H7	11.9	11.8	386859M	4P	4.331	1.024	-	2.205	0.367	0.275	0.437	4(8)	007	○
	H7	11.9	11.8	386857M	2P	4.331	1.024	-	2.205	0.367	0.275	0.437	4(8)	007	○
ANSI															
UNF	TCTR (tolerance)	Bored Hole Ø (mm)		Code	THCHT (chamfer)	LF (inch)	THL (inch)	LU (inch)	LS (inch)	DCON (inch)	K (inch)	LK (inch)	NOF (Lobes)	Type	Stock
		Max	Min												
No.0-80UNF	H2	1.39	1.37	386800M	2P	1.772	0.236	-	1.161	0.141	0.11	0.187	0(3)	004	○
No.3-56UNF	H3	2.32	2.3	386803M	2P	2.205	0.354	0.669	1.28	0.141	0.11	0.187	0(4)	005	○
No.4-48UNF	H3	2.62	2.6	386806M	2P	2.205	0.354	0.709	1.28	0.141	0.11	0.187	0(4)	005	○
	H5	2.65	2.62	386807M	2P	2.205	0.354	0.709	1.28	0.141	0.11	0.187	0(4)	005	○

Intro

SP

SL

PO

ST

ROLL

ANSI

CARBIDE

LONG

HAND
TAPS

EG (STI)

SPECIAL
THREADS,
GAUGESTHREAD
MILLS

DIES

CENTER
DRILLSTechnical
info

Forming Taps

Intro

SP

SL

PO

ST

ROLL

ANSI

CARBIDE

LONG

HAND TAPS

EG (STI)

SPECIAL THREADS, GAUGES

THREAD MILLS

DIES

CENTER DRILLS

Technical info

UNF	TCTR (tolerance)	Bored Hole Ø (mm)		Code	THCHT (chamfer)	LF (inch)	THL (inch)	LU (inch)	LS (inch)	DCON (inch)	K (inch)	LK (inch)	NOF (Lobes)	Type	Stock
		Max	Min												
ANSI															
No.10-32UNF	H4	4.5	4.46	386822M	4P	2.756	0.551	0.984	1.654	0.194	0.152	0.25	2(4)	005	○
	H4	4.5	4.46	386820M	2P	2.756	0.551	0.984	1.654	0.194	0.152	0.25	2(4)	005	●
	H6	4.53	4.48	386823M	4P	2.756	0.551	0.984	1.654	0.194	0.152	0.25	2(4)	005	○
	H6	4.53	4.48	386821M	2P	2.756	0.551	0.984	1.654	0.194	0.152	0.25	2(4)	005	○
1/4-28UNF	H4	5.96	5.92	386830M	4P	3.15	0.591	1.181	1.713	0.255	0.191	0.312	2(4)	005	○
	H4	5.96	5.92	386828M	2P	3.15	0.591	1.181	1.713	0.255	0.191	0.312	2(4)	005	○
	H6	5.99	5.94	386831M	4P	3.15	0.591	1.181	1.713	0.255	0.191	0.312	2(4)	005	○
	H6	5.99	5.94	386829M	2P	3.15	0.591	1.181	1.713	0.255	0.191	0.312	2(4)	005	●
5/16-24UNF	H5	7.5	7.45	386838M	4P	3.543	0.748	1.378	1.831	0.318	0.238	0.375	3(6)	006	○
	H5	7.5	7.45	386836M	2P	3.543	0.748	1.378	1.831	0.318	0.238	0.375	3(6)	006	○
	H7	7.53	7.47	386839M	4P	3.543	0.748	1.378	1.831	0.318	0.238	0.375	3(6)	006	○
	H7	7.53	7.47	386837M	2P	3.543	0.748	1.378	1.831	0.318	0.238	0.375	3(6)	006	●
3/8-24UNF	H5	9.08	9.02	386846M	4P	3.937	0.906	1.535	2.028	0.381	0.286	0.437	3(6)	006	○
	H5	9.08	9.02	386844M	2P	3.937	0.906	1.535	2.028	0.381	0.286	0.437	3(6)	006	○
	H7	9.1	9.04	386847M	4P	3.937	0.906	1.535	2.028	0.381	0.286	0.437	3(6)	006	○
	H7	9.1	9.04	386845M	2P	3.937	0.906	1.535	2.028	0.381	0.286	0.437	3(6)	006	●
7/16-20UNF	H5	10.58	10.51	386854M	4P	3.937	0.906	-	2.008	0.323	0.242	0.406	4(8)	007	○
	H5	10.58	10.51	386852M	2P	3.937	0.906	-	2.008	0.323	0.242	0.406	4(8)	007	○
	H7	10.6	10.54	386855M	4P	3.937	0.906	-	2.008	0.323	0.242	0.406	4(8)	007	○
	H7	10.6	10.54	386853M	2P	3.937	0.906	-	2.008	0.323	0.242	0.406	4(8)	007	○
1/2-20UNF	H5	12.16	12.1	386862M	4P	4.331	1.024	-	2.205	0.367	0.275	0.437	4(8)	007	○
	H5	12.16	12.1	386860M	2P	4.331	1.024	-	2.205	0.367	0.275	0.437	4(8)	007	○
	H7	12.19	12.12	386863M	4P	4.331	1.024	-	2.205	0.367	0.275	0.437	4(8)	007	○
	H7	12.19	12.12	386861M	2P	4.331	1.024	-	2.205	0.367	0.275	0.437	4(8)	007	○

CARBIDE TAPS



CARBIDE - DIN **394**
CARBIDE - JIS **402**

Selection Chart

Intro

SP

SL

PO

ST

ROLL

CARBIDE

LONG

HAND TAPS

EG (STI)

SPECIAL THREADS, GAUGES











THREAD MILLS

DIES





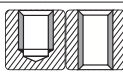
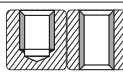
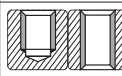
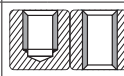

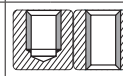
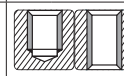







CENTER DRILLS

Technical info

MS Material Specific

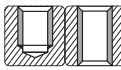
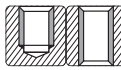
	CT FC	N-CT FC	CT-PF	LS-N-CT	N-CT-SP	N-CT-PO	CT LA	N-CT LA
	HF CARBIDE	HF CARBIDE	HF CARBIDE	HF CARBIDE	HF CARBIDE	HF CARBIDE	HF CARBIDE	HF CARBIDE
								
								
	DIN	JIS	JIS	JIS	JIS	JIS	DIN	JIS
M	395	403		408	411	413	397	415
MF		404		409	411			416
UNC/UNF		405						
UNS, 8, 12, 20, 32UN								
UNEF								
G (BSP)	395		407					
Rp (BSPP)								
Rc (BSPT)								
NPT								
NPTF								
NPSC, NPSM, NPSF								
BSW								
EG(STI), M, MF, UNC/UNF								
Pg								
Tr								
S miniature								
Special threads								
	Vc (m/min)							
P1								
P2								
P3								
P4								
P5								
P6								
P7								
P8								
M1								
M2								
M3								
K1	★ 5÷15	★ 5÷15	★ 5÷15	★ 5÷15				
K2	★ 5÷15	★ 5÷15	★ 5÷15	★ 5÷15				
K3	☆ ≤10	☆ ≤10	☆ ≤10	☆ ≤10				
K4	☆ ≤8	☆ ≤8	☆ ≤8	☆ ≤8				
N1					★ 10÷20	★ 10÷20	★ 10÷20	★ 10÷20
N2	★ 5÷15	★ 5÷15	★ 5÷10	★ 5÷15	★ 10÷20	★ 10÷20	★ 10÷20	★ 10÷20
N3								
N4	★ 5÷15	★ 5÷15	★ 5÷10	★ 5÷15	★ 10÷20	★ 10÷20	★ 10÷20	★ 10÷20
N5								
S1 (<25 HRC)								
S2 (<35 HRC)								
S3 (35 ÷ 45 HRC)								
S5								
H (45 ÷ 55 HRC)								
H (55 ÷ 63 HRC)								

★ 1st choice ☆ suitable

MS Material Specific				HS High Speed													
MC-AD-CT		ACHSP		EH-CT		UH-CT		HFICT-B		HFICT-P		HFACT-B		HFACT-P			
HF CARBIDE	COATING	HF CARBIDE	COATING	HF CARBIDE	COATING	HF CARBIDE	COATING	HF CARBIDE	COATING	HF CARBIDE	COATING	HF CARBIDE	COATING	HF CARBIDE	COATING		
																	
JIS	JIS	DIN	DIN	JIS	JIS	JIS	JIS										
419	421	399	401	422	423	424	425	M									
419	421			422	423	424	425	MF									
								UNC/UNF									
								UNS, 8UN, 12UN									
								UNEF									
								G (BSP)									
								Rp (BSPP)									
								Rc (BSPT)									
								NPT									
								NPTF									
								NPSC, NPSM, NPSF									
								BSW									
								EG(STI), M, MF, UNC/UNF									
								Pg									
								Tr									
								S miniature									
								Special threads									
Vc (m/min)																	
																	P1
																	P2
																	P3
																	P4
																	P5
																	P6
																	P7
																	P8
																	M1
																	M2
																	M3
								★ 25÷50	★ 25÷50								K1
								★ 25÷50	★ 25÷50								K2
																	K3
																	K4
★ 30÷60												★ 30÷100	★ 30÷100				N1
★ 30÷60	★ 30÷50											★ 30÷100	★ 30÷100				N2
																	N3
★ 30÷60												★ 30÷100	★ 30÷100				N4
																	N5
																	S1 (<35 HRC)
																	S2 (<35 HRC)
																	S3 (35 ÷ 45 HRC)
																	S5
		★ ≤5	★ ≤5														H (45 ÷ 55 HRC)
			★ ≤5														H (55 ÷ 63 HRC)

Intro

SP

SL

PO

ST

ROLL

CARBIDE

LONG

HAND TAPS

EG (STI)

SPECIAL THREADS, GAUGES

THREAD MILLS

DIES

CENTER DRILLS

Technical info

Intro

CT FC

MS Material Specific Series

Carbide Taps for Cast Iron

SP

SL



PO

Recommended Tapping Speeds Depending On Materials

ISO	Vc (m/min)	ISO	Vc (m/min)
K1	5÷15 ★	N2	5÷15 ★
K2	5÷15 ★	N4	5÷15 ★
K3	≤10 ☆		
K4	≤8 ☆		

★ 1st choice ☆ suitable

ST

ROLL

CARBIDE

DIN

LONG

HAND TAPS

EG (STI)

SPECIAL THREADS, GAUGES

THREAD MILLS

DIES

CENTER DRILLS

Technical info



FEATURES

Carbide for blind and through hole application.
Specific design for Cast Iron and Brass application.

TYPE: EU_040

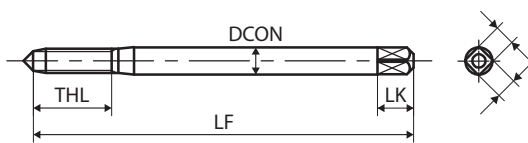

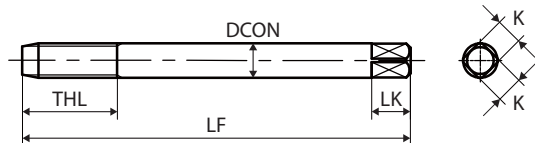

TYPE: EU_043

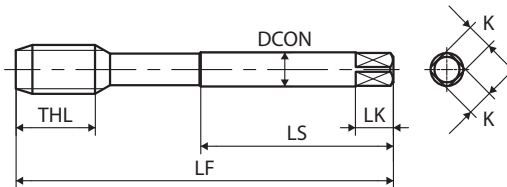

TYPE: EU_116



M	TCTR (tolerance)	 Hole Ø (mm)	Hole Ø (mm)	Code	THCHT (chamfer)	LF (mm)	THL (mm)	LU (mm)	LS (mm)	DCON (mm)	K (mm)	LK (mm)	NOF	Type	Stock
DIN 371															
M3X0.5	ISO2X(6HX)	2.5	2.56	36263.0	2.5P	56	11	-	-	3.5	2.7	6	3	040	○
M4X0.7	ISO2X(6HX)	3.3	3.38	36264.0	2.5P	63	13	-	-	4.5	3.4	6	4	040	●
M5X0.8	ISO2X(6HX)	4.2	4.28	36265.0	2.5P	70	16	-	-	6	4.9	8	4	040	●
M6X1	ISO2X(6HX)	5	5.09	36266.0	2.5P	80	19	-	-	6	4.9	8	4	040	○
M8X1.25	ISO2X(6HX)	6.8	6.85	36268.0	2.5P	90	22	-	-	8	6.2	9	4	043	○
M10X1.5	ISO2X(6HX)	8.5	8.6	3626010	2.5P	100	24	-	-	10	8	11	4	043	○
M	TCTR (tolerance)	 Hole Ø (mm)	Hole Ø (mm)	Code	THCHT (chamfer)	LF (mm)	THL (mm)	LU (mm)	LS (mm)	DCON (mm)	K (mm)	LK (mm)	NOF	Type	Stock
DIN 376															
M12X1.75	ISO2X(6HX)	10.3	10.36	3726012	2.5P	110	29	-	-	9	7	10	4	116	○
M14X2	ISO2X(6HX)	12	12.12	3726014	2.5P	110	30	-	-	11	9	12	4	116	●
M16X2	ISO2X(6HX)	14	14.12	3726016	2.5P	110	32	-	-	12	9	12	4	116	●
G(BSP)	TCTR (tolerance)	 Hole Ø (mm)	Hole Ø (mm)	Code	THCHT (chamfer)	Basic major Ø (mm)	LF (mm)	THL (mm)	LS (mm)	DCON (mm)	K (mm)	LK (mm)	NOF	Type	Stock
DIN 5156															
3/8-19	-	15.25	15.28	3926G06	2.5P	16.662	100	22	-	12	9	12	4	116	○

Intro

SP

SL

PO

ST

ROLL

CARBIDE

DIN

LONG

HAND
TAPS

EG (STI)

SPECIAL
THREADS,
GAUGESTHREAD
MILLS

DIES

CENTER
DRILLSTechnical
info

Intro

CT LA

MS Material Specific Series

Carbide Taps for Light Alloys



SP

SL



PO

Recommended Tapping Speeds Depending On Materials

ISO	Vc (m/min)
N1	10÷20 ★
N2	10÷20 ★
N4	10÷20 ★

★ 1st choice ☆ suitable

ST

ROLL

CARBIDE

DIN

LONG

HAND TAPS

EG (STI)

SPECIAL THREADS, GAUGES

THREAD MILLS

DIES

CENTER DRILLS

Technical info

FEATURES

Carbide for blind and through hole application.

Specific design for Aluminium casting, Aluminium die-casting and other non-ferrous materials.

TYPE: EU_040

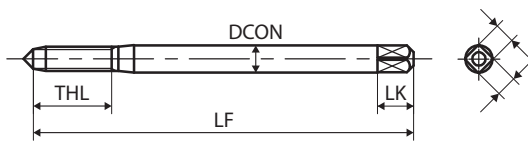

TYPE: EU_043

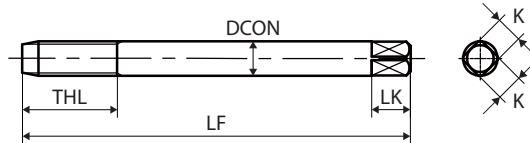

TYPE: EU_116

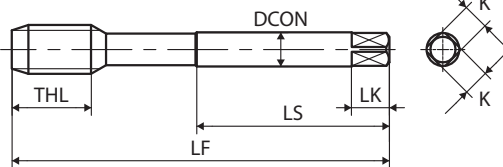

M	TCTR (tolerance)	 Hole Ø (mm)	Hole Ø (mm)	Code	THCHT (chamfer)	LF (mm)	THL (mm)	LU (mm)	LS (mm)	DCON (mm)	K (mm)	LK (mm)	NOF	Type	Stock
DIN 371															
M3X0.5	ISO2X(6HX)	2.5	2.56	TD3.0GBLWB3	3P	56	11	-	-	3.5	2.7	6	3	040	●
M4X0.7	ISO2X(6HX)	3.3	3.38	TD4.0IBLWB3	3P	63	13	-	-	4.5	3.4	6	3	040	●
M5X0.8	ISO2X(6HX)	4.2	4.28	TD5.0KBLWB3	3P	70	16	-	-	6	4.9	8	3	040	●
M6X1	ISO2X(6HX)	5	5.09	TD6.0MBLWB3	3P	80	19	-	-	6	4.9	8	3	040	●
M8X1.25	ISO2X(6HX)	6.8	6.85	TD8.0KBLWB3	3P	90	22	-	-	8	6.2	9	3	043	●
M10X1.5	ISO2X(6HX)	8.5	8.6	TD0100BLWB3	3P	100	24	-	-	10	8	11	3	043	●
M12X1.75	ISO2X(6HX)	10.3	10.36	TG012PBLWB3	3P	110	29	-	-	9	7	10	3	116	●

Intro

SP

SL

PO

ST

ROLL

CARBIDE

DIN

LONG

HAND
TAPS

EG (STI)

SPECIAL
THREADS,
GAUGESTHREAD
MILLS

DIES

CENTER
DRILLSTechnical
info

Intro

EH-CT

MS Material Specific Series

Carbide Taps for Hard Materials (<55HRC), Coated



SP

SL

PO

ST

ROLL

CARBIDE

DIN

LONG

HAND TAPS

EG (STI)

SPECIAL THREADS, GAUGES

THREAD MILLS

DIES

CENTER DRILLS

Technical info



FEATURES

Carbide taps for high hardness steel (45 ± 55HRC).

Specific design, ultra fine micrograin, suitable coating for long and stable tool life.

Recommended Tapping Speeds Depending On Materials

ISO Vc (m/min)

H1 ≤5 ★

★ 1st choice ☆ suitable

This item will be gradually replaced by:

· UH-CT page 400

Process Data

Work-material	X40CrMoV5 1 - 1.2344
Hardness	50HRC
Size	M8x1.25
Tapping speed	6 m/min
Feed system	Full rigid
Lubricant	non-soluble oil

Work-material	X20Cr13 - 1.4021
Hardness	52HRC
Size	M8x1.25
Tapping speed	6 m/min
Feed system	Full rigid
Lubricant	non-soluble oil

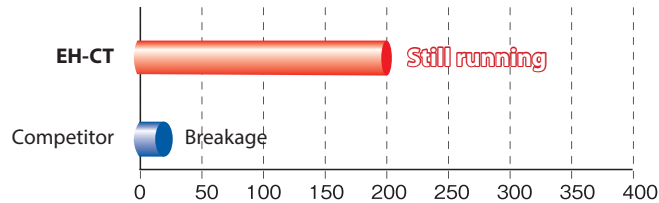
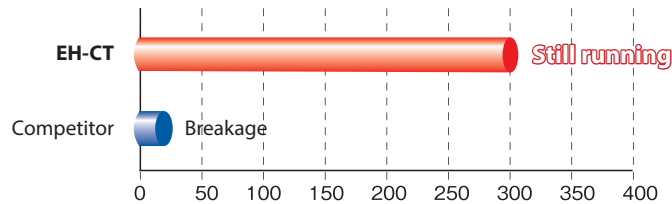

Torque line in different bored hole sizes

Bored hole size		6.8mm (Actual 6.79mm)	6.9mm (Actual 6.89mm)
Thread engagement ratio		89%	81%
Torque and thrust lines	Beginning		
		torque (average) 770N-cm	torque (average) 680N-cm
	After 50 holes tapping		
		torque (average) 890N-cm	torque (average) 780N-cm

EH-CT

Size: M8 x 1.25

Material: X40CrMoV5 1 - 1.2344

50 HRC

cutting speed: 6m/min

feed: rigid

Lubricant: non-soluble oil

Enlarging bored hole size by 0.1mm can reduce the tapping torque by 10%. When tapping materials of high hardness, it is recommendable to drill the bored hole size as large as possible.

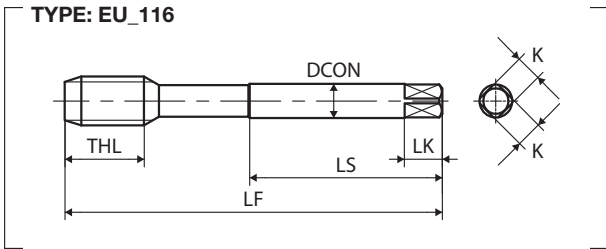
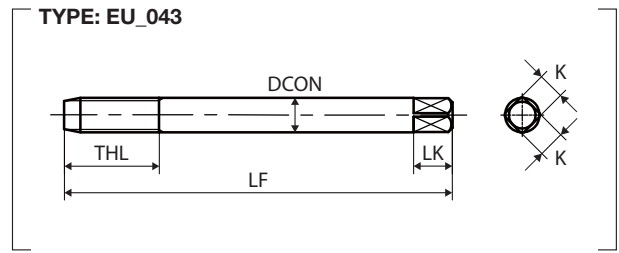
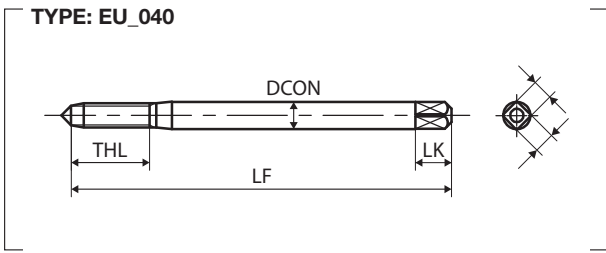

M	TCTR (tolerance)	\varnothing (mm)	Hole \varnothing (mm)	Code	THCHT (chamfer)	LF (mm)	THL (mm)	LU (mm)	LS (mm)	DCON (mm)	K (mm)	LK (mm)	NOF	Type	Stock
DIN 371															
M3X0.5	IS02X(6HX)	2.5	2.56	TD3.0GBCWA5	5P	56	11	-	-	3.5	2.7	6	4	040	▽
M4X0.7	IS02X(6HX)	3.3	3.38	TD4.0IBCWA5	5P	63	13	-	-	4.5	3.4	6	4	040	▽
M5X0.8	IS02X(6HX)	4.2	4.28	TD5.0KBCWA5	5P	70	16	-	-	6	4.9	8	4	040	▽
M6X1	IS02X(6HX)	5	5.09	TD6.0MBCWA5	5P	80	19	-	-	6	4.9	8	5	040	▽
M8X1.25	IS02X(6HX)	6.8	6.85	TD8.0NBCWA5	5P	90	22	-	-	8	6.2	9	5	043	▽
M10X1.5	IS02X(6HX)	8.5	8.6	TD0100BCWA5	5P	100	24	-	-	10	8	11	5	043	▽
DIN 376															
M12X1.75	IS02X(6HX)	10.3	10.36	TG012PBCWA5	5P	110	29	-	-	9	7	10	5	116	▽

- Intro
- SP
- SL
- PO
- ST
- ROLL
- CARBIDE**
- DIN**
- LONG
- HAND TAPS
- EG (STI)
- SPECIAL THREADS, GAUGES
- THREAD MILLS
- DIES
- CENTER DRILLS
- Technical info

Intro

UH-CT

MS Material Specific Series

Carbide Taps for Ultra Hard Materials (<63HRC), Coated



SP

SL



PO

Recommended Tapping Speeds Depending On Materials

ISO	Vc (m/min)
H1	≤5 ★
H2	≤5 ★

ST

★ 1st choice ☆ suitable

ROLL

CARBIDE

DIN

LONG

HAND TAPS

Process Data

Work-material	tool steel, heat-treated (60HRC)
Hardness	50HRC
Size	M8x1.25
Tapping length	16mm, through hole
Machine	CNC rigid tapping machine
Tapping speed	1.5m/min (60rpm)
Lubricant	non-soluble oil

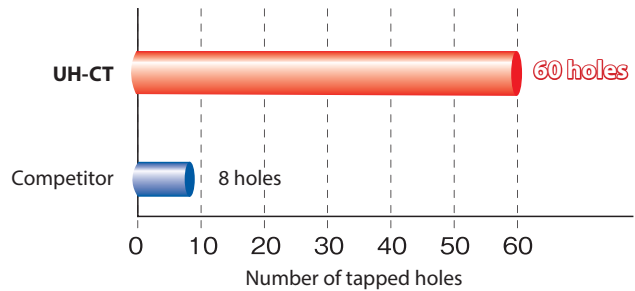

The graph above shows comparison data in tapping heat-treated tool steel by conventional carbide tap and UH-CT. Chipping occurred after 8th threads with conventional carbide tap. UH-CT can work efficiently even after 60 threads.

EG (STI)

The graph on the right shows the relation between the number of tapped holes and the load meter data of the machine on the tapping test up to 60 holes with UH-CT tap.

SPECIAL THREADS, GAUGES

Percentage of load meter figure tends to increase after tapping 50 holes. This is due to the damage on the tool's cutting edge. Then, tap breakage will happen if the load meter figure increases more and more. Thus for safety purposes, it is better to limit the number of tapping holes (tool life) when tapping high hardness steel materials.

THREAD MILLS

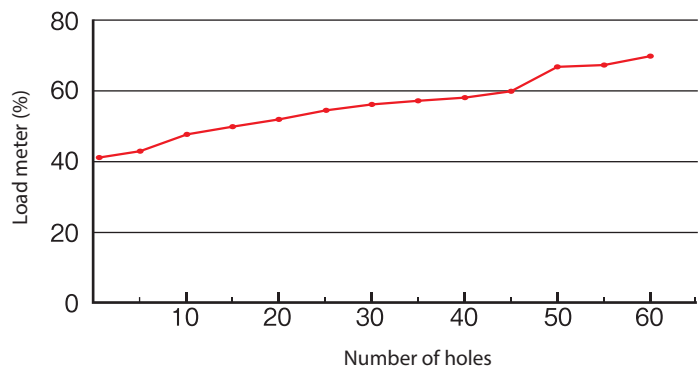

DIES

CENTER DRILLS

Technical info

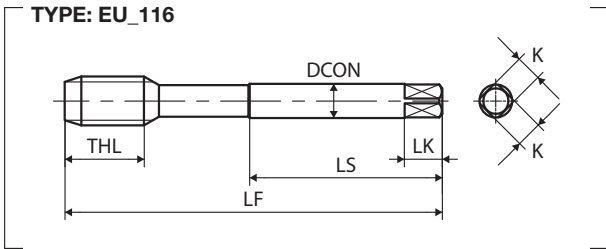
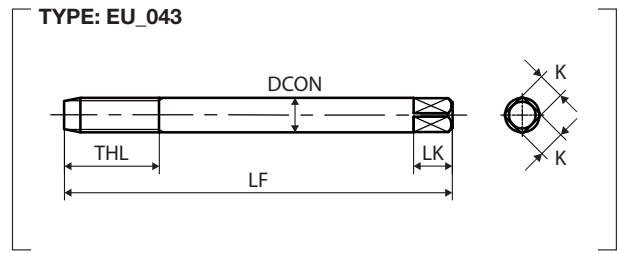
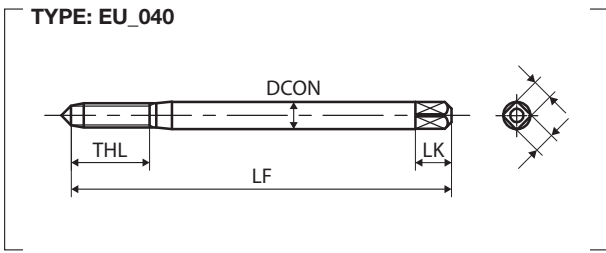

M	TCTR (tolerance)	\varnothing (mm)	Hole \varnothing (mm)	Code	THCHT (chamfer)	LF (mm)	THL (mm)	LU (mm)	LS (mm)	DCON (mm)	K (mm)	LK (mm)	NOF	Type	Stock
DIN 371															
M3X0.5	IS02X(6HX)	2.5	2.56	TD3.0GBBWA5	5P	56	11	-	-	3.5	2.7	6	4	040	●
M4X0.7	IS02X(6HX)	3.3	3.38	TD4.0IBBWA5	5P	63	13	-	-	4.5	3.4	6	4	040	●
M5X0.8	IS02X(6HX)	4.2	4.28	TD5.0KBBWA5	5P	70	16	-	-	6	4.9	8	4	040	●
M6X1	IS02X(6HX)	5	5.09	TD6.0MBBWA5	5P	80	19	-	-	6	4.9	8	5	040	●
M8X1.25	IS02X(6HX)	6.8	6.85	TD8.0NBBWA5	5P	90	22	-	-	8	6.2	9	5	043	●
M10X1.5	IS02X(6HX)	8.5	8.6	TD0100BBWA5	5P	100	24	-	-	10	8	11	5	043	●
DIN 376															
M12X1.75	IS02X(6HX)	10.3	10.36	TG012PBBWA5	5P	110	29	-	-	9	7	10	5	116	●
M14X2	IS02X(6HX)	12	12.12	TG014QBBWA5	5P	110	30	-	-	11	9	12	6	116	●
M16X2	IS02X(6HX)	14	14.12	TG016QBBWA5	5P	110	32	-	-	12	9	12	6	116	●
M18X2.5	IS02X(6HX)	15.5	15.63	TG018RBBWA5	5P	125	34	-	-	14	11	14	6	116	○
M20X2.5	IS02X(6HX)	17.5	17.63	TG020RBBWA5	5P	140	34	-	-	16	12	15	6	116	●

Intro
SP
SL
PO
ST

ROLL

CARBIDE
DIN

LONG

HAND
TAPS

EG (STI)

SPECIAL
THREADS,
GAUGES

THREAD
MILLS

DIES

CENTER
DRILLS

Technical
info

Intro

N-CT FC

MS Material Specific Series

Carbide Taps for Cast Iron



SP

SL



PO

Recommended Tapping Speeds Depending On Materials

ISO	Vc (m/min)	ISO	Vc (m/min)
K1	5÷15 ★	N2	5÷15 ★
K2	5÷15 ★	N4	5÷15 ★
K3	≤10 ☆		
K4	≤8 ☆		

★ 1st choice ☆ suitable

ST

ROLL

CARBIDE

JIS

LONG

HAND TAPS

EG (STI)

SPECIAL THREADS, GAUGES

THREAD MILLS

DIES

CENTER DRILLS

Technical info

FEATURES

Carbide for blind and through hole application.

Specific design for Cast Iron and Brass application.

1.5P chamfer for blind hole application, 3P chamfer for through hole application.

TYPE: CT_001

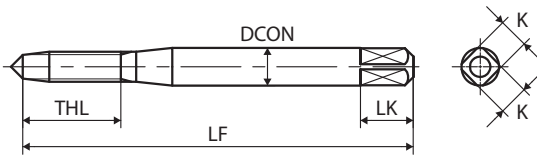

TYPE: CT_004

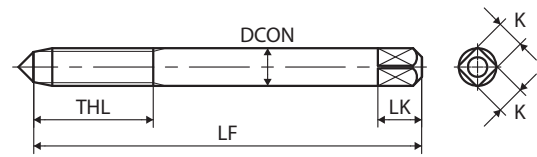

TYPE: CT_015

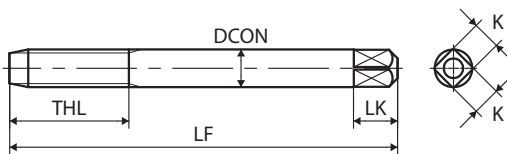

TYPE: CT_007

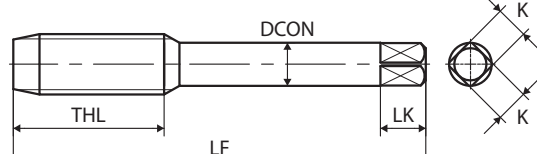

M	TCTR (tolerance)	∅ (mm)	Hole ∅ (mm)	Code	THCHT (chamfer)	LF (mm)	THL (mm)	LU (mm)	LS (mm)	DCON (mm)	K (mm)	LK (mm)	NOF	Type	Stock
JIS															
M1.4X0.3	P3	1.1	1.13	TCNR1.4C3	3P	34	7	-	-	3	2.5	5	3	001	○
	P3	1.1	1.13	TCNR1.4C1	1.5P	34	7	-	-	3	2.5	5	3	001	○
M1.6X0.35	P3	1.25	1.3	TCNR1.6D3	3P	36	8	-	-	3	2.5	5	3	001	○
	P3	1.25	1.3	TCNR1.6D1	1.5P	36	8	-	-	3	2.5	5	3	001	○
M1.7X0.35	P3	1.35	1.4	TCNR1.7D3	3P	36	8	-	-	3	2.5	5	3	001	○
	P3	1.35	1.4	TCNR1.7D1	1.5P	36	8	-	-	3	2.5	5	3	001	○
M2X0.4	P3	1.6	1.65	TCNR2.0E3	3P	40	8	-	-	3	2.5	5	3	001	○
	P3	1.6	1.65	TCNR2.0E1	1.5P	40	8	-	-	3	2.5	5	3	001	○
M2.2X0.45	P3	1.75	1.81	TCNR2.2F3	3P	42	9.5	-	-	3	2.5	5	3	001	○
	P3	1.75	1.81	TCNR2.2F1	1.5P	42	9.5	-	-	3	2.5	5	3	001	○
M2.3X0.4	P3	1.9	1.95	TCNR2.3E3	3P	42	8	-	-	3	2.5	5	3	001	○
	P3	1.9	1.95	TCNR2.3E1	1.5P	42	8	-	-	3	2.5	5	3	001	○
M2.5X0.45	P3	2.1	2.11	TCNR2.5F3	3P	44	9.5	-	-	3	2.5	5	3	001	○
	P3	2.1	2.11	TCNR2.5F1	1.5P	44	9.5	-	-	3	2.5	5	3	001	○
M2.6X0.45	P3	2.2	2.21	TCNR2.6F3	3P	44	9.5	-	-	3	2.5	5	3	001	○
	P3	2.2	2.21	TCNR2.6F1	1.5P	44	9.5	-	-	3	2.5	5	3	001	○
M3X0.5	P3	2.5	2.56	TCNR3.0G3	3P	46	11	-	-	4	3.2	6	3	001	○
	P3	2.5	2.56	TCNR3.0G1	1.5P	46	11	-	-	4	3.2	6	3	001	○
M3.5X0.6	P3	2.9	2.97	TCNR3.5H3	3P	48	11	-	-	4	3.2	6	3	001	○
	P3	2.9	2.97	TCNR3.5H1	1.5P	48	11	-	-	4	3.2	6	3	001	○
M4X0.7	P3	3.3	3.38	TCNR4.0I3	3P	52	13	-	-	5	4	7	4	001	○
	P3	3.3	3.38	TCNR4.0I1	1.5P	52	13	-	-	5	4	7	4	001	○
M5X0.8	P3	4.2	4.28	TCNR5.0K3	3P	60	16	-	-	5.5	4.5	7	4	001	○
	P3	4.2	4.28	TCNR5.0K1	1.5P	60	16	-	-	5.5	4.5	7	4	001	○
M6X1	P3	5	5.09	TCNR6.0M3	3P	62	19	-	-	6	4.5	7	4	004	○
	P3	5	5.09	TCNR6.0M3F	3P	62	19	-	-	6	4.5	7	4	015	○
	P3	5	5.09	TCNR6.0M1	1.5P	62	19	-	-	6	4.5	7	4	004	○
	P3	5	5.09	TCNR6.0M1F	1.5P	62	19	-	-	6	4.5	7	4	015	○
M7X1	P3	6	6.09	TCNR7.0M3	3P	65	19	-	-	6.2	5	8	4	015	○
	P3	6	6.09	TCNR7.0M1	1.5P	65	19	-	-	6.2	5	8	4	015	○
M8X1.25	P3	6.8	6.85	TCNR8.0N3	3P	70	22	-	-	6.2	5	8	4	015	○
	P3	6.8	6.85	TCNR8.0N1	1.5P	70	22	-	-	6.2	5	8	4	015	○
	P4	6.8	6.85	TCNS8.0N3	3P	70	22	-	-	6.2	5	8	4	015	○
	P4	6.8	6.85	TCNS8.0N1	1.5P	70	22	-	-	6.2	5	8	4	015	○
M10X1.5	P3	8.5	8.6	TCNR01003	3P	75	24	-	-	7	5.5	8	4	015	○
	P3	8.5	8.6	TCNR01001	1.5P	75	24	-	-	7	5.5	8	4	015	○
	P4	8.5	8.6	TCNS01003	3P	75	24	-	-	7	5.5	8	4	015	○
	P4	8.5	8.6	TCNS01001	1.5P	75	24	-	-	7	5.5	8	4	015	○
M12X1.75	P3	10.3	10.36	TCNR012P3	3P	82	30	-	-	8.5	6.5	9	4	015	○
	P3	10.3	10.36	TCNR012P1	1.5P	82	30	-	-	8.5	6.5	9	4	015	○
	P4	10.3	10.36	TCNS012P3	3P	82	30	-	-	8.5	6.5	9	4	015	○
	P4	10.3	10.36	TCNS012P1	1.5P	82	30	-	-	8.5	6.5	9	4	015	○
M14X2	P3	12	12.12	TCNR014Q3	3P	88	30	-	-	10.5	8	11	4	015	○
	P3	12	12.12	TCNR014Q1	1.5P	88	30	-	-	10.5	8	11	4	015	○
	P4	12	12.12	TCNS014Q3	3P	88	30	-	-	10.5	8	11	4	015	○
	P4	12	12.12	TCNS014Q1	1.5P	88	30	-	-	10.5	8	11	4	015	○

Intro
SP
SL
PO
ST
ROLL
CARBIDE
JIS
LONG
HAND TAPS
EG (STI)
SPECIAL THREADS, GAUGES
THREAD MILLS
DIES
CENTER DRILLS
Technical info

Carbide Taps



Intro

M	TCTR (tolerance)	\varnothing (mm)	Hole \varnothing (mm)	Code	THCHT (chamfer)	LF (mm)	THL (mm)	LU (mm)	LS (mm)	DCON (mm)	K (mm)	LK (mm)	NOF	Type	Stock
JIS															
M16X2	P4	14	14.12	TCNS016Q3	3P	95	30	-	-	12.5	10	13	4	015	○
	P4	14	14.12	TCNS016Q1	1.5P	95	30	-	-	12.5	10	13	4	015	○
M18X2.5	P4	15.5	15.63	TCNS018R3	3P	100	35	-	-	14	11	14	4	015	○
	P4	15.5	15.63	TCNS018R1	1.5P	100	35	-	-	14	11	14	4	015	○
M20X2.5	P4	17.5	17.63	TCNS020R3	3P	105	35	-	-	15	12	15	4	015	○
	P4	17.5	17.63	TCNS020R1	1.5P	105	35	-	-	15	12	15	4	015	○
M22X2.5	P4	19.5	19.63	TCNS022R3	3P	115	35	-	-	17	13	16	4	015	○
	P4	19.5	19.63	TCNS022R1	1.5P	115	35	-	-	17	13	16	4	015	○
M24X3	P4	21	21.13	TCNS024S3	3P	120	35	-	-	19	15	18	4	015	○
	P4	21	21.13	TCNS024S1	1.5P	120	35	-	-	19	15	18	4	015	○
M30X3.5	P5	26.5	26.63	TCNT030T3	3P	135	45	-	-	23	17	20	4	007	○
	P5	26.5	26.63	TCNT030T1	1.5P	135	45	-	-	23	17	20	4	007	○

ST

MF	TCTR (tolerance)	\varnothing (mm)	Hole \varnothing (mm)	Code	THCHT (chamfer)	LF (mm)	THL (mm)	LU (mm)	LS (mm)	DCON (mm)	K (mm)	LK (mm)	NOF	Type	Stock
JIS															
M3X0.35	P3	2.7	2.7	TCNR3.0D3	3P	46	8	-	-	4	3.2	6	3	001	○
	P3	2.7	2.7	TCNR3.0D1	1.5P	46	8	-	-	4	3.2	6	3	001	○
M4X0.5	P3	3.5	3.56	TCNR4.0G3	3P	52	11	-	-	5	4	7	4	001	○
	P3	3.5	3.56	TCNR4.0G1	1.5P	52	11	-	-	5	4	7	4	001	○
M5X0.5	P3	4.5	4.56	TCNR5.0G3	3P	52	11	-	-	5.5	4.5	7	4	001	○
	P3	4.5	4.56	TCNR5.0G1	1.5P	52	11	-	-	5.5	4.5	7	4	001	○
M6X0.75	P3	5.3	5.33	TCNR6.0J3	3P	62	13	-	-	6	4.5	7	4	004	○
	P3	5.3	5.33	TCNR6.0J1	1.5P	62	13	-	-	6	4.5	7	4	004	○
M6X0.5	P3	5.5	5.56	TCNR6.0G3	3P	55	11	-	-	6	4.5	7	4	004	○
	P3	5.5	5.56	TCNR6.0G1	1.5P	55	11	-	-	6	4.5	7	4	004	○
M7X0.75	P3	6.3	6.33	TCNR7.0J3	3P	62	13	-	-	6.2	5	8	4	015	○
	P3	6.3	6.33	TCNR7.0J1	1.5P	62	13	-	-	6.2	5	8	4	015	○
M8X1	P3	7	7.09	TCNR8.0M3	3P	70	19	-	-	6.2	5	8	4	015	○
	P3	7	7.09	TCNR8.0M1	1.5P	70	19	-	-	6.2	5	8	4	015	○
M8X0.75	P3	7.3	7.33	TCNR8.0J3	3P	62	13	-	-	6.2	5	8	4	015	○
	P3	7.3	7.33	TCNR8.0J1	1.5P	62	13	-	-	6.2	5	8	4	015	○
M10X1.25	P3	8.8	8.85	TCNR010N3	3P	75	22	-	-	7	5.5	8	4	015	○
	P3	8.8	8.85	TCNR010N1	1.5P	75	22	-	-	7	5.5	8	4	015	○
	P4	8.8	8.85	TCNS010N3	3P	75	22	-	-	7	5.5	8	4	015	○
	P4	8.8	8.85	TCNS010N1	1.5P	75	22	-	-	7	5.5	8	4	015	○
M10X1	P3	9	9.09	TCNR010M3	3P	70	19	-	-	7	5.5	8	4	015	○
	P3	9	9.09	TCNR010M1	1.5P	70	19	-	-	7	5.5	8	4	015	○
	P4	9	9.09	TCNS010M3	3P	70	19	-	-	7	5.5	8	4	015	○
	P4	9	9.09	TCNS010M1	1.5P	70	19	-	-	7	5.5	8	4	015	○
M12X1.5	P3	10.5	10.6	TCNR01203	3P	82	24	-	-	8.5	6.5	9	4	015	○
	P3	10.5	10.6	TCNR01201	1.5P	82	24	-	-	8.5	6.5	9	4	015	○
	P4	10.5	10.6	TCNS01203	3P	82	24	-	-	8.5	6.5	9	4	015	○
	P4	10.5	10.6	TCNS01201	1.5P	82	24	-	-	8.5	6.5	9	4	015	○
M12X1.25	P3	10.8	10.85	TCNR012N3	3P	80	22	-	-	8.5	6.5	9	4	015	○
	P3	10.8	10.85	TCNR012N1	1.5P	80	22	-	-	8.5	6.5	9	4	015	○
	P4	10.8	10.85	TCNS012N3	3P	80	22	-	-	8.5	6.5	9	4	015	○
	P4	10.8	10.85	TCNS012N1	1.5P	80	22	-	-	8.5	6.5	9	4	015	○

Technical info

MF	TCTR (tolerance)	 Hole Ø (mm)	Hole Ø (mm)	Code	THCHT (chamfer)	LF (mm)	THL (mm)	LU (mm)	LS (mm)	DCON (mm)	K (mm)	LK (mm)	NOF	Type	Stock
JIS															
M12X1	P3	11	11.09	TCNR012M3	3P	70	19	-	-	8.5	6.5	9	4	015	○
	P3	11	11.09	TCNR012M1	1.5P	70	19	-	-	8.5	6.5	9	4	015	○
	P4	11	11.09	TCNS012M3	3P	70	19	-	-	8.5	6.5	9	4	015	○
	P4	11	11.09	TCNS012M1	1.5P	70	19	-	-	8.5	6.5	9	4	015	○
M14X1.5	P3	12.5	12.6	TCNR01403	3P	88	24	-	-	10.5	8	11	4	015	○
	P3	12.5	12.6	TCNR01401	1.5P	88	24	-	-	10.5	8	11	4	015	○
	P4	12.5	12.6	TCNS01403	3P	88	24	-	-	10.5	8	11	4	015	○
	P4	12.5	12.6	TCNS01401	1.5P	88	24	-	-	10.5	8	11	4	015	○
M14X1.25	P3	12.8	12.85	TCNR014N3	3P	88	22	-	-	10.5	8	11	4	015	○
	P3	12.8	12.85	TCNR014N1	1.5P	88	22	-	-	10.5	8	11	4	015	○
	P4	12.8	12.85	TCNS014N3	3P	88	22	-	-	10.5	8	11	4	015	○
	P4	12.8	12.85	TCNS014N1	1.5P	88	22	-	-	10.5	8	11	4	015	○
M14X1	P3	13	13.09	TCNR014M3	3P	70	19	-	-	10.5	8	11	4	015	○
	P3	13	13.09	TCNR014M1	1.5P	70	19	-	-	10.5	8	11	4	015	○
	P4	13	13.09	TCNS014M3	3P	70	19	-	-	10.5	8	11	4	015	○
	P4	13	13.09	TCNS014M1	1.5P	70	19	-	-	10.5	8	11	4	015	○
M16X1.5	P3	14.5	14.6	TCNR01603	3P	95	24	-	-	12.5	10	13	4	015	○
	P3	14.5	14.6	TCNR01601	1.5P	95	24	-	-	12.5	10	13	4	015	○
	P4	14.5	14.6	TCNS01603	3P	95	24	-	-	12.5	10	13	4	015	○
	P4	14.5	14.6	TCNS01601	1.5P	95	24	-	-	12.5	10	13	4	015	○
M16X1	P4	15	15.09	TCNS016M3	3P	75	19	-	-	12.5	10	13	4	015	○
	P4	15	15.09	TCNS016M1	1.5P	75	19	-	-	12.5	10	13	4	015	○
M18X1.5	P4	16.5	16.6	TCNS01803	3P	95	24	-	-	14	11	14	4	015	○
	P4	16.5	16.6	TCNS01801	1.5P	95	24	-	-	14	11	14	4	015	○
M20X1.5	P4	18.5	18.6	TCNS02003	3P	95	24	-	-	15	12	15	4	015	○
	P4	18.5	18.6	TCNS02001	1.5P	95	24	-	-	15	12	15	4	015	○
M22X1.5	P4	20.5	20.6	TCNS02203	3P	95	24	-	-	17	13	16	4	015	○
	P4	20.5	20.6	TCNS02201	1.5P	95	24	-	-	17	13	16	4	015	○
M24X1.5	P4	22.5	22.6	TCNS02403	3P	95	24	-	-	19	15	18	4	015	○
	P4	22.5	22.6	TCNS02401	1.5P	95	24	-	-	19	15	18	4	015	○
JIS															
UNC	TCTR (tolerance)	 Hole Ø (mm)	Hole Ø (mm)	Code	THCHT (chamfer)	LF (mm)	THL (mm)	LU (mm)	LS (mm)	DCON (mm)	K (mm)	LK (mm)	NOF	Type	Stock
JIS															
No.4-40UNC	P3	2.3	2.33	TCNRUN4H3	3P	44	9.5	-	-	3	2.5	5	3	001	○
	P3	2.3	2.33	TCNRUN4H1	1.5P	44	9.5	-	-	3	2.5	5	3	001	○
No.5-40UNC	P3	2.6	2.64	TCNRUN5H3	3P	46	9.5	-	-	4	3.2	6	3	001	○
	P3	2.6	2.64	TCNRUN5H1	1.5P	46	9.5	-	-	4	3.2	6	3	001	○
No.6-32UNC	P3	2.8	2.83	TCNRUN6J3	3P	48	11	-	-	4	3.2	6	3	001	○
	P3	2.8	2.83	TCNRUN6J1	1.5P	48	11	-	-	4	3.2	6	3	001	○
No.8-32UNC	P3	3.4	3.47	TCNRUN8J3	3P	52	11	-	-	5	4	7	4	001	○
	P3	3.4	3.47	TCNRUN8J1	1.5P	52	11	-	-	5	4	7	4	001	○
No.10-24UNC	P3	3.89	3.9	TCNRUNAM3	3P	60	16	-	-	5.5	4.5	7	4	001	○
	P3	3.89	3.9	TCNRUNAM1	1.5P	60	16	-	-	5.5	4.5	7	4	001	○
1/4-20UNC	P3	5.1	5.19	TCNRU04N3	3P	62	19	-	-	6	4.5	7	4	004	○
	P3	5.1	5.19	TCNRU04N1	1.5P	62	19	-	-	6	4.5	7	4	004	○
5/16-18UNC	P3	6.6	6.65	TCNRU0503	3P	70	22	-	-	6.1	5	8	4	015	○
	P3	6.6	6.65	TCNRU0501	1.5P	70	22	-	-	6.1	5	8	4	015	○

Intro
SP
SL
PO
ST
ROLL
CARBIDE
JIS
LONG
HAND TAPS
EG (STI)
SPECIAL THREADS, GAUGES
THREAD MILLS
DIES
CENTER DRILLS
Technical info

Carbide Taps

Intro

SP

SL

PO

ST

ROLL

CARBIDE

JIS

LONG

HAND
TAPS

EG (STI)

SPECIAL
THREADS,
GAUGES

THREAD
MILLS

DIES

CENTER
DRILLS

Technical
info

UNC	TCTR (tolerance)	 Hole Ø (mm)	Hole Ø (mm)	Code	THCHT (chamfer)	LF (mm)	THL (mm)	LU (mm)	LS (mm)	DCON (mm)	K (mm)	LK (mm)	NOF	Type	Stock
JIS															
3/8-16UNC	P3	8	8.07	TCNRU06P3	3P	75	24	-	-	7	5.5	8	4	015	○
	P3	8	8.07	TCNRU06P1	1.5P	75	24	-	-	7	5.5	8	4	015	○
7/16-14UNC	P3	9.4	9.45	TCNRU07Q3	3P	80	24	-	-	8	6	9	4	015	○
	P3	9.4	9.45	TCNRU07Q1	1.5P	80	24	-	-	8	6	9	4	015	○
1/2-13UNC	P3	10.9	10.91	TCNRU08R3	3P	85	30	-	-	9	7	10	4	015	○
	P3	10.9	10.91	TCNRU08R1	1.5P	85	30	-	-	9	7	10	4	015	○
5/8-11UNC	P4	13.6	13.75	TCNSU10U3	3P	95	30	-	-	12	9	12	4	015	○
	P4	13.6	13.75	TCNSU10U1	1.5P	95	30	-	-	12	9	12	4	015	○
3/4-10UNC	P4	16.6	16.7	TCNSU12V3	3P	105	35	-	-	14	11	14	4	015	○
	P4	16.6	16.7	TCNSU12V1	1.5P	105	35	-	-	14	11	14	4	015	○
UNF															
JIS															
No.4-48UNF	P3	2.4	2.41	TCNRUN4F3	3P	44	9.5	-	-	3	2.5	5	3	001	○
	P3	2.4	2.41	TCNRUN4F1	1.5P	44	9.5	-	-	3	2.5	5	3	001	○
No.10-32UNF	P3	4.1	4.12	TCNRUNAJ3	3P	60	11	-	-	5.5	4.5	7	4	001	○
	P3	4.1	4.12	TCNRUNAJ1	1.5P	60	11	-	-	5.5	4.5	7	4	001	○
1/4-28UNF	P3	5.5	5.53	TCNRU04K3	3P	62	16	-	-	6	4.5	7	4	004	○
	P3	5.5	5.53	TCNRU04K1	1.5P	62	16	-	-	6	4.5	7	4	004	○
5/16-24UNF	P3	6.9	6.97	TCNRU05M3	3P	70	16	-	-	6.1	5	8	4	015	○
	P3	6.9	6.97	TCNRU05M1	1.5P	70	16	-	-	6.1	5	8	4	015	○
3/8-24UNF	P3	8.5	8.57	TCNRU06M3	3P	75	16	-	-	7	5.5	8	4	015	○
	P3	8.5	8.57	TCNRU06M1	1.5P	75	16	-	-	7	5.5	8	4	015	○
7/16-20UNF	P3	9.9	9.96	TCNRU07N3	3P	80	19	-	-	8	6	9	4	015	○
	P3	9.9	9.96	TCNRU07N1	1.5P	80	19	-	-	8	6	9	4	015	○
1/2-20UNF	P3	11.5	11.54	TCNRU08N3	3P	85	19	-	-	9	7	10	4	015	○
	P3	11.5	11.54	TCNRU08N1	1.5P	85	19	-	-	9	7	10	4	015	○
5/8-18UNF	P4	14.5	14.6	TCNSU1003	3P	95	22	-	-	12	9	12	4	015	○
	P4	14.5	14.6	TCNSU1001	1.5P	95	22	-	-	12	9	12	4	015	○
3/4-16UNF	P4	17.5	17.59	TCNSU12P3	3P	95	24	-	-	14	11	14	4	015	○
	P4	17.5	17.59	TCNSU12P1	1.5P	95	24	-	-	14	11	14	4	015	○

CT-PF

MS Material Specific Series

Carbide Taps for Parallel Pipe Threads, for Cast Iron and Non-Ferrous Materials



FEATURES

Carbide for blind and through hole application.
Specific design for Cast Iron and Brass application.

Recommended Tapping Speeds Depending On Materials

ISO	Vc (m/min)	ISO	Vc (m/min)
K1	5÷15 ★	N2	5÷10 ★
K2	5÷15 ★	N4	5÷10 ★
K3	≤10 ☆		
K4	≤8 ☆		

★ 1st choice ☆ suitable

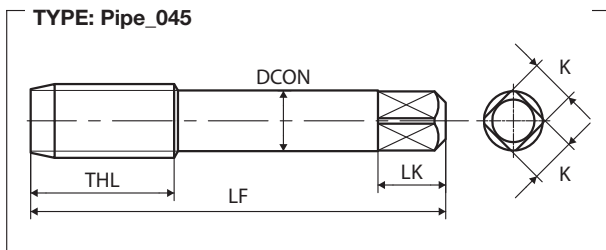

G(BSP)	TCTR (tolerance)	∅ (mm)	Hole ∅ (mm)	Code	THCHT (chamfer)	Basic major ∅ (mm)	LF (mm)	THL (mm)	LS (mm)	DCON (mm)	K (mm)	LK (mm)	NOF	Type	Stock
JIS															
1/8-28	II	8.75	8.78	TCPF02K	3.5P	9.728	55	19	-	8	6	9	4	045	○
1/4-19	II	11.75	11.78	TCPF04-	3.5P	13.157	62	28	-	11	9	12	4	045	○
3/8-19	II	15.25	15.28	TCPF06-	3.5P	16.662	65	28	-	14	11	14	4	045	○
1/2-14	II	19	19.04	TCPF08Q	3.5P	20.955	80	35	-	18	14	17	4	045	○
3/4-14	II	24.5	24.52	TCPF12Q	3.5P	26.441	85	35	-	23	17	20	4	045	○
1-11	II	30.75	30.77	TCPF16U	3.5P	33.249	95	45	-	26	21	24	4	045	○

Intro

SP

SL

PO

ST

ROLL

CARBIDE

JIS

LONG

HAND TAPS

EG (STI)

SPECIAL THREADS, GAUGES

THREAD MILLS

DIES

CENTER DRILLS

Technical info

Intro

LS-N-CT

MS Material Specific Series

SP

Long Shank Carbide Taps

SL



PO

Recommended Tapping Speeds Depending On Materials

ISO	Vc (m/min)	ISO	Vc (m/min)
K1	5÷15 ★	N2	5÷15 ★
K2	5÷15 ★	N4	5÷15 ★
K3	≤10 ☆		
K4	≤8 ☆		

★ 1st choice ☆ suitable

ROLL

CARBIDE

JIS

LONG

HAND TAPS

EG (STI)

SPECIAL THREADS, GAUGES

THREAD MILLS

DIES

CENTER DRILLS

Technical info



FEATURES

Carbide long shank for extended overhang on blind and through hole application.

Specific design for Cast Iron and Brass application.

1.5P chamfer for blind hole application, 3P chamfer for through hole application.

TYPE: CT_005

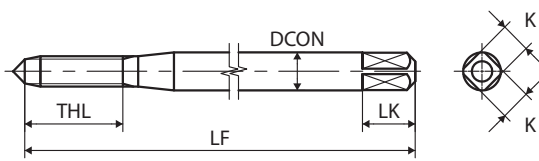

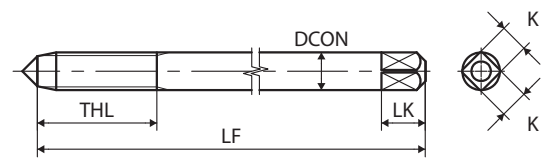

TYPE: CT_008

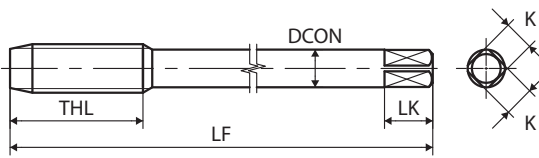

TYPE: CT_011



M	TCTR (tolerance)	Hole Ø (mm)	Hole Ø (mm)	Code	THCHT (chamfer)	LF (mm)	THL (mm)	LU (mm)	LS (mm)	DCON (mm)	K (mm)	LK (mm)	NOF	Type	Stock
JIS															
M3X0.5	P3	2.5	2.56	TY3.0GRAWB3E	3P	100	11	-	-	4	3.2	6	3	005	○
	P3	2.5	2.56	TY3.0GRAWBAE	1.5P	100	11	-	-	4	3.2	6	3	005	○
M4X0.7	P3	3.3	3.38	TY4.0IRAWB3E	3P	100	13	-	-	5	4	7	4	005	○
	P3	3.3	3.38	TY4.0IRAWBAE	1.5P	100	13	-	-	5	4	7	4	005	○
M5X0.8	P3	4.2	4.28	TY5.0KRAWB3E	3P	100	16	-	-	5.5	4.5	7	4	005	○
	P3	4.2	4.28	TY5.0KRAWBAE	1.5P	100	16	-	-	5.5	4.5	7	4	005	○
M6X1	P3	5	5.09	TY6.0MRAWB3E	3P	100	19	-	-	6	4.5	7	4	008	○
	P3	5	5.09	TY6.0MRAWBAE	1.5P	100	19	-	-	6	4.5	7	4	008	○

M	TCTR (tolerance)	 Hole Ø (mm)	Hole Ø (mm)	Code	THCHT (chamfer)	LF (mm)	THL (mm)	LU (mm)	LS (mm)	DCON (mm)	K (mm)	LK (mm)	NOF	Type	Stock
JIS															
M8X1.25	P3	6.8	6.85	TY8.ONRAWB3E	3P	100	22	-	-	6.2	5	8	4	011	○
	P3	6.8	6.85	TY8.ONRAWB3G	3P	150	22	-	-	6.2	5	8	4	011	○
	P3	6.8	6.85	TY8.ONRAWBAE	1.5P	100	22	-	-	6.2	5	8	4	011	○
	P3	6.8	6.85	TY8.ONRAWBAG	1.5P	150	22	-	-	6.2	5	8	4	011	○
M10X1.5	P3	8.5	8.6	TY010ORAWB3E	3P	100	24	-	-	7	5.5	8	4	011	○
	P3	8.5	8.6	TY010ORAWB3G	3P	150	24	-	-	7	5.5	8	4	011	○
	P3	8.5	8.6	TY010ORAWBAE	1.5P	100	24	-	-	7	5.5	8	4	011	○
	P3	8.5	8.6	TY010ORAWBAG	1.5P	150	24	-	-	7	5.5	8	4	011	○
M12X1.75	P4	10.3	10.36	TY012PSAWB3G	3P	150	30	-	-	8.5	6.5	9	4	011	○
	P4	10.3	10.36	TY012PSAWBAG	1.5P	150	30	-	-	8.5	6.5	9	4	011	○
M14X2	P4	12	12.12	TY014QSAWB3G	3P	150	30	-	-	10.5	8	11	4	011	○
	P4	12	12.12	TY014QSAWBAG	1.5P	150	30	-	-	10.5	8	11	4	011	○
M16X2	P4	14	14.12	TY016QSAWB3G	3P	150	30	-	-	12.5	10	13	4	011	○
	P4	14	14.12	TY016QSAWBAG	1.5P	150	30	-	-	12.5	10	13	4	011	○
M18X2.5	P4	15.5	15.63	TY018RSAWB3G	3P	150	35	-	-	14	11	14	4	011	○
	P4	15.5	15.63	TY018RSAWBAG	1.5P	150	35	-	-	14	11	14	4	011	○
M20X2.5	P4	17.5	17.63	TY020RSAWB3G	3P	150	35	-	-	15	12	15	4	011	○
	P4	17.5	17.63	TY020RSAWBAG	1.5P	150	35	-	-	15	12	15	4	011	○
M22X2.5	P4	19.5	19.63	TY022RSAWB3G	3P	150	35	-	-	17	13	16	4	011	○
	P4	19.5	19.63	TY022RSAWBAG	1.5P	150	35	-	-	17	13	16	4	011	○
M24X3	P4	21	21.13	TY024SSAWB3G	3P	150	35	-	-	19	15	18	4	011	○
	P4	21	21.13	TY024SSAWBAG	1.5P	150	35	-	-	19	15	18	4	011	○
JIS															
MF	TCTR (tolerance)	 Hole Ø (mm)	Hole Ø (mm)	Code	THCHT (chamfer)	LF (mm)	THL (mm)	LU (mm)	LS (mm)	DCON (mm)	K (mm)	LK (mm)	NOF	Type	Stock
JIS															
M10X1.25	P3	8.8	8.85	TY010NRAWB3E	3P	100	22	-	-	7	5.5	8	4	011	○
	P3	8.8	8.85	TY010NRAWB3G	3P	150	22	-	-	7	5.5	8	4	011	○
	P3	8.8	8.85	TY010NRAWBAE	1.5P	100	22	-	-	7	5.5	8	4	011	○
	P3	8.8	8.85	TY010NRAWBAG	1.5P	150	22	-	-	7	5.5	8	4	011	○
M12X1.5	P4	10.5	10.6	TY0120SAWB3G	3P	150	24	-	-	8.5	6.5	9	4	011	○
	P4	10.5	10.6	TY0120SAWBAG	1.5P	150	24	-	-	8.5	6.5	9	4	011	○
M12X1.25	P4	10.8	10.85	TY012NSAWB3G	3P	150	22	-	-	8.5	6.5	9	4	011	○
	P4	10.8	10.85	TY012NSAWBAG	1.5P	150	22	-	-	8.5	6.5	9	4	011	○
M14X1.5	P4	12.5	12.6	TY0140SAWB3G	3P	150	24	-	-	10.5	8	11	4	011	○
	P4	12.5	12.6	TY0140SAWBAG	1.5P	150	24	-	-	10.5	8	11	4	011	○
M16X1.5	P4	14.5	14.6	TY0160SAWB3G	3P	150	24	-	-	12.5	10	13	4	011	○
	P4	14.5	14.6	TY0160SAWBAG	1.5P	150	24	-	-	12.5	10	13	4	011	○
M18X1.5	P4	16.5	16.6	TY0180SAWB3G	3P	150	24	-	-	14	11	14	4	011	○
	P4	16.5	16.6	TY0180SAWBAG	1.5P	150	24	-	-	14	11	14	4	011	○
M20X1.5	P4	18.5	18.6	TY0200SAWB3G	3P	150	24	-	-	15	12	15	4	011	○
	P4	18.5	18.6	TY0200SAWBAG	1.5P	150	24	-	-	15	12	15	4	011	○
M22X1.5	P4	20.5	20.6	TY0220SAWB3G	3P	150	24	-	-	17	13	16	4	011	○
	P4	20.5	20.6	TY0220SAWBAG	1.5P	150	24	-	-	17	13	16	4	011	○
M24X1.5	P4	22.5	22.6	TY0240SAWB3G	3P	150	24	-	-	19	15	18	4	011	○
	P4	22.5	22.6	TY0240SAWBAG	1.5P	150	24	-	-	19	15	18	4	011	○

Intro

SP

SL

PO

ST

ROLL

CARBIDE

JIS

LONG

HAND TAPS

EG (STI)

SPECIAL THREADS, GAUGES

THREAD MILLS

DIES

CENTER DRILLS

Technical info

Intro

N-CT-SP

MS Material Specific Series

SP

Carbide Taps Spiral Fluted for Non-Ferrous Materials

SL



PO

Recommended Tapping Speeds Depending On Materials

ISO Vc (m/min)

N1 10÷20 ★

N2 10÷20 ★

N4 10÷20 ★

ST

★ 1st choice ☆ suitable

ROLL

CARBIDE

JIS

LONG

HAND TAPS

EG (STI)

SPECIAL THREADS, GAUGES

THREAD MILLS

DIES

CENTER DRILLS

Technical info



FEATURES

Carbide low spiral fluted for blind hole application.

Specific design for Aluminium casting, Aluminium die-casting and other non-ferrous materials.

TYPE: CT_001

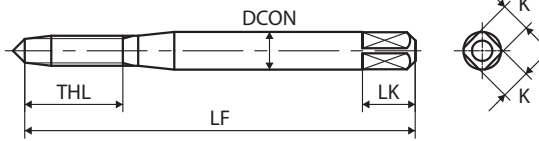

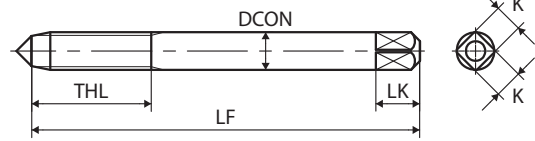

TYPE: CT_004

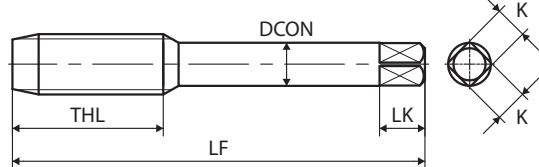

TYPE: CT_007



M	TCTR (tolerance)	 Hole Ø (mm)	Hole Ø (mm)	Code	THCHT (chamfer)	LF (mm)	THL (mm)	LU (mm)	LS (mm)	DCON (mm)	K (mm)	LK (mm)	NOF	Type	Stock
JIS															
M3X0.5	P3	2.5	2.56	SY3.0GRKWB	2.5P	46	11	-	-	4	3.2	6	3	001	○
M4X0.7	P3	3.3	3.38	SY4.0IRKWB	2.5P	52	13	-	-	5	4	7	3	001	○
M5X0.8	P3	4.2	4.28	SY5.0KRKWB	2.5P	60	16	-	-	5.5	4.5	7	3	001	○
M6X1	P3	5	5.09	SY6.0MRKWB	2.5P	62	19	-	-	6	4.5	7	3	004	○
M8X1.25	P3	6.8	6.85	SY8.0NRKWB	2.5P	70	22	-	-	6.2	5	8	3	007	○
M10X1.5	P3	8.5	8.6	SY0100RKWB	2.5P	75	24	-	-	7	5.5	8	3	007	○
M12X1.75	P4	10.3	10.36	SY012PSKWB	2.5P	82	30	-	-	8.5	6.5	9	3	007	○
M14X2	P4	12	12.12	SY014QSKWB	2.5P	88	30	-	-	10.5	8	11	3	007	○
M16X2	P4	14	14.12	SY016QSKWB	2.5P	95	30	-	-	12.5	10	13	3	007	○
M18X2.5	P4	15.5	15.63	SY018RSKWB	2.5P	100	35	-	-	14	11	14	4	007	○
M20X2.5	P4	17.5	17.63	SY020RSKWB	2.5P	105	35	-	-	15	12	15	4	007	○
JIS															
MF	TCTR (tolerance)	 Hole Ø (mm)	Hole Ø (mm)	Code	THCHT (chamfer)	LF (mm)	THL (mm)	LU (mm)	LS (mm)	DCON (mm)	K (mm)	LK (mm)	NOF	Type	Stock
JIS															
M10X1.25	P3	8.8	8.85	SY010NRKWB	2.5P	75	22	-	-	7	5.5	8	3	007	○
M12X1.5	P4	10.5	10.6	SY012OSKWB	2.5P	82	24	-	-	8.5	6.5	9	3	007	○
M12X1.25	P4	10.8	10.85	SY012NSKWB	2.5P	80	22	-	-	8.5	6.5	9	3	007	○
M14X1.5	P4	12.5	12.6	SY014OSKWB	2.5P	88	24	-	-	10.5	8	11	3	007	○
M16X1.5	P4	14.5	14.6	SY016OSKWB	2.5P	95	24	-	-	12.5	10	13	3	007	○
M18X1.5	P4	16.5	16.6	SY018OSKWB	2.5P	95	24	-	-	14	11	14	4	007	○
M20X1.5	P4	18.5	18.6	SY020OSKWB	2.5P	95	24	-	-	15	12	15	4	007	○

Intro

SP

SL

PO

ST

ROLL

CARBIDE

JIS

LONG

HAND TAPS

EG (STI)

SPECIAL THREADS, GAUGES

THREAD MILLS

DIES

CENTER DRILLS

Technical info

Intro

N-CT-PO

MS Material Specific Series

SP

Carbide Taps Spiral Pointed for Non-Ferrous Materials

SL



PO

Recommended Tapping Speeds Depending On Materials

ISO	Vc (m/min)
N1	10÷20 ★
N2	10÷20 ★
N4	10÷20 ★

ST

★ 1st choice ☆ suitable

ROLL

CARBIDE

JIS

LONG

HAND TAPS

EG (STI)

SPECIAL THREADS, GAUGES

THREAD MILLS

DIES

CENTER DRILLS

Technical info



FEATURES

Carbide for through hole application.

Specific design for Aluminium casting, Aluminium die-casting and other non-ferrous materials.

TYPE: CT_001

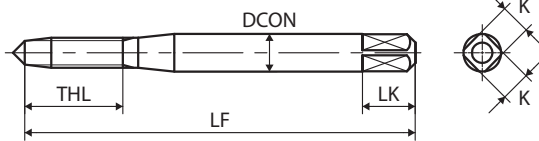

TYPE: CT_004

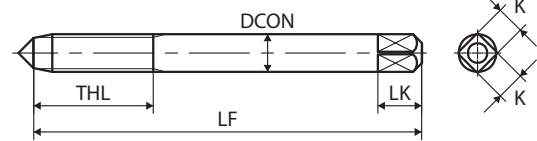

TYPE: CT_007

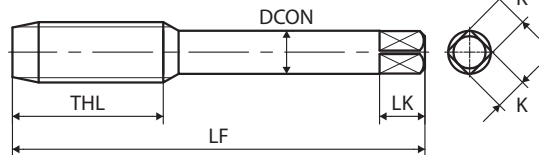

M	TCTR (tolerance)	 Hole Ø (mm)	Hole Ø (mm)	Code	THCHT (chamfer)	LF (mm)	THL (mm)	LU (mm)	LS (mm)	DCON (mm)	K (mm)	LK (mm)	NOF	Type	Stock
JIS															
M3X0.5	P3	2.5	2.56	PCNR3.0G	5P	46	11	-	-	4	3.2	6	3	001	○
M4X0.7	P3	3.3	3.38	PCNR4.0I	5P	52	13	-	-	5	4	7	3	001	○
M5X0.8	P3	4.2	4.28	PCNR5.0K	5P	60	16	-	-	5.5	4.5	7	3	001	○
M6X1	P3	5	5.09	PCNR6.0M	5P	62	19	-	-	6	4.5	7	3	004	○
M8X1.25	P3	6.8	6.85	PCNR8.0N	5P	70	22	-	-	6.2	5	8	3	007	○
M10X1.5	P4	8.5	8.6	PCNS0100	5P	75	24	-	-	7	5.5	8	3	007	○
M12X1.75	P4	10.3	10.36	PCNS012P	5P	82	30	-	-	8.5	6.5	9	3	007	○

Intro

SP

SL

PO

ST

ROLL

CARBIDE

JIS

LONG

HAND
TAPS

EG (STI)

SPECIAL
THREADS,
GAUGESTHREAD
MILLS

DIES

CENTER
DRILLSTechnical
info

Intro

N-CT LA

MS Material Specific Series

Carbide Taps for Light Alloys



SP

SL



PO

Recommended Tapping Speeds Depending On Materials

ISO	Vc (m/min)
N1	10÷20 ★
N2	10÷20 ★
N4	10÷20 ★

★ 1st choice ☆ suitable

ST

ROLL

CARBIDE

JIS

LONG

HAND TAPS

EG (STI)

SPECIAL THREADS, GAUGES

THREAD MILLS

DIES

CENTER DRILLS

Technical info

FEATURES

Carbide for blind and through hole application.

Specific design for Aluminium casting, Aluminium die-casting and other non-ferrous materials.

1.5P chamfer for blind hole application, 3P chamfer for through hole application.

TYPE: CT_001

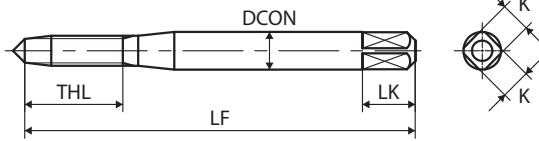

TYPE: CT_004

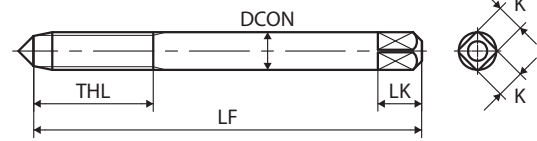

TYPE: CT_007

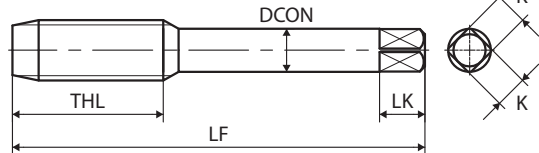

M	TCTR (tolerance)	 Hole Ø (mm)	Hole Ø (mm)	Code	THCHT (chamfer)	LF (mm)	THL (mm)	LU (mm)	LS (mm)	DCON (mm)	K (mm)	LK (mm)	NOF	Type	Stock
JIS															
M1.4X0.3	P3	1.1	1.13	TCNR1.4C3A	3P	34	7	-	-	3	2.5	5	3	001	○
	P3	1.1	1.13	TCNR1.4C1A	1.5P	34	7	-	-	3	2.5	5	3	001	○
M1.6X0.35	P3	1.25	1.3	TCNR1.6D3A	3P	36	8	-	-	3	2.5	5	3	001	○
	P3	1.25	1.3	TCNR1.6D1A	1.5P	36	8	-	-	3	2.5	5	3	001	○
M1.7X0.35	P3	1.35	1.4	TCNR1.7D3A	3P	36	8	-	-	3	2.5	5	3	001	○
	P3	1.35	1.4	TCNR1.7D1A	1.5P	36	8	-	-	3	2.5	5	3	001	○
M2X0.4	P3	1.6	1.65	TCNR2.0E3A	3P	40	8	-	-	3	2.5	5	3	001	○
	P3	1.6	1.65	TCNR2.0E1A	1.5P	40	8	-	-	3	2.5	5	3	001	○
M2.2X0.45	P3	1.75	1.81	TCNR2.2F3A	3P	42	9.5	-	-	3	2.5	5	3	001	○
	P3	1.75	1.81	TCNR2.2F1A	1.5P	42	9.5	-	-	3	2.5	5	3	001	○
M2.3X0.4	P3	1.9	1.95	TCNR2.3E3A	3P	42	8	-	-	3	2.5	5	3	001	○
	P3	1.9	1.95	TCNR2.3E1A	1.5P	42	8	-	-	3	2.5	5	3	001	○
M2.5X0.45	P3	2.1	2.11	TCNR2.5F3A	3P	44	9.5	-	-	3	2.5	5	3	001	○
	P3	2.1	2.11	TCNR2.5F1A	1.5P	44	9.5	-	-	3	2.5	5	3	001	○
M2.6X0.45	P3	2.2	2.21	TCNR2.6F3A	3P	44	9.5	-	-	3	2.5	5	3	001	○
	P3	2.2	2.21	TCNR2.6F1A	1.5P	44	9.5	-	-	3	2.5	5	3	001	○
M3X0.5	P3	2.5	2.56	TCNR3.0G3A	3P	46	11	-	-	4	3.2	6	3	001	○
	P3	2.5	2.56	TCNR3.0G1A	1.5P	46	11	-	-	4	3.2	6	3	001	○
M3.5X0.6	P3	2.9	2.97	TCNR3.5H3A	3P	48	11	-	-	4	3.2	6	3	001	○
	P3	2.9	2.97	TCNR3.5H1A	1.5P	48	11	-	-	4	3.2	6	3	001	○
M4X0.7	P3	3.3	3.38	TCNR4.0I3A	3P	52	13	-	-	5	4	7	3	001	○
	P3	3.3	3.38	TCNR4.0I1A	1.5P	52	13	-	-	5	4	7	3	001	○
M5X0.8	P3	4.2	4.28	TCNR5.0K3A	3P	60	16	-	-	5.5	4.5	7	3	001	○
	P3	4.2	4.28	TCNR5.0K1A	1.5P	60	16	-	-	5.5	4.5	7	3	001	○
M6X1	P3	5	5.09	TCNR6.0M3A	3P	62	19	-	-	6	4.5	7	3	004	○
	P3	5	5.09	TCNR6.0M1A	1.5P	62	19	-	-	6	4.5	7	3	004	○
M7X1	P3	6	6.09	TCNR7.0M3A	3P	65	19	-	-	6.2	5	8	3	007	○
	P3	6	6.09	TCNR7.0M1A	1.5P	65	19	-	-	6.2	5	8	3	007	○
M8X1.25	P3	6.8	6.85	TCNR8.0N3A	3P	70	22	-	-	6.2	5	8	3	007	○
	P3	6.8	6.85	TCNR8.0N1A	1.5P	70	22	-	-	6.2	5	8	3	007	○
	P4	6.8	6.85	TCNS8.0N3A	3P	70	22	-	-	6.2	5	8	3	007	○
	P4	6.8	6.85	TCNS8.0N1A	1.5P	70	22	-	-	6.2	5	8	3	007	○
M10X1.5	P3	8.5	8.6	TCNR01003A	3P	75	24	-	-	7	5.5	8	3	007	○
	P3	8.5	8.6	TCNR01001A	1.5P	75	24	-	-	7	5.5	8	3	007	○
	P4	8.5	8.6	TCNS01003A	3P	75	24	-	-	7	5.5	8	3	007	○
	P4	8.5	8.6	TCNS01001A	1.5P	75	24	-	-	7	5.5	8	3	007	○
M12X1.75	P3	10.3	10.36	TCNR012P3A	3P	82	30	-	-	8.5	6.5	9	3	007	○
	P3	10.3	10.36	TCNR012P1A	1.5P	82	30	-	-	8.5	6.5	9	3	007	○
	P4	10.3	10.36	TCNS012P3A	3P	82	30	-	-	8.5	6.5	9	3	007	○
	P4	10.3	10.36	TCNS012P1A	1.5P	82	30	-	-	8.5	6.5	9	3	007	○
M14X2	P3	12	12.12	TCNR014Q3A	3P	88	30	-	-	10.5	8	11	4	007	○
	P3	12	12.12	TCNR014Q1A	1.5P	88	30	-	-	10.5	8	11	4	007	○
	P4	12	12.12	TCNS014Q3A	3P	88	30	-	-	10.5	8	11	4	007	○
	P4	12	12.12	TCNS014Q1A	1.5P	88	30	-	-	10.5	8	11	4	007	○
M16X2	P4	14	14.12	TCNS016Q3A	3P	95	30	-	-	12.5	10	13	4	007	○
	P4	14	14.12	TCNS016Q1A	1.5P	95	30	-	-	12.5	10	13	4	007	○

Intro

SP

SL

PO

ST

ROLL

CARBIDE

JIS

LONG

HAND TAPS

EG (STI)

SPECIAL THREADS, GAUGES

THREAD MILLS

DIES

CENTER DRILLS

Technical info

Carbide Taps

Intro

M	TCTR (tolerance)	 Hole Ø (mm)	Hole Ø (mm)	Code	THCHT (chamfer)	LF (mm)	THL (mm)	LU (mm)	LS (mm)	DCON (mm)	K (mm)	LK (mm)	NOF	Type	Stock
JIS															

SP

M18X2.5	P4	15.5	15.63	TCNS018R3A	3P	100	35	-	-	14	11	14	4	007	○
	P4	15.5	15.63	TCNS018R1A	1.5P	100	35	-	-	14	11	14	4	007	○
M20X2.5	P4	17.5	17.63	TCNS020R3A	3P	105	35	-	-	15	12	15	4	007	○
	P4	17.5	17.63	TCNS020R1A	1.5P	105	35	-	-	15	12	15	4	007	○

SL

MF	TCTR (tolerance)	 Hole Ø (mm)	Hole Ø (mm)	Code	THCHT (chamfer)	LF (mm)	THL (mm)	LU (mm)	LS (mm)	DCON (mm)	K (mm)	LK (mm)	NOF	Type	Stock
JIS															

PO

M4X0.5	P3	3.5	3.56	TCNR4.0G3A	3P	52	11	-	-	5	4	7	3	001	○
	P3	3.5	3.56	TCNR4.0G1A	1.5P	52	11	-	-	5	4	7	3	001	○
M5X0.5	P3	4.5	4.56	TCNR5.0G3A	3P	52	11	-	-	5.5	4.5	7	3	001	○
	P3	4.5	4.56	TCNR5.0G1A	1.5P	52	11	-	-	5.5	4.5	7	3	001	○

ST

M6X0.75	P3	5.3	5.33	TCNR6.0J3A	3P	62	13	-	-	6	4.5	7	3	004	○
	P3	5.3	5.33	TCNR6.0J1A	1.5P	62	13	-	-	6	4.5	7	3	004	○
M6X0.5	P3	5.5	5.56	TCNR6.0G3A	3P	55	11	-	-	6	4.5	7	3	004	○
	P3	5.5	5.56	TCNR6.0G1A	1.5P	55	11	-	-	6	4.5	7	3	004	○

ROLL

M7X0.75	P3	6.3	6.33	TCNR7.0J3A	3P	62	13	-	-	6.2	5	8	3	007	○
	P3	6.3	6.33	TCNR7.0J1A	1.5P	62	13	-	-	6.2	5	8	3	007	○
M8X1	P3	7	7.09	TCNR8.0M3A	3P	70	19	-	-	6.2	5	8	3	007	○
	P3	7	7.09	TCNR8.0M1A	1.5P	70	19	-	-	6.2	5	8	3	007	○

CARBIDE

JIS

M8X0.75	P3	7.3	7.33	TCNR8.0J3A	3P	62	13	-	-	6.2	5	8	3	007	○
	P3	7.3	7.33	TCNR8.0J1A	1.5P	62	13	-	-	6.2	5	8	3	007	○
M10X1.25	P3	8.8	8.85	TCNR010N3A	3P	75	22	-	-	7	5.5	8	3	007	○
	P3	8.8	8.85	TCNR010N1A	1.5P	75	22	-	-	7	5.5	8	3	007	○
	P4	8.8	8.85	TCNS010N3A	3P	75	22	-	-	7	5.5	8	3	007	○
	P4	8.8	8.85	TCNS010N1A	1.5P	75	22	-	-	7	5.5	8	3	007	○

LONG

HAND TAPS

M10X1	P3	9	9.09	TCNR010M3A	3P	70	19	-	-	7	5.5	8	3	007	○
	P3	9	9.09	TCNR010M1A	1.5P	70	19	-	-	7	5.5	8	3	007	○
	P4	9	9.09	TCNS010M3A	3P	70	19	-	-	7	5.5	8	3	007	○
	P4	9	9.09	TCNS010M1A	1.5P	70	19	-	-	7	5.5	8	3	007	○

EG (STI)

M12X1.5	P3	10.5	10.6	TCNR01203A	3P	82	24	-	-	8.5	6.5	9	3	007	○
	P3	10.5	10.6	TCNR01201A	1.5P	82	24	-	-	8.5	6.5	9	3	007	○
	P4	10.5	10.6	TCNS01203A	3P	82	24	-	-	8.5	6.5	9	3	007	○
	P4	10.5	10.6	TCNS01201A	1.5P	82	24	-	-	8.5	6.5	9	3	007	○

SPECIAL THREADS, GAUGES

M12X1.25	P3	10.8	10.85	TCNR012N3A	3P	80	22	-	-	8.5	6.5	9	3	007	○
	P3	10.8	10.85	TCNR012N1A	1.5P	80	22	-	-	8.5	6.5	9	3	007	○
	P4	10.8	10.85	TCNS012N3A	3P	80	22	-	-	8.5	6.5	9	3	007	○
	P4	10.8	10.85	TCNS012N1A	1.5P	80	22	-	-	8.5	6.5	9	3	007	○

THREAD MILLS

M12X1	P3	11	11.09	TCNR012M3A	3P	70	19	-	-	8.5	6.5	9	3	007	○
	P3	11	11.09	TCNR012M1A	1.5P	70	19	-	-	8.5	6.5	9	3	007	○

DIES

M14X1.5	P3	12.5	12.6	TCNR01403A	3P	88	24	-	-	10.5	8	11	4	007	○
	P3	12.5	12.6	TCNR01401A	1.5P	88	24	-	-	10.5	8	11	4	007	○
	P4	12.5	12.6	TCNS01403A	3P	88	24	-	-	10.5	8	11	4	007	○
	P4	12.5	12.6	TCNS01401A	1.5P	88	24	-	-	10.5	8	11	4	007	○

CENTER DRILLS

M14X1.25	P3	12.8	12.85	TCNR014N3A	3P	88	22	-	-	10.5	8	11	4	007	○
	P3	12.8	12.85	TCNR014N1A	1.5P	88	22	-	-	10.5	8	11	4	007	○

Technical info

MF	TCTR (tolerance)	 Hole Ø (mm)	Hole Ø (mm)	Code	THCHT (chamfer)	LF (mm)	THL (mm)	LU (mm)	LS (mm)	DCON (mm)	K (mm)	LK (mm)	NOF	Type	Stock
JIS															
M14X1	P3	13	13.09	TCNR014M3A	3P	70	19	-	-	10.5	8	11	4	007	○
	P3	13	13.09	TCNR014M1A	1.5P	70	19	-	-	10.5	8	11	4	007	○
	P4	13	13.09	TCNS014M3A	3P	70	19	-	-	10.5	8	11	4	007	○
	P4	13	13.09	TCNS014M1A	1.5P	70	19	-	-	10.5	8	11	4	007	○
M16X1.5	P3	14.5	14.6	TCNR01603A	3P	95	24	-	-	12.5	10	13	4	007	○
	P3	14.5	14.6	TCNR01601A	1.5P	95	24	-	-	12.5	10	13	4	007	○
	P4	14.5	14.6	TCNS01603A	3P	95	24	-	-	12.5	10	13	4	007	○
	P4	14.5	14.6	TCNS01601A	1.5P	95	24	-	-	12.5	10	13	4	007	○
M16X1	P3	15	15.09	TCNR016M3A	3P	75	19	-	-	12.5	10	13	4	007	○
	P3	15	15.09	TCNR016M1A	1.5P	75	19	-	-	12.5	10	13	4	007	○
M18X1.5	P4	16.5	16.6	TCNS01803A	3P	95	24	-	-	14	11	14	4	007	○
	P4	16.5	16.6	TCNS01801A	1.5P	95	24	-	-	14	11	14	4	007	○
M20X1.5	P4	18.5	18.6	TCNS02003A	3P	95	24	-	-	15	12	15	4	007	○
	P4	18.5	18.6	TCNS02001A	1.5P	95	24	-	-	15	12	15	4	007	○

Intro

SP

SL

PO

ST

ROLL

CARBIDE

JIS

LONG

HAND
TAPS

EG (STI)

SPECIAL
THREADS,
GAUGESTHREAD
MILLS

DIES

CENTER
DRILLSTechnical
info

Intro

MC-AD-CT



MS Material Specific Series

SP Carbide Taps with Axial Coolant Hole, Coated



FEATURES

Carbide taps with axial oil hole and 1.5P chamfer for blind hole application.

For mass production on aluminium die-cast parts such as cylinder blockhead, transmission case and manifold water-pump.

Suitable coating for long life even at higher speed.

SL

PO Recommended Tapping Speeds Depending On Materials

ISO	Vc (m/min)
N1	30÷60 ★
N2	30÷60 ★
N4	30÷60 ★

★ 1st choice ☆ suitable

ST

ROLL

CARBIDE

JIS

LONG

HAND TAPS

Process Data

Part name	Cylinder block
Material	G-AISI6Cu4
Size	M6x1
Hole shape	Blind
Hole depth	14 mm
Thread length	12 mm
Machine	MC
Direction	Horizontal
Feed	Synchronized feed
Tapping speed	57 m/min
Lubricant	Water soluble oil
Tool life	240.000 holes



EG (STI)

SPECIAL THREADS, GAUGES

THREAD MILLS

DIES

CENTER DRILLS

Technical info

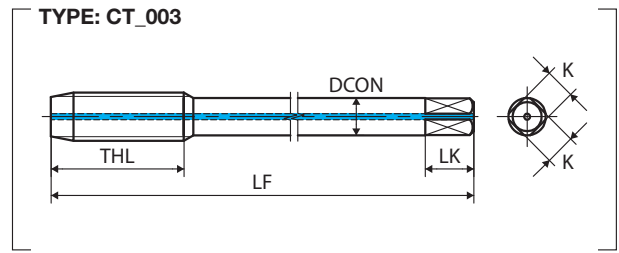
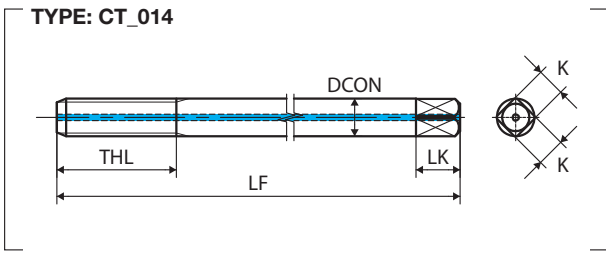

M	TCTR (tolerance)	\varnothing (mm)	Hole \varnothing (mm)	Code	THCHT (chamfer)	LF (mm)	THL (mm)	LU (mm)	LS (mm)	DCON (mm)	K (mm)	LK (mm)	NOF	Type	Stock
JIS															
M6X1	P3	5	5.09	MCADR6.0M1	1.5P	100	19	-	-	6	4.5	7	3	014	○
M8X1.25	P3	6.8	6.85	MCADR8.0N1	1.5P	100	22	-	-	6.2	5	8	3	003	○
M10X1.5	P4	8.5	8.6	MCADS01001	1.5P	100	24	-	-	7	5.5	8	3	003	○
M12X1.75	P4	10.3	10.36	MCADS012P1	1.5P	100	30	-	-	8.5	6.5	9	3	003	○
MF	TCTR (tolerance)	\varnothing (mm)	Hole \varnothing (mm)	Code	THCHT (chamfer)	LF (mm)	THL (mm)	LU (mm)	LS (mm)	DCON (mm)	K (mm)	LK (mm)	NOF	Type	Stock
JIS															
M10X1.25	P4	8.8	8.85	MCADS010N1	1.5P	100	22	-	-	7	5.5	8	3	003	○
M10X1	P4	9	9.09	MCADS010M1	1.5P	100	19	-	-	7	5.5	8	3	003	○
M12X1.5	P4	10.5	10.6	MCADS01201	1.5P	100	24	-	-	8.5	6.5	9	3	003	○
M12X1.25	P4	10.8	10.85	MCADS012N1	1.5P	100	22	-	-	8.5	6.5	9	3	003	○

- Intro
- SP
- SL
- PO
- ST
- ROLL
- CARBIDE
- JIS
- LONG
- HAND TAPS
- EG (STI)
- SPECIAL THREADS, GAUGES
- THREAD MILLS
- DIES
- CENTER DRILLS
- Technical info

Intro

ACHSP



MS Material Specific Series

Carbide Taps Spiral Fluted with Axial Coolant Hole for Cored Holes in Aluminium, Coated



Recommended Tapping Speeds Depending On Materials

ISO	Vc (m/min)
N2	30÷50 ★

★ 1st choice ☆ suitable

FEATURES

Material Specific Carbide tap Series for Aluminium tapping.

For tapping irregular cored holes thanks to the frontal cutting edge.

Ideal for tapping cored holes in a variety of Aluminium components like: Engine Block, Cylinder Head, Transmission Case, Manifold, Water Pump, etc.



WATCH THE VIDEO

ST

ROLL

Process Data

Reinforced shank diameter improves rigidity, deflection resistance, and side pressure caused by misalignment. Max allowed misalignment: M6, M8 = 0.3mm - M10 = 0.5mm

CARBIDE

JIS

LONG

HAND TAPS

Thread size	M8x1.25	
Work-material	G-ALSi12	
Cutting Speed	50 m/min	
Hole condition	Minimum diameter size	ø5.8 mm
	Taper angle	2°
	Tapping depth	22 mm
	Hole type	Blind
Internal thread length	17 mm	
Misalignment	+0.5 mm	
Feed	Synchronous	
Machine	M/C (horizontal)	
Lubricant	Water soluble oil	

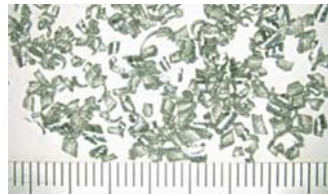

EG (STI)

SPECIAL THREADS, GAUGES

THREAD MILLS

DIES

CENTER DRILLS

Technical info

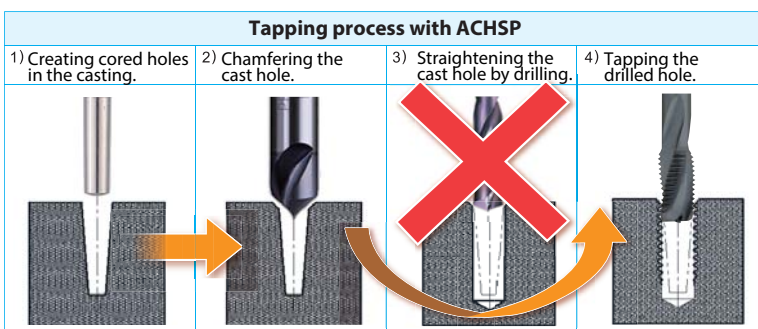
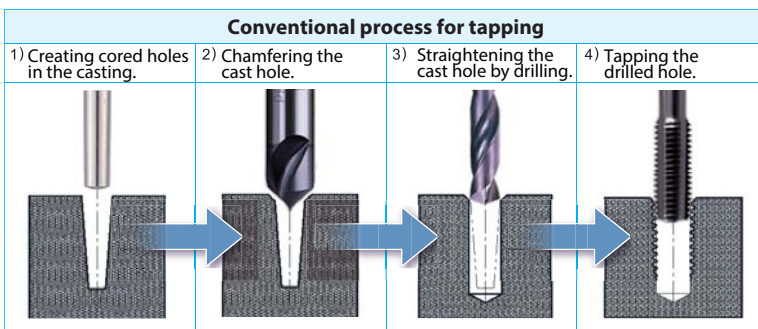

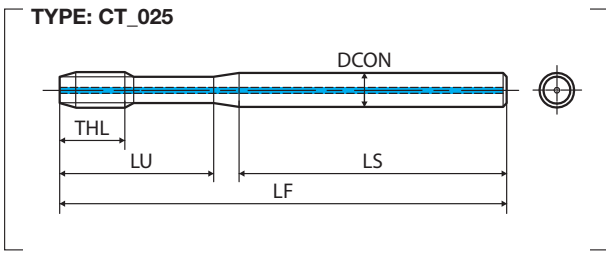

M	TCTR (tolerance)	\varnothing (mm)	Hole \varnothing (mm)	Code	THCHT (chamfer)	LF (mm)	THL (mm)	LU (mm)	LS (mm)	DCON (mm)	K (mm)	LK (mm)	NOF	Type	Stock
JIS															
M6X1	P3	5	5.09	SY6.0MRLXT	2.5P	80	12	27	48	6	-	-	3	025	○
M8X1.25	P4	6.8	6.85	SY8.0NSLXT	2.5P	90	15	30	54	8	-	-	3	025	○
M10X1.5	P4	8.5	8.6	SY0100SLXT	2.5P	100	18	36	57	10	-	-	3	025	○
MF	TCTR (tolerance)	\varnothing (mm)	Hole \varnothing (mm)	Code	THCHT (chamfer)	LF (mm)	THL (mm)	LU (mm)	LS (mm)	DCON (mm)	K (mm)	LK (mm)	NOF	Type	Stock
JIS															
M10X1.25	P4	8.8	8.85	SY010NSLXT	2.5P	100	18	36	57	10	-	-	3	025	○

Intro

SP

SL

PO

ST

ROLL

CARBIDE

JIS

LONG

HAND
TAPS

EG (STI)

SPECIAL
THREADS,
GAUGES

THREAD
MILLS

DIES

CENTER
DRILLS

Technical
info

Intro

HFICT-B



HS High Speed Series

Carbide Taps with Axial Coolant Hole for Cast Iron Ultra Fast Tapping, Coated



FEATURES

Carbide Ultra High Speed taps with axial oil hole for blind hole application.

Specific design, ultra fine micrograin, suitable coating for long and stable tool life on Cast Iron application.

For Synchro-rigid tapping system.

SP

SL

PO

Recommended Tapping Speeds Depending On Materials

ISO Vc (m/min)

K1 25÷50 ★

K2 25÷50 ★

ST

★ 1st choice ☆ suitable

ROLL

CARBIDE

JIS

LONG

HAND TAPS

EG (STI)

SPECIAL THREADS, GAUGES

THREAD MILLS

DIES

CENTER DRILLS

Technical info

TYPE: CT_017

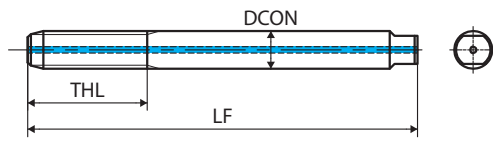

TYPE: CT_024

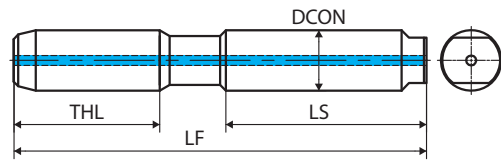

M	TCTR (tolerance)	Hole Ø (mm)	Hole Ø (mm)	Code	THCHT (chamfer)	LF (mm)	THL (mm)	LU (mm)	LS (mm)	DCON (mm)	K (mm)	LK (mm)	NOF	Type	Stock
JIS															
M6X1	P3	5	5.09	HFICTBR6.0M	2.5P	62	19	-	-	6	-	-	4	017	○
M8X1.25	P3	6.8	6.85	HFICTBR8.0N	2.5P	70	22	-	36	8	-	-	4	024	○
M10X1.5	P3	8.5	8.6	HFICTBR0100	2.5P	75	24	-	37	10	-	-	4	024	○
M12X1.75	P3	10.3	10.36	HFICTBR012P	2.5P	82	29	-	40	12	-	-	4	024	○
MF															
JIS															
M10X1.25	P3	8.8	8.85	HFICTBR010N	2.5P	75	24	-	37	10	-	-	4	024	○
M12X1.5	P3	10.5	10.6	HFICTBR0120	2.5P	82	29	-	40	12	-	-	4	024	○
M12X1.25	P3	10.8	10.85	HFICTBR012N	2.5P	82	29	-	40	12	-	-	4	024	○

HFICT-P

HS High Speed Series

Carbide Taps with Radial Coolant Holes for Cast Iron Ultra Fast Tapping, Coated



FEATURES

Carbide Ultra High Speed taps with radial oil holes for through hole application.

Specific design, ultra fine micrograin, suitable coating for long and stable tool life on Cast Iron application.

For Synchro-rigid tapping system.

Recommended Tapping Speeds Depending On Materials

ISO Vc (m/min)

K1 25÷50 ★

K2 25÷50 ★

★ 1st choice ☆ suitable

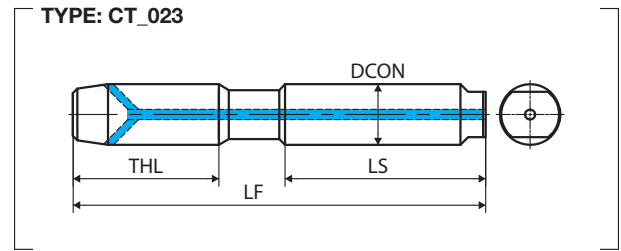
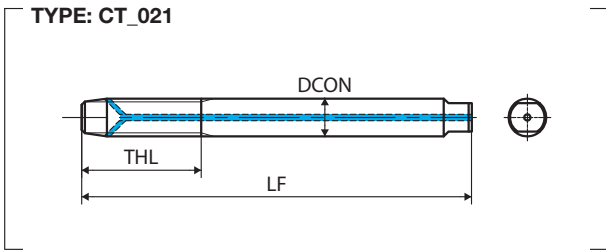

M	TCTR (tolerance)	Hole Ø (mm)	Hole Ø (mm)	Code	THCHT (chamfer)	LF (mm)	THL (mm)	LU (mm)	LS (mm)	DCON (mm)	K (mm)	LK (mm)	NOF	Type	Stock
JIS															
M6X1	P3	5	5.09	HFICTPR6.0M	4P	62	19	-	-	6	-	-	4	021	○
M8X1.25	P3	6.8	6.85	HFICTPR8.0M	4P	70	22	-	36	8	-	-	4	023	○
M10X1.5	P3	8.5	8.6	HFICTPR0100	4P	75	24	-	37	10	-	-	4	023	○
M12X1.75	P3	10.3	10.36	HFICTPR012P	4P	82	29	-	40	12	-	-	4	023	○
MF	TCTR (tolerance)	Hole Ø (mm)	Hole Ø (mm)	Code	THCHT (chamfer)	LF (mm)	THL (mm)	LU (mm)	LS (mm)	DCON (mm)	K (mm)	LK (mm)	NOF	Type	Stock
JIS															
M10X1.25	P3	8.8	8.85	HFICTPR010N	4P	75	24	-	37	10	-	-	4	023	○
M12X1.5	P3	10.5	10.6	HFICTPR0120	4P	82	29	-	40	12	-	-	4	023	○
M12X1.25	P3	10.8	10.85	HFICTPR012N	4P	82	29	-	40	12	-	-	4	023	○

- Intro
- SP
- SL
- PO
- ST
- ROLL
- CARBIDE
- JIS
- LONG
- HAND TAPS
- EG (STI)
- SPECIAL THREADS, GAUGES
- THREAD MILLS
- DIES
- CENTER DRILLS
- Technical info

Intro

HFACT-B

HS High Speed Series

Carbide Taps with Axial Coolant Hole for Non-Ferrous Materials Ultra Fast Tapping, Coated



SP

SL

PO

ST

ROLL

CARBIDE

JIS

LONG

HAND TAPS

EG (STI)

SPECIAL THREADS, GAUGES

THREAD MILLS

DIES

CENTER DRILLS

Technical info



Recommended Tapping Speeds Depending On Materials

ISO Vc (m/min)

N1	30÷100	★
N2	30÷100	★
N4	30÷100	★

★ 1st choice ☆ suitable

FEATURES

Carbide Ultra High Speed taps with axial oil hole for blind hole application.

Specific design, ultra fine micrograin, suitable coating for long and stable tool life on Aluminium casting and Aluminium die-casting.

For Synchro-rigid tapping system.

TYPE: CT_017

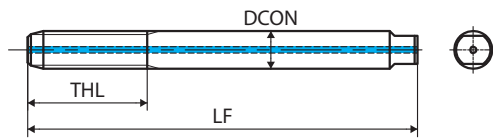

TYPE: CT_024

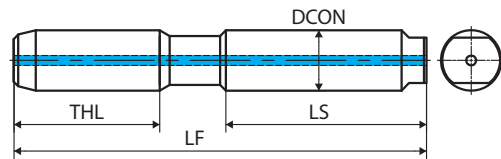

M	TCTR (tolerance)	 (mm)	Hole \varnothing (mm)	Code	THCHT (chamfer)	LF (mm)	THL (mm)	LU (mm)	LS (mm)	DCON (mm)	K (mm)	LK (mm)	NOF	Type	Stock
JIS															
M6X1	P3	5	5.09	HFACTBR6.0M	2.5P	62	19	-	-	6	-	-	3	017	○
M8X1.25	P3	6.8	6.85	HFACTBR8.0N	2.5P	70	22	-	36	8	-	-	3	024	○
M10X1.5	P3	8.5	8.6	HFACTBR0100	2.5P	75	24	-	37	10	-	-	3	024	○
M12X1.75	P3	10.3	10.36	HFACTBR012P	2.5P	82	29	-	40	12	-	-	3	024	○
MF															
JIS															
M10X1.25	P3	8.8	8.85	HFACTBR010N	2.5P	75	24	-	37	10	-	-	3	024	○
M12X1.5	P3	10.5	10.6	HFACTBR0120	2.5P	82	29	-	40	12	-	-	3	024	○
M12X1.25	P3	10.8	10.85	HFACTBR012N	2.5P	82	29	-	40	12	-	-	3	024	○

HFACT-P

HS High Speed Series

Carbide Taps with Radial Coolant Holes for Non-Ferrous Materials Ultra Fast Tapping, Coated



FEATURES

Carbide Ultra High Speed taps with radial oil holes for through hole application.

Specific design, ultra fine micrograin, suitable coating for long and stable tool life on Aluminium casting and Aluminium die-casting.

For Synchro-rigid tapping system.

Recommended Tapping Speeds Depending On Materials

ISO Vc (m/min)

N1 30÷100 ★

N2 30÷100 ★

N4 30÷100 ★

★ 1st choice ☆ suitable

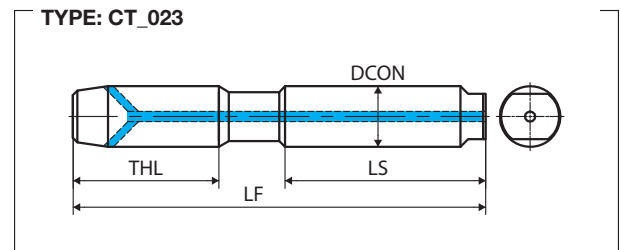
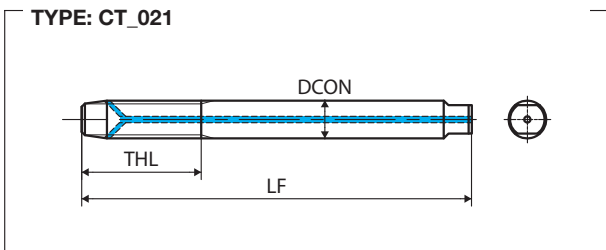

M	TCTR (tolerance)	Hole Ø (mm)	Hole Ø (mm)	Code	THCHT (chamfer)	LF (mm)	THL (mm)	LU (mm)	LS (mm)	DCON (mm)	K (mm)	LK (mm)	NOF	Type	Stock
JIS															
M6X1	P3	5	5.09	HFACTPR6.0M	4P	62	19	-	-	6	-	-	3	021	○
M8X1.25	P3	6.8	6.85	HFACTPR8.0N	4P	70	22	-	36	8	-	-	3	023	○
M10X1.5	P3	8.5	8.6	HFACTPR0100	4P	75	24	-	37	10	-	-	3	023	○
M12X1.75	P3	10.3	10.36	HFACTPR012P	4P	82	29	-	40	12	-	-	3	023	○
MF	TCTR (tolerance)	Hole Ø (mm)	Hole Ø (mm)	Code	THCHT (chamfer)	LF (mm)	THL (mm)	LU (mm)	LS (mm)	DCON (mm)	K (mm)	LK (mm)	NOF	Type	Stock
JIS															
M10X1.25	P3	8.8	8.85	HFACTPR010N	4P	75	24	-	37	10	-	-	3	023	○
M12X1.5	P3	10.5	10.6	HFACTPR0120	4P	82	29	-	40	12	-	-	3	023	○
M12X1.25	P3	10.8	10.85	HFACTPR012N	4P	82	29	-	40	12	-	-	3	023	○

- Intro
- SP
- SL
- PO
- ST
- ROLL
- CARBIDE
- JIS
- LONG
- HAND TAPS
- EG (STI)
- SPECIAL THREADS, GAUGES
- THREAD MILLS
- DIES
- CENTER DRILLS
- Technical info

MEMO



A large section of the page containing multiple horizontal dashed lines for writing. The lines are evenly spaced and cover most of the page's width and height.

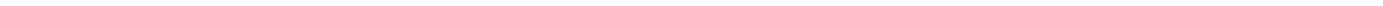

LONG TAPS



LONG - JIS 432

Selection Chart

Intro

SP

SL

PO

ST

ROLL

CARBIDE

LONG

HAND TAPS

EG (STI)

















SPECIAL THREADS, GAUGES

THREAD MILLS

















DIES

CENTER DRILLS

Technical info

		GP General Purpose					MS Material Specific		
		LS-SP	LS-SP-PF	LS-SP-K	LS-SP LH	LS-SP V	MC-SP	LS-PM-SP	LS-SU-S-SP
		HSS-E	HSS-E	HSS-E	HSS-E	HSS-E COATING	HSS-E	HSS-P	HSS-E OX
									
									
									
		JIS	JIS	JIS	JIS	JIS	JIS	JIS	JIS
M		433		439	440	441	442	445	447
MF		434			440	441	443	445	447
UNC/UNF		435							
UNS, 8, 12, 20, 32UN									
UNEF									
G (BSP)			438						
Rp (BSPP)									
Rc (BSPT)									
NPT									
NPTF									
NPSC, NPSM, NPSF									
BSW		436							
EG(STI), M, MF, UNC/UNF									
Pg									
Tr									
S miniature									
Special threads									
		Vc (m/min)							
P1		☆ 5÷10	☆ 5÷10	☆ 5÷10	☆ 5÷10	★ 10÷20	☆ 5÷10		
P2		★ 5÷10	★ 5÷10	★ 5÷10	★ 5÷10	★ 10÷20	★ 5÷10		★ ≤10
P3		☆ 5÷10	☆ 5÷10	☆ 5÷10	☆ 5÷10	★ 10÷20	☆ 5÷10	☆ 2÷10	★ ≤10
P4		☆ 5÷8	☆ 5÷10	☆ 5÷8	☆ 5÷8	★ 10÷15	☆ 5÷8	★ 2÷7	☆ ≤10
P5								★ 2÷7	
P6								★ 2÷5	
P7						☆ 6÷12			★ ≤10
P8									
M1						☆ 6÷12			★ ≤10
M2									
M3									
K1									
K2									
K3									
K4									
N1		☆ 5÷10	☆ 5÷10	☆ 5÷10	☆ 5÷10	☆ 10÷20	☆ 5÷10		
N2		☆ 5÷10	☆ 5÷10	☆ 5÷10	☆ 5÷10	☆ 10÷20	☆ 5÷10		
N3		☆ 5÷10	☆ 5÷10	☆ 5÷10	☆ 5÷10	☆ 10÷20	☆ 5÷10		
N4		☆ 5÷10	☆ 5÷10	☆ 5÷10	☆ 5÷10	☆ 10÷20	☆ 5÷10		
N5									
S1 (<25 HRC)									
S2 (<35 HRC)									
S3 (35 ÷ 45 HRC)									
S5									
H (45 ÷ 55 HRC)									
H (55 ÷ 63 HRC)									

★ 1st choice ☆ suitable

GP General Purpose				MS Material Specific	GP General Purpose				
LS-PO	LS-PO-K	LS-PO V		MC-PO	LS-PM-PO	LS-SU-S-PO		LS-HT	LS-PF
HSS-E	HSS-E	HSS-E	COATING	HSS-E	HSS-P	HSS-E	OX	HSS-E	HSS-E
									
									
JIS	JIS	JIS		JIS	JIS	JIS		JIS	JIS
449	454	455		456	459	461		463	
450		455		457	459	461		467	
451								471	
									474
									G (BSP)
									Rp (BSPP)
									Rc (BSPT)
									NPT
									NPTF
									NPSC, NPSM, NPSF
452								473	BSW
									EG(STI), M, MF, UNC/UNF
									Pg
									Tr
									S miniature
									Special threads
Vc (m/min)									
☆ 5÷10	☆ 5÷10	★ 10÷20	☆ 5÷10		★ ≤10	☆ 5÷10	☆ 5÷10		P1
★ 5÷10	★ 5÷10	★ 10÷20	★ 5÷10		★ ≤10	★ 5÷10	★ 5÷10		P2
☆ 5÷10	☆ 5÷10	★ 10÷20	☆ 5÷10	★ 2÷10	★ ≤10	☆ 5÷10	☆ 5÷10		P3
☆ 5÷8	☆ 5÷8	★ 10÷15	☆ 5÷8	★ 2÷7	☆ ≤10	☆ 5÷10	☆ 5÷10		P4
				★ 2÷7					P5
				★ 2÷5					P6
		☆ 6÷12			★ ≤10				P7
									P8
		☆ 6÷12			★ ≤10				M1
		☆ 5÷10			★ ≤10				M2
									M3
						☆ 5÷10	☆ 5÷10		K1
						☆ 5÷10	☆ 5÷10		K2
						☆ 5÷10	☆ 5÷10		K3
									K4
☆ 5÷10	☆ 5÷10	☆ 10÷20	☆ 5÷10						N1
☆ 5÷10	☆ 5÷10	☆ 10÷20	☆ 5÷10			☆ 5÷10	☆ 5÷10		N2
☆ 5÷10	☆ 5÷10	☆ 10÷20	☆ 5÷10			☆ 5÷10	☆ 5÷10		N3
☆ 5÷10	☆ 5÷10	☆ 10÷20	☆ 5÷10			☆ 5÷10	☆ 5÷10		N4
									N5
									S1 (<25 HRC)
									S2 (<35 HRC)
									S3 (35 ÷ 45 HRC)
									S5
									H (45 ÷ 55 HRC)
									H (55 ÷ 63 HRC)

Intro

SP

SL

PO

ST

ROLL

CARBIDE

LONG

HAND TAPS

EG (STI)

SPECIAL THREADS, GAUGES

THREAD MILLS

DIES

CENTER DRILLS

Technical info

Selection Chart

Intro

SP

SL

PO

ST

ROLL

CARBIDE

LONG

HAND TAPS

EG (STI)











SPECIAL THREADS, GAUGES

THREAD MILLS

DIES

CENTER DRILLS

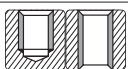
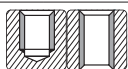
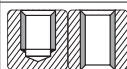
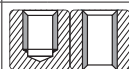
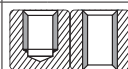
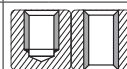
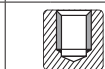
Technical info

		GP General Purpose							
		LS-PS	LS-PT	LS-NPT	LS-NPTF	LS-HT LH	LS-HT V	MC-HT	LS-N-RZ
		HSS-E	HSS-E	HSS-E	HSS-E	HSS-E	HSS-E COATING	HSS-E	HSS-E OX
									
									
		JIS							
M						481	485	487	491
MF						482	485	488	491
UNC/UNF									
UNS, 8, 12, 20, 32UN									
UNEF									
G (BSP)									
Rp (BSPP)		475							
Rc (BSPT)			477						
NPT				478					
NPTF					479				
NPSC, NPSM, NPSF									
BSW									
EG(STI), M, MF, UNC/UNF									
Pg									
Tr									
S miniature									
Special threads									
		Vc (m/min)							
P1		☆ 5÷10	☆ ≤5	☆ ≤5	☆ ≤5	☆ 5÷10		☆ 5÷10	★ 5÷15
P2		★ 5÷10	★ ≤5	★ ≤5	★ ≤5	★ 5÷10	★ 10÷20	★ 5÷10	★ 5÷10
P3		☆ 5÷10	☆ ≤5	☆ ≤5	☆ ≤5	☆ 5÷10	★ 10÷20	☆ 5÷10	
P4		☆ 5÷10	☆ ≤5	☆ ≤5	☆ ≤5	☆ 5÷10	☆ 8÷15	☆ 5÷10	
P5									
P6									
P7									
P8									
M1									
M2									
M3									
K1		☆ 5÷10	☆ ≤5	☆ ≤5	☆ ≤5	☆ 5÷10	☆ 8÷15	☆ 5÷10	
K2		☆ 5÷10	☆ ≤5	☆ ≤5	☆ ≤5	☆ 5÷10	☆ 8÷15	☆ 5÷10	
K3				☆ ≤5	☆ ≤5	☆ 5÷10	☆ 8÷15	☆ 5÷10	
K4									
N1									
N2		☆ 5÷10	☆ ≤5	☆ ≤5	☆ ≤5	☆ 5÷10	☆ 10÷20	☆ 5÷10	
N3		☆ 5÷10	☆ ≤5	☆ ≤5	☆ ≤5	☆ 5÷10	☆ 10÷20	☆ 5÷10	
N4		☆ 5÷10	☆ ≤5	☆ ≤5	☆ ≤5	☆ 5÷10	☆ 10÷20	☆ 5÷10	
N5									
S1 (<25 HRC)									
S2 (<35 HRC)									
S3 (35 ÷ 45 HRC)									
S5									
H (45 ÷ 55 HRC)									
H (55 ÷ 63 HRC)									

★ 1st choice ☆ suitable



GP General Purpose	
LS-N-RS	
HSS-E	NI
JIS	
493	M
493	MF
	UNC/UNF
	UNS, 8, 12, 20, 32UN
	UNEF
	G (BSP)
	Rp (BSPP)
	Rc (BSPT)
	NPT
	NPTF
	NPSC, NPSM, NPSF
	BSW
	EG(STI), M, MF, UNC/UNF
	Pg
	Tr
	S miniature
	Special threads
Vc (m/min)	
	P1
	P2
	P3
	P4
	P5
	P6
	P7
	P8
	M1
	M2
	M3
	K1
	K2
	K3
	K4
★	5÷15 N1
★	5÷15 N2
★	5÷15 N3
	N4
	N5
	S1 (<35 HRC)
	S2 (<35 HRC)
	S3 (35 ÷ 45 HRC)
	S5
	H (45 ÷ 55 HRC)
	H (55 ÷ 63 HRC)

- Intro
- SP
- SL
- PO
- ST
- ROLL
- CARBIDE
- LONG**
- HAND TAPS
- EG (STI)
- SPECIAL THREADS, GAUGES
- THREAD MILLS
- DIES
- CENTER DRILLS
- Technical info

Intro

LS-SP

GP General Purpose Series

SP

Long Shank Spiral Fluted Taps

SL



PO

Recommended Tapping Speeds Depending On Materials

ISO	Vc (m/min)	ISO	Vc (m/min)
P1	5÷10 ☆	N1	5÷10 ☆
P2	5÷10 ★	N2	5÷10 ☆
P3	5÷10 ☆	N3	5÷10 ☆
P4	5÷8 ☆	N4	5÷10 ☆

★ 1st choice ☆ suitable

ROLL

CARBIDE

LONG

JIS

HAND TAPS

EG (STI)

SPECIAL THREADS, GAUGES

THREAD MILLS

DIES

CENTER DRILLS

Technical info



FEATURES

Long shank general purpose for extended overhang on blind hole application.

For steel application at medium-low cutting speed, also suitable for non-ferrous materials.

TYPE: SP_005

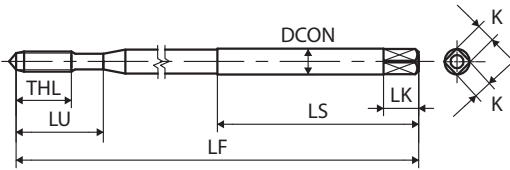

TYPE: SP_008

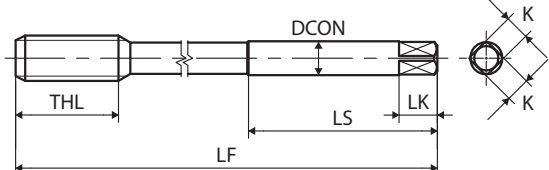

Oversized
Old Code
New Code

● stock standard, ● check stock EU, ○ check stock JP, ▽ stock exhaustion

M	TCTR (tolerance)	∅ (mm)	Hole ∅ (mm)	Code	THCHT (chamfer)	LF (mm)	THL (mm)	LU (mm)	LS (mm)	DCON (mm)	K (mm)	LK (mm)	NOF	Type	Stock
JIS															
M2X0.4	P1	1.6	1.65	SPFP2.0EL07	2.5P	70	7.2	15	52	3	2.5	5	2	005	○
M2.3X0.4	P1	1.9	1.95	SPFP2.3EL07	2.5P	70	7.2	15	52	3	2.5	5	2	005	○
M2.5X0.45	P1	2.1	2.11	SPFP2.5FL07	2.5P	70	8.1	15	52	3	2.5	5	2	005	○
M2.6X0.45	P1	2.2	2.21	SPFP2.6FL07	2.5P	70	8.1	15	52	3	2.5	5	2	005	○
M3X0.5	P1	2.5	2.56	SPFP3.0GL07	2.5P	70	9	18	46	4	3.2	6	3	005	○
	P1	2.5	2.56	SPP3.0GL10	2.5P	100	9	14	40	4	3.2	6	3	005	▽
	P1	2.5	2.56	SPFP3.0GL10	2.5P	100	9	18	40	4	3.2	6	3	005	●
	P1	2.5	2.56	SPFP3.0GL12	2.5P	120	9	18	40	4	3.2	6	3	005	○
	P1	2.5	2.56	SPFP3.0GL15	2.5P	150	9	18	40	4	3.2	6	3	005	○
	P2(P1+15)	2.5	2.56	SPFQ3.0GL10	2.5P	100	9	18	40	4	3.2	6	3	005	○
	P2(P1+15)	2.5	2.56	SPFQ3.0GL15	2.5P	150	9	18	40	4	3.2	6	3	005	○
	P3(P1+30)	2.5	2.56	SPFR3.0GL10	2.5P	100	9	18	40	4	3.2	6	3	005	○
P3(P1+30)	2.5	2.56	SPFR3.0GL15	2.5P	150	9	18	40	4	3.2	6	3	005	○	
M4X0.7	P2	3.3	3.38	SPFQ4.0IL07	2.5P	70	11	21	43	5	4	7	3	005	○
	P2	3.3	3.38	SPQ4.0IL10	2.5P	100	11	17	40	5	4	7	3	005	▽
	P2	3.3	3.38	SPFQ4.0IL10	2.5P	100	11	21	40	5	4	7	3	005	●
	P2	3.3	3.38	SPFQ4.0IL12	2.5P	120	11	21	40	5	4	7	3	005	○
	P2	3.3	3.38	SPQ4.0IL15	2.5P	150	11	17	40	5	4	7	3	005	▽
	P2	3.3	3.38	SPFQ4.0IL15	2.5P	150	11	21	40	5	4	7	3	005	●
	P3(P2+20)	3.3	3.38	SPFR4.0IL10	2.5P	100	11	21	40	5	4	7	3	005	○
P3(P2+20)	3.3	3.38	SPFR4.0IL15	2.5P	150	11	21	40	5	4	7	3	005	○	
M5X0.8	P2	4.2	4.28	SPQ5.0KL10	2.5P	100	13	22	40	5.5	4.5	7	3	005	▽
	P2	4.2	4.28	SPFQ5.0KL10	2.5P	100	13	25	40	5.5	4.5	7	3	005	●
	P2	4.2	4.28	SPFQ5.0KL12	2.5P	120	13	25	40	5.5	4.5	7	3	005	○
	P2	4.2	4.28	SPQ5.0KL15	2.5P	150	13	22	40	5.5	4.5	7	3	005	▽
	P2	4.2	4.28	SPFQ5.0KL15	2.5P	150	13	25	40	5.5	4.5	7	3	005	●
	P3(P2+20)	4.2	4.28	SPFR5.0KL10	2.5P	100	13	25	40	5.5	4.5	7	3	005	○
P3(P2+20)	4.2	4.28	SPFR5.0KL15	2.5P	150	13	25	40	5.5	4.5	7	3	005	○	
M6X1	P2	5	5.09	SPQ6.0ML10	2.5P	100	15	26	40	6	4.5	7	3	005	▽
	P2	5	5.09	SPFQ6.0ML10	2.5P	100	15	30	40	6	4.5	7	3	005	●
	P2	5	5.09	SPFQ6.0ML12	2.5P	120	15	30	40	6	4.5	7	3	005	○
	P2	5	5.09	SPQ6.0ML15	2.5P	150	15	26	40	6	4.5	7	3	005	▽
	P2	5	5.09	SPFQ6.0ML15	2.5P	150	15	30	40	6	4.5	7	3	005	●
	P3(P2+20)	5	5.09	SPFR6.0ML10	2.5P	100	15	30	40	6	4.5	7	3	005	○
P3(P2+20)	5	5.09	SPFR6.0ML15	2.5P	150	15	30	40	6	4.5	7	3	005	○	
M8X1.25	P2	6.8	6.85	SPQ8.0NL10	2.5P	100	19	-	50	6.2	5	8	3	008	●
	P2	6.8	6.85	SPQ8.0NL12	2.5P	120	19	-	50	6.2	5	8	3	008	○
	P2	6.8	6.85	SPQ8.0NL15	2.5P	150	19	-	50	6.2	5	8	3	008	●
	P2	6.8	6.85	SPQ8.0NL20	2.5P	200	19	-	50	6.2	5	8	3	008	○
	P3(P2+20)	6.8	6.85	SPR8.0NL10	2.5P	100	19	-	50	6.2	5	8	3	008	○
P3(P2+20)	6.8	6.85	SPR8.0NL15	2.5P	150	19	-	50	6.2	5	8	3	008	○	

Intro

SP

SL

PO

ST

ROLL

CARBIDE

LONG

JIS

HAND TAPS

EG (STI)

SPECIAL THREADS, GAUGES

THREAD MILLS

DIES

CENTER DRILLS

Technical info

Long Taps

Intro

SP

SL

PO

ST

ROLL

CARBIDE

LONG

JIS

HAND
TAPS

EG (STI)

SPECIAL
THREADS,
GAUGES



THREAD
MILLS

DIES

CENTER
DRILLS

Technical
info

M	TCTR (tolerance)	\varnothing (mm)	Hole \varnothing (mm)	Code	THCHT (chamfer)	LF (mm)	THL (mm)	LU (mm)	LS (mm)	DCON (mm)	K (mm)	LK (mm)	NOF	Type	Stock	
JIS																
M10X1.5	P2	8.5	8.6	SPQ0100L10	2.5P	100	23	-	50	7	5.5	8	3	008	○	
	P2	8.5	8.6	SPQ0100L12	2.5P	120	23	-	50	7	5.5	8	3	008	○	
	P2	8.5	8.6	SPQ0100L15	2.5P	150	23	-	50	7	5.5	8	3	008	●	
	P2	8.5	8.6	SPQ0100L20	2.5P	200	23	-	50	7	5.5	8	3	008	●	
	P3(P2+20)	8.5	8.6	SPR0100L10	2.5P	100	23	-	50	7	5.5	8	3	008	○	
	P3(P2+20)	8.5	8.6	SPR0100L15	2.5P	150	23	-	50	7	5.5	8	3	008	○	
M12X1.75	P2	10.3	10.36	SPQ012PL10	2.5P	100	26	-	50	8.5	6.5	9	3	008	○	
	P2	10.3	10.36	SPQ012PL12	2.5P	120	26	-	50	8.5	6.5	9	3	008	○	
	P2	10.3	10.36	SPQ012PL15	2.5P	150	26	-	50	8.5	6.5	9	3	008	●	
	P2	10.3	10.36	SPQ012PL20	2.5P	200	26	-	50	8.5	6.5	9	3	008	●	
	P3(P2+20)	10.3	10.36	SPR012PL15	2.5P	150	26	-	50	8.5	6.5	9	3	008	○	
M14X2	P2	12	12.12	SPQ014QL12	2.5P	120	26	-	60	10.5	8	11	3	008	○	
	P2	12	12.12	SPQ014QL15	2.5P	150	26	-	60	10.5	8	11	3	008	●	
	P2	12	12.12	SPQ014QL20	2.5P	200	26	-	60	10.5	8	11	3	008	○	
M16X2	P2	14	14.12	SPQ016QL15	2.5P	150	26	-	60	12.5	10	13	3	008	●	
	P2	14	14.12	SPQ016QL20	2.5P	200	26	-	60	12.5	10	13	3	008	●	
	P2	14	14.12	SPQ016QL25	2.5P	250	26	-	60	12.5	10	13	3	008	○	
M18X2.5	P3	15.5	15.63	SPR018RL15	2.5P	150	33	-	70	14	11	14	4	008	○	
	P3	15.5	15.63	SPR018RL20	2.5P	200	33	-	70	14	11	14	4	008	○	
	P3	15.5	15.63	SPR018RL25	2.5P	250	33	-	70	14	11	14	4	008	○	
M20X2.5	P3	17.5	17.63	SPR020RL15	2.5P	150	33	-	70	15	12	15	4	008	○	
	P3	17.5	17.63	SPR020RL20	2.5P	200	33	-	70	15	12	15	4	008	●	
	P3	17.5	17.63	SPR020RL25	2.5P	250	33	-	70	15	12	15	4	008	○	
M22X2.5	P3	19.5	19.63	SPR022RL15	2.5P	150	33	-	70	17	13	16	4	008	○	
	P3	19.5	19.63	SPR022RL20	2.5P	200	33	-	70	17	13	16	4	008	○	
	P3	19.5	19.63	SPR022RL25	2.5P	250	33	-	70	17	13	16	4	008	○	
M24X3	P3	21	21.13	SPR024SL15	2.5P	150	39	-	80	19	15	18	4	008	○	
	P3	21	21.13	SPR024SL20	2.5P	200	39	-	80	19	15	18	4	008	●	
	P3	21	21.13	SPR024SL25	2.5P	250	39	-	80	19	15	18	4	008	○	
M27X3	P3	24	24.13	SPR027SL20	2.5P	200	39	-	80	20	15	18	4	008	○	
	P3	24	24.13	SPR027SL25	2.5P	250	39	-	80	20	15	18	4	008	○	
M30X3.5	P4	26.5	26.63	SPS030TL20	2.5P	200	46	-	80	23	17	20	4	008	○	
	P4	26.5	26.63	SPS030TL25	2.5P	250	46	-	80	23	17	20	4	008	○	
	P4	26.5	26.63	SPS030TL30	2.5P	300	46	-	80	23	17	20	4	008	○	
MF																
JIS																
M6X0.75	P2	5.3	5.33	SPFQ6.0JL10	2.5P	100	15	30	40	6	4.5	7	3	005	○	
	M8X1	P2	7	7.09	SPQ8.0ML10	2.5P	100	19	-	50	6.2	5	8	3	008	○
		P2	7	7.09	SPQ8.0ML15	2.5P	150	19	-	50	6.2	5	8	3	008	○
M8X0.75	P2	7	7.09	SPQ8.0ML12	2.5P	120	19	-	50	6.2	5	8	3	008	○	
	P2	7.25	7.33	SPQ8.0JL10	2.5P	100	19	-	50	6.2	5	8	3	008	○	
M10X1.25	P2	8.8	8.85	SPQ010NL10	2.5P	100	23	-	50	7	5.5	8	3	008	○	
	P2	8.8	8.85	SPQ010NL12	2.5P	120	23	-	50	7	5.5	8	3	008	○	
	P2	8.8	8.85	SPQ010NL15	2.5P	150	23	-	50	7	5.5	8	3	008	○	
	P2	8.8	8.85	SPQ010NL20	2.5P	200	23	-	50	7	5.5	8	3	008	○	

MF	TCTR (tolerance)	 Hole Ø (mm)	Hole Ø (mm)	Code	THCHT (chamfer)	LF (mm)	THL (mm)	LU (mm)	LS (mm)	DCON (mm)	K (mm)	LK (mm)	NOF	Type	Stock
JIS															
M10X1	P2	9	9.09	SPQ010ML10	2.5P	100	23	-	50	7	5.5	8	3	008	○
	P2	9	9.09	SPQ010ML15	2.5P	150	23	-	50	7	5.5	8	3	008	○
	P2	9	9.09	SPQ010ML12	2.5P	120	23	-	50	7	5.5	8	3	008	○
M10X0.75	P2	9.3	9.33	SPQ010JL15	2.5P	150	13	-	50	7	5.5	8	3	008	○
M12X1.5	P2	10.5	10.6	SPQ0120L10	2.5P	100	26	-	50	8.5	6.5	9	3	008	○
	P2	10.5	10.6	SPQ0120L15	2.5P	150	26	-	50	8.5	6.5	9	3	008	○
	P2	10.5	10.6	SPQ0120L20	2.5P	200	26	-	50	8.5	6.5	9	3	008	○
	P2	10.5	10.6	SPQ0120L12	2.5P	120	26	-	50	8.5	6.5	9	3	008	○
M12X1.25	P2	10.8	10.85	SPQ012NL10	2.5P	100	26	-	50	8.5	6.5	9	3	008	○
	P2	10.8	10.85	SPQ012NL12	2.5P	120	26	-	50	8.5	6.5	9	3	008	○
	P2	10.8	10.85	SPQ012NL15	2.5P	150	26	-	50	8.5	6.5	9	3	008	○
	P2	10.8	10.85	SPQ012NL20	2.5P	200	26	-	50	8.5	6.5	9	3	008	○
M12X1	P2	11	11.09	SPQ012ML12	2.5P	120	26	-	50	8.5	6.5	9	3	008	○
	P2	11	11.09	SPQ012ML15	2.5P	150	26	-	50	8.5	6.5	9	3	008	○
	P2	11	11.09	SPQ012ML10	2.5P	100	26	-	50	8.5	6.5	9	3	008	○
M14X1.5	P2	12.5	12.6	SPQ0140L12	2.5P	120	26	-	60	10.5	8	11	3	008	○
	P2	12.5	12.6	SPQ0140L15	2.5P	150	26	-	60	10.5	8	11	3	008	●
	P2	12.5	12.6	SPQ0140L20	2.5P	200	26	-	60	10.5	8	11	3	008	○
M16X1.5	P2	14.5	14.6	SPQ0160L15	2.5P	150	26	-	60	12.5	10	13	3	008	○
	P2	14.5	14.6	SPQ0160L20	2.5P	200	26	-	60	12.5	10	13	3	008	○
M18X2	P3	16	16.12	SPR018QL20	2.5P	200	33	-	70	14	11	14	4	008	○
M18X1.5	P2	16.5	16.6	SPQ0180L15	2.5P	150	33	-	70	14	11	14	4	008	○
	P2	16.5	16.6	SPQ0180L20	2.5P	200	33	-	70	14	11	14	4	008	○
M20X2	P3	18	18.12	SPR020QL20	2.5P	200	33	-	70	15	12	15	4	008	○
M20X1.5	P3	18.5	18.6	SPR0200L15	2.5P	150	33	-	70	15	12	15	4	008	○
	P3	18.5	18.6	SPR0200L20	2.5P	200	33	-	70	15	12	15	4	008	○
M22X2	P3	20	20.12	SPR022QL20	2.5P	200	33	-	70	17	13	16	4	008	○
M22X1.5	P3	20.5	20.6	SPR0220L15	2.5P	150	33	-	70	17	13	16	4	008	○
	P3	20.5	20.6	SPR0220L20	2.5P	200	33	-	70	17	13	16	4	008	○
M24X2	P3	22	22.12	SPR024QL20	2.5P	200	39	-	80	19	15	18	4	008	○
M24X1.5	P3	22.5	22.6	SPR0240L15	2.5P	150	39	-	80	19	15	18	4	008	○
	P3	22.5	22.6	SPR0240L20	2.5P	200	39	-	80	19	15	18	4	008	○
M27X2	P3	25	25.12	SPR027QL20	2.5P	200	39	-	80	20	15	18	4	008	○
	P3	25	25.12	SPR027QL25	2.5P	250	39	-	80	20	15	18	4	008	○
M27X1.5	P3	25.5	25.6	SPR0270L20	2.5P	200	39	-	80	20	15	18	4	008	○
	P3	25.5	25.6	SPR0270L25	2.5P	250	39	-	80	20	15	18	4	008	○
M30X3	P3	27	27.13	SPR030SL25	2.5P	250	46	-	80	23	17	20	4	008	○
M30X2	P3	28	28.12	SPR030QL20	2.5P	200	46	-	80	23	17	20	4	008	○
	P3	28	28.12	SPR030QL25	2.5P	250	46	-	80	23	17	20	4	008	○
M30X1.5	P3	28.5	28.6	SPR0300L20	2.5P	200	46	-	80	23	17	20	4	008	○
	P3	28.5	28.6	SPR0300L25	2.5P	250	46	-	80	23	17	20	4	008	○
	P3	28.5	28.6	SPR0300L30	2.5P	300	46	-	80	23	17	20	4	008	○
JIS															
UNC	TCTR (tolerance)	 Hole Ø (mm)	Hole Ø (mm)	Code	THCHT (chamfer)	LF (mm)	THL (mm)	LU (mm)	LS (mm)	DCON (mm)	K (mm)	LK (mm)	NOF	Type	Stock
JIS															
1/4-20UNC	P2	5.1	5.19	SPFQU04NL10	2.5P	100	15	30	40	6	4.5	7	3	005	○
	P2	5.1	5.19	SPFQU04NL15	2.5P	150	15	30	40	6	4.5	7	3	005	○

Intro

SP

SL

PO

ST

ROLL

CARBIDE

LONG

JIS

HAND
TAPS

EG (STI)

SPECIAL
THREADS,
GAUGESTHREAD
MILLS

DIES

CENTER
DRILLSTechnical
info

Long Taps

Intro

	UNC	TCTR (tolerance)	\varnothing (mm)	Hole \varnothing (mm)	Code	THCHT (chamfer)	LF (mm)	THL (mm)	LU (mm)	LS (mm)	DCON (mm)	K (mm)	LK (mm)	NOF	Type	Stock
	JIS															
SP	5/16-18UNC	P2	6.6	6.65	SPQU050L10	2.5P	100	19	-	50	6.2	5	8	3	008	○
		P2	6.6	6.65	SPQU050L15	2.5P	150	19	-	50	6.2	5	8	3	008	○
SL	3/8-16UNC	P2	8	8.07	SPQU06PL10	2.5P	100	23	-	50	7	5.5	8	3	008	○
		P2	8	8.07	SPQU06PL15	2.5P	150	23	-	50	7	5.5	8	3	008	○
PO	7/16-14UNC	P3	9.4	9.45	SPRU07QL15	2.5P	150	26	-	50	8.5	6.5	9	3	008	○
		P3	10.9	10.91	SPRU08RL15	2.5P	150	26	-	60	10.5	8	11	3	008	○
ST	1/2-13UNC	P3	10.9	10.91	SPRU08RL20	2.5P	200	26	-	60	10.5	8	11	3	008	○
		P3	13.6	13.75	SPRU10UL15	2.5P	150	26	-	60	12.5	10	13	3	008	○
ROLL	5/8-11UNC	P3	13.6	13.75	SPRU10UL20	2.5P	200	26	-	60	12.5	10	13	3	008	○
		P3	16.6	16.7	SPRU12VL15	2.5P	150	33	-	70	15	12	15	4	008	○
CARBIDE	3/4-10UNC	P3	16.6	16.7	SPRU12VL20	2.5P	200	33	-	70	15	12	15	4	008	○
		P3	19.6	19.61	SPRU14WL15	2.5P	150	33	-	70	17	13	16	4	008	○
LONG JIS	7/8-9UNC	P3	19.6	19.61	SPRU14WL20	2.5P	200	33	-	70	17	13	16	4	008	○
		P3	22.3	22.45	SPRU16XL15	2.5P	150	39	-	80	19	15	18	4	008	○
HAND TAPS	1-8UNC	P3	22.3	22.45	SPRU16XL20	2.5P	200	39	-	80	19	15	18	4	008	○

ROLL

CARBIDE

LONG

JIS

HAND

TAPS

EG (STI)

SPECIAL

THREADS,
GAUGES

THREAD

MILLS

DIES

CENTER

DRILLS

Technical

info

	UNF	TCTR (tolerance)	\varnothing (mm)	Hole \varnothing (mm)	Code	THCHT (chamfer)	LF (mm)	THL (mm)	LU (mm)	LS (mm)	DCON (mm)	K (mm)	LK (mm)	NOF	Type	Stock
	JIS															
CARBIDE	1/4-28UNF	P2	5.5	5.53	SPFQU04KL10	2.5P	100	15	30	40	6	4.5	7	3	005	○
		P2	5.5	5.53	SPFQU04KL15	2.5P	150	15	30	40	6	4.5	7	3	005	○
LONG JIS	5/16-24UNF	P2	6.9	6.97	SPQU05ML10	2.5P	100	19	-	50	6.2	5	8	3	008	○
		P2	6.9	6.97	SPQU05ML15	2.5P	150	19	-	50	6.2	5	8	3	008	○
HAND TAPS	3/8-24UNF	P2	8.5	8.57	SPQU06ML10	2.5P	100	23	-	50	7	5.5	8	3	008	○
		P2	8.5	8.57	SPQU06ML15	2.5P	150	23	-	50	7	5.5	8	3	008	○
EG (STI)	7/16-20UNF	P2	8.5	8.57	SPQU06ML20	2.5P	200	23	-	50	7	5.5	8	3	008	○
		P2	9.9	9.96	SPQU07NL15	2.5P	150	26	-	50	8.5	6.5	9	3	008	○
SPECIAL THREADS, GAUGES	1/2-20UNF	P2	11.5	11.54	SPQU08NL15	2.5P	150	26	-	60	10.5	8	11	3	008	○
		P2	11.5	11.54	SPQU08NL20	2.5P	200	26	-	60	10.5	8	11	3	008	○
THREAD MILLS	5/8-18UNF	P2	14.5	14.6	SPQU100L15	2.5P	150	26	-	60	12.5	10	13	3	008	○
		P2	14.5	14.6	SPQU100L20	2.5P	200	26	-	60	12.5	10	13	3	008	○
DIES	3/4-16UNF	P3	17.5	17.59	SPRU12PL15	2.5P	150	33	-	70	15	12	15	4	008	○
		P3	17.5	17.59	SPRU12PL20	2.5P	200	33	-	70	15	12	15	4	008	○
CENTER DRILLS	7/8-14UNF	P3	20.5	20.57	SPRU14QL20	2.5P	200	33	-	70	17	13	16	4	008	○
		P3	23.3	23.46	SPRU16SL20	2.5P	200	39	-	80	19	15	18	4	008	○
DIES	1-12UNF	P3	23.3	23.46	SPRU16SL20	2.5P	200	39	-	80	19	15	18	4	008	○

Technical

info

BSW	TCTR (tolerance)	 Hole Ø (mm)	Hole Ø (mm)	Code	THCHT (chamfer)	LF (mm)	THL (mm)	LU (mm)	LS (mm)	DCON (mm)	K (mm)	LK (mm)	NOF	Type	Stock
JIS															
1/2W12	P3	10.6	10.7	SPRW08SL15	2.5P	150	26	-	60	10.5	8	11	3	008	○
	P3	10.6	10.7	SPRW08SL20	2.5P	200	26	-	60	10.5	8	11	3	008	○
5/8W11	P3	13.5	13.68	SPRW10UL15	2.5P	150	26	-	60	12.5	10	13	3	008	○
	P3	13.5	13.68	SPRW10UL20	2.5P	200	26	-	60	12.5	10	13	3	008	○
3/4W10	P3	16.5	16.63	SPRW12VL15	2.5P	150	33	-	70	15	12	15	4	008	○
	P3	16.5	16.63	SPRW12VL20	2.5P	200	33	-	70	15	12	15	4	008	○
7/8W9	P3	19.5	19.53	SPRW14WL15	2.5P	150	33	-	70	17	13	16	4	008	○
	P3	19.5	19.53	SPRW14WL20	2.5P	200	33	-	70	17	13	16	4	008	○
1 W8	P3	22.2	22.34	SPRW16XL15	2.5P	150	39	-	80	19	15	18	4	008	○
	P3	22.2	22.34	SPRW16XL20	2.5P	200	39	-	80	19	15	18	4	008	○

Intro

SP

SL

PO

ST

ROLL

CARBIDE

LONG

JIS

HAND
TAPS

EG (STI)

SPECIAL
THREADS,
GAUGESTHREAD
MILLS

DIES

CENTER
DRILLSTechnical
info

Intro

LS-SP-PF



SP

GP General Purpose Series

Long Shank Spiral Fluted Taps for Parallel Pipe Threads

SL



PO

Recommended Tapping Speeds Depending On Materials

ISO	Vc (m/min)	ISO	Vc (m/min)
P1	5÷10 ☆	N1	5÷10 ☆
P2	5÷10 ★	N2	5÷10 ☆
P3	5÷10 ☆	N3	5÷10 ☆
P4	5÷10 ☆	N4	5÷10 ☆

★ 1st choice ☆ suitable

ROLL

CARBIDE

LONG

JIS

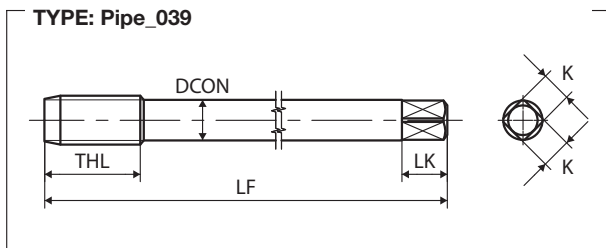

HAND TAPS

EG (STI)

SPECIAL THREADS, GAUGES

THREAD MILLS

DIES

CENTER DRILLS

Technical info

G(BSP)	TCTR (tolerance)	∅ (mm)	Hole ∅ (mm)	Code	THCHT (chamfer)	Basic major ∅ (mm)	LF (mm)	THL (mm)	LS (mm)	DCON (mm)	K (mm)	LK (mm)	NOF	Type	Stock
JIS															
1/8-28		8.75	8.78	SH2F02KL10	2.5P	9.728	100	19	-	8	6	9	3	039	○
		8.75	8.78	SH2F02KL12	2.5P	9.728	120	19	-	8	6	9	3	039	○
		8.75	8.78	SH2F02KL15	2.5P	9.728	150	19	-	8	6	9	3	039	○
1/4-19		11.75	11.78	SH2F04-L10	2.5P	13.157	100	28	-	11	9	12	3	039	○
		11.75	11.78	SH2F04-L12	2.5P	13.157	120	28	-	11	9	12	3	039	○
		11.75	11.78	SH2F04-L15	2.5P	13.157	150	28	-	11	9	12	3	039	○
3/8-19		15.25	15.28	SH2F06-L12	2.5P	16.662	120	28	-	14	11	14	3	039	○
		15.25	15.28	SH2F06-L15	2.5P	16.662	150	28	-	14	11	14	3	039	○
1/2-14		19	19.04	SH2F08QL15	2.5P	20.955	150	35	-	18	14	17	4	039	○
3/4-14		24.5	24.52	SH2F12QL15	2.5P	26.441	150	35	-	23	17	20	4	039	○
1-11		30.75	30.77	SH2F16UL15	2.5P	33.249	150	45	-	26	21	24	4	039	○
		30.75	30.77	SH2F16UL20	2.5P	33.249	200	45	-	26	21	24	4	039	○

FEATURES

Long shank general purpose for extended overhang on blind hole application.

For steel application at medium-low cutting speed, also suitable for non-ferrous materials.

LS-SP-K

GP General Purpose Series

Long Shank Spiral Fluted Taps with Long Neck



FEATURES

For steel application at medium-low cutting speed, also suitable for non-ferrous materials.

For tapping steel at medium-low cutting speed, also suitable for non-ferrous materials.

Reduced neck for deep holes.

Recommended Tapping Speeds Depending On Materials

ISO	Vc (m/min)	ISO	Vc (m/min)
P1	5÷10 ☆	N1	5÷10 ☆
P2	5÷10 ★	N2	5÷10 ☆
P3	5÷10 ☆	N3	5÷10 ☆
P4	5÷8 ☆	N4	5÷10 ☆

★ 1st choice ☆ suitable

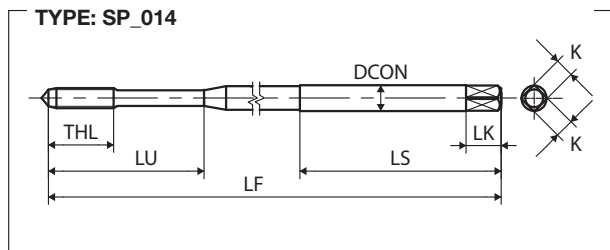

M	TCTR (tolerance)	Hole Ø (mm)	Hole Ø (mm)	Code	THCHT (chamfer)	LF (mm)	THL (mm)	LU (mm)	LS (mm)	DCON (mm)	K (mm)	LK (mm)	NOF	Type	Stock
JIS															
M3X0.5	P1	2.5	2.56	SY3.0GPFEBE	2.5P	100	9	28	40	4	3.2	6	2	014	○
	P1	2.5	2.56	SY3.0GPFEBF	2.5P	120	9	28	40	4	3.2	6	2	014	○
	P1	2.5	2.56	SY3.0GPFEBG	2.5P	150	9	28	40	4	3.2	6	2	014	○
M4X0.7	P2	3.3	3.38	SY4.0IQFEBE	2.5P	100	11	31	40	5	4	7	3	014	○
	P2	3.3	3.38	SY4.0IQFEBF	2.5P	120	11	31	40	5	4	7	3	014	○
	P2	3.3	3.38	SY4.0IQFEBG	2.5P	150	11	31	40	5	4	7	3	014	○
M5X0.8	P2	4.2	4.28	SY5.0KQFEBE	2.5P	100	13	38	40	5.5	4.5	7	3	014	○
	P2	4.2	4.28	SY5.0KQFEBF	2.5P	120	13	38	40	5.5	4.5	7	3	014	○
	P2	4.2	4.28	SY5.0KQFEBG	2.5P	150	13	38	40	5.5	4.5	7	3	014	○
M6X1	P2	5	5.09	SY6.0MQFEBE	2.5P	100	15	45	40	6	4.5	7	3	014	○
	P2	5	5.09	SY6.0MQFEBF	2.5P	120	15	45	40	6	4.5	7	3	014	○
	P2	5	5.09	SY6.0MQFEBG	2.5P	150	15	45	40	6	4.5	7	3	014	○

Intro

SP

SL

PO

ST

ROLL

CARBIDE

LONG

JIS

HAND TAPS

EG (STI)

SPECIAL THREADS, GAUGES

THREAD MILLS

DIES

CENTER DRILLS

Technical info

Intro

LS-SP LH



SP

GP General Purpose Series

Long Shank Spiral Fluted Taps for Left Hand Threads

SL



PO

Recommended Tapping Speeds Depending On Materials

ISO	Vc (m/min)	ISO	Vc (m/min)
P1	5±10 ☆	N1	5±10 ☆
P2	5±10 ★	N2	5±10 ☆
P3	5±10 ☆	N3	5±10 ☆
P4	5±8 ☆	N4	5±10 ☆

★ 1st choice ☆ suitable

ROLL

CARBIDE

LONG

JIS

HAND TAPS

EG (STI)

SPECIAL THREADS, GAUGES

THREAD MILLS

DIES

CENTER DRILLS

Technical info

FEATURES

Long shank general purpose for extended overhang on blind hole application.

For steel application at medium-low cutting speed, also suitable for non-ferrous materials.

For left hand threads.

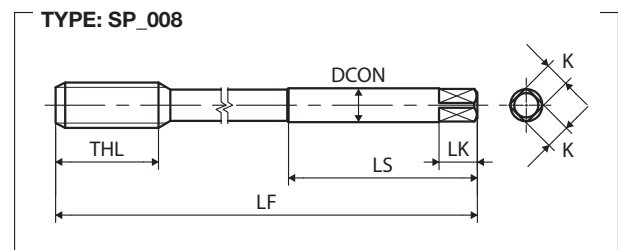
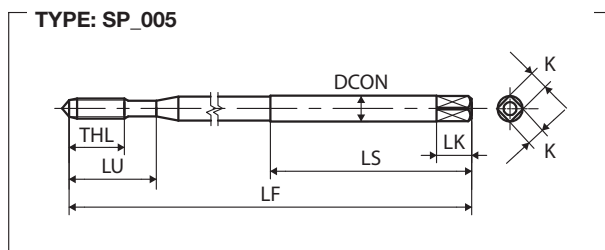

M	TCTR (tolerance)	∅ (mm)	Hole ∅ (mm)	Code	THCHT (chamfer)	LF (mm)	THL (mm)	LU (mm)	LS (mm)	DCON (mm)	K (mm)	LK (mm)	NOF	Type	Stock
JIS															
M3X0.5	P1	2.5	2.56	SPFP3.0GL10L	2.5P	100	9	18	40	4	3.2	6	3	005	○
M4X0.7	P2	3.3	3.38	SPFQ4.0IL10L	2.5P	100	11	21	40	5	4	7	3	005	○
M5X0.8	P2	4.2	4.28	SPFQ5.0KL10L	2.5P	100	13	25	40	5.5	4.5	7	3	005	○
M6X1	P2	5	5.09	SPFQ6.0ML10L	2.5P	100	15	30	40	6	4.5	7	3	005	○
	P2	5	5.09	SPFQ6.0ML15L	2.5P	150	15	30	40	6	4.5	7	3	005	○
M8X1.25	P2	6.8	6.85	SPQ8.0NL15-L	2.5P	150	19	-	50	6.2	5	8	3	008	○
M10X1.5	P2	8.5	8.6	SPQ0100L15-L	2.5P	150	23	-	50	7	5.5	8	3	008	○
M12X1.75	P2	10.3	10.36	SPQ012PL15-L	2.5P	150	26	-	50	8.5	6.5	9	3	008	○
M14X2	P2	12	12.12	SPQ014QL15-L	2.5P	150	26	-	60	10.5	8	11	3	008	○
M16X2	P2	14	14.12	SPQ016QL15-L	2.5P	150	26	-	60	12.5	10	13	3	008	○

MF	TCTR (tolerance)	∅ (mm)	Hole ∅ (mm)	Code	THCHT (chamfer)	LF (mm)	THL (mm)	LU (mm)	LS (mm)	DCON (mm)	K (mm)	LK (mm)	NOF	Type	Stock
JIS															
M10X1.25	P2	8.8	8.85	SPQ010NL15-L	2.5P	150	23	-	50	7	5.5	8	3	008	○
M12X1.5	P2	10.5	10.6	SPQ0120L15-L	2.5P	150	26	-	50	8.5	6.5	9	3	008	○
M12X1.25	P2	10.8	10.85	SPQ012NL15-L	2.5P	150	26	-	50	8.5	6.5	9	3	008	○
M14X1.5	P2	12.5	12.6	SPQ0140L15-L	2.5P	150	26	-	60	10.5	8	11	3	008	○
M16X1.5	P2	14.5	14.6	SPQ0160L15-L	2.5P	150	26	-	60	12.5	10	13	3	008	○

LS-SP V

GP General Purpose Series

Long Shank Spiral Fluted Taps, coated



FEATURES

Long shank for extended overhang on blind hole application.

For steel application at medium-low cutting speed, also suitable for non-ferrous materials.

Adopting suitable coating to improve performances.

Recommended Tapping Speeds Depending On Materials

ISO	Vc (m/min)	ISO	Vc (m/min)	ISO	Vc (m/min)
P1	10÷20 ★	M1	6÷12 ☆	N1	10÷20 ☆
P2	10÷20 ★			N2	10÷20 ☆
P3	10÷20 ★			N3	10÷20 ☆
P4	10÷15 ★			N4	10÷20 ☆
P7	6÷12 ☆				

★ 1st choice ☆ suitable

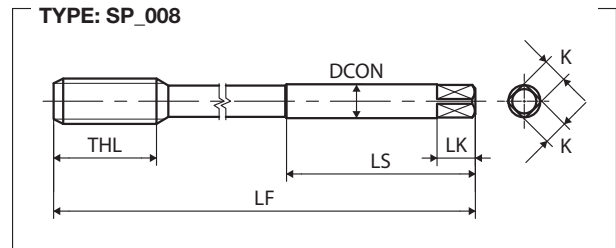
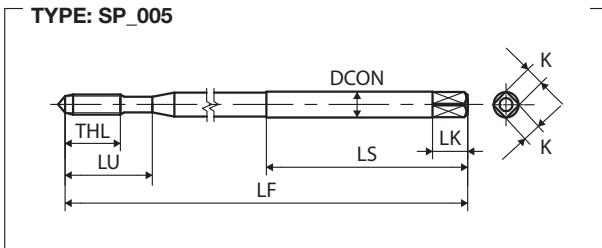

M	TCTR (tolerance)	Hole Ø (mm)	Hole Ø (mm)	Code	THCHT (chamfer)	LF (mm)	THL (mm)	LU (mm)	LS (mm)	DCON (mm)	K (mm)	LK (mm)	NOF	Type	Stock
JIS															
M3X0.5	P1	2.5	2.56	VSPFP3.0GL10	2.5P	100	9	18	40	4	3.2	6	3	005	○
M4X0.7	P2	3.3	3.38	VSPFQ4.0IL10	2.5P	100	11	21	40	5	4	7	3	005	○
M5X0.8	P2	4.2	4.28	VSPFQ5.0KL10	2.5P	100	13	25	40	5.5	4.5	7	3	005	○
M6X1	P2	5	5.09	VSPFQ6.0ML10	2.5P	100	15	30	40	6	4.5	7	3	005	○
	P2	5	5.09	VSPFQ6.0ML15	2.5P	150	15	30	40	6	4.5	7	3	005	○
M8X1.25	P2	6.8	6.85	VSPQ8.0NL10	2.5P	100	19	-	50	6.2	5	8	3	008	○
	P2	6.8	6.85	VSPQ8.0NL15	2.5P	150	19	-	50	6.2	5	8	3	008	○
M10X1.5	P2	8.5	8.6	VSPQ100L15	2.5P	150	23	-	50	7	5.5	8	3	008	○
M12X1.75	P2	10.3	10.36	VSPQ12PL15	2.5P	150	26	-	50	8.5	6.5	9	3	008	○
MF	TCTR (tolerance)	Hole Ø (mm)	Hole Ø (mm)	Code	THCHT (chamfer)	LF (mm)	THL (mm)	LU (mm)	LS (mm)	DCON (mm)	K (mm)	LK (mm)	NOF	Type	Stock
JIS															
M10X1.25	P2	8.8	8.85	VSPQ10NL15	2.5P	150	23	-	50	7	5.5	8	3	008	○
M12X1.5	P2	10.5	10.6	VSPQ120L15	2.5P	150	26	-	50	8.5	6.5	9	3	008	○
M12X1.25	P2	10.8	10.85	VSPQ12NL15	2.5P	150	26	-	50	8.5	6.5	9	3	008	○

Intro

SP

SL

PO

ST

ROLL

CARBIDE

LONG JIS

HAND TAPS

EG (STI)

SPECIAL THREADS, GAUGES

THREAD MILLS

DIES

CENTER DRILLS

Technical info

Intro

MC-SP



SP

GP General Purpose Series

Long Shank Spiral Fluted Taps with Axial Coolant Hole

SL



PO

Recommended Tapping Speeds Depending On Materials

ISO	Vc (m/min)	ISO	Vc (m/min)
P1	5÷10 ☆	N1	5÷10 ☆
P2	5÷10 ★	N2	5÷10 ☆
P3	5÷10 ☆	N3	5÷10 ☆
P4	5÷8 ☆	N4	5÷10 ☆

★ 1st choice ☆ suitable

ROLL

CARBIDE

LONG

JIS

HAND TAPS

EG (STI)

SPECIAL THREADS, GAUGES

THREAD MILLS

DIES

CENTER DRILLS

Technical info

FEATURES

Long shank general purpose for extended overhang on blind hole application.

For steel application at medium-low cutting speed, also suitable for non-ferrous materials.

With axial coolant hole.

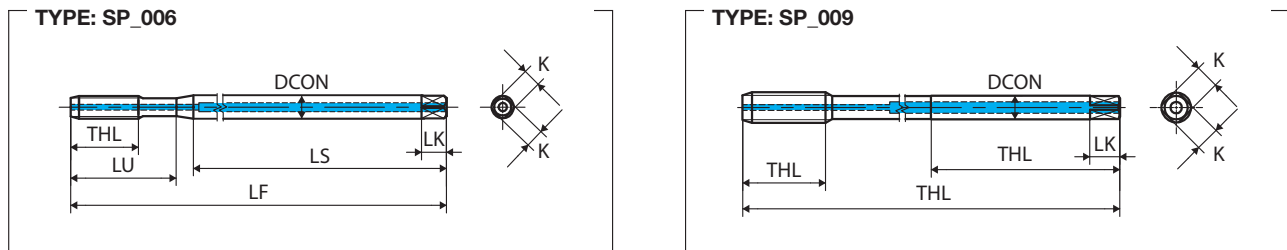

M	TCTR (tolerance)	Hole Ø (mm)	Hole Ø (mm)	Code	THCHT (chamfer)	LF (mm)	THL (mm)	LU (mm)	LS (mm)	DCON (mm)	K (mm)	LK (mm)	NOF	Type	Stock
JIS															
M6X1	P2	5	5.09	MSHQ6.0ML10	2.5P	100	19	28	40	6	4.5	7	3	006	○
	P2	5	5.09	MSHQ6.0ML15	2.5P	150	19	28	40	6	4.5	7	3	006	○
M8X1.25	P2	6.8	6.85	MSHQ8.0NL10	2.5P	100	22	-	50	6.2	5	8	3	009	○
	P2	6.8	6.85	MSHQ8.0NL15	2.5P	150	22	-	50	6.2	5	8	3	009	○
M10X1.5	P2	8.5	8.6	MSHQ10.0L10	2.5P	100	24	-	50	7	5.5	8	3	009	○
	P2	8.5	8.6	MSHQ10.0L15	2.5P	150	24	-	50	7	5.5	8	3	009	○
M12X1.75	P2	10.3	10.36	MSHQ12.0L10	2.5P	100	29	-	50	8.5	6.5	9	3	009	○
	P2	10.3	10.36	MSHQ12.0L15	2.5P	150	29	-	50	8.5	6.5	9	3	009	○
	P2	10.3	10.36	MSHQ12.0L20	2.5P	200	29	-	50	8.5	6.5	9	3	009	○
M14X2	P2	12	12.12	MSHQ14.0L15	2.5P	150	30	-	60	10.5	8	11	3	009	○
	P2	12	12.12	MSHQ14.0L20	2.5P	200	30	-	60	10.5	8	11	3	009	○
M16X2	P2	14	14.12	MSHQ16.0L15	2.5P	150	32	-	60	12.5	10	13	3	009	○
	P2	14	14.12	MSHQ16.0L20	2.5P	200	32	-	60	12.5	10	13	3	009	○
M18X2.5	P3	15.5	15.63	MSHR18.0L15	2.5P	150	37	-	70	14	11	14	4	009	○
	P3	15.5	15.63	MSHR18.0L20	2.5P	200	37	-	70	14	11	14	4	009	○

M	TCTR (tolerance)	 Hole Ø (mm)	Hole Ø (mm)	Code	THCHT (chamfer)	LF (mm)	THL (mm)	LU (mm)	LS (mm)	DCON (mm)	K (mm)	LK (mm)	NOF	Type	Stock
JIS															
M20X2.5	P3	17.5	17.63	MSHR020RL15	2.5P	150	37	-	70	15	12	15	4	009	○
	P3	17.5	17.63	MSHR020RL20	2.5P	200	37	-	70	15	12	15	4	009	○
M22X2.5	P3	19.5	19.63	MSHR022RL15	2.5P	150	38	-	70	17	13	16	4	009	○
	P3	19.5	19.63	MSHR022RL20	2.5P	200	38	-	70	17	13	16	4	009	○
M24X3	P3	21	21.13	MSHR024SL15	2.5P	150	45	-	80	19	15	18	4	009	○
	P3	21	21.13	MSHR024SL20	2.5P	200	45	-	80	19	15	18	4	009	○
M27X3	P3	24	24.13	MSHR027SL20	2.5P	200	45	-	80	20	15	18	4	009	○
	P3	24	24.13	MSHR027SL25	2.5P	250	45	-	80	20	15	18	4	009	○
M30X3.5	P4	26.5	26.63	MSHS030TL20	2.5P	200	48	-	80	23	17	20	4	009	○
	P4	26.5	26.63	MSHS030TL25	2.5P	250	48	-	80	23	17	20	4	009	○
JIS															
M10X1.25	P2	8.8	8.85	MSHQ010NL10	2.5P	100	24	-	50	7	5.5	8	3	009	○
	P2	8.8	8.85	MSHQ010NL15	2.5P	150	24	-	50	7	5.5	8	3	009	○
M12X1.5	P2	10.5	10.6	MSHQ0120L10	2.5P	100	29	-	50	8.5	6.5	9	3	009	○
	P2	10.5	10.6	MSHQ0120L15	2.5P	150	29	-	50	8.5	6.5	9	3	009	○
M12X1.25	P2	10.8	10.85	MSHQ012NL10	2.5P	100	29	-	50	8.5	6.5	9	3	009	○
	P2	10.8	10.85	MSHQ012NL15	2.5P	150	29	-	50	8.5	6.5	9	3	009	○
M14X1.5	P2	12.5	12.6	MSHQ0140L15	2.5P	150	30	-	60	10.5	8	11	3	009	○
	P2	12.5	12.6	MSHQ0140L20	2.5P	200	30	-	60	10.5	8	11	3	009	○
M16X1.5	P2	14.5	14.6	MSHQ0160L15	2.5P	150	32	-	60	12.5	10	13	3	009	○
	P2	14.5	14.6	MSHQ0160L20	2.5P	200	32	-	60	12.5	10	13	3	009	○
M18X1.5	P2	16.5	16.6	MSHQ0180L15	2.5P	150	37	-	70	14	11	14	4	009	○
	P2	16.5	16.6	MSHQ0180L20	2.5P	200	37	-	70	14	11	14	4	009	○
M20X1.5	P3	18.5	18.6	MSHR0200L15	2.5P	150	37	-	70	15	12	15	4	009	○
	P3	18.5	18.6	MSHR0200L20	2.5P	200	37	-	70	15	12	15	4	009	○
M22X1.5	P3	20.5	20.6	MSHR0220L15	2.5P	150	38	-	70	17	13	16	4	009	○
	P3	20.5	20.6	MSHR0220L20	2.5P	200	38	-	70	17	13	16	4	009	○
M24X1.5	P3	22.5	22.6	MSHR0240L15	2.5P	150	45	-	80	19	15	18	4	009	○
	P3	22.5	22.6	MSHR0240L20	2.5P	200	45	-	80	19	15	18	4	009	○
M27X1.5	P3	25.5	25.6	MSHR0270L20	2.5P	200	45	-	80	20	15	18	4	009	○
	P3	25.5	25.6	MSHR0270L25	2.5P	250	45	-	80	20	15	18	4	009	○
M30X1.5	P3	28.5	28.6	MSHR0300L20	2.5P	200	45	-	80	23	17	20	4	009	○
	P3	28.5	28.6	MSHR0300L25	2.5P	250	45	-	80	23	17	20	4	009	○

Intro

SP

SL

PO

ST

ROLL

CARBIDE

LONG

JIS

HAND
TAPS

EG (STI)

SPECIAL
THREADS,
GAUGES

THREAD
MILLS

DIES

CENTER
DRILLS

Technical
info

Intro

LS-PM-SP



MS Material Specific Series

SP Long Shank Spiral Fluted Taps for Hard Materials (<45HRC)

SL



PO

Recommended Tapping Speeds Depending On Materials

ISO	Vc (m/min)
P3	2÷10 ☆
P4	2÷7 ★
P5	2÷7 ★
P6	2÷5 ★

★ 1st choice ☆ suitable

ST

ROLL

CARBIDE

LONG

JIS

HAND TAPS

EG (STI)

SPECIAL THREADS, GAUGES

THREAD MILLS

DIES

CENTER DRILLS

Technical info

FEATURES

Long shank material specific for extended overhang on blind hole application.

Specific design and high class HSSP for stable and long life on alloy steel and tool steel (30 ÷ 45HRC) application.

Reliable and high performance tapping for the mould&die industry.

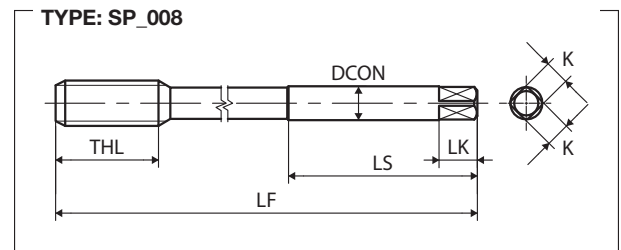
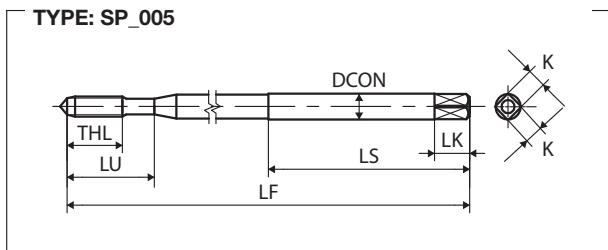

Old Code
New Code

M	TCTR (tolerance)	∅ (mm)	Hole ∅ (mm)	Code	THCHT (chamfer)	LF (mm)	THL (mm)	LU (mm)	LS (mm)	DCON (mm)	K (mm)	LK (mm)	NOF	Type	Stock
JIS															
M3X0.5	P3	2.5	2.56	SY3.0GRDPBE	2.75P	100	9	14	40	4	3.2	6	3	005	▽
	P3	2.5	2.56	S43.0GRDPBE	2.75P	100	9	18	40	4	3.2	6	3	005	●
M4X0.7	P3	3.3	3.38	SY4.0IRDPBE	2.75P	100	11	17	40	5	4	7	3	005	▽
	P3	3.3	3.38	S44.0IRDPBE	2.75P	100	11	21	40	5	4	7	3	005	●
M5X0.8	P3	4.2	4.28	SY5.0KRDPE	2.75P	100	13	22	40	5.5	4.5	7	3	005	▽
	P3	4.2	4.28	S45.0KRDPE	2.75P	100	13	25	40	5.5	4.5	7	3	005	●
M6X1	P3	5	5.09	S46.0MRDPBE	2.75P	100	15	30	40	6	4.5	7	3	005	○
	P3	5	5.09	SY6.0MRDPBG	2.75P	150	15	26	40	6	4.5	7	3	005	▽
	P3	5	5.09	S46.0MRDPBG	2.75P	150	15	30	40	6	4.5	7	3	005	●
M8X1.25	P3	6.8	6.85	SY8.0NRDPBE	2.75P	100	19	-	50	6.2	5	8	3	008	○
	P3	6.8	6.85	SY8.0NRDPBG	2.75P	150	19	-	50	6.2	5	8	3	008	●
M10X1.5	P3	8.5	8.6	SY0100RDPBG	2.75P	150	23	-	50	7	5.5	8	3	008	●
M12X1.75	P3	10.3	10.36	SY012PRDPBG	2.75P	150	26	-	50	8.5	6.5	9	3	008	●
M14X2	P4	12	12.12	SY014QSDPBG	2.75P	150	26	-	60	10.5	8	11	3	008	○
M16X2	P4	14	14.12	SY016QSDPBG	2.75P	150	26	-	60	12.5	10	13	3	008	○
M18X2.5	P4	15.5	15.63	SY018RSDPBG	2.75P	150	33	-	70	14	11	14	4	008	○
M20X2.5	P4	17.5	17.63	SY020RSDPBG	2.75P	150	33	-	70	15	12	15	4	008	○
M22X2.5	P4	19.5	19.63	SY022RSDPBK	2.75P	200	33	-	70	17	13	16	4	008	○
M24X3	P4	21	21.13	SY024SSDPBK	2.75P	200	39	-	80	19	15	18	4	008	○
M27X3	P4	24	24.13	SY027SSDPBK	2.75P	200	39	-	80	20	15	18	4	008	○
M30X3.5	P4	26.5	26.63	SY030TSDPBK	2.75P	200	46	-	80	23	17	20	4	008	○
MF															
JIS															
M10X1.25	P3	8.8	8.85	SY010NRDPBG	2.75P	150	23	-	50	7	5.5	8	3	008	○
M12X1.5	P3	10.5	10.6	SY0120RDPBG	2.75P	150	26	-	50	8.5	6.5	9	3	008	○
M12X1.25	P4	10.8	10.85	SY012NSDPBG	2.75P	150	26	-	50	8.5	6.5	9	3	008	○
M14X1.5	P3	12.5	12.6	SY0140RDPBG	2.75P	150	26	-	60	10.5	8	11	3	008	○
M16X1.5	P3	14.5	14.6	SY0160RDPBG	2.75P	150	26	-	60	12.5	10	13	3	008	○
M18X1.5	P4	16.5	16.6	SY0180SDPBG	2.75P	150	33	-	70	14	11	14	4	008	○
M20X1.5	P4	18.5	18.6	SY0200SDPBG	2.75P	150	33	-	70	15	12	15	4	008	○
M22X1.5	P4	20.5	20.6	SY0220SDPBK	2.75P	200	33	-	70	17	13	16	4	008	○
M24X1.5	P4	22.5	22.6	SY0240SDPBK	2.75P	200	39	-	80	19	15	18	4	008	○
M27X1.5	P4	25.5	25.6	SY0270SDPBK	2.75P	200	39	-	80	20	15	18	4	008	○
M30X1.5	P4	28.5	28.6	SY0300SDPBK	2.75P	200	46	-	80	23	17	20	4	008	○

Intro
SP
SL
PO
ST
ROLL
CARBIDE
LONG
JIS
HAND TAPS
EG (STI)
SPECIAL THREADS, GAUGES
THREAD MILLS
DIES
CENTER DRILLS
Technical info

Intro

LS-SU-S-SP

MS Material Specific Series

SP Long Shank Spiral Fluted Taps for Stainless Steel



SL



PO

Recommended Tapping Speeds Depending On Materials

ISO	Vc (m/min)	★	ISO	Vc (m/min)	★
P2	≤10	★	M1	≤10	★
P3	≤10	★			
P4	≤10	☆			
P7	≤10	★			

★ 1st choice ☆ suitable

ROLL

CARBIDE

LONG
JIS

HAND
TAPS

EG (STI)

SPECIAL
THREADS,
GAUGES

THREAD
MILLS

DIES

CENTER
DRILLS

Technical
info

FEATURES

Long shank for extended overhang on blind hole application.

Material specific for stainless steel and steel application.

With OX treatment to reduce welding troubles.

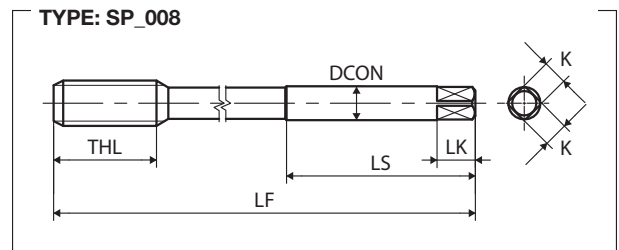
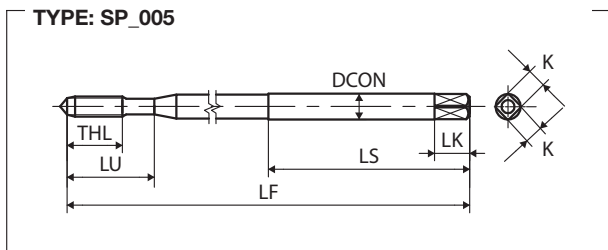

M	TCTR (tolerance)	∅ (mm)	Hole ∅ (mm)	Code	THCHT (chamfer)	LF (mm)	THL (mm)	LU (mm)	LS (mm)	DCON (mm)	K (mm)	LK (mm)	NOF	Type	Stock
JIS															
M3X0.5	P1	2.5	2.56	SY3.0GPGEXES	2.5P	100	9	28	40	4	3.2	6	2	005	●
M4X0.7	P2	3.3	3.38	SY4.0IQGEXES	2.5P	100	11	31	40	5	4	7	3	005	●
	P2	3.3	3.38	SY4.0IQGEXGS	2.5P	150	11	31	40	5	4	7	3	005	●
M5X0.8	P2	4.2	4.28	SY5.0KQGEXES	2.5P	100	13	38	40	5.5	4.5	7	3	005	●
	P2	4.2	4.28	SY5.0KQGEXGS	2.5P	150	13	38	40	5.5	4.5	7	3	005	●
M6X1	P2	5	5.09	SY6.0MQGEXES	2.5P	100	15	45	40	6	4.5	7	3	005	●
	P2	5	5.09	SY6.0MQGEXGS	2.5P	150	15	45	40	6	4.5	7	3	005	●
M8X1.25	P2	6.8	6.85	SY8.0NQGEXES	2.5P	100	12	-	50	6.2	5	8	3	008	○
	P2	6.8	6.85	SY8.0NQGEXGS	2.5P	150	12	-	50	6.2	5	8	3	008	●
	P2	6.8	6.85	SY8.0NQGEXKS	2.5P	200	12	-	50	6.2	5	8	3	008	○
M10X1.5	P2	8.5	8.6	SY0100QGEXES	2.5P	100	13	-	50	7	5.5	8	3	008	○
	P2	8.5	8.6	SY0100QGEXGS	2.5P	150	13	-	50	7	5.5	8	3	008	●
	P2	8.5	8.6	SY0100QGEXKS	2.5P	200	13	-	50	7	5.5	8	3	008	○
M12X1.75	P2	10.3	10.36	SY012PQGEXES	2.5P	100	15	-	50	8.5	6.5	9	3	008	○
	P2	10.3	10.36	SY012PQGEXGS	2.5P	150	15	-	50	8.5	6.5	9	3	008	●
	P2	10.3	10.36	SY012PQGEXKS	2.5P	200	15	-	50	8.5	6.5	9	3	008	○
M14X2	P2	12	12.12	SY014QQGEXGS	2.5P	150	18	-	60	10.5	8	11	3	008	○
M16X2	P2	14	14.12	SY016QQGEXGS	2.5P	150	18	-	60	12.5	10	13	3	008	○
	P2	14	14.12	SY016QQGEXKS	2.5P	200	18	-	60	12.5	10	13	3	008	○
M18X2.5	P3	15.5	15.63	SY018RRGEXGS	2.5P	150	20	-	70	14	11	14	4	008	○
	P3	15.5	15.63	SY018RRGEXKS	2.5P	200	20	-	70	14	11	14	4	008	○
M20X2.5	P3	17.5	17.63	SY020RRGEXGS	2.5P	150	20	-	70	15	12	15	4	008	○
	P3	17.5	17.63	SY020RRGEXKS	2.5P	200	20	-	70	15	12	15	4	008	○
M22X2.5	P3	19.5	19.63	SY022RRGEXGS	2.5P	150	20	-	70	17	13	16	4	008	○
	P3	19.5	19.63	SY022RRGEXKS	2.5P	200	20	-	70	17	13	16	4	008	○
M24X3	P3	21	21.13	SY024SRGEXGS	2.5P	150	25	-	80	19	15	18	4	008	○
	P3	21	21.13	SY024SRGEXKS	2.5P	200	25	-	80	19	15	18	4	008	○
JIS															
M10X1.25	P2	8.8	8.85	SY010NQGEXGS	2.5P	150	13	-	50	7	5.5	8	3	008	○
M12X1.5	P2	10.5	10.6	SY0120QGEXGS	2.5P	150	15	-	50	8.5	6.5	9	3	008	○
	P2	10.5	10.6	SY0120QGEXKS	2.5P	200	15	-	50	8.5	6.5	9	3	008	○
M12X1.25	P2	10.8	10.85	SY012NQGEXGS	2.5P	150	15	-	50	8.5	6.5	9	3	008	○
	P2	10.8	10.85	SY012NQGEXKS	2.5P	200	15	-	50	8.5	6.5	9	3	008	○
M14X1.5	P2	12.5	12.6	SY0140QGEXGS	2.5P	150	14	-	60	10.5	8	11	3	008	○
M16X1.5	P2	14.5	14.6	SY0160QGEXGS	2.5P	150	14	-	60	12.5	10	13	3	008	○
	P2	14.5	14.6	SY0160QGEXKS	2.5P	200	14	-	60	12.5	10	13	3	008	○
M18X1.5	P2	16.5	16.6	SY0180QGEXGS	2.5P	150	14	-	70	14	11	14	4	008	○
	P2	16.5	16.6	SY0180QGEXKS	2.5P	200	14	-	70	14	11	14	4	008	○
M20X1.5	P3	18.5	18.6	SY0200RGEXGS	2.5P	150	14	-	70	15	12	15	4	008	○
	P3	18.5	18.6	SY0200RGEXKS	2.5P	200	14	-	70	15	12	15	4	008	○
M22X1.5	P3	20.5	20.6	SY0220RGEXGS	2.5P	150	14	-	70	17	13	16	4	008	○
	P3	20.5	20.6	SY0220RGEXKS	2.5P	200	14	-	70	17	13	16	4	008	○
M24X1.5	P3	22.5	22.6	SY0240RGEXGS	2.5P	150	18	-	80	19	15	18	4	008	○
	P3	22.5	22.6	SY0240RGEXKS	2.5P	200	18	-	80	19	15	18	4	008	○

Intro

SP

SL

PO

ST

ROLL

CARBIDE

LONG
JIS

HAND
TAPS

EG (STI)

SPECIAL
THREADS,
GAUGES

THREAD
MILLS

DIES

CENTER
DRILLS

Technical
info

Intro

LS-PO

GP General Purpose Series

SP

Long Shank Spiral Pointed Taps

SL



PO

Recommended Tapping Speeds Depending On Materials

ISO	Vc (m/min)	ISO	Vc (m/min)
P1	5÷10 ☆	N1	5÷10 ☆
P2	5÷10 ★	N2	5÷10 ☆
P3	5÷10 ☆	N3	5÷10 ☆
P4	5÷8 ☆	N4	5÷10 ☆

★ 1st choice ☆ suitable

ROLL

CARBIDE

LONG
JIS

HAND
TAPS

EG (STI)

SPECIAL
THREADS,
GAUGES

THREAD
MILLS

DIES

CENTER
DRILLS

Technical
info



FEATURES

Long shank general purpose for extended overhang on through hole application.

For tapping steel, also suitable for non-ferrous materials.

TYPE: PO_011

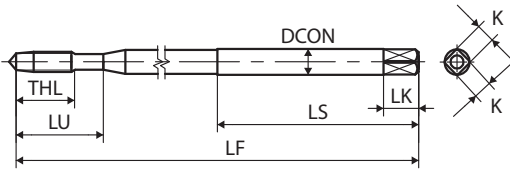

TYPE: PO_013

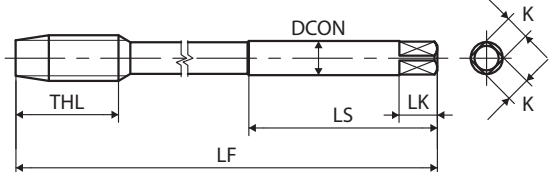

Oversized
Old Code
New Code

● stock standard, ● check stock EU, ○ check stock JP, ▽ stock exhaustion

M	TCTR (tolerance)	∅ (mm)	Hole ∅ (mm)	Code	THCHT (chamfer)	LF (mm)	THL (mm)	LU (mm)	LS (mm)	DCON (mm)	K (mm)	LK (mm)	NOF	Type	Stock
JIS															
M2X0.4	P2	1.6	1.65	POFQ2.0EL07	5P	70	7.2	15	52	3	2.5	5	3	011	○
M2.3X0.4	P2	1.9	1.95	POFQ2.3EL07	5P	70	7.2	15	52	3	2.5	5	3	011	○
M2.5X0.45	P2	2.1	2.11	POFQ2.5FL07	5P	70	8.1	15	52	3	2.5	5	3	011	○
M2.6X0.45	P2	2.2	2.21	POFQ2.6FL07	5P	70	8.1	15	52	3	2.5	5	3	011	○
M3X0.5	P2	2.5	2.56	POFQ3.0GL07	5P	70	9	18	46	4	3.2	6	3	011	○
	P2	2.5	2.56	POQ3.0GL10	5P	100	9	14	40	4	3.2	6	3	011	▽
	P2	2.5	2.56	POFQ3.0GL10	5P	100	9	18	40	4	3.2	6	3	011	●
	P2	2.5	2.56	POFQ3.0GL12	5P	120	9	18	40	4	3.2	6	3	011	○
	P2	2.5	2.56	POFQ3.0GL15	5P	150	9	18	40	4	3.2	6	3	011	○
	P3(P2+15)	2.5	2.56	POFR3.0GL10	5P	100	9	18	40	4	3.2	6	3	011	○
	P4(P2+30)	2.5	2.56	POFS3.0GL10	5P	100	9	18	40	4	3.2	6	3	011	○
P3(P2+15)	2.5	2.56	POFR3.0GL15	5P	150	9	18	40	4	3.2	6	3	011	○	
M4X0.7	P2	3.3	3.38	POFQ4.0IL07	5P	70	11	21	43	5	4	7	3	011	○
	P2	3.3	3.38	POQ4.0IL10	5P	100	11	17	40	5	4	7	3	011	▽
	P2	3.3	3.38	POFQ4.0IL10	5P	100	11	21	40	5	4	7	3	011	●
	P2	3.3	3.38	POFQ4.0IL12	5P	120	11	21	40	5	4	7	3	011	○
	P2	3.3	3.38	POQ4.0IL15	5P	150	11	17	40	5	4	7	3	011	▽
	P2	3.3	3.38	POFQ4.0IL15	5P	150	11	21	40	5	4	7	3	011	●
	P3(P2+20)	3.3	3.38	POFR4.0IL10	5P	100	11	21	40	5	4	7	3	011	○
P4(P2+40)	3.3	3.38	POFS4.0IL10	5P	100	11	21	40	5	4	7	3	011	○	
P3(P2+20)	3.3	3.38	POFR4.0IL15	5P	150	11	21	40	5	4	7	3	011	○	
M5X0.8	P2	4.2	4.28	POQ5.0KL10	5P	100	13	22	40	5.5	4.5	7	3	011	▽
	P2	4.2	4.28	POFQ5.0KL10	5P	100	13	25	40	5.5	4.5	7	3	011	●
	P2	4.2	4.28	POFQ5.0KL12	5P	120	13	25	40	5.5	4.5	7	3	011	○
	P2	4.2	4.28	POQ5.0KL15	5P	150	13	22	40	5.5	4.5	7	3	011	▽
	P2	4.2	4.28	POFQ5.0KL15	5P	150	13	25	40	5.5	4.5	7	3	011	●
	P3(P2+20)	4.2	4.28	POFR5.0KL10	5P	100	13	25	40	5.5	4.5	7	3	011	○
	P3(P2+20)	4.2	4.28	POFR5.0KL15	5P	150	13	25	40	5.5	4.5	7	3	011	○
P4(P2+40)	4.2	4.28	POFS5.0KL15	5P	150	13	25	40	5.5	4.5	7	3	011	○	
M6X1	P2	5	5.09	POQ6.0ML10	5P	100	15	26	40	6	4.5	7	3	011	▽
	P2	5	5.09	POFQ6.0ML10	5P	100	15	30	40	6	4.5	7	3	011	●
	P2	5	5.09	POFQ6.0ML12	5P	120	15	30	40	6	4.5	7	3	011	○
	P2	5	5.09	POQ6.0ML15	5P	150	15	26	40	6	4.5	7	3	011	▽
	P2	5	5.09	POFQ6.0ML15	5P	150	15	30	40	6	4.5	7	3	011	●
	P2	5	5.09	POFQ6.0ML20	5P	200	15	30	40	6	4.5	7	3	011	○
	P3(P2+20)	5	5.09	POFR6.0ML10	5P	100	15	30	40	6	4.5	7	3	011	○
P3(P2+20)	5	5.09	POFR6.0ML15	5P	150	15	30	40	6	4.5	7	3	011	○	
P4(P2+40)	5	5.09	POFS6.0ML15	5P	150	15	30	40	6	4.5	7	3	011	○	
M8X1.25	P3	6.8	6.85	POR8.0NL10	5P	100	19	-	50	6.2	5	8	3	013	●
	P3	6.8	6.85	POR8.0NL12	5P	120	19	-	50	6.2	5	8	3	013	○
	P3	6.8	6.85	POR8.0NL15	5P	150	19	-	50	6.2	5	8	3	013	●
	P3	6.8	6.85	POR8.0NL20	5P	200	19	-	50	6.2	5	8	3	013	○
	P4(P3+20)	6.8	6.85	POS8.0NL15	5P	150	19	-	50	6.2	5	8	3	013	○

Intro

SP

SL

PO

ST

ROLL

CARBIDE

LONG

JIS

HAND
TAPS

EG (STI)

SPECIAL
THREADS,
GAUGES

THREAD
MILLS

DIES

CENTER
DRILLS

Technical
info

Long Taps

Intro	M	TCTR (tolerance)	 Hole Ø (mm)	Hole Ø (mm)	Code	THCHT (chamfer)	LF (mm)	THL (mm)	LU (mm)	LS (mm)	DCON (mm)	K (mm)	LK (mm)	NOF	Type	Stock	
	JIS																
SP	M10X1.5	P3	8.5	8.6	POR0100L10	5P	100	23	-	50	7	5.5	8	3	013	○	
		P3	8.5	8.6	POR0100L12	5P	120	23	-	50	7	5.5	8	3	013	○	
		P3	8.5	8.6	POR0100L15	5P	150	23	-	50	7	5.5	8	3	013	●	
		P3	8.5	8.6	POR0100L20	5P	200	23	-	50	7	5.5	8	3	013	○	
SL	M12X1.75	P4(P3+20)	8.5	8.6	POS0100L15	5P	150	23	-	50	7	5.5	8	3	013	○	
		P4	10.3	10.36	POS012PL10	5P	100	26	-	50	8.5	6.5	9	3	013	○	
P4		10.3	10.36	POS012PL12	5P	120	26	-	50	8.5	6.5	9	3	013	○		
P4		10.3	10.36	POS012PL15	5P	150	26	-	50	8.5	6.5	9	3	013	●		
P4		10.3	10.36	POS012PL20	5P	200	26	-	50	8.5	6.5	9	3	013	○		
PO	M14X2	P5(P4+20)	10.3	10.36	POT012PL15	5P	150	26	-	50	8.5	6.5	9	3	013	○	
		P4	12	12.12	POS014QL12	5P	120	26	-	60	10.5	8	11	3	013	○	
P4		12	12.12	POS014QL15	5P	150	26	-	60	10.5	8	11	3	013	○		
P4		12	12.12	POS014QL20	5P	200	26	-	60	10.5	8	11	3	013	○		
P5(P4+20)		12	12.12	POT014QL15	5P	150	26	-	60	10.5	8	11	3	013	○		
ST	M16X2	P4	14	14.12	POS016QL15	5P	150	26	-	60	12.5	10	13	3	013	●	
		P4	14	14.12	POS016QL20	5P	200	26	-	60	12.5	10	13	3	013	●	
P4		14	14.12	POS016QL25	5P	250	26	-	60	12.5	10	13	3	013	○		
P5(P4+20)		14	14.12	POT016QL15	5P	150	26	-	60	12.5	10	13	3	013	○		
ROLL	M18X2.5	P4	15.5	15.63	POS018RL15	5P	150	33	-	70	14	11	14	3	013	○	
		P4	15.5	15.63	POS018RL20	5P	200	33	-	70	14	11	14	3	013	○	
P4		15.5	15.63	POS018RL25	5P	250	33	-	70	14	11	14	3	013	○		
P5(P4+20)		15.5	15.63	POT018RL15	5P	150	33	-	70	14	11	14	3	013	○		
P4		17.5	17.63	POS020RL15	5P	150	33	-	70	15	12	15	3	013	○		
LONG JIS	M20X2.5	P4	17.5	17.63	POS020RL20	5P	200	33	-	70	15	12	15	3	013	●	
		P4	17.5	17.63	POS020RL25	5P	250	33	-	70	15	12	15	3	013	○	
P5(P4+20)		17.5	17.63	POT020RL15	5P	150	33	-	70	15	12	15	3	013	○		
P4		19.5	19.63	POS022RL15	5P	150	33	-	70	17	13	16	3	013	○		
HAND TAPS	M22X2.5	P4	19.5	19.63	POS022RL20	5P	200	33	-	70	17	13	16	3	013	○	
		P4	19.5	19.63	POS022RL25	5P	250	33	-	70	17	13	16	3	013	○	
P4		21	21.13	POS024SL15	5P	150	39	-	80	19	15	18	3	013	○		
EG (STI)	M24X3	P4	21	21.13	POS024SL20	5P	200	39	-	80	19	15	18	3	013	○	
		P4	21	21.13	POS024SL25	5P	250	39	-	80	19	15	18	3	013	○	
P4		24	24.13	POS027SL20	5P	200	39	-	80	20	15	18	4	013	○		
SPECIAL THREADS, GAUGES	M27X3	P4	24	24.13	POS027SL25	5P	250	39	-	80	20	15	18	4	013	○	
		P5	26.5	26.63	POT030TL20	5P	200	46	-	80	23	17	20	4	013	○	
P5		26.5	26.63	POT030TL25	5P	250	46	-	80	23	17	20	4	013	○		
P5	26.5	26.63	POT030TL30	5P	300	46	-	80	23	17	20	4	013	○			
THREAD MILLS	MF	JIS															
		M8X1	P3	7	7.09	POR8.0ML10	5P	100	19	-	50	6.2	5	8	3	013	○
P3			7	7.09	POR8.0ML15	5P	150	19	-	50	6.2	5	8	3	013	○	
P3			7	7.09	POR8.0ML12	5P	120	19	-	50	6.2	5	8	3	013	○	
DIES		M10X1.25	P3	8.8	8.85	POR010NL10	5P	100	23	-	50	7	5.5	8	3	013	○
			P3	8.8	8.85	POR010NL15	5P	150	23	-	50	7	5.5	8	3	013	○
			P3	8.8	8.85	POR010NL20	5P	200	23	-	50	7	5.5	8	3	013	○
			P3	8.8	8.85	POR010NL12	5P	120	23	-	50	7	5.5	8	3	013	○
P4(P3+20)			8.8	8.85	POS010NL15	5P	150	23	-	50	7	5.5	8	3	013	○	
CENTER DRILLS		M10X1.25	P3	8.8	8.85	POR010NL10	5P	100	23	-	50	7	5.5	8	3	013	○
			P3	8.8	8.85	POR010NL15	5P	150	23	-	50	7	5.5	8	3	013	○
P3			8.8	8.85	POR010NL20	5P	200	23	-	50	7	5.5	8	3	013	○	

Technical
info

MF	TCTR (tolerance)	\varnothing (mm)	Hole \varnothing (mm)	Code	THCHT (chamfer)	LF (mm)	THL (mm)	LU (mm)	LS (mm)	DCON (mm)	K (mm)	LK (mm)	NOF	Type	Stock	
JIS																Intro
M10X1	P3	9	9.09	POR010ML10	5P	100	23	-	50	7	5.5	8	3	013	○	
	P3	9	9.09	POR010ML15	5P	150	23	-	50	7	5.5	8	3	013	○	SP
	P3	9	9.09	POR010ML12	5P	120	23	-	50	7	5.5	8	3	013	○	
M12X1.5	P3	10.5	10.6	POR0120L10	5P	100	26	-	50	8.5	6.5	9	3	013	○	
	P3	10.5	10.6	POR0120L15	5P	150	26	-	50	8.5	6.5	9	3	013	○	SL
	P3	10.5	10.6	POR0120L20	5P	200	26	-	50	8.5	6.5	9	3	013	○	
	P3	10.5	10.6	POR0120L12	5P	120	26	-	50	8.5	6.5	9	3	013	○	
	P4(P3+20)	10.5	10.6	POS0120L15	5P	150	26	-	50	8.5	6.5	9	3	013	○	
M12X1.25	P4	10.8	10.85	POS012NL10	5P	100	26	-	50	8.5	6.5	9	3	013	○	
	P4	10.8	10.85	POS012NL15	5P	150	26	-	50	8.5	6.5	9	3	013	○	PO
	P4	10.8	10.85	POS012NL20	5P	200	26	-	50	8.5	6.5	9	3	013	○	
	P4	10.8	10.85	POS012NL12	5P	120	26	-	50	8.5	6.5	9	3	013	○	
	P5(P4+20)	10.8	10.85	POT012NL15	5P	150	26	-	50	8.5	6.5	9	3	013	○	ST
M12X1	P3	11	11.09	POR012ML10	5P	100	26	-	50	8.5	6.5	9	3	013	○	
	P3	11	11.09	POR012ML15	5P	150	26	-	50	8.5	6.5	9	3	013	○	
M14X1.5	P3	12.5	12.6	POR0140L15	5P	150	26	-	60	10.5	8	11	3	013	○	
	P3	12.5	12.6	POR0140L20	5P	200	26	-	60	10.5	8	11	3	013	○	ROLL
	P3	12.5	12.6	POR0140L12	5P	120	26	-	60	10.5	8	11	3	013	○	
	P4(P3+20)	12.5	12.6	POS0140L15	5P	150	26	-	60	10.5	8	11	3	013	○	
M16X1.5	P3	14.5	14.6	POR0160L15	5P	150	26	-	60	12.5	10	13	3	013	○	CARBIDE
	P3	14.5	14.6	POR0160L20	5P	200	26	-	60	12.5	10	13	3	013	○	
M18X2	P4	16	16.12	POS018QL20	5P	200	33	-	70	14	11	14	3	013	○	
M18X1.5	P4	16.5	16.6	POS0180L15	5P	150	33	-	70	14	11	14	3	013	○	
	P4	16.5	16.6	POS0180L20	5P	200	33	-	70	14	11	14	3	013	○	LONG
M20X2	P4	18	18.12	POS020QL20	5P	200	33	-	70	15	12	15	3	013	○	JIS
M20X1.5	P4	18.5	18.6	POS0200L15	5P	150	33	-	70	15	12	15	3	013	○	
	P4	18.5	18.6	POS0200L20	5P	200	33	-	70	15	12	15	3	013	○	HAND TAPS
M22X2	P4	20	20.12	POS022QL20	5P	200	33	-	70	17	13	16	3	013	○	
M22X1.5	P4	20.5	20.6	POS0220L15	5P	150	33	-	70	17	13	16	3	013	○	
	P4	20.5	20.6	POS0220L20	5P	200	33	-	70	17	13	16	3	013	○	
M24X2	P4	22	22.12	POS024QL20	5P	200	39	-	80	19	15	18	3	013	○	EG (STI)
M24X1.5	P4	22.5	22.6	POS0240L15	5P	150	39	-	80	19	15	18	3	013	○	
	P4	22.5	22.6	POS0240L20	5P	200	39	-	80	19	15	18	3	013	○	
M27X2	P4	25	25.12	POS027QL25	5P	250	39	-	80	20	15	18	4	013	○	SPECIAL THREADS, GAUGES
M27X1.5	P4	25.5	25.6	POS0270L20	5P	200	39	-	80	20	15	18	4	013	○	
	P4	25.5	25.6	POS0270L25	5P	250	39	-	80	20	15	18	4	013	○	
M30X3	P4	27	27.13	POS030SL25	5P	250	46	-	80	23	17	20	4	013	○	
M30X2	P4	28	28.12	POS030QL25	5P	250	46	-	80	23	17	20	4	013	○	THREAD MILLS
M30X1.5	P4	28.5	28.6	POS0300L20	5P	200	46	-	80	23	17	20	4	013	○	
	P4	28.5	28.6	POS0300L25	5P	250	46	-	80	23	17	20	4	013	○	
JIS																DIES
1/4-20UNC	P2	5.1	5.19	POFQU04NL10	5P	100	15	30	40	6	4.5	7	3	011	○	
	P2	5.1	5.19	POFQU04NL15	5P	150	15	30	40	6	4.5	7	3	011	○	CENTER DRILLS
5/16-18UNC	P3	6.6	6.65	PORU050L10	5P	100	19	-	50	6.2	5	8	3	013	○	
	P3	6.6	6.65	PORU050L15	5P	150	19	-	50	6.2	5	8	3	013	○	

Long Taps

Intro

UNC	TCTR (tolerance)	\varnothing (mm)	Hole \varnothing (mm)	Code	THCHT (chamfer)	LF (mm)	THL (mm)	LU (mm)	LS (mm)	DCON (mm)	K (mm)	LK (mm)	NOF	Type	Stock
-----	---------------------	-----------------------	----------------------------	------	--------------------	------------	-------------	------------	------------	--------------	-----------	------------	-----	------	-------

SP

JIS															
3/8-16UNC	P3	8	8.07	PORU06PL10	5P	100	23	-	50	7	5.5	8	3	013	○
	P3	8	8.07	PORU06PL15	5P	150	23	-	50	7	5.5	8	3	013	○
7/16-14UNC	P3	9.4	9.45	PORU07QL15	5P	150	26	-	50	8.5	6.5	9	3	013	○

SL

1/2-13UNC	P3	10.9	10.91	PORU08RL15	5P	150	26	-	60	10.5	8	11	3	013	○
	P3	10.9	10.91	PORU08RL20	5P	200	26	-	60	10.5	8	11	3	013	○
5/8-11UNC	P3	13.6	13.75	PORU10UL15	5P	150	26	-	60	12.5	10	13	3	013	○
	P3	13.6	13.75	PORU10UL20	5P	200	26	-	60	12.5	10	13	3	013	○

PO

3/4-10UNC	P4	16.6	16.7	POSU12VL15	5P	150	33	-	70	15	12	15	3	013	○
	P4	16.6	16.7	POSU12VL20	5P	200	33	-	70	15	12	15	3	013	○
7/8-9UNC	P4	19.6	19.61	POSU14WL20	5P	200	33	-	70	17	13	16	3	013	○

ST

1-8UNC	P4	22.3	22.45	POSU16XL20	5P	200	39	-	80	19	15	18	3	013	○
	P4	22.3	22.45	POSU16XL15	5P	150	39	-	80	19	15	18	3	013	○

ROLL

UNF	TCTR (tolerance)	\varnothing (mm)	Hole \varnothing (mm)	Code	THCHT (chamfer)	LF (mm)	THL (mm)	LU (mm)	LS (mm)	DCON (mm)	K (mm)	LK (mm)	NOF	Type	Stock
-----	---------------------	-----------------------	----------------------------	------	--------------------	------------	-------------	------------	------------	--------------	-----------	------------	-----	------	-------

CARBIDE

JIS															
-----	--	--	--	--	--	--	--	--	--	--	--	--	--	--	--

LONG

JIS

1/4-28UNF	P2	5.5	5.53	POFQU04KL10	5P	100	15	30	40	6	4.5	7	3	011	○
	P2	5.5	5.53	POFQU04KL15	5P	150	15	30	40	6	4.5	7	3	011	○
5/16-24UNF	P2	6.9	6.97	POQU05ML10	5P	100	19	-	50	6.2	5	8	3	013	○
	P2	6.9	6.97	POQU05ML15	5P	150	19	-	50	6.2	5	8	3	013	○
3/8-24UNF	P2	8.5	8.57	POQU06ML10	5P	100	23	-	50	7	5.5	8	3	013	○
	P2	8.5	8.57	POQU06ML15	5P	150	23	-	50	7	5.5	8	3	013	○
7/16-20UNF	P3	9.9	9.96	PORU07NL15	5P	150	26	-	50	8.5	6.5	9	3	013	○

HAND TAPS

1/2-20UNF	P3	11.5	11.54	PORU08NL15	5P	150	26	-	60	10.5	8	11	3	013	○
	P3	11.5	11.54	PORU08NL20	5P	200	26	-	60	10.5	8	11	3	013	○
5/8-18UNF	P3	14.5	14.6	PORU100L15	5P	150	26	-	60	12.5	10	13	3	013	○
	P3	14.5	14.6	PORU100L20	5P	200	26	-	60	12.5	10	13	3	013	○
3/4-16UNF	P3	17.5	17.59	PORU12PL15	5P	150	33	-	70	15	12	15	3	013	○
	P3	17.5	17.59	PORU12PL20	5P	200	33	-	70	15	12	15	3	013	○
7/8-14UNF	P3	20.5	20.57	PORU14QL20	5P	200	33	-	70	17	13	16	3	013	○

EG (STI)

BSW	TCTR (tolerance)	\varnothing (mm)	Hole \varnothing (mm)	Code	THCHT (chamfer)	LF (mm)	THL (mm)	LU (mm)	LS (mm)	DCON (mm)	K (mm)	LK (mm)	NOF	Type	Stock
-----	---------------------	-----------------------	----------------------------	------	--------------------	------------	-------------	------------	------------	--------------	-----------	------------	-----	------	-------

SPECIAL THREADS, GAUGES

THREAD MILLS

DIES

CENTER DRILLS

JIS															
1/4W20	P3	5.1	5.13	POFRW04NL10	5P	100	15	30	40	6	4.5	7	3	011	○
	P3	5.1	5.13	POFRW04NL15	5P	150	15	30	40	6	4.5	7	3	011	○
5/16W18	P3	6.5	6.59	PORW050L10	5P	100	19	-	50	6.2	5	8	3	013	○
	P3	6.5	6.59	PORW050L15	5P	150	19	-	50	6.2	5	8	3	013	○
3/8W16	P3	8	8.02	PORW06PL10	5P	100	23	-	50	7	5.5	8	3	013	○
	P3	8	8.02	PORW06PL15	5P	150	23	-	50	7	5.5	8	3	013	○
7/16W14	P3	9.3	9.39	PORW07QL15	5P	150	26	-	50	8.5	6.5	9	3	013	○
	P3	10.6	10.7	PORW08SL15	5P	150	26	-	60	10.5	8	11	3	013	○
1/2W12	P3	10.6	10.7	PORW08SL20	5P	200	26	-	60	10.5	8	11	3	013	○
	P3	13.5	13.68	PORW10UL15	5P	150	26	-	60	12.5	10	13	3	013	○
5/8W11	P3	13.5	13.68	PORW10UL20	5P	200	26	-	60	12.5	10	13	3	013	○
	P4	16.5	16.63	POSW12VL15	5P	150	33	-	70	15	12	15	3	013	○
3/4W10	P4	16.5	16.63	POSW12VL20	5P	200	33	-	70	15	12	15	3	013	○

Technical info

BSW	TCTR (tolerance)	 Hole Ø (mm)	Hole Ø (mm)	Code	THCHT (chamfer)	LF (mm)	THL (mm)	LU (mm)	LS (mm)	DCON (mm)	K (mm)	LK (mm)	NOF	Type	Stock
JIS															
7/8W9	P4	19.5	19.53	POSW14WL15	5P	150	33	-	70	17	13	16	3	013	○
	P4	19.5	19.53	POSW14WL20	5P	200	33	-	70	17	13	16	3	013	○
1 W8	P4	22.2	22.34	POSW16XL15	5P	150	39	-	80	19	15	18	3	013	○
	P4	22.2	22.34	POSW16XL20	5P	200	39	-	80	19	15	18	3	013	○

Intro

SP

SL

PO

ST

ROLL

CARBIDE

LONG

JISHAND
TAPS

EG (STI)

SPECIAL
THREADS,
GAUGESTHREAD
MILLS

DIES

CENTER
DRILLSTechnical
info

Intro

LS-PO-K

GP General Purpose Series

SP Long Shank Spiral Pointed Taps with Long Neck



SL



FEATURES

Long shank general purpose for extended overhang on through hole application.

For tapping steel, also suitable for non-ferrous materials.

Reduced neck for deep holes.

PO

Recommended Tapping Speeds Depending On Materials

ISO	Vc (m/min)	ISO	Vc (m/min)
P1	5÷10 ☆	N1	5÷10 ☆
P2	5÷10 ★	N2	5÷10 ☆
P3	5÷10 ☆	N3	5÷10 ☆
P4	5÷8 ☆	N4	5÷10 ☆

★ 1st choice ☆ suitable

ROLL

CARBIDE

LONG

JIS

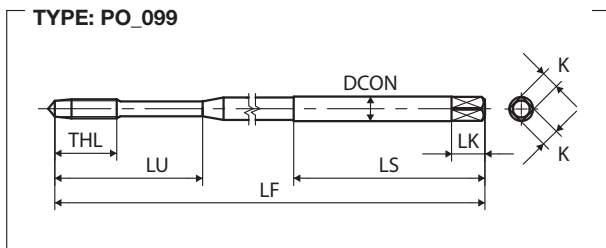

HAND TAPS

EG (STI)

SPECIAL THREADS, GAUGES

THREAD MILLS

DIES

CENTER DRILLS

Technical info

M	TCTR (tolerance)	∅ (mm)	Hole ∅ (mm)	Code	THCHT (chamfer)	LF (mm)	THL (mm)	LU (mm)	LS (mm)	DCON (mm)	K (mm)	LK (mm)	NOF	Type	Stock
JIS															
M3X0.5	P2	2.5	2.56	PY3.0GQFEBE	4.5P	100	9	28	40	4	3.2	6	3	099	○
	P2	2.5	2.56	PY3.0GQFEBF	4.5P	120	9	28	40	4	3.2	6	3	099	○
	P2	2.5	2.56	PY3.0GQFEBG	4.5P	150	9	28	40	4	3.2	6	3	099	○
M4X0.7	P2	3.3	3.38	PY4.0IQFEBE	4.5P	100	11	31	40	5	4	7	3	099	○
	P2	3.3	3.38	PY4.0IQFEBF	4.5P	120	11	31	40	5	4	7	3	099	○
	P2	3.3	3.38	PY4.0IQFEBG	4.5P	150	11	31	40	5	4	7	3	099	○
M5X0.8	P2	4.2	4.28	PY5.0KQFEBE	4.5P	100	13	38	40	5.5	4.5	7	3	099	○
	P2	4.2	4.28	PY5.0KQFEBF	4.5P	120	13	38	40	5.5	4.5	7	3	099	○
	P2	4.2	4.28	PY5.0KQFEBG	4.5P	150	13	38	40	5.5	4.5	7	3	099	○
M6X1	P2	5	5.09	PY6.0MQFEBE	4.5P	100	15	45	40	6	4.5	7	3	099	○
	P2	5	5.09	PY6.0MQFEBF	4.5P	120	15	45	40	6	4.5	7	3	099	○
	P2	5	5.09	PY6.0MQFEBG	4.5P	150	15	45	40	6	4.5	7	3	099	○

LS-PO V

GP General Purpose Series

Long Shank Spiral Pointed Taps, Coated



FEATURES

Long shank general purpose for extended overhang on through hole application.

For tapping steel, also suitable for stainless steel and non-ferrous materials.

Adopting suitable coating to improve performances.

Recommended Tapping Speeds Depending On Materials

ISO	Vc (m/min)	ISO	Vc (m/min)	ISO	Vc (m/min)
P1	10÷20 ★	M1	6÷12 ☆	N1	10÷20 ☆
P2	10÷20 ★	M2	5÷10 ☆	N2	10÷20 ☆
P3	10÷20 ★			N3	10÷20 ☆
P4	10÷15 ★			N4	10÷20 ☆
P7	6÷12 ☆				

★ 1st choice ☆ suitable

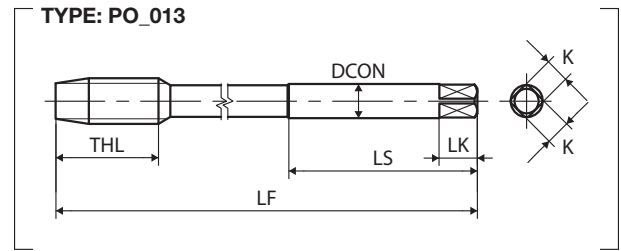
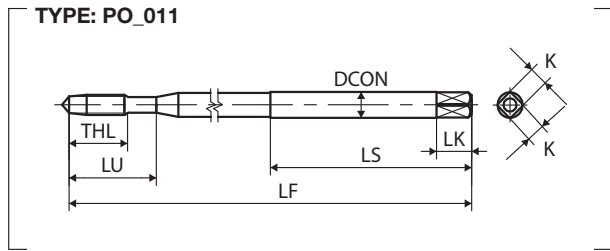

M	TCTR (tolerance)	∅ (mm)	Hole ∅ (mm)	Code	THCHT (chamfer)	LF (mm)	THL (mm)	LU (mm)	LS (mm)	DCON (mm)	K (mm)	LK (mm)	NOF	Type	Stock
JIS															
M3X0.5	P2	2.5	2.56	VPOFQ3.0GL10	5P	100	9	18	40	4	3.2	6	3	011	○
M4X0.7	P2	3.3	3.38	VPOFQ4.0IL10	5P	100	11	21	40	5	4	7	3	011	○
M5X0.8	P2	4.2	4.28	VPOFQ5.0KL10	5P	100	13	25	40	5.5	4.5	7	3	011	○
M6X1	P2	5	5.09	VPOFQ6.0ML10	5P	100	15	30	40	6	4.5	7	3	011	○
	P2	5	5.09	VPOFQ6.0ML15	5P	150	15	30	40	6	4.5	7	3	011	○
M8X1.25	P3	6.8	6.85	VPOR8.0NL10	5P	100	19	-	50	6.2	5	8	3	013	○
	P3	6.8	6.85	VPOR8.0NL15	5P	150	19	-	50	6.2	5	8	3	013	○
M10X1.5	P3	8.5	8.6	VPOR0100L15	5P	150	23	-	50	7	5.5	8	3	013	○
M12X1.75	P4	10.3	10.36	VPOS012PL15	5P	150	26	-	50	8.5	6.5	9	3	013	○
MF															
M	TCTR (tolerance)	∅ (mm)	Hole ∅ (mm)	Code	THCHT (chamfer)	LF (mm)	THL (mm)	LU (mm)	LS (mm)	DCON (mm)	K (mm)	LK (mm)	NOF	Type	Stock
JIS															
M10X1.25	P3	8.8	8.85	VPOR010NL15	5P	150	23	-	50	7	5.5	8	3	013	○
M12X1.5	P3	10.5	10.6	VPOR0120L15	5P	150	26	-	50	8.5	6.5	9	3	013	○
M12X1.25	P4	10.8	10.85	VPOS012NL15	5P	150	26	-	50	8.5	6.5	9	3	013	○

- Intro
- SP
- SL
- PO
- ST
- ROLL
- CARBIDE
- LONG JIS
- HAND TAPS
- EG (STI)
- SPECIAL THREADS, GAUGES
- THREAD MILLS
- DIES
- CENTER DRILLS
- Technical info

Intro

MC-PO



SP

GP General Purpose Series

Long Shank Spiral Pointed Taps with Radial Coolant Holes

SL



FEATURES

Long shank general purpose for extended overhang on through hole application.

For steel application, also suitable for non-ferrous materials.

With radial coolant holes.

PO

Recommended Tapping Speeds Depending On Materials

ISO	Vc (m/min)	ISO	Vc (m/min)
P1	5÷10 ☆	N1	5÷10 ☆
P2	5÷10 ★	N2	5÷10 ☆
P3	5÷10 ☆	N3	5÷10 ☆
P4	5÷8 ☆	N4	5÷10 ☆

★ 1st choice ☆ suitable

ROLL

CARBIDE

LONG

JIS

HAND TAPS

EG (STI)

SPECIAL THREADS, GAUGES

THREAD MILLS

DIES

CENTER DRILLS

Technical info

TYPE: PO_029

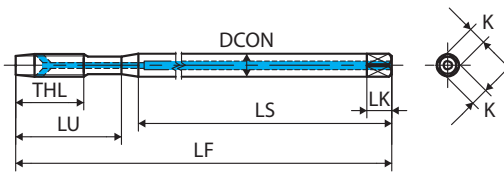

TYPE: PO_030

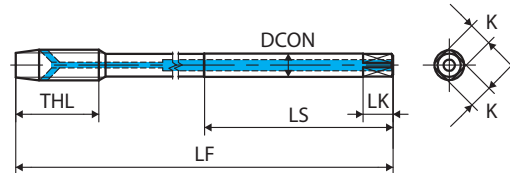

M	TCTR (tolerance)	Hole Ø (mm)	Hole Ø (mm)	Code	THCHT (chamfer)	LF (mm)	THL (mm)	LU (mm)	LS (mm)	DCON (mm)	K (mm)	LK (mm)	NOF	Type	Stock
JIS															
M6X1	P2	5	5.09	MPHQ6.0ML10	5P	100	19	28	40	6	4.5	7	3	029	○
	P2	5	5.09	MPHQ6.0ML15	5P	150	19	28	40	6	4.5	7	3	029	○
M8X1.25	P3	6.8	6.85	MPHR8.0NL10	5P	100	22	-	50	6.2	5	8	3	030	○
	P3	6.8	6.85	MPHR8.0NL15	5P	150	22	-	50	6.2	5	8	3	030	○
M10X1.5	P3	8.5	8.6	MPHR0100L10	5P	100	24	-	50	7	5.5	8	3	030	○
	P3	8.5	8.6	MPHR0100L15	5P	150	24	-	50	7	5.5	8	3	030	○
M12X1.75	P4	10.3	10.36	MPHS012PL10	5P	100	29	-	50	8.5	6.5	9	3	030	○
	P4	10.3	10.36	MPHS012PL15	5P	150	29	-	50	8.5	6.5	9	3	030	○
	P4	10.3	10.36	MPHS012PL20	5P	200	29	-	50	8.5	6.5	9	3	030	○
M14X2	P4	12	12.12	MPHS014QL15	5P	150	30	-	60	10.5	8	11	3	030	○
	P4	12	12.12	MPHS014QL20	5P	200	30	-	60	10.5	8	11	3	030	○
M16X2	P4	14	14.12	MPHS016QL15	5P	150	32	-	60	12.5	10	13	3	030	○
	P4	14	14.12	MPHS016QL20	5P	200	32	-	60	12.5	10	13	3	030	○
M18X2.5	P4	15.5	15.63	MPHS018RL15	5P	150	37	-	70	14	11	14	3	030	○
	P4	15.5	15.63	MPHS018RL20	5P	200	37	-	70	14	11	14	3	030	○

M	TCTR (tolerance)	 Hole Ø (mm)	Hole Ø (mm)	Code	THCHT (chamfer)	LF (mm)	THL (mm)	LU (mm)	LS (mm)	DCON (mm)	K (mm)	LK (mm)	NOF	Type	Stock
JIS															
M20X2.5	P4	17.5	17.63	MPHS020RL15	5P	150	37	-	70	15	12	15	3	030	○
	P4	17.5	17.63	MPHS020RL20	5P	200	37	-	70	15	12	15	3	030	○
M22X2.5	P4	19.5	19.63	MPHS022RL15	5P	150	38	-	70	17	13	16	3	030	○
	P4	19.5	19.63	MPHS022RL20	5P	200	38	-	70	17	13	16	3	030	○
M24X3	P4	21	21.13	MPHS024SL15	5P	150	45	-	80	19	15	18	3	030	○
	P4	21	21.13	MPHS024SL20	5P	200	45	-	80	19	15	18	3	030	○
M27X3	P4	24	24.13	MPHS027SL20	5P	200	45	-	80	20	15	18	4	030	○
	P4	24	24.13	MPHS027SL25	5P	250	45	-	80	20	15	18	4	030	○
M30X3.5	P5	26.5	26.63	MPHT030TL20	5P	200	48	-	80	23	17	20	4	030	○
	P5	26.5	26.63	MPHT030TL25	5P	250	48	-	80	23	17	20	4	030	○
JIS															
M10X1.25	P3	8.8	8.85	MPHR010NL15	5P	150	24	-	50	7	5.5	8	3	030	○
	P3	8.8	8.85	MPHR010NL10	5P	100	24	-	50	7	5.5	8	3	030	○
M12X1.5	P3	10.5	10.6	MPHR0120L10	5P	100	29	-	50	8.5	6.5	9	3	030	○
	P3	10.5	10.6	MPHR0120L15	5P	150	29	-	50	8.5	6.5	9	3	030	○
M12X1.25	P4	10.8	10.85	MPHS012NL10	5P	100	29	-	50	8.5	6.5	9	3	030	○
	P4	10.8	10.85	MPHS012NL15	5P	150	29	-	50	8.5	6.5	9	3	030	○
M14X1.5	P3	12.5	12.6	MPHR0140L15	5P	150	30	-	60	10.5	8	11	3	030	○
	P3	12.5	12.6	MPHR0140L20	5P	200	30	-	60	10.5	8	11	3	030	○
M16X1.5	P3	14.5	14.6	MPHR0160L15	5P	150	32	-	60	12.5	10	13	3	030	○
	P3	14.5	14.6	MPHR0160L20	5P	200	32	-	60	12.5	10	13	3	030	○
M18X1.5	P4	16.5	16.6	MPHS0180L15	5P	150	37	-	70	14	11	14	3	030	○
	P4	16.5	16.6	MPHS0180L20	5P	200	29	-	70	14	11	14	3	030	○
M20X1.5	P4	18.5	18.6	MPHS0200L15	5P	150	37	-	70	15	12	15	3	030	○
	P4	18.5	18.6	MPHS0200L20	5P	200	29	-	70	15	12	15	3	030	○
M22X1.5	P4	20.5	20.6	MPHS0220L15	5P	150	33	-	70	17	13	16	3	030	○
	P4	20.5	20.6	MPHS0220L20	5P	200	33	-	70	17	13	16	3	030	○
M24X1.5	P4	22.5	22.6	MPHS0240L15	5P	150	35	-	80	19	15	18	3	030	○
	P4	22.5	22.6	MPHS0240L20	5P	200	35	-	80	19	15	18	3	030	○
M27X1.5	P4	25.5	25.6	MPHS0270L20	5P	200	37	-	80	20	15	18	4	030	○
	P4	25.5	25.6	MPHS0270L25	5P	250	37	-	80	20	15	18	4	030	○
M30X1.5	P4	28.5	28.6	MPHS0300L20	5P	200	37	-	80	23	17	20	4	030	○
	P4	28.5	28.6	MPHS0300L25	5P	250	37	-	80	23	17	20	4	030	○

Intro

SP

SL

PO

ST

ROLL

CARBIDE

LONG

JIS

HAND

TAPS

EG (STI)

SPECIAL
THREADS,
GAUGESTHREAD
MILLS

DIES

CENTER
DRILLSTechnical
info

Intro

LS-PM-PO



SP

MS Material Specific Series

Long Shank Spiral Pointed Taps for Hard Materials (<45HRC)

SL



PO

Recommended Tapping Speeds Depending On Materials

ISO	Vc (m/min)	
P3	2÷10	★
P4	2÷7	★
P5	2÷7	★
P6	2÷5	★

★ 1st choice ☆ suitable

ST

ROLL

CARBIDE

LONG

JIS

HAND TAPS

EG (STI)

SPECIAL THREADS, GAUGES

THREAD MILLS

DIES

CENTER DRILLS

Technical info

FEATURES

Long shank material specific for extended overhang on through hole application.

Specific design and high class HSSP for stable and long life on alloy steel and tool steel (30 ÷ 45HRC) application.

Reliable and high performance tapping for the mould&die industry.

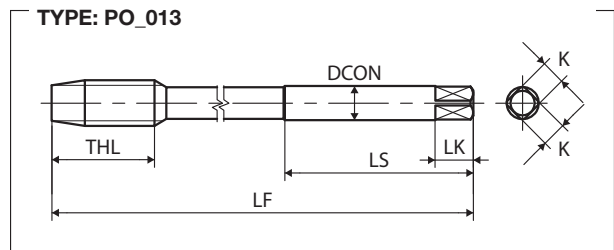
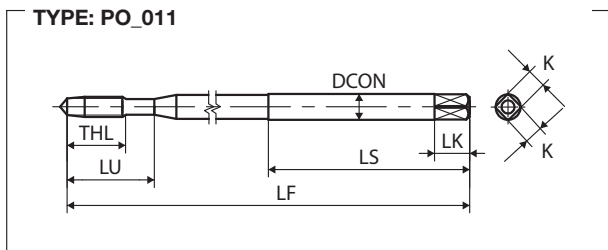

M	TCTR (tolerance)	∅ (mm)	Hole ∅ (mm)	Code	THCHT (chamfer)	LF (mm)	THL (mm)	LU (mm)	LS (mm)	DCON (mm)	K (mm)	LK (mm)	NOF	Type	Stock
JIS															
M3X0.5	P3	2.5	2.56	P43.0GRDPBE	5.5P	100	9	18	40	4	3.2	6	3	011	○
M4X0.7	P3	3.3	3.38	P44.0IRDPE	5.5P	100	11	21	40	5	4	7	3	011	○
M5X0.8	P3	4.2	4.28	P45.0KRDPE	5.5P	100	13	25	40	5.5	4.5	7	3	011	○
M6X1	P3	5	5.09	P46.0MRDPE	5.5P	100	15	30	40	6	4.5	7	3	011	○
	P3	5	5.09	P46.0MRDPEBG	5.5P	150	15	30	40	6	4.5	7	3	011	○
M8X1.25	P4	6.8	6.85	PY8.0NSDPE	5.5P	100	19	-	50	6.2	5	8	3	013	○
	P4	6.8	6.85	PY8.0NSDPEBG	5.5P	150	19	-	50	6.2	5	8	3	013	○
M10X1.5	P4	8.5	8.6	PY0100SDPEBG	5.5P	150	23	-	50	7	5.5	8	3	013	○
M12X1.75	P4	10.3	10.36	PY012PSDPEBG	5.5P	150	26	-	50	8.5	6.5	9	3	013	○
M14X2	P5	12	12.12	PY014QTDPEBG	5.5P	150	26	-	60	10.5	8	11	3	013	○
M16X2	P5	14	14.12	PY016QTDPEBG	5.5P	150	26	-	60	12.5	10	13	3	013	○
M18X2.5	P5	15.5	15.63	PY018RTDPEBG	5.5P	150	33	-	70	14	11	14	3	013	○
M20X2.5	P5	17.5	17.63	PY020RTDPEBG	5.5P	150	33	-	70	15	12	15	3	013	○
M22X2.5	P5	19.5	19.63	PY022RTDPEBK	5.5P	200	33	-	70	17	13	16	3	013	○
M24X3	P5	21	21.13	PY024STDPEBK	5.5P	200	39	-	80	19	15	18	3	013	○
M27X3	P5	24	24.13	PY027STDPEBK	5.5P	200	39	-	80	20	15	18	4	013	○
M30X3.5	P5	26.5	26.63	PY030TTDPEBK	5.5P	200	46	-	80	23	17	20	4	013	○

MF	TCTR (tolerance)	∅ (mm)	Hole ∅ (mm)	Code	THCHT (chamfer)	LF (mm)	THL (mm)	LU (mm)	LS (mm)	DCON (mm)	K (mm)	LK (mm)	NOF	Type	Stock
JIS															
M10X1.25	P4	8.8	8.85	PY010NSDPEBG	5.5P	150	23	-	50	7	5.5	8	3	013	○
M12X1.5	P4	10.5	10.6	PY0120SDPEBG	5.5P	150	26	-	50	8.5	6.5	9	3	013	○
M12X1.25	P4	10.8	10.85	PY012NSDPEBG	5.5P	150	26	-	50	8.5	6.5	9	3	013	○
M14X1.5	P4	12.5	12.6	PY0140SDPEBG	5.5P	150	26	-	60	10.5	8	11	3	013	○
M16X1.5	P4	14.5	14.6	PY0160SDPEBG	5.5P	150	26	-	60	12.5	10	13	3	013	○
M18X1.5	P4	16.5	16.6	PY0180SDPEBG	5.5P	150	33	-	70	14	11	14	3	013	○
M20X1.5	P4	18.5	18.6	PY0200SDPEBG	5.5P	150	33	-	70	15	12	15	3	013	○
M22X1.5	P4	20.5	20.6	PY0220SDPEBK	5.5P	200	33	-	70	17	13	16	3	013	○
M24X1.5	P4	22.5	22.6	PY0240SDPEBK	5.5P	200	39	-	80	19	15	18	3	013	○
M27X1.5	P4	25.5	25.6	PY0270SDPEBK	5.5P	200	39	-	80	20	15	18	4	013	○
M30X1.5	P4	28.5	28.6	PY0300SDPEBK	5.5P	200	46	-	80	23	17	20	4	013	○

Intro

SP

SL

PO

ST

ROLL

CARBIDE

LONG
JIS

HAND
TAPS

EG (STI)

SPECIAL
THREADS,
GAUGES

THREAD
MILLS

DIES

CENTER
DRILLS

Technical
info

Intro

LS-SU-S-PO

MS Material Specific Series

SP Long Shank Spiral Pointed Taps for Stainless Steel

SL

HSS-E

OX

4.5P
THCHT

5P
THCHT

Recommended Tapping Speeds Depending On Materials

ISO	Vc (m/min)	★	ISO	Vc (m/min)	★
P1	≤10	★	M1	≤10	★
P2	≤10	★	M2	≤10	★
P3	≤10	★			
P4	≤10	☆			
P7	≤10	★			

★ 1st choice ☆ suitable

ROLL

CARBIDE

LONG
JIS

HAND
TAPS

EG (STI)

SPECIAL
THREADS,
GAUGES

THREAD
MILLS

DIES

CENTER
DRILLS

Technical
info



FEATURES

Long shank for extended overhang on through hole application.

Material specific for stainless steel and steel application.

With OX treatment to reduce welding troubles.

TYPE: PO_011

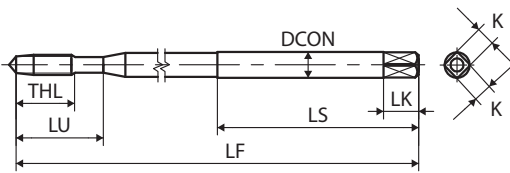

TYPE: PO_013

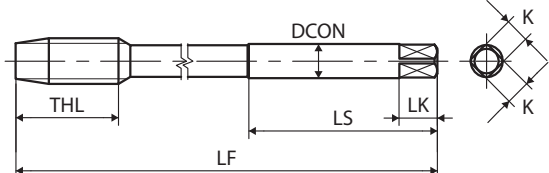

M	TCTR (tolerance)	∅ (mm)	Hole ∅ (mm)	Code	THCHT (chamfer)	LF (mm)	THL (mm)	LU (mm)	LS (mm)	DCON (mm)	K (mm)	LK (mm)	NOF	Type	Stock
JIS															
M3X0.5	P2	2.5	2.56	PY3.0QGEXES	4.5P	100	9	28	40	4	3.2	6	3	011	●
M4X0.7	P2	3.3	3.38	PY4.0IQGEXES	4.5P	100	11	31	40	5	4	7	3	011	●
	P2	3.3	3.38	PY4.0IQGEXGS	4.5P	150	11	31	40	5	4	7	3	011	●
M5X0.8	P2	4.2	4.28	PY5.0KQGEXES	4.5P	100	13	38	40	5.5	4.5	7	3	011	●
	P2	4.2	4.28	PY5.0KQGEXGS	4.5P	150	13	38	40	5.5	4.5	7	3	011	●
M6X1	P2	5	5.09	PY6.0MQGEXES	4.5P	100	15	45	40	6	4.5	7	3	011	●
	P2	5	5.09	PY6.0MQGEXGS	4.5P	150	15	45	40	6	4.5	7	3	011	●
M8X1.25	P3	6.8	6.85	PY8.0NRGEXES	5P	100	12	-	50	6.2	5	8	3	013	○
	P3	6.8	6.85	PY8.0NRGEXGS	5P	150	12	-	50	6.2	5	8	3	013	●
M10X1.5	P3	8.5	8.6	PY0100RGEXES	5P	100	13	-	50	7	5.5	8	3	013	○
	P3	8.5	8.6	PY0100RGEXGS	5P	150	13	-	50	7	5.5	8	3	013	●
M12X1.75	P4	10.3	10.36	PY012PSGEXES	5P	100	15	-	50	8.5	6.5	9	3	013	○
	P4	10.3	10.36	PY012PSGEXGS	5P	150	15	-	50	8.5	6.5	9	3	013	●
M14X2	P4	12	12.12	PY014QSGEXGS	5P	150	18	-	60	10.5	8	11	3	013	○
M16X2	P4	14	14.12	PY016QSGEXGS	5P	150	18	-	60	12.5	10	13	3	013	○
	P4	14	14.12	PY016QSGEXKS	5P	200	18	-	60	12.5	10	13	3	013	○
M18X2.5	P4	15.5	15.63	PY018RSGEXKS	5P	200	20	-	70	14	11	14	3	013	○
M20X2.5	P4	17.5	17.63	PY020RSGEXGS	5P	150	20	-	70	15	12	15	3	013	○
	P4	17.5	17.63	PY020RSGEXKS	5P	200	20	-	70	15	12	15	3	013	○
M22X2.5	P4	19.5	19.63	PY022RSGEXKS	5P	200	20	-	70	17	13	16	3	013	○
M24X3	P4	21	21.13	PY024SSGEXKS	5P	200	25	-	80	19	15	18	3	013	○
MF															
JIS															
M10X1.25	P3	8.8	8.85	PY010NRGEXGS	5P	150	13	-	50	7	5.5	8	3	013	○
M12X1.5	P3	10.5	10.6	PY0120RGEXGS	5P	150	15	-	50	8.5	6.5	9	3	013	○
M12X1.25	P4	10.8	10.85	PY012NSGEXGS	5P	150	15	-	50	8.5	6.5	9	3	013	○
M14X1.5	P3	12.5	12.6	PY0140RGEXGS	5P	150	14	-	60	10.5	8	11	3	013	○
M16X1.5	P3	14.5	14.6	PY0160RGEXGS	5P	150	14	-	60	12.5	10	13	3	013	○
	P3	14.5	14.6	PY0160RGEXKS	5P	200	14	-	60	12.5	10	13	3	013	○
M18X1.5	P4	16.5	16.6	PY0180SGEXKS	5P	200	14	-	70	14	11	14	3	013	○
M20X1.5	P4	18.5	18.6	PY0200SGEXGS	5P	150	14	-	70	15	12	15	3	013	○
	P4	18.5	18.6	PY0200SGEXKS	5P	200	14	-	70	15	12	15	3	013	○
M22X1.5	P4	20.5	20.6	PY0220SGEXKS	5P	200	14	-	70	17	13	16	3	013	○
M24X1.5	P4	22.5	22.6	PY0240SGEXKS	5P	200	18	-	80	19	15	18	3	013	○

Intro

SP

SL

PO

ST

ROLL

CARBIDE

LONG

JIS

HAND
TAPS

EG (STI)

SPECIAL
THREADS,
GAUGESTHREAD
MILLS

DIES

CENTER
DRILLSTechnical
info

Intro

LS-HT

GP General Purpose Series

SP

Long Shank Straight Fluted Taps

SL



PO

Recommended Tapping Speeds Depending On Materials

ISO	Vc (m/min)	ISO	Vc (m/min)	ISO	Vc (m/min)
P1	5÷10 ☆	K1	5÷10 ☆	N2	5÷10 ☆
P2	5÷10 ★	K2	5÷10 ☆	N3	5÷10 ☆
P3	5÷10 ☆	K3	5÷10 ☆	N4	5÷10 ☆
P4	5÷10 ☆				

★ 1st choice ☆ suitable

ROLL

CARBIDE

LONG

JIS

HAND TAPS

EG (STI)

SPECIAL THREADS, GAUGES

THREAD MILLS

DIES

CENTER DRILLS

Technical info



FEATURES

Long shank general purpose for extended overhang on blind and through hole application.

For steel application at low cutting speed, also suitable for cast iron and non-ferrous materials.

TYPE: HT_011

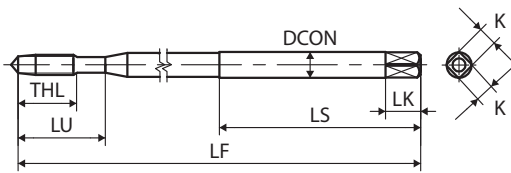

TYPE: HT_013

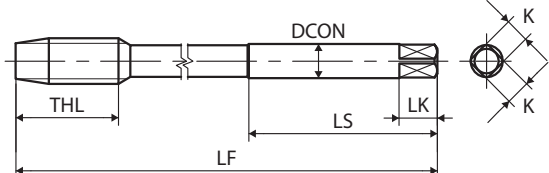

M	TCTR (tolerance)	 Hole Ø (mm)	Hole Ø (mm)	Code	THCHT (chamfer)	LF (mm)	THL (mm)	LU (mm)	LS (mm)	DCON (mm)	K (mm)	LK (mm)	NOF	Type	Stock
JIS															
M2X0.4	P1	1.6	1.65	TNFP2.0E507	5P	70	7.2	15	52	3	2.5	5	3	011	○
	P1	1.6	1.65	TNFP2.0E107	1.5P	70	7.2	15	52	3	2.5	5	3	011	○
M2.3X0.4	P1	1.9	1.95	TNFP2.3E507	5P	70	7.2	15	52	3	2.5	5	3	011	○
	P1	1.9	1.95	TNFP2.3E107	1.5P	70	7.2	15	52	3	2.5	5	3	011	○
M2.5X0.45	P1	2.1	2.11	TNFP2.5F507	5P	70	8.1	15	52	3	2.5	5	3	011	○
	P1	2.1	2.11	TNFP2.5F107	1.5P	70	8.1	15	52	3	2.5	5	3	011	○
M2.6X0.45	P1	2.2	2.21	TNFP2.6F507	5P	70	8.1	15	52	3	2.5	5	3	011	○
	P1	2.2	2.21	TNFP2.6F107	1.5P	70	8.1	15	52	3	2.5	5	3	011	○
M3X0.5	P1	2.5	2.56	TNFP3.0G507	5P	70	9	18	46	4	3.2	6	3	011	○
	P1	2.5	2.56	TNFP3.0G510	5P	100	9	18	40	4	3.2	6	3	011	○
	P1	2.5	2.56	TNFP3.0G512	5P	120	9	18	40	4	3.2	6	3	011	○
	P1	2.5	2.56	TNFP3.0G515	5P	150	9	18	40	4	3.2	6	3	011	○
	P1	2.5	2.56	TNFP3.0G107	1.5P	70	9	18	46	4	3.2	6	3	011	○
	P1	2.5	2.56	TNFP3.0G110	1.5P	100	9	18	40	4	3.2	6	3	011	○
	P1	2.5	2.56	TNFP3.0G112	1.5P	120	9	18	40	4	3.2	6	3	011	○
	P1	2.5	2.56	TNFP3.0G115	1.5P	150	9	18	40	4	3.2	6	3	011	○
	P3(P1+30)	2.5	2.56	TNFR3.0G510	5P	100	9	18	40	4	3.2	6	3	011	○
	P3(P1+30)	2.5	2.56	TNFR3.0G515	5P	150	9	18	40	4	3.2	6	3	011	○
	P3(P1+30)	2.5	2.56	TNFR3.0G110	1.5P	100	9	18	40	4	3.2	6	3	011	○
	P3(P1+30)	2.5	2.56	TNFR3.0G115	1.5P	150	9	18	40	4	3.2	6	3	011	○
M4X0.7	P2	3.3	3.38	TNFQ4.0I507	5P	70	11	21	43	5	4	7	3	011	○
	P2	3.3	3.38	TNFQ4.0I510	5P	100	11	21	40	5	4	7	3	011	○
	P2	3.3	3.38	TNFQ4.0I512	5P	120	11	21	40	5	4	7	3	011	○
	P2	3.3	3.38	TNFQ4.0I515	5P	150	11	21	40	5	4	7	3	011	○
	P2	3.3	3.38	TNFQ4.0I107	1.5P	70	11	21	47	5	4	7	3	011	○
	P2	3.3	3.38	TNFQ4.0I110	1.5P	100	11	21	40	5	4	7	3	011	○
	P2	3.3	3.38	TNFQ4.0I112	1.5P	120	11	21	40	5	4	7	3	011	○
	P2	3.3	3.38	TNFQ4.0I115	1.5P	150	11	21	40	5	4	7	3	011	○
	P3(P2+20)	3.3	3.38	TNFR4.0I510	5P	100	11	21	40	5	4	7	3	011	○
	P3(P2+20)	3.3	3.38	TNFR4.0I515	5P	150	11	21	40	5	4	7	3	011	○
	P3(P2+20)	3.3	3.38	TNFR4.0I110	1.5P	100	11	21	40	5	4	7	3	011	○
	P3(P2+20)	3.3	3.38	TNFR4.0I115	1.5P	150	11	21	40	5	4	7	3	011	○
M5X0.8	P2	4.2	4.28	TNFQ5.0K510	5P	100	13	25	40	5.5	4.5	7	3	011	○
	P2	4.2	4.28	TNFQ5.0K512	5P	120	13	25	40	5.5	4.5	7	3	011	○
	P2	4.2	4.28	TNFQ5.0K515	5P	150	13	25	40	5.5	4.5	7	3	011	○
	P2	4.2	4.28	TNFQ5.0K110	1.5P	100	13	25	40	5.5	4.5	7	3	011	○
	P2	4.2	4.28	TNFQ5.0K112	1.5P	120	13	25	40	5.5	4.5	7	3	011	○
	P2	4.2	4.28	TNFQ5.0K115	1.5P	150	13	25	40	5.5	4.5	7	3	011	○
	P3(P2+20)	4.2	4.28	TNFR5.0K510	5P	100	13	25	40	5.5	4.5	7	3	011	○
	P3(P2+20)	4.2	4.28	TNFR5.0K515	5P	150	13	25	40	5.5	4.5	7	3	011	○
	P3(P2+20)	4.2	4.28	TNFR5.0K110	1.5P	100	13	25	40	5.5	4.5	7	3	011	○
	P3(P2+20)	4.2	4.28	TNFR5.0K115	1.5P	150	13	25	40	5.5	4.5	7	3	011	○

Intro

SP

SL

PO

ST

ROLL

CARBIDE

LONG

JIS

HAND
TAPS

EG (STI)

SPECIAL
THREADS,
GAUGESTHREAD
MILLS

DIES

CENTER
DRILLSTechnical
info

Long Taps

Intro

SP

SL

PO

ST

ROLL

CARBIDE

LONG

JIS

HAND TAPS

EG (STI)

SPECIAL THREADS, GAUGES

THREAD MILLS

DIES

CENTER DRILLS

Technical info

M	TCTR (tolerance)	\varnothing (mm)	Hole \varnothing (mm)	Code	THCHT (chamfer)	LF (mm)	THL (mm)	LU (mm)	LS (mm)	DCON (mm)	K (mm)	LK (mm)	NOF	Type	Stock
JIS															
M6X1	P2	5	5.09	TNFQ6.0M510	5P	100	15	30	40	6	4.5	7	3	011	○
	P2	5	5.09	TNFQ6.0M512	5P	120	15	30	40	6	4.5	7	3	011	○
	P2	5	5.09	TNFQ6.0M515	5P	150	15	30	40	6	4.5	7	3	011	○
	P2	5	5.09	TNFQ6.0M520	5P	200	15	30	40	6	4.5	7	3	011	○
	P2	5	5.09	TNFQ6.0M110	1.5P	100	15	30	40	6	4.5	7	3	011	○
	P2	5	5.09	TNFQ6.0M112	1.5P	120	15	30	40	6	4.5	7	3	011	○
	P2	5	5.09	TNFQ6.0M115	1.5P	150	15	30	40	6	4.5	7	3	011	○
	P2	5	5.09	TNFQ6.0M120	1.5P	200	15	30	40	6	4.5	7	3	011	○
	P3(P2+20)	5	5.09	TNFR6.0M510	5P	100	15	30	40	6	4.5	7	3	011	○
	P3(P2+20)	5	5.09	TNFR6.0M515	5P	150	15	30	40	6	4.5	7	3	011	○
	P3(P2+20)	5	5.09	TNFR6.0M110	1.5P	100	15	30	40	6	4.5	7	3	011	○
	P3(P2+20)	5	5.09	TNFR6.0M115	1.5P	150	15	30	40	6	4.5	7	3	011	○
M8X1.25	P2	6.8	6.85	TNMQ8.0N510	5P	100	19	-	50	6.2	5	8	4	013	○
	P2	6.8	6.85	TNMQ8.0N512	5P	120	19	-	50	6.2	5	8	4	013	○
	P2	6.8	6.85	TNMQ8.0N515	5P	150	19	-	50	6.2	5	8	4	013	○
	P2	6.8	6.85	TNMQ8.0N520	5P	200	19	-	50	6.2	5	8	4	013	○
	P2	6.8	6.85	TNMQ8.0N110	1.5P	100	19	-	50	6.2	5	8	4	013	○
	P2	6.8	6.85	TNMQ8.0N112	1.5P	120	19	-	50	6.2	5	8	4	013	○
	P2	6.8	6.85	TNMQ8.0N115	1.5P	150	19	-	50	6.2	5	8	4	013	○
	P2	6.8	6.85	TNMQ8.0N120	1.5P	200	19	-	50	6.2	5	8	4	013	○
	P3(P2+20)	6.8	6.85	TNMR8.0N510	5P	100	19	-	50	6.2	5	8	4	013	○
	P3(P2+20)	6.8	6.85	TNMR8.0N515	5P	150	19	-	50	6.2	5	8	4	013	○
	P3(P2+20)	6.8	6.85	TNMR8.0N520	5P	200	19	-	50	6.2	5	8	4	013	○
	P3(P2+20)	6.8	6.85	TNMR8.0N110	1.5P	100	19	-	50	6.2	5	8	4	013	○
P3(P2+20)	6.8	6.85	TNMR8.0N115	1.5P	150	19	-	50	6.2	5	8	4	013	○	
P3(P2+20)	6.8	6.85	TNMR8.0N120	1.5P	200	19	-	50	6.2	5	8	4	013	○	
M10X1.5	P2	8.5	8.6	TNMQ0100510	5P	100	23	-	50	7	5.5	8	4	013	○
	P2	8.5	8.6	TNMQ0100512	5P	120	23	-	50	7	5.5	8	4	013	○
	P2	8.5	8.6	TNMQ0100515	5P	150	23	-	50	7	5.5	8	4	013	○
	P2	8.5	8.6	TNMQ0100520	5P	200	23	-	50	7	5.5	8	4	013	○
	P2	8.5	8.6	TNMQ0100525	5P	250	23	-	50	7	5.5	8	4	013	○
	P2	8.5	8.6	TNMQ0100110	1.5P	100	23	-	50	7	5.5	8	4	013	○
	P2	8.5	8.6	TNMQ0100112	1.5P	120	23	-	50	7	5.5	8	4	013	○
	P2	8.5	8.6	TNMQ0100115	1.5P	150	23	-	50	7	5.5	8	4	013	○
	P2	8.5	8.6	TNMQ0100120	1.5P	200	23	-	50	7	5.5	8	4	013	○
	P2	8.5	8.6	TNMQ0100125	1.5P	250	23	-	50	7	5.5	8	4	013	○
	P3(P2+20)	8.5	8.6	TNMR0100510	5P	100	23	-	50	7	5.5	8	4	013	○
	P3(P2+20)	8.5	8.6	TNMR0100515	5P	150	23	-	50	7	5.5	8	4	013	○
P3(P2+20)	8.5	8.6	TNMR0100110	1.5P	100	23	-	50	7	5.5	8	4	013	○	
P3(P2+20)	8.5	8.6	TNMR0100115	1.5P	150	23	-	50	7	5.5	8	4	013	○	
P4(P2+40)	8.5	8.6	TNMS0100510	5P	100	23	-	50	7	5.5	8	4	013	○	
P4(P2+40)	8.5	8.6	TNMS0100515	5P	150	23	-	50	7	5.5	8	4	013	○	
P4(P2+40)	8.5	8.6	TNMS0100110	1.5P	100	23	-	50	7	5.5	8	4	013	○	
P4(P2+40)	8.5	8.6	TNMS0100115	1.5P	150	23	-	50	7	5.5	8	4	013	○	
P3(P2+20)	8.5	8.6	TNMR0100520	5P	200	23	-	50	7	5.5	8	4	013	○	
P3(P2+20)	8.5	8.6	TNMR0100120	1.5P	200	23	-	50	7	5.5	8	4	013	○	

M	TCTR (tolerance)	 Hole Ø (mm)	Hole Ø (mm)	Code	THCHT (chamfer)	LF (mm)	THL (mm)	LU (mm)	LS (mm)	DCON (mm)	K (mm)	LK (mm)	NOF	Type	Stock
M12X1.75	P2	10.3	10.36	TNMQ012P510	5P	100	26	-	50	8.5	6.5	9	4	013	○
	P2	10.3	10.36	TNMQ012P512	5P	120	26	-	50	8.5	6.5	9	4	013	○
	P2	10.3	10.36	TNMQ012P515	5P	150	26	-	50	8.5	6.5	9	4	013	○
	P2	10.3	10.36	TNMQ012P520	5P	200	26	-	50	8.5	6.5	9	4	013	○
	P2	10.3	10.36	TNMQ012P525	5P	250	26	-	50	8.5	6.5	9	4	013	○
	P2	10.3	10.36	TNMQ012P110	1.5P	100	26	-	50	8.5	6.5	9	4	013	○
	P2	10.3	10.36	TNMQ012P112	1.5P	120	26	-	50	8.5	6.5	9	4	013	○
	P2	10.3	10.36	TNMQ012P115	1.5P	150	26	-	50	8.5	6.5	9	4	013	○
	P2	10.3	10.36	TNMQ012P120	1.5P	200	26	-	50	8.5	6.5	9	4	013	○
	P2	10.3	10.36	TNMQ012P125	1.5P	250	26	-	50	8.5	6.5	9	4	013	○
	P3(P2+20)	10.3	10.36	TNMR012P515	5P	150	26	-	50	8.5	6.5	9	4	013	○
	P3(P2+20)	10.3	10.36	TNMR012P115	1.5P	150	26	-	50	8.5	6.5	9	4	013	○
	P4(P2+40)	10.3	10.36	TNMS012P515	5P	150	26	-	50	8.5	6.5	9	4	013	○
	P4(P2+40)	10.3	10.36	TNMS012P520	5P	200	26	-	50	8.5	6.5	9	4	013	○
	P4(P2+40)	10.3	10.36	TNMS012P115	1.5P	150	26	-	50	8.5	6.5	9	4	013	○
	P4(P2+40)	10.3	10.36	TNMS012P120	1.5P	200	26	-	50	8.5	6.5	9	4	013	○
	P3(P2+20)	10.3	10.36	TNMR012P520	5P	200	26	-	50	8.5	6.5	9	4	013	○
P3(P2+20)	10.3	10.36	TNMR012P120	1.5P	200	26	-	50	8.5	6.5	9	4	013	○	
M14X2	P2	12	12.12	TNMQ014Q512	5P	120	26	-	60	10.5	8	11	4	013	○
	P2	12	12.12	TNMQ014Q515	5P	150	26	-	60	10.5	8	11	4	013	○
	P2	12	12.12	TNMQ014Q520	5P	200	26	-	60	10.5	8	11	4	013	○
	P2	12	12.12	TNMQ014Q525	5P	250	26	-	60	10.5	8	11	4	013	○
	P2	12	12.12	TNMQ014Q112	1.5P	120	26	-	60	10.5	8	11	4	013	○
	P2	12	12.12	TNMQ014Q115	1.5P	150	26	-	60	10.5	8	11	4	013	○
	P2	12	12.12	TNMQ014Q120	1.5P	200	26	-	60	10.5	8	11	4	013	○
	P2	12	12.12	TNMQ014Q125	1.5P	250	26	-	60	10.5	8	11	4	013	○
	P3(P2+20)	12	12.12	TNMR014Q515	5P	150	26	-	60	10.5	8	11	4	013	○
	P3(P2+20)	12	12.12	TNMR014Q115	1.5P	150	26	-	60	10.5	8	11	4	013	○
	P3(P2+20)	12	12.12	TNMR014Q520	5P	200	26	-	60	10.5	8	11	4	013	○
P3(P2+20)	12	12.12	TNMR014Q120	1.5P	200	26	-	60	10.5	8	11	4	013	○	
M16X2	P2	14	14.12	TNMQ016Q515	5P	150	26	-	60	12.5	10	13	4	013	○
	P2	14	14.12	TNMQ016Q520	5P	200	26	-	60	12.5	10	13	4	013	○
	P2	14	14.12	TNMQ016Q525	5P	250	26	-	60	12.5	10	13	4	013	○
	P2	14	14.12	TNMQ016Q115	1.5P	150	26	-	60	12.5	10	13	4	013	○
	P2	14	14.12	TNMQ016Q120	1.5P	200	26	-	60	12.5	10	13	4	013	○
	P2	14	14.12	TNMQ016Q125	1.5P	250	26	-	60	12.5	10	13	4	013	○
	P3(P2+20)	14	14.12	TNMR016Q515	5P	150	26	-	60	12.5	10	13	4	013	○
	P3(P2+20)	14	14.12	TNMR016Q115	1.5P	150	26	-	60	12.5	10	13	4	013	○
	P3(P2+20)	14	14.12	TNMR016Q520	5P	200	26	-	60	12.5	10	13	4	013	○
P3(P2+20)	14	14.12	TNMR016Q120	1.5P	200	26	-	60	12.5	10	13	4	013	○	

Intro

SP

SL

PO

ST

ROLL

CARBIDE

LONG

JIS

HAND
TAPS

EG (STI)

SPECIAL
THREADS,
GAUGESTHREAD
MILLS

DIES

CENTER
DRILLSTechnical
info

Long Taps

Intro

	M	TCTR (tolerance)	 Hole Ø (mm)	Code	THCHT (chamfer)	LF (mm)	THL (mm)	LU (mm)	LS (mm)	DCON (mm)	K (mm)	LK (mm)	NOF	Type	Stock		
	JIS																
SP	M18X2.5	P3	15.5	15.63	TNMR018R515	5P	150	33	-	70	14	11	14	4	013	○	
		P3	15.5	15.63	TNMR018R520	5P	200	33	-	70	14	11	14	4	013	○	
P3		15.5	15.63	TNMR018R525	5P	250	33	-	70	14	11	14	4	013	○		
SL		P3	15.5	15.63	TNMR018R115	1.5P	150	33	-	70	14	11	14	4	013	○	
		P3	15.5	15.63	TNMR018R120	1.5P	200	33	-	70	14	11	14	4	013	○	
PO		P3	15.5	15.63	TNMR018R125	1.5P	250	33	-	70	14	11	14	4	013	○	
		P4(P3+20)	15.5	15.63	TNMS018R515	5P	150	33	-	70	14	11	14	4	013	○	
ST		P4(P3+20)	15.5	15.63	TNMS018R115	1.5P	150	33	-	70	14	11	14	4	013	○	
		P4(P3+20)	15.5	15.63	TNMS018R520	5P	200	33	-	70	14	11	14	4	013	○	
ROLL		M20X2.5	P3	17.5	17.63	TNMR020R515	5P	150	33	-	70	15	12	15	4	013	○
	P3		17.5	17.63	TNMR020R520	5P	200	33	-	70	15	12	15	4	013	○	
P3	17.5		17.63	TNMR020R525	5P	250	33	-	70	15	12	15	4	013	○		
CARBIDE	P3		17.5	17.63	TNMR020R115	1.5P	150	33	-	70	15	12	15	4	013	○	
	P3		17.5	17.63	TNMR020R120	1.5P	200	33	-	70	15	12	15	4	013	○	
LONG JIS	P3		17.5	17.63	TNMR020R125	1.5P	250	33	-	70	15	12	15	4	013	○	
	P4(P3+20)		17.5	17.63	TNMS020R515	5P	150	33	-	70	15	12	15	4	013	○	
HAND TAPS	P4(P3+20)		17.5	17.63	TNMS020R115	1.5P	150	33	-	70	15	12	15	4	013	○	
	P4(P3+20)		17.5	17.63	TNMS020R520	5P	200	33	-	70	15	12	15	4	013	○	
EG (STI)	M22X2.5		P4(P3+20)	17.5	17.63	TNMS020R120	1.5P	200	33	-	70	15	12	15	4	013	○
		P3	19.5	19.63	TNMR022R515	5P	150	33	-	70	17	13	16	4	013	○	
P3		19.5	19.63	TNMR022R520	5P	200	33	-	70	17	13	16	4	013	○		
P3		19.5	19.63	TNMR022R525	5P	250	33	-	70	17	13	16	4	013	○		
SPECIAL THREADS, GAUGES		P3	19.5	19.63	TNMR022R115	1.5P	150	33	-	70	17	13	16	4	013	○	
		P3	19.5	19.63	TNMR022R120	1.5P	200	33	-	70	17	13	16	4	013	○	
THREAD MILLS		P3	19.5	19.63	TNMR022R125	1.5P	250	33	-	70	17	13	16	4	013	○	
		P4(P3+20)	19.5	19.63	TNMS022R515	5P	150	33	-	70	17	13	16	4	013	○	
DIES		M24X3	P4(P3+20)	19.5	19.63	TNMS022R115	1.5P	150	33	-	70	17	13	16	4	013	○
			P4(P3+20)	19.5	19.63	TNMS022R520	5P	200	33	-	70	17	13	16	4	013	○
P3	21		21.13	TNMR024S515	5P	150	39	-	80	19	15	18	4	013	○		
P3	21		21.13	TNMR024S520	5P	200	39	-	80	19	15	18	4	013	○		
CENTER DRILLS	P3		21	21.13	TNMR024S525	5P	250	39	-	80	19	15	18	4	013	○	
	P3		21	21.13	TNMR024S115	1.5P	150	39	-	80	19	15	18	4	013	○	
TECHNICAL INFO	P3		21	21.13	TNMR024S120	1.5P	200	39	-	80	19	15	18	4	013	○	
	P3		21	21.13	TNMR024S125	1.5P	250	39	-	80	19	15	18	4	013	○	
DIES	M27X3		P4(P3+20)	21	21.13	TNMS024S515	5P	150	39	-	80	19	15	18	4	013	○
			P4(P3+20)	21	21.13	TNMS024S115	1.5P	150	39	-	80	19	15	18	4	013	○
P4(P3+20)		21	21.13	TNMS024S520	5P	200	39	-	80	19	15	18	4	013	○		
P4(P3+20)		21	21.13	TNMS024S120	1.5P	200	39	-	80	19	15	18	4	013	○		
DIES		M27X3	P3	24	24.13	TNMR027S520	5P	200	39	-	80	20	15	18	4	013	○
			P3	24	24.13	TNMR027S525	5P	250	39	-	80	20	15	18	4	013	○
P3			24	24.13	TNMR027S120	1.5P	200	39	-	80	20	15	18	4	013	○	
P3			24	24.13	TNMR027S125	1.5P	250	39	-	80	20	15	18	4	013	○	

M	TCTR (tolerance)	\varnothing (mm)	Hole \varnothing (mm)	Code	THCHT (chamfer)	LF (mm)	THL (mm)	LU (mm)	LS (mm)	DCON (mm)	K (mm)	LK (mm)	NOF	Type	Stock
JIS															
M30X3.5	P4	26.5	26.63	TNMS030T520	5P	200	46	-	80	23	17	20	4	013	○
	P4	26.5	26.63	TNMS030T525	5P	250	46	-	80	23	17	20	4	013	○
	P4	26.5	26.63	TNMS030T530	5P	300	46	-	80	23	17	20	4	013	○
	P4	26.5	26.63	TNMS030T120	1.5P	200	46	-	80	23	17	20	4	013	○
	P4	26.5	26.63	TNMS030T125	1.5P	250	46	-	80	23	17	20	4	013	○
	P4	26.5	26.63	TNMS030T130	1.5P	300	46	-	80	23	17	20	4	013	○
M33X3.5	P4	29.5	29.63	L25033T5-S	5P	250	51	-	80	25	19	22	4	013	○
	P4	29.5	29.63	L25033T1-S	1.5P	250	51	-	80	25	19	22	4	013	○
M36X4	P4	32	32.12	L25036U5-S	5P	250	57	-	100	28	21	24	4	013	○
	P4	32	32.12	L30036U5-S	5P	300	57	-	100	28	21	24	4	013	○
	P4	32	32.12	L25036U1-S	1.5P	250	57	-	100	28	21	24	4	013	○
	P4	32	32.12	L30036U1-S	1.5P	300	57	-	100	28	21	24	4	013	○
M39X4	P4	35	35.12	L30039U5-S	5P	300	60	-	100	30	23	26	4	013	○
	P4	35	35.12	L30039U1-S	1.5P	300	60	-	100	30	23	26	4	013	○
M42X4.5	P4	37.5	37.63	L25042V5-S	5P	250	60	-	100	32	26	30	4	013	○
	P4	37.5	37.63	L30042V5-S	5P	300	60	-	100	32	26	30	4	013	○
	P4	37.5	37.63	L25042V1-S	1.5P	250	60	-	100	32	26	30	4	013	○
M45X4.5	P4	40.5	40.63	L30045V5-S	5P	300	67	-	100	35	26	30	4	013	○
	P4	40.5	40.63	L30045V1-S	1.5P	300	67	-	100	35	26	30	4	013	○
M48X5	P4	43	43.12	L30048W5-S	5P	300	67	-	100	38	29	32	4	013	○
	P4	43	43.12	L30048W1-S	1.5P	300	67	-	100	38	29	32	4	013	○
JIS															
M8X1	P2	7	7.09	TNMQ8.0M510	5P	100	19	-	50	6.2	5	8	4	013	○
	P2	7	7.09	TNMQ8.0M512	5P	120	19	-	50	6.2	5	8	4	013	○
	P2	7	7.09	TNMQ8.0M515	5P	150	19	-	50	6.2	5	8	4	013	○
	P2	7	7.09	TNMQ8.0M110	1.5P	100	19	-	50	6.2	5	8	4	013	○
	P2	7	7.09	TNMQ8.0M112	1.5P	120	19	-	50	6.2	5	8	4	013	○
	P2	7	7.09	TNMQ8.0M115	1.5P	150	19	-	50	6.2	5	8	4	013	○
M10X1.25	P2	8.8	8.85	TNMQ010N510	5P	100	23	-	50	7	5.5	8	4	013	○
	P2	8.8	8.85	TNMQ010N512	5P	120	23	-	50	7	5.5	8	4	013	○
	P2	8.8	8.85	TNMQ010N515	5P	150	23	-	50	7	5.5	8	4	013	○
	P2	8.8	8.85	TNMQ010N520	5P	200	23	-	50	7	5.5	8	4	013	○
	P2	8.8	8.85	TNMQ010N110	1.5P	100	23	-	50	7	5.5	8	4	013	○
	P2	8.8	8.85	TNMQ010N112	1.5P	120	23	-	50	7	5.5	8	4	013	○
	P2	8.8	8.85	TNMQ010N115	1.5P	150	23	-	50	7	5.5	8	4	013	○
	P2	8.8	8.85	TNMQ010N120	1.5P	200	23	-	50	7	5.5	8	4	013	○
	P3(P2+20)	8.8	8.85	TNMR010N510	5P	100	23	-	50	7	5.5	8	4	013	○
	P3(P2+20)	8.8	8.85	TNMR010N110	1.5P	100	23	-	50	7	5.5	8	4	013	○
	P4(P2+40)	8.8	8.85	TNMS010N510	5P	100	23	-	50	7	5.5	8	4	013	○
	P4(P2+40)	8.8	8.85	TNMS010N515	5P	150	23	-	50	7	5.5	8	4	013	○
	P4(P2+40)	8.8	8.85	TNMS010N110	1.5P	100	23	-	50	7	5.5	8	4	013	○
P4(P2+40)	8.8	8.85	TNMS010N115	1.5P	150	23	-	50	7	5.5	8	4	013	○	
P3(P2+20)	8.8	8.85	TNMR010N515	5P	150	23	-	50	7	5.5	8	4	013	○	
P3(P2+20)	8.8	8.85	TNMR010N115	1.5P	150	23	-	50	7	5.5	8	4	013	○	

Intro

SP

SL

PO

ST

ROLL

CARBIDE

LONG

JIS

HAND
TAPS

EG (STI)

SPECIAL
THREADS,
GAUGESTHREAD
MILLS

DIES

CENTER
DRILLSTechnical
info

Long Taps

Intro	MF	TCTR (tolerance)	\varnothing (mm)	Hole \varnothing (mm)	Code	THCHT (chamfer)	LF (mm)	THL (mm)	LU (mm)	LS (mm)	DCON (mm)	K (mm)	LK (mm)	NOF	Type	Stock
	JIS															
SP	M10X1	P2	9	9.09	TNMQ010M510	5P	100	23	-	50	7	5.5	8	4	013	○
		P2	9	9.09	TNMQ010M512	5P	120	23	-	50	7	5.5	8	4	013	○
		P2	9	9.09	TNMQ010M515	5P	150	23	-	50	7	5.5	8	4	013	○
		P2	9	9.09	TNMQ010M110	1.5P	100	23	-	50	7	5.5	8	4	013	○
		P2	9	9.09	TNMQ010M112	1.5P	120	23	-	50	7	5.5	8	4	013	○
SL		P2	9	9.09	TNMQ010M115	1.5P	150	23	-	50	7	5.5	8	4	013	○
PO	M12X1.5	P2	10.5	10.6	TNMQ0120510	5P	100	26	-	50	8.5	6.5	9	4	013	○
		P2	10.5	10.6	TNMQ0120512	5P	120	26	-	50	8.5	6.5	9	4	013	○
		P2	10.5	10.6	TNMQ0120515	5P	150	26	-	50	8.5	6.5	9	4	013	○
		P2	10.5	10.6	TNMQ0120520	5P	200	26	-	50	8.5	6.5	9	4	013	○
		P2	10.5	10.6	TNMQ0120110	1.5P	100	26	-	50	8.5	6.5	9	4	013	○
ST		P2	10.5	10.6	TNMQ0120112	1.5P	120	26	-	50	8.5	6.5	9	4	013	○
ROLL	M12X1.5	P2	10.5	10.6	TNMQ0120115	1.5P	150	26	-	50	8.5	6.5	9	4	013	○
		P2	10.5	10.6	TNMQ0120120	1.5P	200	26	-	50	8.5	6.5	9	4	013	○
		P4(P2+40)	10.5	10.6	TNMS0120515	5P	150	26	-	50	8.5	6.5	9	4	013	○
		P4(P2+40)	10.5	10.6	TNMS0120520	5P	200	26	-	50	8.5	6.5	9	4	013	○
		P4(P2+40)	10.5	10.6	TNMS0120115	1.5P	150	26	-	50	8.5	6.5	9	4	013	○
CARBIDE	M12X1.5	P4(P2+40)	10.5	10.6	TNMS0120120	1.5P	200	26	-	50	8.5	6.5	9	4	013	○
		P3(P2+20)	10.5	10.6	TNMR0120515	5P	150	26	-	50	8.5	6.5	9	4	013	○
		P3(P2+20)	10.5	10.6	TNMR0120115	1.5P	150	26	-	50	8.5	6.5	9	4	013	○
		P2	10.8	10.85	TNMQ012N510	5P	100	26	-	50	8.5	6.5	9	4	013	○
		P2	10.8	10.85	TNMQ012N512	5P	120	26	-	50	8.5	6.5	9	4	013	○
LONG JIS	M12X1.25	P2	10.8	10.85	TNMQ012N515	5P	150	26	-	50	8.5	6.5	9	4	013	○
		P2	10.8	10.85	TNMQ012N520	5P	200	26	-	50	8.5	6.5	9	4	013	○
		P2	10.8	10.85	TNMQ012N110	1.5P	100	26	-	50	8.5	6.5	9	4	013	○
		P2	10.8	10.85	TNMQ012N112	1.5P	120	26	-	50	8.5	6.5	9	4	013	○
		P2	10.8	10.85	TNMQ012N115	1.5P	150	26	-	50	8.5	6.5	9	4	013	○
HAND TAPS	M12X1.25	P2	10.8	10.85	TNMQ012N120	1.5P	200	26	-	50	8.5	6.5	9	4	013	○
		P4(P2+40)	10.8	10.85	TNMS012N515	5P	150	26	-	50	8.5	6.5	9	4	013	○
		P4(P2+40)	10.8	10.85	TNMS012N520	5P	200	26	-	50	8.5	6.5	9	4	013	○
		P4(P2+40)	10.8	10.85	TNMS012N115	1.5P	150	26	-	50	8.5	6.5	9	4	013	○
		P4(P2+40)	10.8	10.85	TNMS012N120	1.5P	200	26	-	50	8.5	6.5	9	4	013	○
EG (STI)	M12X1.25	P3(P2+20)	10.8	10.85	TNMR012N515	5P	150	26	-	50	8.5	6.5	9	4	013	○
		P3(P2+20)	10.8	10.85	TNMR012N115	1.5P	150	26	-	50	8.5	6.5	9	4	013	○
		P2	11	11.09	TNMQ012M510	5P	100	26	-	50	8.5	6.5	9	4	013	○
		P2	11	11.09	TNMQ012M515	5P	150	26	-	50	8.5	6.5	9	4	013	○
		P2	11	11.09	TNMQ012M110	1.5P	100	26	-	50	8.5	6.5	9	4	013	○
SPECIAL THREADS, GAUGES	M12X1	P2	11	11.09	TNMQ012M115	1.5P	150	26	-	50	8.5	6.5	9	4	013	○
		P2	11	11.09	TNMQ012M512	5P	120	26	-	50	8.5	6.5	9	4	013	○
		P2	11	11.09	TNMQ012M112	1.5P	120	26	-	50	8.5	6.5	9	4	013	○
		P2	11	11.09	TNMQ012M510	5P	100	26	-	50	8.5	6.5	9	4	013	○
		P2	11	11.09	TNMQ012M515	5P	150	26	-	50	8.5	6.5	9	4	013	○
THREAD MILLS	M12X1	P2	11	11.09	TNMQ012M110	1.5P	100	26	-	50	8.5	6.5	9	4	013	○
		P2	11	11.09	TNMQ012M115	1.5P	150	26	-	50	8.5	6.5	9	4	013	○
		P2	11	11.09	TNMQ012M512	5P	120	26	-	50	8.5	6.5	9	4	013	○
		P2	11	11.09	TNMQ012M510	5P	100	26	-	50	8.5	6.5	9	4	013	○
		P2	11	11.09	TNMQ012M515	5P	150	26	-	50	8.5	6.5	9	4	013	○

DIES

CENTER
DRILLS

Technical
info

MF	TCTR (tolerance)	\varnothing (mm)	Hole \varnothing (mm)	Code	THCHT (chamfer)	LF (mm)	THL (mm)	LU (mm)	LS (mm)	DCON (mm)	K (mm)	LK (mm)	NOF	Type	Stock
JIS															
M14X1.5	P2	12.5	12.6	TNMQ0140512	5P	120	26	-	60	10.5	8	11	4	013	○
	P2	12.5	12.6	TNMQ0140515	5P	150	26	-	60	10.5	8	11	4	013	○
	P2	12.5	12.6	TNMQ0140520	5P	200	26	-	60	10.5	8	11	4	013	○
	P2	12.5	12.6	TNMQ0140112	1.5P	120	26	-	60	10.5	8	11	4	013	○
	P2	12.5	12.6	TNMQ0140115	1.5P	150	26	-	60	10.5	8	11	4	013	○
	P2	12.5	12.6	TNMQ0140120	1.5P	200	26	-	60	10.5	8	11	4	013	○
	P3(P2+20)	12.5	12.6	TNMR0140515	5P	150	26	-	60	10.5	8	11	4	013	○
P3(P2+20)	12.5	12.6	TNMR0140115	1.5P	150	26	-	60	10.5	8	11	4	013	○	
M14X1	P2	13	13.09	TNMQ014M515	5P	150	26	-	60	10.5	8	11	4	013	○
	P2	13	13.09	TNMQ014M115	1.5P	150	26	-	60	10.5	8	11	4	013	○
M16X1.5	P2	14.5	14.6	TNMQ0160515	5P	150	26	-	60	12.5	10	13	4	013	○
	P2	14.5	14.6	TNMQ0160520	5P	200	26	-	60	12.5	10	13	4	013	○
	P2	14.5	14.6	TNMQ0160115	1.5P	150	26	-	60	12.5	10	13	4	013	○
	P2	14.5	14.6	TNMQ0160120	1.5P	200	26	-	60	12.5	10	13	4	013	○
	P2	14.5	14.6	TNMQ0160512	5P	120	26	-	60	12.5	10	13	4	013	○
	P2	14.5	14.6	TNMQ0160112	1.5P	120	26	-	60	12.5	10	13	4	013	○
	P3(P2+20)	14.5	14.6	TNMR0160515	5P	150	26	-	60	12.5	10	13	4	013	○
P3(P2+20)	14.5	14.6	TNMR0160115	1.5P	150	26	-	60	12.5	10	13	4	013	○	
M16X1	P2	15	15.09	TNMQ016M515	5P	150	26	-	60	12.5	10	13	4	013	○
	P2	15	15.09	TNMQ016M115	1.5P	150	26	-	60	12.5	10	13	4	013	○
M18X2	P3	16	16.12	TNMR018Q520	5P	200	33	-	70	14	11	14	4	013	○
	P3	16	16.12	TNMR018Q120	1.5P	200	33	-	70	14	11	14	4	013	○
M18X1.5	P2	16.5	16.6	TNMQ0180515	5P	150	33	-	70	14	11	14	4	013	○
	P2	16.5	16.6	TNMQ0180520	5P	200	33	-	70	14	11	14	4	013	○
	P2	16.5	16.6	TNMQ0180115	1.5P	150	33	-	70	14	11	14	4	013	○
	P2	16.5	16.6	TNMQ0180120	1.5P	200	33	-	70	14	11	14	4	013	○
	P3(P2+20)	16.5	16.6	TNMR0180515	5P	150	33	-	70	14	11	14	4	013	○
P3(P2+20)	16.5	16.6	TNMR0180115	1.5P	150	33	-	70	14	11	14	4	013	○	
M20X2	P3	18	18.12	TNMR020Q520	5P	200	33	-	70	15	12	15	4	013	○
	P3	18	18.12	TNMR020Q120	1.5P	200	33	-	70	15	12	15	4	013	○
M20X1.5	P3	18.5	18.6	TNMR0200515	5P	150	33	-	70	15	12	15	4	013	○
	P3	18.5	18.6	TNMR0200520	5P	200	33	-	70	15	12	15	4	013	○
	P3	18.5	18.6	TNMR0200115	1.5P	150	33	-	70	15	12	15	4	013	○
	P3	18.5	18.6	TNMR0200120	1.5P	200	33	-	70	15	12	15	4	013	○
	P4(P3+20)	18.5	18.6	TNMS0200515	5P	150	33	-	70	15	12	15	4	013	○
P4(P3+20)	18.5	18.6	TNMS0200115	1.5P	150	33	-	70	15	12	15	4	013	○	
M22X2	P3	20	20.12	TNMR022Q520	5P	200	33	-	70	17	13	16	4	013	○
	P3	20	20.12	TNMR022Q120	1.5P	200	33	-	70	17	13	16	4	013	○
M22X1.5	P3	20.5	20.6	TNMR0220515	5P	150	33	-	70	17	13	16	4	013	○
	P3	20.5	20.6	TNMR0220520	5P	200	33	-	70	17	13	16	4	013	○
	P3	20.5	20.6	TNMR0220115	1.5P	150	33	-	70	17	13	16	4	013	○
	P3	20.5	20.6	TNMR0220120	1.5P	200	33	-	70	17	13	16	4	013	○
M24X2	P3	22	22.12	TNMR024Q520	5P	200	39	-	80	19	15	18	4	013	○
	P3	22	22.12	TNMR024Q120	1.5P	200	39	-	80	19	15	18	4	013	○

Intro

SP

SL

PO

ST

ROLL

CARBIDE

LONG

JIS

HAND
TAPS

EG (STI)

SPECIAL
THREADS,
GAUGESTHREAD
MILLS

DIES

CENTER
DRILLSTechnical
info

Long Taps

Intro

SP

SL

PO

ST

ROLL

CARBIDE

LONG

JIS

HAND
TAPS

EG (STI)

SPECIAL
THREADS,
GAUGES

THREAD
MILLS

DIES

CENTER
DRILLS

Technical
info



MF	TCTR (tolerance)	\varnothing (mm)	Hole \varnothing (mm)	Code	THCHT (chamfer)	LF (mm)	THL (mm)	LU (mm)	LS (mm)	DCON (mm)	K (mm)	LK (mm)	NOF	Type	Stock
JIS															
M24X1.5	P3	22.5	22.6	TNMR0240515	5P	150	39	-	80	19	15	18	4	013	○
	P3	22.5	22.6	TNMR0240520	5P	200	39	-	80	19	15	18	4	013	○
	P3	22.5	22.6	TNMR0240115	1.5P	150	39	-	80	19	15	18	4	013	○
	P3	22.5	22.6	TNMR0240120	1.5P	200	39	-	80	19	15	18	4	013	○
M27X2	P3	25	25.12	TNMR027Q525	5P	250	39	-	80	20	15	18	4	013	○
	P3	25	25.12	TNMR027Q125	1.5P	250	39	-	80	20	15	18	4	013	○
	P3	25	25.12	TNMR027Q520	5P	200	39	-	80	20	15	18	4	013	○
	P3	25	25.12	TNMR027Q120	1.5P	200	39	-	80	20	15	18	4	013	○
M27X1.5	P3	25.5	25.6	TNMR027Q520	5P	200	39	-	80	20	15	18	4	013	○
	P3	25.5	25.6	TNMR027Q525	5P	250	39	-	80	20	15	18	4	013	○
	P3	25.5	25.6	TNMR027Q120	1.5P	200	39	-	80	20	15	18	4	013	○
	P3	25.5	25.6	TNMR027Q125	1.5P	250	39	-	80	20	15	18	4	013	○
M30X3	P3	27	27.13	TNMR030S525	5P	250	46	-	80	23	17	20	4	013	○
	P3	27	27.13	TNMR030S125	1.5P	250	46	-	80	23	17	20	4	013	○
	P3	27	27.13	TNMR030S520	5P	200	46	-	80	23	17	20	4	013	○
	P3	27	27.13	TNMR030S120	1.5P	200	46	-	80	23	17	20	4	013	○
M30X2	P3	28	28.12	TNMR030Q520	5P	200	46	-	80	23	17	20	4	013	○
	P3	28	28.12	TNMR030Q525	5P	250	46	-	80	23	17	20	4	013	○
	P3	28	28.12	TNMR030Q120	1.5P	200	46	-	80	23	17	20	4	013	○
	P3	28	28.12	TNMR030Q125	1.5P	250	46	-	80	23	17	20	4	013	○
M30X1.5	P3	28.5	28.6	TNMR030Q520	5P	200	46	-	80	23	17	20	4	013	○
	P3	28.5	28.6	TNMR030Q525	5P	250	46	-	80	23	17	20	4	013	○
	P3	28.5	28.6	TNMR030Q120	1.5P	200	46	-	80	23	17	20	4	013	○
	P3	28.5	28.6	TNMR030Q125	1.5P	250	46	-	80	23	17	20	4	013	○
M33X3	P3	30	30.13	L25033S5-R	5P	250	51	-	80	25	19	22	4	013	○
	P3	30	30.13	L25033S1-R	1.5P	250	51	-	80	25	19	22	4	013	○
M33X2	P3	31	31.12	L25033Q5-R	5P	250	45	-	80	25	19	22	4	013	○
	P3	31	31.12	L25033Q1-R	1.5P	250	45	-	80	25	19	22	4	013	○
M33X1.5	P3	31.5	31.6	L25033Q5-R	5P	250	45	-	80	25	19	22	4	013	○
	P3	31.5	31.6	L25033Q1-R	1.5P	250	45	-	80	25	19	22	4	013	○
M36X3	P3	33	33.13	L25036S5-R	5P	250	57	-	100	28	21	24	4	013	○
	P3	33	33.13	L25036S1-R	1.5P	250	57	-	100	28	21	24	4	013	○
M36X2	P3	34	34.12	L25036Q5-R	5P	250	45	-	100	28	21	24	4	013	○
	P3	34	34.12	L25036Q1-R	1.5P	250	45	-	100	28	21	24	4	013	○
M36X1.5	P3	34.5	34.6	L25036Q5-R	5P	250	45	-	100	28	21	24	4	013	○
	P3	34.5	34.6	L25036Q1-R	1.5P	250	45	-	100	28	21	24	4	013	○
M39X3	P3	36	36.13	L25039S5-R	5P	250	60	-	100	30	23	26	4	013	○
	P3	36	36.13	L25039S1-R	1.5P	250	60	-	100	30	23	26	4	013	○
M39X2	P3	37	37.12	L25039Q5-R	5P	250	45	-	100	30	23	26	4	013	○
	P3	37	37.12	L25039Q1-R	1.5P	250	45	-	100	30	23	26	4	013	○
M39X1.5	P3	37.5	37.6	L25039Q5-R	5P	250	45	-	100	30	23	26	4	013	○
	P3	37.5	37.6	L25039Q1-R	1.5P	250	45	-	100	30	23	26	4	013	○
M40X3	P3	37	37.13	L25040S5-R	5P	250	60	-	100	30	23	26	4	013	○
	P3	37	37.13	L30040S5-R	5P	300	60	-	100	30	23	26	4	013	○
	P3	37	37.13	L25040S1-R	1.5P	250	60	-	100	30	23	26	4	013	○

MF	TCTR (tolerance)	\varnothing (mm)	Hole \varnothing (mm)	Code	THCHT (chamfer)	LF (mm)	THL (mm)	LU (mm)	LS (mm)	DCON (mm)	K (mm)	LK (mm)	NOF	Type	Stock
JIS															
M40X2	P3	38	38.12	L25040Q5-R	5P	250	45	-	100	30	23	26	4	013	○
	P3	38	38.12	L30040Q5-R	5P	300	45	-	100	30	23	26	4	013	○
	P3	38	38.12	L25040Q1-R	1.5P	250	45	-	100	30	23	26	4	013	○
	P3	38	38.12	L30040Q1-R	1.5P	300	45	-	100	30	23	26	4	013	○
M40X1.5	P3	38.5	38.6	L2504005-R	5P	250	45	-	100	30	23	26	4	013	○
	P3	38.5	38.6	L3004005-R	5P	300	45	-	100	30	23	26	4	013	○
	P3	38.5	38.6	L2504001-R	1.5P	250	45	-	100	30	23	26	4	013	○
	P3	38.5	38.6	L3004001-R	1.5P	300	45	-	100	30	23	26	4	013	○
M42X3	P3	39	39.13	L25042S5-R	5P	250	60	-	100	32	26	30	4	013	○
	P3	39	39.13	L30042S5-R	5P	300	60	-	100	32	26	30	4	013	○
	P3	39	39.13	L25042S1-R	1.5P	250	60	-	100	32	26	30	4	013	○
	P3	39	39.13	L30042S1-R	1.5P	300	60	-	100	32	26	30	4	013	○
M42X2	P3	40	40.12	L25042Q5-R	5P	250	45	-	100	32	26	30	4	013	○
	P3	40	40.12	L30042Q5-R	5P	300	45	-	100	32	26	30	4	013	○
	P3	40	40.12	L25042Q1-R	1.5P	250	45	-	100	32	26	30	4	013	○
	P3	40	40.12	L30042Q1-R	1.5P	300	45	-	100	32	26	30	4	013	○
M42X1.5	P3	40.5	40.6	L3004205-R	5P	300	45	-	100	32	26	30	4	013	○
	P3	40.5	40.6	L2504201-R	1.5P	250	45	-	100	32	26	30	4	013	○
	P3	40.5	40.6	L3004201-R	1.5P	300	45	-	100	32	26	30	4	013	○
	P3	40.5	40.6	L2504205-R	5P	250	45	-	100	32	26	30	4	013	○
M45X3	P3	42	42.13	L30045S5-R	5P	300	67	-	100	35	26	30	4	013	○
	P3	42	42.13	L30045S1-R	1.5P	300	67	-	100	35	26	30	4	013	○
M45X2	P3	43	43.12	L30045Q5-R	5P	300	45	-	100	35	26	30	4	013	○
	P3	43	43.12	L30045Q1-R	1.5P	300	45	-	100	35	26	30	4	013	○
M45X1.5	P3	43.5	43.6	L3004505-R	5P	300	45	-	100	35	26	30	4	013	○
	P3	43.5	43.6	L3004501-R	1.5P	300	45	-	100	35	26	30	4	013	○
M48X3	P3	45	45.13	L30048S5-R	5P	300	67	-	100	38	29	32	4	013	○
	P3	45	45.13	L30048S1-R	1.5P	300	67	-	100	38	29	32	4	013	○
M48X2	P3	46	46.12	L30048Q5-R	5P	300	45	-	100	38	29	32	4	013	○
	P3	46	46.12	L30048Q1-R	1.5P	300	45	-	100	38	29	32	4	013	○
M48X1.5	P3	46.5	46.6	L3004805-R	5P	300	45	-	100	38	29	32	4	013	○
	P3	46.5	46.6	L3004801-R	1.5P	300	45	-	100	38	29	32	4	013	○
JIS															
UNC	TCTR (tolerance)	\varnothing (mm)	Hole \varnothing (mm)	Code	THCHT (chamfer)	LF (mm)	THL (mm)	LU (mm)	LS (mm)	DCON (mm)	K (mm)	LK (mm)	NOF	Type	Stock
JIS															
1/4-20UNC	P2	5.1	5.19	TNFQU04N515	5P	150	15	30	40	6	4.5	7	3	011	○
	P2	5.1	5.19	TNFQU04N520	5P	200	15	30	40	6	4.5	7	3	011	○
	P2	5.1	5.19	TNFQU04N115	1.5P	150	15	30	40	6	4.5	7	3	011	○
	P2	5.1	5.19	TNFQU04N120	1.5P	200	15	30	40	6	4.5	7	3	011	○
5/16-18UNC	P2	6.6	6.65	TNMQU050515	5P	150	19	-	50	6.2	5	8	4	013	○
	P2	6.6	6.65	TNMQU050520	5P	200	19	-	50	6.2	5	8	4	013	○
	P2	6.6	6.65	TNMQU0505115	1.5P	150	19	-	50	6.2	5	8	4	013	○
	P2	6.6	6.65	TNMQU0505120	1.5P	200	19	-	50	6.2	5	8	4	013	○
3/8-16UNC	P2	8	8.07	TNMQU06P515	5P	150	23	-	50	7	5.5	8	4	013	○
	P2	8	8.07	TNMQU06P520	5P	200	23	-	50	7	5.5	8	4	013	○
	P2	8	8.07	TNMQU06P115	1.5P	150	23	-	50	7	5.5	8	4	013	○
	P2	8	8.07	TNMQU06P120	1.5P	200	23	-	50	7	5.5	8	4	013	○

Intro
SP
SL
PO
ST
ROLL
CARBIDE
LONG
JIS
HAND TAPS
EG (STI)
SPECIAL THREADS, GAUGES
THREAD MILLS
DIES
CENTER DRILLS
Technical info

Long Taps

Intro

	UNC	TCTR (tolerance)	 Hole Ø (mm)	Hole Ø (mm)	Code	THCHT (chamfer)	LF (mm)	THL (mm)	LU (mm)	LS (mm)	DCON (mm)	K (mm)	LK (mm)	NOF	Type	Stock	
	JIS																
SP	7/16-14UNC	P3	9.4	9.45	TNMRU07Q515	5P	150	26	-	50	8.5	6.5	9	4	013	○	
		P3	9.4	9.45	TNMRU07Q115	1.5P	150	26	-	50	8.5	6.5	9	4	013	○	
		P3	9.4	9.45	TNMRU07Q520	5P	200	26	-	50	8.5	6.5	9	4	013	○	
SL	1/2-13UNC	P3	10.9	10.91	TNMRU08R515	5P	150	26	-	60	10.5	8	11	4	013	○	
		P3	10.9	10.91	TNMRU08R520	5P	200	26	-	60	10.5	8	11	4	013	○	
		P3	10.9	10.91	TNMRU08R115	1.5P	150	26	-	60	10.5	8	11	4	013	○	
PO	5/8-11UNC	P3	13.6	13.75	TNMRU10U515	5P	150	26	-	60	12.5	10	13	4	013	○	
		P3	13.6	13.75	TNMRU10U520	5P	200	26	-	60	12.5	10	13	4	013	○	
		P3	13.6	13.75	TNMRU10U115	1.5P	150	26	-	60	12.5	10	13	4	013	○	
ST	3/4-10UNC	P3	16.6	16.7	TNMRU12V515	5P	150	33	-	70	15	12	15	4	013	○	
		P3	16.6	16.7	TNMRU12V520	5P	200	33	-	70	15	12	15	4	013	○	
		P3	16.6	16.7	TNMRU12V115	1.5P	150	33	-	70	15	12	15	4	013	○	
ROLL	7/8-9UNC	P3	19.6	19.61	TNMRU14W520	5P	200	33	-	70	17	13	16	4	013	○	
		P3	19.6	19.61	TNMRU14W120	1.5P	200	33	-	70	17	13	16	4	013	○	
		P3	19.6	19.61	TNMRU14W515	5P	150	39	-	80	19	15	18	4	013	○	
CARBIDE	1-8UNC	P3	22.3	22.45	TNMRU16X515	5P	150	39	-	80	19	15	18	4	013	○	
		P3	22.3	22.45	TNMRU16X520	5P	200	39	-	80	19	15	18	4	013	○	
		P3	22.3	22.45	TNMRU16X115	1.5P	150	39	-	80	19	15	18	4	013	○	
LONG JIS	UNF	TCTR (tolerance)	 (mm)	Hole Ø (mm)	Code	THCHT (chamfer)	LF (mm)	THL (mm)	LU (mm)	LS (mm)	DCON (mm)	K (mm)	LK (mm)	NOF	Type	Stock	
		JIS															
		P2	5.5	5.53	TNFQU04K515	5P	150	15	30	40	6	4.5	7	3	011	○	
HAND TAPS	1/4-28UNF	P2	5.5	5.53	TNFQU04K520	5P	200	15	30	40	6	4.5	7	3	011	○	
		P2	5.5	5.53	TNFQU04K115	1.5P	150	15	30	40	6	4.5	7	3	011	○	
		P2	5.5	5.53	TNFQU04K120	1.5P	200	15	30	40	6	4.5	7	3	011	○	
EG (STI)	5/16-24UNF	P2	6.9	6.97	TNMQU05M515	5P	150	19	-	50	6.2	5	8	4	013	○	
		P2	6.9	6.97	TNMQU05M520	5P	200	19	-	50	6.2	5	8	4	013	○	
		P2	6.9	6.97	TNMQU05M115	1.5P	150	19	-	50	6.2	5	8	4	013	○	
SPECIAL THREADS, GAUGES	3/8-24UNF	P2	6.9	6.97	TNMQU05M120	1.5P	200	19	-	50	6.2	5	8	4	013	○	
		P2	8.5	8.57	TNMQU06M515	5P	150	23	-	50	7	5.5	8	4	013	○	
		P2	8.5	8.57	TNMQU06M520	5P	200	23	-	50	7	5.5	8	4	013	○	
THREAD MILLS	7/16-20UNF	P2	8.5	8.57	TNMQU06M115	1.5P	150	23	-	50	7	5.5	8	4	013	○	
		P2	8.5	8.57	TNMQU06M120	1.5P	200	23	-	50	7	5.5	8	4	013	○	
		P2	9.9	9.96	TNMQU07N515	5P	150	26	-	50	8.5	6.5	9	4	013	○	
DIES	1/2-20UNF	P2	9.9	9.96	TNMQU07N520	5P	200	26	-	50	8.5	6.5	9	4	013	○	
		P2	9.9	9.96	TNMQU07N115	1.5P	150	26	-	50	8.5	6.5	9	4	013	○	
		P2	9.9	9.96	TNMQU07N120	1.5P	200	26	-	50	8.5	6.5	9	4	013	○	
CENTER DRILLS	1/2-20UNF	P2	11.5	11.54	TNMQU08N515	5P	150	26	-	60	10.5	8	11	4	013	○	
		P2	11.5	11.54	TNMQU08N520	5P	200	26	-	60	10.5	8	11	4	013	○	
		P2	11.5	11.54	TNMQU08N115	1.5P	150	26	-	60	10.5	8	11	4	013	○	
P2	11.5	11.54	TNMQU08N120	1.5P	200	26	-	60	10.5	8	11	4	013	○			

Technical
info

UNF	TCTR (tolerance)	\varnothing (mm)	Hole \varnothing (mm)	Code	THCHT (chamfer)	LF (mm)	THL (mm)	LU (mm)	LS (mm)	DCON (mm)	K (mm)	LK (mm)	NOF	Type	Stock
JIS															
9/16-18UNF	P2	12.9	13	TNMQU090515	5P	150	26	-	60	12.5	10	13	4	013	○
	P2	12.9	13	TNMQU090115	1.5P	150	26	-	60	12.5	10	13	4	013	○
5/8-18UNF	P2	14.5	14.6	TNMQU100515	5P	150	26	-	60	12.5	10	13	4	013	○
	P2	14.5	14.6	TNMQU100115	1.5P	150	26	-	60	12.5	10	13	4	013	○
3/4-16UNF	P3	17.5	17.59	TNMRU12P515	5P	150	33	-	70	15	12	15	4	013	○
	P3	17.5	17.59	TNMRU12P115	1.5P	150	33	-	70	15	12	15	4	013	○
	P3	17.5	17.59	TNMRU12P520	5P	200	33	-	70	15	12	15	4	013	○
	P3	17.5	17.59	TNMRU12P120	1.5P	200	33	-	70	15	12	15	4	013	○
7/8-14UNF	P3	20.5	20.57	TNMRU14Q115	1.5P	150	33	-	70	17	13	16	4	013	○
	P3	20.5	20.57	TNMRU14Q120	1.5P	200	33	-	70	17	13	16	4	013	○
1-12UNF	P3	23.3	23.46	TNMRU16S515	5P	150	39	-	80	19	15	18	4	013	○
	P3	23.3	23.46	TNMRU16S115	1.5P	150	39	-	80	19	15	18	4	013	○
BSW															
JIS															
1/4W20	P2	5.1	5.13	TNFQW04N515	5P	150	15	30	40	6	4.5	7	3	011	○
	P2	5.1	5.13	TNFQW04N115	1.5P	150	15	30	40	6	4.5	7	3	011	○
5/16W18	P2	6.5	6.59	TNMQW050515	5P	150	19	-	50	6.2	5	8	4	013	○
	P2	6.5	6.59	TNMQW050520	5P	200	19	-	50	6.2	5	8	4	013	○
	P2	6.5	6.59	TNMQW050115	1.5P	150	19	-	50	6.2	5	8	4	013	○
	P2	6.5	6.59	TNMQW050120	1.5P	200	19	-	50	6.2	5	8	4	013	○
3/8W16	P2	8	8.02	TNMQW06P515	5P	150	23	-	50	7	5.5	8	4	013	○
	P2	8	8.02	TNMQW06P520	5P	200	23	-	50	7	5.5	8	4	013	○
	P2	8	8.02	TNMQW06P115	1.5P	150	23	-	50	7	5.5	8	4	013	○
	P2	8	8.02	TNMQW06P120	1.5P	200	23	-	50	7	5.5	8	4	013	○
7/16W14	P3	9.3	9.39	TNMRW07Q515	5P	150	26	-	50	8.5	6.5	9	4	013	○
	P3	9.3	9.39	TNMRW07Q115	1.5P	150	26	-	50	8.5	6.5	9	4	013	○
1/2W12	P3	10.6	10.7	TNMRW08S515	5P	150	26	-	60	10.5	8	11	4	013	○
	P3	10.6	10.7	TNMRW08S520	5P	200	26	-	60	10.5	8	11	4	013	○
	P3	10.6	10.7	TNMRW08S115	1.5P	150	26	-	60	10.5	8	11	4	013	○
	P3	10.6	10.7	TNMRW08S120	1.5P	200	26	-	60	10.5	8	11	4	013	○
5/8W11	P3	13.5	13.68	TNMRW10U515	5P	150	26	-	60	12.5	10	13	4	013	○
	P3	13.5	13.68	TNMRW10U520	5P	200	26	-	60	12.5	10	13	4	013	○
	P3	13.5	13.68	TNMRW10U115	1.5P	150	26	-	60	12.5	10	13	4	013	○
	P3	13.5	13.68	TNMRW10U120	1.5P	200	26	-	60	12.5	10	13	4	013	○
3/4W10	P3	16.5	16.63	TNMRW12V515	5P	150	33	-	70	15	12	15	4	013	○
	P3	16.5	16.63	TNMRW12V520	5P	200	33	-	70	15	12	15	4	013	○
	P3	16.5	16.63	TNMRW12V115	1.5P	150	33	-	70	15	12	15	4	013	○
	P3	16.5	16.63	TNMRW12V120	1.5P	200	33	-	70	15	12	15	4	013	○
7/8W9	P3	19.5	19.53	TNMRW14W520	5P	200	33	-	70	17	13	16	4	013	○
	P3	19.5	19.53	TNMRW14W120	1.5P	200	33	-	70	17	13	16	4	013	○
1 W8	P3	22.2	22.34	TNMRW16X515	5P	150	39	-	80	19	15	18	4	013	○
	P3	22.2	22.34	TNMRW16X520	5P	200	39	-	80	19	15	18	4	013	○
	P3	22.2	22.34	TNMRW16X525	5P	250	39	-	80	19	15	18	4	013	○
	P3	22.2	22.34	TNMRW16X115	1.5P	150	39	-	80	19	15	18	4	013	○
	P3	22.2	22.34	TNMRW16X120	1.5P	200	39	-	80	19	15	18	4	013	○
	P3	22.2	22.34	TNMRW16X125	1.5P	250	39	-	80	19	15	18	4	013	○

Intro
SP
SL
PO
ST
ROLL
CARBIDE
LONG
JIS
HAND TAPS
EG (STI)
SPECIAL THREADS, GAUGES
THREAD MILLS
DIES
CENTER DRILLS
Technical info

Intro

LS-PF

GP General Purpose Series

Long Shank Straight Fluted Taps for Parallel Pipe Threads



SP

SL



FEATURES

Long shank general purpose for extended overhang on blind and through hole application.

For steel application at low cutting speed, also suitable for cast iron and non-ferrous materials.

PO

Recommended Tapping Speeds Depending On Materials

ISO	Vc (m/min)	ISO	Vc (m/min)	ISO	Vc (m/min)
P1	5÷10 ☆	K1	5÷10 ☆	N2	5÷10 ☆
P2	5÷10 ★	K2	5÷10 ☆	N3	5÷10 ☆
P3	5÷10 ☆	K3	5÷10 ☆	N4	5÷10 ☆
P4	5÷10 ☆				

★ 1st choice ☆ suitable

ROLL

CARBIDE

LONG

JIS

HAND TAPS

EG (STI)

SPECIAL THREADS, GAUGES

THREAD MILLS

DIES

CENTER DRILLS

Technical info

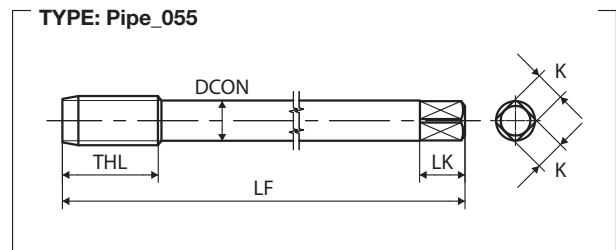
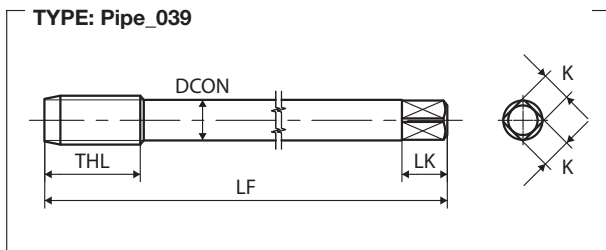

G(BSP)	TCTR (tolerance)	Hole Ø (mm)	Hole Ø (mm)	Code	THCHT (chamfer)	Basic major Ø (mm)	LF (mm)	THL (mm)	LS (mm)	DCON (mm)	K (mm)	LK (mm)	NOF	Type	Stock
JIS															
1/8-28		8.75	8.78	L10F02K	3.5P	9.728	100	19	-	8	6	9	4	039	○
		8.75	8.78	L15F02K	3.5P	9.728	150	19	-	8	6	9	4	039	●
		8.75	8.78	L20F02K	3.5P	9.728	200	19	-	8	6	9	4	039	○
1/4-19		11.75	11.78	L10F04-	3.5P	13.157	100	28	-	11	9	12	4	039	○
		11.75	11.78	L15F04-	3.5P	13.157	150	28	-	11	9	12	4	039	●
		11.75	11.78	L20F04-	3.5P	13.157	200	28	-	11	9	12	4	039	○
3/8-19		15.25	15.28	L10F06-	3.5P	16.662	100	28	-	14	11	14	4	039	○
		15.25	15.28	L15F06-	3.5P	16.662	150	28	-	14	11	14	4	039	○
		15.25	15.28	L20F06-	3.5P	16.662	200	28	-	14	11	14	4	039	○
1/2-14		19	19.04	L15F08Q	3.5P	20.955	150	35	-	18	14	17	4	039	○
		19	19.04	L20F08Q	3.5P	20.955	200	35	-	18	14	17	4	039	○
3/4-14		24.5	24.52	L15F12Q	3.5P	26.441	150	35	-	23	17	20	4	039	○
		24.5	24.52	L20F12Q	3.5P	26.441	200	35	-	23	17	20	4	039	○
1-11		30.75	30.77	L15F16U	3.5P	33.249	150	45	-	26	21	24	4	039	○
		30.75	30.77	L20F16U	3.5P	33.249	200	45	-	26	21	24	4	039	○
1 1/4-11		39.3	39.43	L20F20U	3.5P	41.910	200	45	-	32	26	30	4	055	○
1 1/2-11		45.25	45.33	L20F24U	3.5P	47.803	200	45	-	38	29	32	6	055	○
2-11		57	57.1	L20F32U	3.5P	59.614	200	50	-	46	35	38	6	055	○

LS-PS

GP General Purpose Series

Long Shank Straight Fluted Taps for Parallel Pipe Threads



FEATURES

Long shank general purpose for extended overhang on blind and through hole application.

For steel application at low cutting speed, also suitable for cast iron and non-ferrous materials.

Recommended Tapping Speeds Depending On Materials

ISO	Vc (m/min)	ISO	Vc (m/min)	ISO	Vc (m/min)
P1	5÷10 ☆	K1	5÷10 ☆	N2	5÷10 ☆
P2	5÷10 ★	K2	5÷10 ☆	N3	5÷10 ☆
P3	5÷10 ☆			N4	5÷10 ☆
P4	5÷10 ☆				

★ 1st choice ☆ suitable

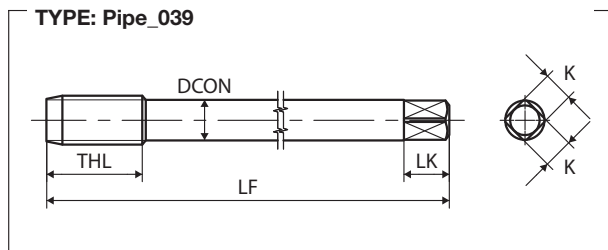

Rp(BSPP)	TCTR (tolerance)	Hole Ø (mm)	Hole Ø (mm)	Code	THCHT (chamfer)	Basic major Ø (mm)	LF (mm)	THL (mm)	LS (mm)	DCON (mm)	K (mm)	LK (mm)	NOF	Type	Stock
JIS															
1/8-28		8.5	8.55	L10P02K	3.5P	9.728	100	19	-	8	6	9	4	039	○
		8.5	8.55	L15P02K	3.5P	9.728	150	19	-	8	6	9	4	039	○
		8.5	8.55	L20P02K	3.5P	9.728	200	19	-	8	6	9	4	039	○
1/4-19		11.4	11.5	L10P04-	3.5P	13.157	100	28	-	11	9	12	4	039	○
		11.4	11.5	L15P04-	3.5P	13.157	150	28	-	11	9	12	4	039	○
		11.4	11.5	L20P04-	3.5P	13.157	200	28	-	11	9	12	4	039	○
3/8-19		14.8	14.9	L10P06-	3.5P	16.662	100	28	-	14	11	14	4	039	○
		14.8	14.9	L15P06-	3.5P	16.662	150	28	-	14	11	14	4	039	○
		14.8	14.9	L20P06-	3.5P	16.662	200	28	-	14	11	14	4	039	○
1/2-14		18.5	18.55	L15P08Q	3.5P	20.955	150	35	-	18	14	17	4	039	○
		18.5	18.55	L20P08Q	3.5P	20.955	200	35	-	18	14	17	4	039	○
3/4-14		24	24.1	L15P12Q	3.5P	26.441	150	35	-	23	17	20	4	039	○
		24	24.1	L20P12Q	3.5P	26.441	200	35	-	23	17	20	4	039	○
1-11		30.2	30.25	L15P16U	3.5P	33.249	150	45	-	26	21	24	5	039	○
		30.2	30.25	L20P16U	3.5P	33.249	200	45	-	26	21	24	5	039	○
1 1/4-11		38.75	38.8	L20P20U	3.5P	41.910	200	45	-	32	26	30	5	039	○
1 1/2-11		44.6	44.7	L20P24U	3.5P	47.803	200	45	-	38	29	32	6	039	○

- Intro
- SP
- SL
- PO
- ST
- ROLL
- CARBIDE
- LONG JIS
- HAND TAPS
- EG (STI)
- SPECIAL THREADS, GAUGES
- THREAD MILLS
- DIES
- CENTER DRILLS
- Technical info

Intro

LS-PT



GP General Purpose Series

SP

Long Shank Straight Fluted Taps for Taper Pipe Threads

SL



FEATURES

Long shank general purpose for extended overhang on blind and through hole application.

For steel application at low cutting speed, also suitable for cast iron and non-ferrous materials.

PO

Recommended Tapping Speeds Depending On Materials

ISO	Vc (m/min)	ISO	Vc (m/min)	ISO	Vc (m/min)
P1	≤5 ☆	K1	≤5 ☆	N2	≤5 ☆
P2	≤5 ★	K2	≤5 ☆	N3	≤5 ☆
P3	≤5 ☆			N4	≤5 ☆
P4	≤5 ☆				

★ 1st choice ☆ suitable

ROLL

Bored Hole Ø (mm) A - B

CARBIDE

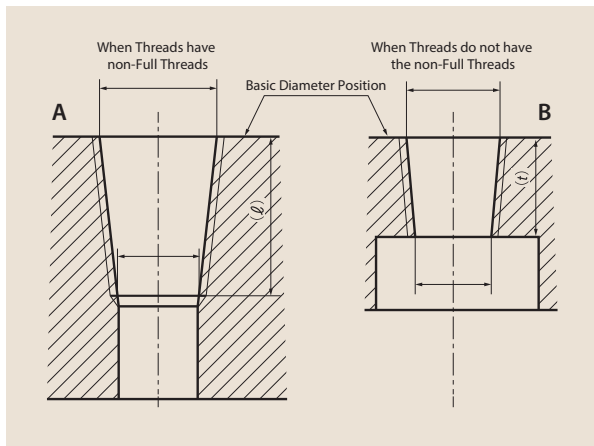

LONG

JIS

HAND TAPS

EG (STI)

SPECIAL THREADS, GAUGES

THREAD MILLS

DIES

CENTER DRILLS

Technical info

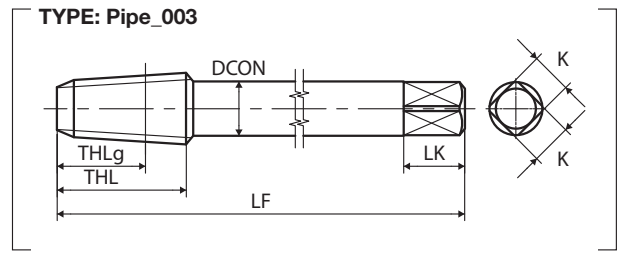
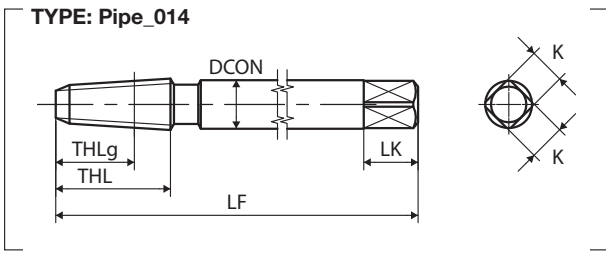

Rc(BSPT)	TCTR (tolerance)	Bored Hole Ø (mm)		Code	THCHT (chamfer)	Basic major Ø (mm)	LF (mm)	THL (mm)	THLg (mm)	LS (mm)	DCON (mm)	K (mm)	LK (mm)	NOF	Type	Stock
		A	B													
JIS																
1/16-28	II	6.1	6.2	L10T01K-8	2.5P	7.723	100	19	13	-	8	6	9	4	014	○
1/8-28	II	8.1	8.2	L10T02K	2.5P	9.728	100	19	13	-	8	6	9	4	003	●
	II	8.1	8.2	L15T02K	2.5P	9.728	150	19	13	-	8	6	9	4	003	○
1/4-19	II	8.1	8.2	L20T02K	2.5P	9.728	200	19	13	-	8	6	9	4	003	○
	II	10.7	10.9	L10T04-	2.5P	13.157	100	28	21	-	11	9	12	4	003	●
	II	10.7	10.9	L15T04-	2.5P	13.157	150	28	21	-	11	9	12	4	003	○
3/8-19	II	10.7	10.9	L20T04-	2.5P	13.157	200	28	21	-	11	9	12	4	003	○
	II	14.2	14.4	L10T06-	2.5P	16.662	100	28	21	-	14	11	14	4	003	●
	II	14.2	14.4	L12T06-	2.5P	16.662	120	28	21	-	14	11	14	4	003	○
1/2-14	II	14.2	14.4	L15T06-	2.5P	16.662	150	28	21	-	14	11	14	4	003	○
	II	14.2	14.4	L20T06-	2.5P	16.662	200	28	21	-	14	11	14	4	003	○
	II	17.6	17.9	L15T08Q	2.5P	20.955	150	35	25	-	18	14	17	4	003	○
3/4-14	II	17.6	17.9	L20T08Q	2.5P	20.955	200	35	25	-	18	14	17	4	003	○
	II	23	23.3	L15T12Q	2.5P	26.441	150	35	25	-	23	17	20	4	003	○
1 -11	II	23	23.3	L20T12Q	2.5P	26.441	200	35	25	-	23	17	20	4	003	○
	II	29	29.3	L15T16U	2.5P	33.249	150	45	32	-	26	21	24	5	003	○
1 1/4-11	II	29	29.3	L20T16U	2.5P	33.249	200	45	32	-	26	21	24	5	003	○
1 1/2-11	II	37.6	37.9	L20T20U	2.5P	41.910	200	45	32	-	32	26	30	5	003	○
2 -11	II	43.5	43.8	L20T24U	2.5P	47.803	200	45	32	-	38	29	32	6	003	○
	II	55	55.4	L20T32U	2.5P	59.614	200	50	35	-	46	35	38	6	003	○

Intro

SP

SL

PO

ST

ROLL

CARBIDE

LONG

JIS

HAND TAPS

EG (STI)

SPECIAL THREADS, GAUGES

THREAD MILLS

DIES

CENTER DRILLS

Technical info

Intro

LS-NPT



SP

GP General Purpose Series

Long Shank Straight Fluted Taps for American Taper Pipe Threads

SL



FEATURES

Long shank general purpose for extended overhang on blind and through hole application.

For steel application at low cutting speed, also suitable for cast iron and non-ferrous materials.

PO

Recommended Tapping Speeds Depending On Materials

ISO	Vc (m/min)	ISO	Vc (m/min)	ISO	Vc (m/min)
P1	≤5 ☆	K1	≤5 ☆	N2	≤5 ☆
P2	≤5 ★	K2	≤5 ☆	N3	≤5 ☆
P3	≤5 ☆	K3	≤5 ☆	N4	≤5 ☆
P4	≤5 ☆				

★ 1st choice ☆ suitable

ROLL

CARBIDE

LONG

JIS

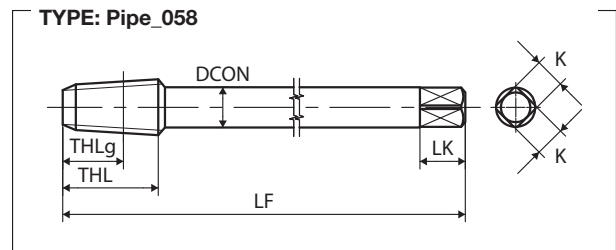
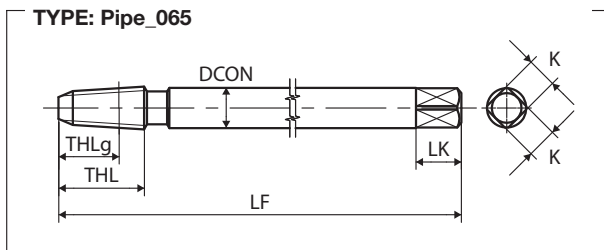

HAND TAPS

EG (STI)

SPECIAL THREADS, GAUGES

THREAD MILLS

DIES

CENTER DRILLS

Technical info

NPT	TCTR (tolerance)	Hole Ø (mm)	Hole Ø (mm)	Code	THCHT (chamfer)	Basic major Ø (mm)	LF (mm)	THL (mm)	LS (mm)	DCON (mm)	K (mm)	LK (mm)	NOF	Type	Stock
JIS															
1/16-27	ANSI G	6	6.05	TNPT01LL10	3P	7.770	100	17	-	8	6	9	4	065	○
	ANSI G	6	6.05	TNPT01LL15	3P	7.770	150	17	-	8	6	9	4	065	○
1/8-27	ANSI G	8.35	8.39	TNPT02LL10	3P	10.117	100	19	-	8	6	9	4	058	○
	ANSI G	8.35	8.39	TNPT02LL15	3P	10.117	150	19	-	8	6	9	4	058	○
1/4-18	ANSI G	10.8	10.85	TNPT04OL10	3P	13.426	100	28	-	11	9	12	4	058	○
	ANSI G	10.8	10.85	TNPT04OL15	3P	13.426	150	28	-	11	9	12	4	058	○
3/8-18	ANSI G	14.25	14.27	TNPT06OL10	3P	16.866	100	28	-	14	11	14	4	058	○
	ANSI G	14.25	14.27	TNPT06OL15	3P	16.866	150	28	-	14	11	14	4	058	○
1/2-14	ANSI G	17.5	17.6	TNPT08QL15	3P	20.980	150	35	-	18	14	17	4	058	○
3/4-14	ANSI G	22.9	22.91	TNPT12QL15	3P	26.325	150	35	-	23	17	20	4	058	○
1-11 1/2	ANSI G	28.75	28.78	TNPT16TL15	3P	32.934	150	45	-	26	21	24	5	058	○

LS-NPTF

GP General Purpose Series

Long Shank Straight Fluted Taps for American Dryseal Taper Pipe Threads



FEATURES

Long shank general purpose for extended overhang on blind and through hole application.

For steel application at low cutting speed, also suitable for cast iron and non-ferrous materials.

Recommended Tapping Speeds Depending On Materials

ISO	Vc (m/min)	ISO	Vc (m/min)	ISO	Vc (m/min)
P1	≤5 ☆	K1	≤5 ☆	N2	≤5 ☆
P2	≤5 ★	K2	≤5 ☆	N3	≤5 ☆
P3	≤5 ☆	K3	≤5 ☆	N4	≤5 ☆
P4	≤5 ☆				

★ 1st choice ☆ suitable

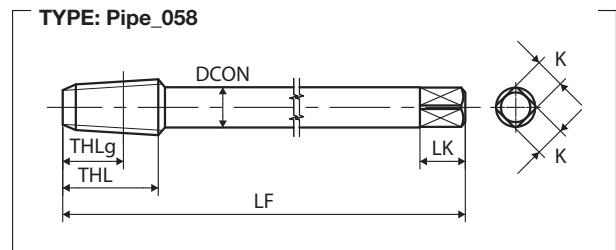
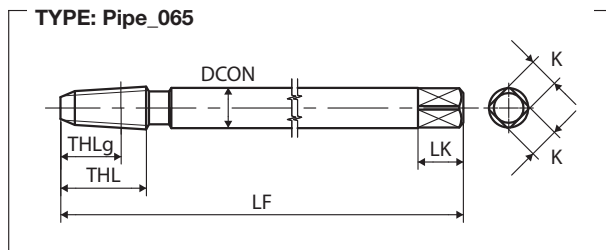

NPTF	TCTR (tolerance)	Hole Ø (mm)	Hole Ø (mm)	Code	THCHT (chamfer)	Basic major Ø (mm)	LF (mm)	THL (mm)	LS (mm)	DCON (mm)	K (mm)	LK (mm)	NOF	Type	Stock
JIS															
1/16-27	ANSI G	5.95	5.99	TNTF01LL10	3P	7.770	100	17	-	8	6	9	4	065	○
	ANSI G	5.95	5.99	TNTF01LL15	3P	7.770	150	17	-	8	6	9	4	065	○
1/8-27	ANSI G	8.3	8.34	TNTF02LL10	3P	10.117	100	19	-	8	6	9	4	058	○
	ANSI G	8.3	8.34	TNTF02LL15	3P	10.117	150	19	-	8	6	9	4	058	○
1/4-18	ANSI G	10.7	10.75	TNTF040L15	3P	13.426	150	28	-	11	9	12	4	058	○
	ANSI G	10.7	10.75	TNTF040L10	3P	13.426	100	28	-	11	9	12	4	058	○
3/8-18	ANSI G	14.1	14.17	TNTF060L10	3P	16.866	100	28	-	14	11	14	4	058	○
	ANSI G	14.1	14.17	TNTF060L15	3P	16.866	150	28	-	14	11	14	4	058	○
1/2-14	ANSI G	17.4	17.44	TNTF08QL15	3P	20.980	150	35	-	18	14	17	4	058	○
3/4-14	ANSI G	22.7	22.75	TNTF12QL15	3P	26.325	150	35	-	23	17	20	4	058	○
1-11 1/2	ANSI G	28.5	28.6	TNTF16TL15	3P	32.934	150	45	-	26	21	24	5	058	○

- Intro
- SP
- SL
- PO
- ST
- ROLL
- CARBIDE
- LONG JIS
- HAND TAPS
- EG (STI)
- SPECIAL THREADS, GAUGES
- THREAD MILLS
- DIES
- CENTER DRILLS
- Technical info

Intro

LS-HT LH

GP General Purpose Series

SP Long Shank Straight Fluted Taps for Left Hand Threads



SL



FEATURES

Long shank general purpose for extended overhang on blind and through hole application.

For steel application at low cutting speed, also suitable for cast iron and non-ferrous materials.

For left hand threads.

PO

Recommended Tapping Speeds Depending On Materials

ISO	Vc (m/min)	ISO	Vc (m/min)	ISO	Vc (m/min)
P1	5÷10 ☆	K1	5÷10 ☆	N2	5÷10 ☆
P2	5÷10 ★	K2	5÷10 ☆	N3	5÷10 ☆
P3	5÷10 ☆	K3	5÷10 ☆	N4	5÷10 ☆
P4	5÷10 ☆				

★ 1st choice ☆ suitable

ROLL

CARBIDE

LONG

JIS

HAND TAPS

EG (STI)

SPECIAL THREADS, GAUGES

THREAD MILLS

DIES

CENTER DRILLS

Technical info

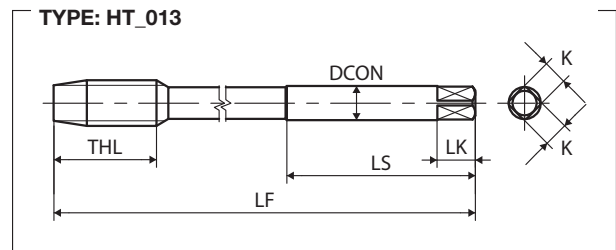
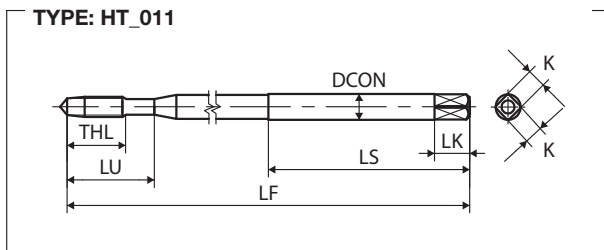

M	TCTR (tolerance)	 Hole Ø (mm)	Hole Ø (mm)	Code	THCHT (chamfer)	LF (mm)	THL (mm)	LU (mm)	LS (mm)	DCON (mm)	K (mm)	LK (mm)	NOF	Type	Stock
JIS															
M3X0.5	P1	2.5	2.56	TNFP3.0G510L	5P	100	9	18	40	4	3.2	6	3	011	○
	P1	2.5	2.56	TNFP3.0G110L	1.5P	100	9	18	40	4	3.2	6	3	011	○
M4X0.7	P2	3.3	3.38	TNFQ4.0I510L	5P	100	11	21	40	5	4	7	3	011	○
	P2	3.3	3.38	TNFQ4.0I110L	1.5P	100	11	21	40	5	4	7	3	011	○
M5X0.8	P2	4.2	4.28	TNFQ5.0K510L	5P	100	13	25	40	5.5	4.5	7	3	011	○
	P2	4.2	4.28	TNFQ5.0K110L	1.5P	100	13	25	40	5.5	4.5	7	3	011	○
M6X1	P2	5	5.09	TNFQ6.0M510L	5P	100	15	30	40	6	4.5	7	3	011	○
	P2	5	5.09	TNFQ6.0M515L	5P	150	15	30	40	6	4.5	7	3	011	○
	P2	5	5.09	TNFQ6.0M110L	1.5P	100	15	30	40	6	4.5	7	3	011	○
	P2	5	5.09	TNFQ6.0M115L	1.5P	150	15	30	40	6	4.5	7	3	011	○
M8X1.25	P2	6.8	6.85	TNMQ8.0N510L	5P	100	19	-	50	6.2	5	8	4	013	○
	P2	6.8	6.85	TNMQ8.0N515L	5P	150	19	-	50	6.2	5	8	4	013	○
	P2	6.8	6.85	TNMQ8.0N110L	1.5P	100	19	-	50	6.2	5	8	4	013	○
	P2	6.8	6.85	TNMQ8.0N115L	1.5P	150	19	-	50	6.2	5	8	4	013	○
M10X1.5	P2	8.5	8.6	TNMQ0100510L	5P	100	23	-	50	7	5.5	8	4	013	○
	P2	8.5	8.6	TNMQ0100515L	5P	150	23	-	50	7	5.5	8	4	013	○
	P2	8.5	8.6	TNMQ0100110L	1.5P	100	23	-	50	7	5.5	8	4	013	○
	P2	8.5	8.6	TNMQ0100115L	1.5P	150	23	-	50	7	5.5	8	4	013	○
M12X1.75	P2	10.3	10.36	TNMQ012P515L	5P	150	26	-	50	8.5	6.5	9	4	013	○
	P2	10.3	10.36	TNMQ012P115L	1.5P	150	26	-	50	8.5	6.5	9	4	013	○
	P2	10.3	10.36	TNMQ012P510L	5P	100	26	-	50	8.5	6.5	9	4	013	○
	P2	10.3	10.36	TNMQ012P110L	1.5P	100	26	-	50	8.5	6.5	9	4	013	○
M14X2	P2	12	12.12	TNMQ014Q515L	5P	150	26	-	60	10.5	8	11	4	013	○
	P2	12	12.12	TNMQ014Q115L	1.5P	150	26	-	60	10.5	8	11	4	013	○
M16X2	P2	14	14.12	TNMQ016Q515L	5P	150	26	-	60	12.5	10	13	4	013	○
	P2	14	14.12	TNMQ016Q520L	5P	200	26	-	60	12.5	10	13	4	013	○
	P2	14	14.12	TNMQ016Q115L	1.5P	150	26	-	60	12.5	10	13	4	013	○
	P2	14	14.12	TNMQ016Q120L	1.5P	200	26	-	60	12.5	10	13	4	013	○
M18X2.5	P3	15.5	15.63	TNMR018R515L	5P	150	33	-	70	14	11	14	4	013	○
	P3	15.5	15.63	TNMR018R115L	1.5P	150	33	-	70	14	11	14	4	013	○
M20X2.5	P3	17.5	17.63	TNMR020R515L	5P	150	33	-	70	15	12	15	4	013	○
	P3	17.5	17.63	TNMR020R520L	5P	200	33	-	70	15	12	15	4	013	○
	P3	17.5	17.63	TNMR020R115L	1.5P	150	33	-	70	15	12	15	4	013	○
	P3	17.5	17.63	TNMR020R120L	1.5P	200	33	-	70	15	12	15	4	013	○
M22X2.5	P3	19.5	19.63	TNMR022R515L	5P	150	33	-	70	17	13	16	4	013	○
	P3	19.5	19.63	TNMR022R520L	5P	200	33	-	70	17	13	16	4	013	○
	P3	19.5	19.63	TNMR022R115L	1.5P	150	33	-	70	17	13	16	4	013	○
	P3	19.5	19.63	TNMR022R120L	1.5P	200	33	-	70	17	13	16	4	013	○
M24X3	P3	21	21.13	TNMR024S515L	5P	150	39	-	80	19	15	18	4	013	○
	P3	21	21.13	TNMR024S520L	5P	200	39	-	80	19	15	18	4	013	○
	P3	21	21.13	TNMR024S115L	1.5P	150	39	-	80	19	15	18	4	013	○
	P3	21	21.13	TNMR024S120L	1.5P	200	39	-	80	19	15	18	4	013	○
M27X3	P3	24	24.13	TNMR027S520L	5P	200	39	-	80	20	15	18	4	013	○
	P3	24	24.13	TNMR027S120L	1.5P	200	39	-	80	20	15	18	4	013	○

Intro

SP

SL

PO

ST

ROLL

CARBIDE

LONG

JIS

HAND TAPS

EG (STI)

SPECIAL THREADS, GAUGES

THREAD MILLS

DIES

CENTER DRILLS

Technical info

Long Taps

Intro

M	TCTR (tolerance)	\varnothing (mm)	Hole \varnothing (mm)	Code	THCHT (chamfer)	LF (mm)	THL (mm)	LU (mm)	LS (mm)	DCON (mm)	K (mm)	LK (mm)	NOF	Type	Stock
JIS															

SP

M30X3.5	P4	26.5	26.63	TNMS030T520L	5P	200	46	-	80	23	17	20	4	013	○
	P4	26.5	26.63	TNMS030T120L	1.5P	200	46	-	80	23	17	20	4	013	○
	P4	26.5	26.63	TNMS030T525L	5P	250	46	-	80	23	17	20	4	013	○
	P4	26.5	26.63	TNMS030T125L	1.5P	250	46	-	80	23	17	20	4	013	○

SL

MF	TCTR (tolerance)	\varnothing (mm)	Hole \varnothing (mm)	Code	THCHT (chamfer)	LF (mm)	THL (mm)	LU (mm)	LS (mm)	DCON (mm)	K (mm)	LK (mm)	NOF	Type	Stock
JIS															

PO

M10X1.25	P2	8.8	8.85	TNMQ010N515L	5P	150	23	-	50	7	5.5	8	4	013	○
	P2	8.8	8.85	TNMQ010N115L	1.5P	150	23	-	50	7	5.5	8	4	013	○
M12X1.5	P2	10.5	10.6	TNMQ0120515L	5P	150	26	-	50	8.5	6.5	9	4	013	○
	P2	10.5	10.6	TNMQ0120115L	1.5P	150	26	-	50	8.5	6.5	9	4	013	○

ST

M12X1.25	P2	10.8	10.85	TNMQ012N515L	5P	150	26	-	50	8.5	6.5	9	4	013	○
	P2	10.8	10.85	TNMQ012N115L	1.5P	150	26	-	50	8.5	6.5	9	4	013	○
M14X1.5	P2	12.5	12.6	TNMQ0140515L	5P	150	26	-	60	10.5	8	11	4	013	○
	P2	12.5	12.6	TNMQ0140115L	1.5P	150	26	-	60	10.5	8	11	4	013	○

ROLL

M16X1.5	P2	14.5	14.6	TNMQ0160515L	5P	150	26	-	60	12.5	10	13	4	013	○
	P2	14.5	14.6	TNMQ0160115L	1.5P	150	26	-	60	12.5	10	13	4	013	○
M18X1.5	P2	16.5	16.6	TNMQ0180515L	5P	150	33	-	70	14	11	14	4	013	○
	P2	16.5	16.6	TNMQ0180115L	1.5P	150	33	-	70	14	11	14	4	013	○

CARBIDE

M20X1.5	P3	18.5	18.6	TNMR0200515L	5P	150	33	-	70	15	12	15	4	013	○
	P3	18.5	18.6	TNMR0200520L	5P	200	33	-	70	15	12	15	4	013	○
	P3	18.5	18.6	TNMR0200115L	1.5P	150	33	-	70	15	12	15	4	013	○
	P3	18.5	18.6	TNMR0200120L	1.5P	200	33	-	70	15	12	15	4	013	○

LONG

JIS

M22X1.5	P3	20.5	20.6	TNMR0220520L	5P	200	33	-	70	17	13	16	4	013	○
	P3	20.5	20.6	TNMR0220120L	1.5P	200	33	-	70	17	13	16	4	013	○
M24X1.5	P3	22.5	22.6	TNMR0240520L	5P	200	39	-	80	19	15	18	4	013	○

HAND
TAPS

M27X1.5	P3	25.5	25.6	TNMR0270520L	5P	200	39	-	80	20	15	18	4	013	○
	P3	25.5	25.6	TNMR0270120L	1.5P	200	39	-	80	20	15	18	4	013	○
M30X3	P3	27	27.13	TNMR030S520L	5P	200	46	-	80	23	17	20	4	013	○
M30X2	P3	28	28.12	TNMR030Q520L	5P	200	46	-	80	23	17	20	4	013	○

EG (STI)

M30X1.5	P3	28.5	28.6	TNMR0300520L	5P	200	46	-	80	23	17	20	4	013	○
	P3	28.5	28.6	TNMR0300120L	1.5P	200	46	-	80	23	17	20	4	013	○

SPECIAL
THREADS,
GAUGES

THREAD
MILLS

DIES

CENTER
DRILLS

Technical
info

Intro

SP

SL

PO

ST

ROLL

CARBIDE

LONG

JIS

HAND
TAPS

EG (STI)

SPECIAL
THREADS,
GAUGES

THREAD
MILLS

DIES

CENTER
DRILLS

Technical
info

Intro

LS-HT V

GP General Purpose Series

SP Long Shank Straight Fluted Taps, Coated



SL



PO

Recommended Tapping Speeds Depending On Materials

ISO	Vc (m/min)	ISO	Vc (m/min)	ISO	Vc (m/min)
P2	10÷20 ★	K1	8÷15 ☆	N2	10÷20 ☆
P3	10÷20 ★	K2	8÷15 ☆	N3	10÷20 ☆
P4	8÷15 ☆	K3	8÷15 ☆	N4	10÷20 ☆

★ 1st choice ☆ suitable

ROLL

CARBIDE

LONG
JIS

HAND
TAPS

EG (STI)

SPECIAL
THREADS,
GAUGES

THREAD
MILLS

DIES

CENTER
DRILLS

Technical
info

FEATURES

Long shank general purpose for extended overhang on blind and through hole application.

For steel application, also suitable for cast iron and non-ferrous materials.

Adopting suitable coating to improve performances.

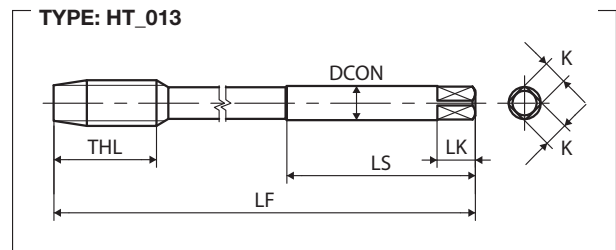
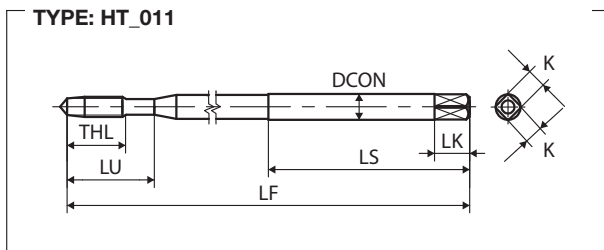

M	TCTR (tolerance)	 Hole Ø (mm)	Hole Ø (mm)	Code	THCHT (chamfer)	LF (mm)	THL (mm)	LU (mm)	LS (mm)	DCON (mm)	K (mm)	LK (mm)	NOF	Type	Stock
JIS															
M3X0.5	P1	2.5	2.56	TNFP3.0G510V	5P	100	9	18	40	4	3.2	6	3	011	○
	P1	2.5	2.56	TNFP3.0G110V	1.5P	100	9	18	40	4	3.2	6	3	011	○
M4X0.7	P2	3.3	3.38	TNFP4.0I510V	5P	100	11	21	40	5	4	7	3	011	○
	P2	3.3	3.38	TNFP4.0I110V	1.5P	100	11	21	40	5	4	7	3	011	○
M5X0.8	P2	4.2	4.28	TNFP5.0K510V	5P	100	13	25	40	5.5	4.5	7	3	011	○
	P2	4.2	4.28	TNFP5.0K110V	1.5P	100	13	25	40	5.5	4.5	7	3	011	○
M6X1	P2	5	5.09	TNFP6.0M510V	5P	100	15	30	40	6	4.5	7	3	011	○
	P2	5	5.09	TNFP6.0M515V	5P	150	15	30	40	6	4.5	7	3	011	○
	P2	5	5.09	TNFP6.0M110V	1.5P	100	15	30	40	6	4.5	7	3	011	○
	P2	5	5.09	TNFP6.0M115V	1.5P	150	15	30	40	6	4.5	7	3	011	○
M8X1.25	P2	6.8	6.85	TNMQ8.0N510V	5P	100	19	-	50	6.2	5	8	4	013	○
	P2	6.8	6.85	TNMQ8.0N515V	5P	150	19	-	50	6.2	5	8	4	013	○
	P2	6.8	6.85	TNMQ8.0N110V	1.5P	100	19	-	50	6.2	5	8	4	013	○
	P2	6.8	6.85	TNMQ8.0N115V	1.5P	150	19	-	50	6.2	5	8	4	013	○
M10X1.5	P2	8.5	8.6	TNMQ10.0O510V	5P	100	23	-	50	7	5.5	8	4	013	○
	P2	8.5	8.6	TNMQ10.0O515V	5P	150	23	-	50	7	5.5	8	4	013	○
	P2	8.5	8.6	TNMQ10.0O110V	1.5P	100	23	-	50	7	5.5	8	4	013	○
	P2	8.5	8.6	TNMQ10.0O115V	1.5P	150	23	-	50	7	5.5	8	4	013	○
M12X1.75	P2	10.3	10.36	TNMQ12.0P510V	5P	100	26	-	50	8.5	6.5	9	4	013	○
	P2	10.3	10.36	TNMQ12.0P515V	5P	150	26	-	50	8.5	6.5	9	4	013	○
	P2	10.3	10.36	TNMQ12.0P110V	1.5P	100	26	-	50	8.5	6.5	9	4	013	○
	P2	10.3	10.36	TNMQ12.0P115V	1.5P	150	26	-	50	8.5	6.5	9	4	013	○
JIS															
M10X1.25	P2	8.8	8.85	TNMQ10.0N510V	5P	100	23	-	50	7	5.5	8	4	013	○
	P2	8.8	8.85	TNMQ10.0N515V	5P	150	23	-	50	7	5.5	8	4	013	○
	P2	8.8	8.85	TNMQ10.0N110V	1.5P	100	23	-	50	7	5.5	8	4	013	○
	P2	8.8	8.85	TNMQ10.0N115V	1.5P	150	23	-	50	7	5.5	8	4	013	○
M12X1.5	P2	10.5	10.6	TNMQ12.0O510V	5P	100	26	-	50	8.5	6.5	9	4	013	○
	P2	10.5	10.6	TNMQ12.0O515V	5P	150	26	-	50	8.5	6.5	9	4	013	○
	P2	10.5	10.6	TNMQ12.0O110V	1.5P	100	26	-	50	8.5	6.5	9	4	013	○
M12X1.25	P2	10.8	10.85	TNMQ12.0N510V	5P	100	26	-	50	8.5	6.5	9	4	013	○
	P2	10.8	10.85	TNMQ12.0N515V	5P	150	26	-	50	8.5	6.5	9	4	013	○
	P2	10.8	10.85	TNMQ12.0N110V	1.5P	100	26	-	50	8.5	6.5	9	4	013	○
	P2	10.8	10.85	TNMQ12.0N115V	1.5P	150	26	-	50	8.5	6.5	9	4	013	○

Intro

SP

SL

PO

ST

ROLL

CARBIDE

LONG
JIS

HAND
TAPS

EG (STI)

SPECIAL
THREADS,
GAUGES

THREAD
MILLS

DIES

CENTER
DRILLS

Technical
info

Intro

MC-HT

GP General Purpose Series

Long Shank Straight Fluted Taps with Axial (Blind) and Radial (Through) Coolant Holes



SP

SL



FEATURES

Long shank general purpose for extended overhang on blind and through hole application.

For steel application, also suitable for cast iron and non-ferrous materials.

1.5P chamfer with axial oil hole for blind hole application, 5P chamfer with radial coolant holes for through hole application.

PO

RECOMMENDED TAPPING SPEEDS DEPENDING ON MATERIALS

ISO	Vc (m/min)	ISO	Vc (m/min)	ISO	Vc (m/min)
P1	5÷10 ☆	K1	5÷10 ☆	N2	5÷10 ☆
P2	5÷10 ★	K2	5÷10 ☆	N3	5÷10 ☆
P3	5÷10 ☆	K3	5÷10 ☆	N4	5÷10 ☆
P4	5÷10 ☆				

★ 1st choice ☆ suitable

ROLL

CARBIDE

LONG
JIS

HAND
TAPS

EG (STI)

SPECIAL
THREADS,
GAUGES

THREAD
MILLS

DIES

CENTER
DRILLS

Technical
info

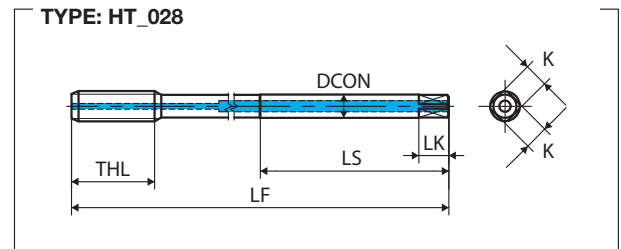
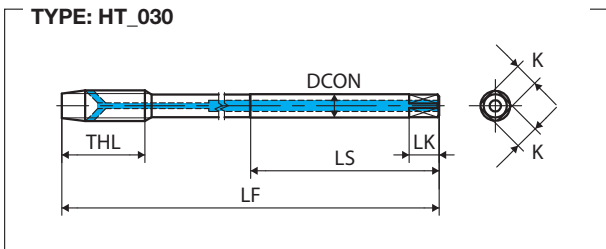
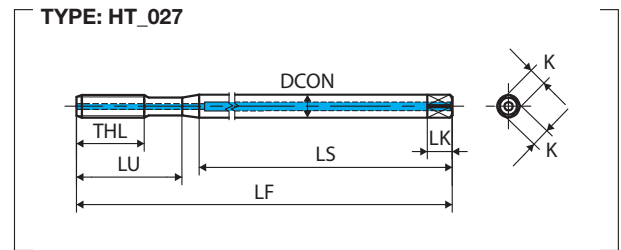
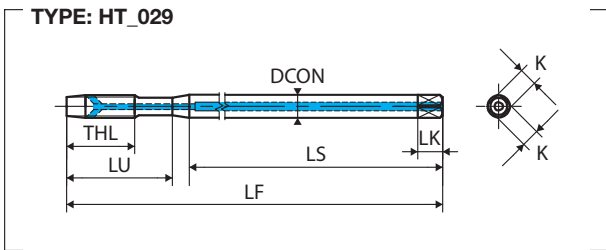

M	TCTR (tolerance)	 Hole Ø (mm)	Hole Ø (mm)	Code	THCHT (chamfer)	LF (mm)	THL (mm)	LU (mm)	LS (mm)	DCON (mm)	K (mm)	LK (mm)	NOF	Type	Stock
JIS															
M6X1	P2	5	5.09	ML106.0M5-Q	5P	100	19	28	40	6	4.5	7	4	029	○
	P2	5	5.09	ML156.0M5-Q	5P	150	19	28	40	6	4.5	7	4	029	○
	P2	5	5.09	ML106.0M1-Q	1.5P	100	19	28	40	6	4.5	7	4	027	○
	P2	5	5.09	ML156.0M1-Q	1.5P	150	19	28	40	6	4.5	7	4	027	○
M8X1.25	P2	6.8	6.85	ML108.0N5-Q	5P	100	22	-	50	6.2	5	8	4	030	○
	P2	6.8	6.85	ML158.0N5-Q	5P	150	22	-	50	6.2	5	8	4	030	○
	P2	6.8	6.85	ML108.0N1-Q	1.5P	100	22	-	50	6.2	5	8	4	028	○
	P2	6.8	6.85	ML158.0N1-Q	1.5P	150	22	-	50	6.2	5	8	4	028	○
M10X1.5	P2	8.5	8.6	ML1001005-Q	5P	100	24	-	50	7	5.5	8	4	030	○
	P2	8.5	8.6	ML1501005-Q	5P	150	24	-	50	7	5.5	8	4	030	○
	P2	8.5	8.6	ML1001001-Q	1.5P	100	24	-	50	7	5.5	8	4	028	○
	P2	8.5	8.6	ML1501001-Q	1.5P	150	24	-	50	7	5.5	8	4	028	○
M12X1.75	P2	10.3	10.36	ML10012P5-Q	5P	100	29	-	50	8.5	6.5	9	4	030	○
	P2	10.3	10.36	ML15012P5-Q	5P	150	29	-	50	8.5	6.5	9	4	030	○
	P2	10.3	10.36	ML20012P5-Q	5P	200	29	-	50	8.5	6.5	9	4	030	○
	P2	10.3	10.36	ML10012P1-Q	1.5P	100	29	-	50	8.5	6.5	9	4	028	○
	P2	10.3	10.36	ML15012P1-Q	1.5P	150	29	-	50	8.5	6.5	9	4	028	○
	P2	10.3	10.36	ML20012P1-Q	1.5P	200	29	-	50	8.5	6.5	9	4	028	○
M14X2	P2	12	12.12	ML15014Q5-Q	5P	150	30	-	60	10.5	8	11	4	030	○
	P2	12	12.12	ML20014Q5-Q	5P	200	30	-	60	10.5	8	11	4	030	○
	P2	12	12.12	ML15014Q1-Q	1.5P	150	30	-	60	10.5	8	11	4	028	○
	P2	12	12.12	ML20014Q1-Q	1.5P	200	30	-	60	10.5	8	11	4	028	○
M16X2	P2	14	14.12	ML15016Q5-Q	5P	150	32	-	60	12.5	10	13	4	030	○
	P2	14	14.12	ML20016Q5-Q	5P	200	32	-	60	12.5	10	13	4	030	○
	P2	14	14.12	ML15016Q1-Q	1.5P	150	32	-	60	12.5	10	13	4	028	○
	P2	14	14.12	ML20016Q1-Q	1.5P	200	32	-	60	12.5	10	13	4	028	○
M18X2.5	P3	15.5	15.63	ML15018R5-R	5P	150	37	-	70	14	11	14	4	030	○
	P3	15.5	15.63	ML20018R5-R	5P	200	37	-	70	14	11	14	4	030	○
	P3	15.5	15.63	ML15018R1-R	1.5P	150	37	-	70	14	11	14	4	028	○
	P3	15.5	15.63	ML20018R1-R	1.5P	200	37	-	70	14	11	14	4	028	○
M20X2.5	P3	17.5	17.63	ML15020R5-R	5P	150	37	-	70	15	12	15	4	030	○
	P3	17.5	17.63	ML20020R5-R	5P	200	37	-	70	15	12	15	4	030	○
	P3	17.5	17.63	ML15020R1-R	1.5P	150	37	-	70	15	12	15	4	028	○
	P3	17.5	17.63	ML20020R1-R	1.5P	200	37	-	70	15	12	15	4	028	○
M22X2.5	P3	19.5	19.63	ML15022R5-R	5P	150	38	-	70	17	13	16	4	030	○
	P3	19.5	19.63	ML20022R5-R	5P	200	38	-	70	17	13	16	4	030	○
	P3	19.5	19.63	ML15022R1-R	1.5P	150	38	-	70	17	13	16	4	028	○
	P3	19.5	19.63	ML20022R1-R	1.5P	200	38	-	70	17	13	16	4	028	○
M24X3	P3	21	21.13	ML15024S5-R	5P	150	45	-	80	19	15	18	4	030	○
	P3	21	21.13	ML20024S5-R	5P	200	45	-	80	19	15	18	4	030	○
	P3	21	21.13	ML15024S1-R	1.5P	150	45	-	80	19	15	18	4	028	○
	P3	21	21.13	ML20024S1-R	1.5P	200	45	-	80	19	15	18	4	028	○
M27X3	P3	24	24.13	ML20027S5-R	5P	200	45	-	80	20	15	18	4	030	○
	P3	24	24.13	ML20027S1-R	1.5P	200	45	-	80	20	15	18	4	028	○
	P3	24	24.13	ML25027S5-R	5P	250	45	-	80	20	15	18	4	030	○
	P3	24	24.13	ML25027S1-R	1.5P	250	45	-	80	20	15	18	4	028	○

Intro

SP

SL

PO

ST

ROLL

CARBIDE

LONG
JIS

HAND
TAPS

EG (STI)

SPECIAL
THREADS,
GAUGES

THREAD
MILLS

DIES

CENTER
DRILLS

Technical
info

Long Taps

Intro

M	TCTR (tolerance)	\varnothing (mm)	Hole \varnothing (mm)	Code	THCHT (chamfer)	LF (mm)	THL (mm)	LU (mm)	LS (mm)	DCON (mm)	K (mm)	LK (mm)	NOF	Type	Stock
JIS															

SP

M30X3.5	P4	26.5	26.63	ML20030T5-S	5P	200	48	-	80	23	17	20	4	030	○
	P4	26.5	26.63	ML20030T1-S	1.5P	200	48	-	80	23	17	20	4	028	○
	P4	26.5	26.63	ML25030T5-S	5P	250	48	-	80	23	17	20	4	030	○
	P4	26.5	26.63	ML25030T1-S	1.5P	250	48	-	80	23	17	20	4	028	○

SL

MF	TCTR (tolerance)	\varnothing (mm)	Hole \varnothing (mm)	Code	THCHT (chamfer)	LF (mm)	THL (mm)	LU (mm)	LS (mm)	DCON (mm)	K (mm)	LK (mm)	NOF	Type	Stock
JIS															

PO

M10X1.25	P2	8.8	8.85	ML10010N5-Q	5P	100	20	-	50	7	5.5	8	4	030	○
	P2	8.8	8.85	ML15010N5-Q	5P	150	20	-	50	7	5.5	8	4	030	○
	P2	8.8	8.85	ML10010N1-Q	1.5P	100	20	-	50	7	5.5	8	4	028	○
	P2	8.8	8.85	ML15010N1-Q	1.5P	150	20	-	50	7	5.5	8	4	028	○

ST

M12X1.5	P2	10.5	10.6	ML1001205-Q	5P	100	29	-	50	8.5	6.5	9	4	030	○
	P2	10.5	10.6	ML1501205-Q	5P	150	29	-	50	8.5	6.5	9	4	030	○
	P2	10.5	10.6	ML2001205-Q	5P	200	29	-	50	8.5	6.5	9	4	030	○
	P2	10.5	10.6	ML1001201-Q	1.5P	100	29	-	50	8.5	6.5	9	4	028	○
	P2	10.5	10.6	ML1501201-Q	1.5P	150	29	-	50	8.5	6.5	9	4	028	○

ROLL

M12X1.25	P2	10.8	10.85	ML10012N5-Q	5P	100	24	-	50	8.5	6.5	9	4	030	○
	P2	10.8	10.85	ML15012N5-Q	5P	150	24	-	50	8.5	6.5	9	4	030	○
	P2	10.8	10.85	ML20012N5-Q	5P	200	24	-	50	8.5	6.5	9	4	030	○
	P2	10.8	10.85	ML10012N1-Q	1.5P	100	24	-	50	8.5	6.5	9	4	028	○
	P2	10.8	10.85	ML15012N1-Q	1.5P	150	24	-	50	8.5	6.5	9	4	028	○

CARBIDE

M14X1.5	P2	12.5	12.6	ML1501405-Q	5P	150	30	-	60	10.5	8	11	4	030	○
	P2	12.5	12.6	ML2001405-Q	5P	200	30	-	60	10.5	8	11	4	030	○
	P2	12.5	12.6	ML1501401-Q	1.5P	150	30	-	60	10.5	8	11	4	028	○
	P2	12.5	12.6	ML2001401-Q	1.5P	200	30	-	60	10.5	8	11	4	028	○
	P2	12.5	12.6	ML20012N1-Q	1.5P	200	24	-	50	8.5	6.5	9	4	028	○

LONG

JIS

M16X1.5	P2	14.5	14.6	ML1501605-Q	5P	150	32	-	60	12.5	10	13	4	030	○
	P2	14.5	14.6	ML2001605-Q	5P	200	32	-	60	12.5	10	13	4	030	○
	P2	14.5	14.6	ML1501601-Q	1.5P	150	32	-	60	12.5	10	13	4	028	○
	P2	14.5	14.6	ML2001601-Q	1.5P	200	32	-	60	12.5	10	13	4	028	○

HAND
TAPS

EG (STI)

M18X1.5	P2	16.5	16.6	ML1501805-Q	5P	150	29	-	70	14	11	14	4	030	○
	P2	16.5	16.6	ML2001805-Q	5P	200	29	-	70	14	11	14	4	030	○
	P2	16.5	16.6	ML1501801-Q	1.5P	150	29	-	70	14	11	14	4	028	○
	P2	16.5	16.6	ML2001801-Q	1.5P	200	29	-	70	14	11	14	4	028	○

SPECIAL
THREADS,
GAUGES

THREAD
MILLS

M20X1.5	P3	18.5	18.6	ML1502005-R	5P	150	29	-	70	15	12	15	4	030	○
	P3	18.5	18.6	ML2002005-R	5P	200	29	-	70	15	12	15	4	030	○
	P3	18.5	18.6	ML1502001-R	1.5P	150	29	-	70	15	12	15	4	028	○
	P3	18.5	18.6	ML2002001-R	1.5P	200	29	-	70	15	12	15	4	028	○

DIES

M22X1.5	P3	20.5	20.6	ML1502205-R	5P	150	33	-	70	17	13	16	4	030	○
	P3	20.5	20.6	ML2002205-R	5P	200	33	-	70	17	13	16	4	030	○
	P3	20.5	20.6	ML1502201-R	1.5P	150	33	-	70	17	13	16	4	028	○
	P3	20.5	20.6	ML2002201-R	1.5P	200	33	-	70	17	13	16	4	028	○

CENTER
DRILLS

M24X1.5	P3	22.5	22.6	ML1502405-R	5P	150	35	-	80	19	15	18	4	030	○
	P3	22.5	22.6	ML2002405-R	5P	200	35	-	80	19	15	18	4	030	○
	P3	22.5	22.6	ML1502401-R	1.5P	150	35	-	80	19	15	18	4	028	○
	P3	22.5	22.6	ML2002401-R	1.5P	200	35	-	80	19	15	18	4	028	○

Technical
info

MF	TCTR (tolerance)	∅ (mm)	Hole ∅ (mm)	Code	THCHT (chamfer)	LF (mm)	THL (mm)	LU (mm)	LS (mm)	DCON (mm)	K (mm)	LK (mm)	NOF	Type	Stock
JIS															
M27X1.5	P3	25.5	25.6	ML2002705-R	5P	200	37	-	80	20	15	18	4	030	○
	P3	25.5	25.6	ML2002701-R	1.5P	200	37	-	80	20	15	18	4	028	○
	P3	25.5	25.6	ML2502705-R	5P	250	37	-	80	20	15	18	4	030	○
	P3	25.5	25.6	ML2502701-R	1.5P	250	37	-	80	20	15	18	4	028	○
M30X1.5	P3	28.5	28.6	ML2003005-R	5P	200	37	-	80	23	17	20	4	030	○
	P3	28.5	28.6	ML2003001-R	1.5P	200	37	-	80	23	17	20	4	028	○
	P3	28.5	28.6	ML2503005-R	5P	250	37	-	80	23	17	20	4	030	○
	P3	28.5	28.6	ML2503001-R	1.5P	250	37	-	80	23	17	20	4	028	○

Intro

SP

SL

PO

ST

ROLL

CARBIDE

LONG

JIS

HAND
TAPS

EG (STI)

SPECIAL
THREADS,
GAUGESTHREAD
MILLS

DIES

CENTER
DRILLSTechnical
info

Intro

LS-N-RZ

GP General Purpose Series

SP Long Shank Thread Forming Taps for Steel

SL



PO

Recommended Tapping Speeds Depending On Materials

ISO	Vc (m/min)
P1	5÷15 ★
P2	5÷10 ★

ST

★ 1st choice ☆ suitable

ROLL

CARBIDE

LONG
JIS

HAND
TAPS

EG (STI)

SPECIAL
THREADS,
GAUGES

THREAD
MILLS

DIES

CENTER
DRILLS

Technical
info



FEATURES

Long shank roll for extended overhang on blind and through hole application.

Suitable for soft structural steel and medium-low carbon steel application.

OX treatment reduces welding troubles.

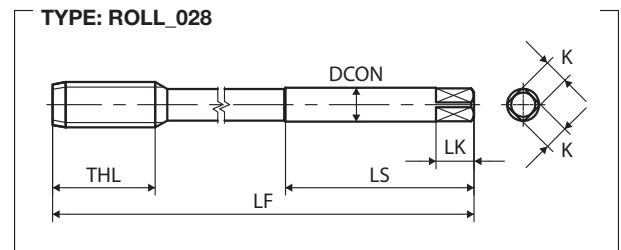
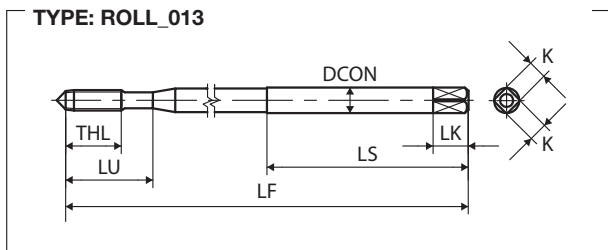

M	TCTR (tolerance)	\varnothing (mm)	Hole \varnothing (mm)	Code	THCHT (chamfer)	LF (mm)	THL (mm)	LU (mm)	LS (mm)	DCON (mm)	K (mm)	LK (mm)	NOF	Type	Stock
JIS															
M3X0.5	G5	2.78	2.56	NRZF53.0GP10	4P	100	9	18	40	4	3.2	6	4(4)	013	○
	G5	2.78	2.56	NRZF53.0GB10	2P	100	9	18	40	4	3.2	6	4(4)	013	○
	G6(G5+13)	2.79	2.56	NRZF63.0GP10	4P	100	9	18	40	4	3.2	6	4(4)	013	○
	G6(G5+13)	2.79	2.56	NRZF63.0GB10	2P	100	9	18	40	4	3.2	6	4(4)	013	○
M4X0.7	G6	3.69	3.38	NRZF64.0IP10	4P	100	11	21	40	5	4	7	4(4)	013	○
	G6	3.69	3.38	NRZF64.0IB10	2P	100	11	21	40	5	4	7	4(4)	013	○
	G7(G6+13)	3.7	3.38	NRZF74.0IP10	4P	100	11	21	40	5	4	7	4(4)	013	○
	G7(G6+13)	3.7	3.38	NRZF74.0IB10	2P	100	11	21	40	5	4	7	4(4)	013	○
M5X0.8	G6	4.63	4.28	NRZF65.0KP10	4P	100	13	25	40	5.5	4.5	7	4(4)	013	○
	G6	4.63	4.28	NRZF65.0KB10	2P	100	13	25	40	5.5	4.5	7	4(4)	013	○
	G7(G6+13)	4.64	4.28	NRZF75.0KP10	4P	100	13	25	40	5.5	4.5	7	4(4)	013	○
	G7(G6+13)	4.64	4.28	NRZF75.0KB10	2P	100	13	25	40	5.5	4.5	7	4(4)	013	○
M6X1	G7	5.54	5.09	NRZF76.0MP10	4P	100	15	30	40	6	4.5	7	4(4)	013	○
	G7	5.54	5.09	NRZF76.0MP15	4P	150	15	30	40	6	4.5	7	4(4)	013	○
	G7	5.54	5.09	NRZF76.0MB10	2P	100	15	30	40	6	4.5	7	4(4)	013	○
	G7	5.54	5.09	NRZF76.0MB15	2P	150	15	30	40	6	4.5	7	4(4)	013	○
	G8(G7+13)	5.55	5.09	NRZF86.0MP10	4P	100	15	30	40	6	4.5	7	4(4)	013	○
	G8(G7+13)	5.55	5.09	NRZF86.0MB10	2P	100	15	30	40	6	4.5	7	4(4)	013	○
	G8(G7+13)	5.55	5.09	NRZF86.0MP15	4P	150	15	30	40	6	4.5	7	4(4)	013	○
	G8(G7+13)	5.55	5.09	NRZF86.0MB15	2P	150	15	30	40	6	4.5	7	4(4)	013	○
M8X1.25	G7	7.46	6.85	NRZM78.0NP10	4P	100	19	-	50	6.2	5	8	3(6)	028	○
	G7	7.46	6.85	NRZM78.0NP15	4P	150	19	-	50	6.2	5	8	3(6)	028	○
	G7	7.46	6.85	NRZM78.0NB10	2P	100	19	-	50	6.2	5	8	3(6)	028	○
	G7	7.46	6.85	NRZM78.0NB15	2P	150	19	-	50	6.2	5	8	3(6)	028	○
M10X1.5	G7	9.3	8.6	NRZM70100P10	4P	100	23	-	50	7	5.5	8	4(8)	028	○
	G7	9.3	8.6	NRZM70100P15	4P	150	23	-	50	7	5.5	8	4(8)	028	○
	G7	9.3	8.6	NRZM70100B10	2P	100	23	-	50	7	5.5	8	4(8)	028	○
	G7	9.3	8.6	NRZM70100B15	2P	150	23	-	50	7	5.5	8	4(8)	028	○
JIS															
M10X1.25	G7	9.42	8.85	NRZM7010NP15	4P	150	23	-	50	7	5.5	8	4(8)	028	○
	G7	9.42	8.85	NRZM7010NB15	2P	150	23	-	50	7	5.5	8	4(8)	028	○

Intro

SP

SL

PO

ST

ROLL

CARBIDE

LONG

JIS

HAND
TAPS

EG (STI)

SPECIAL
THREADS,
GAUGESTHREAD
MILLS

DIES

CENTER
DRILLSTechnical
info

Intro

LS-N-RS

GP General Purpose Series

SP

Long Shank Thread Forming Taps for Non-Ferrous Materials

SL



PO

Recommended Tapping Speeds Depending On Materials

ISO	Vc (m/min)
N1	5÷15 ★
N2	5÷15 ★
N3	5÷15 ★

★ 1st choice ☆ suitable

ST

ROLL

CARBIDE

LONG

JIS

HAND TAPS

EG (STI)

SPECIAL THREADS, GAUGES

THREAD MILLS

DIES

CENTER DRILLS

Technical info



FEATURES

Long shank roll for extended overhang on blind and through hole application.

Specific design for non-ferrous materials.

NI treatment improves tool life.

TYPE: ROLL_013

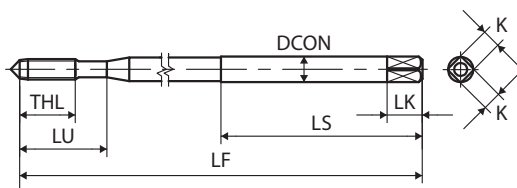

TYPE: ROLL_028

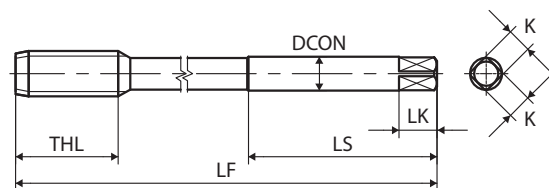

M	TCTR (tolerance)	\varnothing (mm)	Hole \varnothing (mm)	Code	THCHT (chamfer)	LF (mm)	THL (mm)	LU (mm)	LS (mm)	DCON (mm)	K (mm)	LK (mm)	NOF	Type	Stock
JIS															
M3X0.5	G5	2.78	2.56	NRSF53.0GP10	4P	100	9	14	40	4	3.2	6	1(4)	013	○
	G5	2.78	2.56	NRSF53.0GB10	2P	100	9	14	40	4	3.2	6	1(4)	013	○
	G6(G5+13)	2.79	2.56	NRSF63.0GP10	4P	100	9	18	40	4	3.2	6	1(4)	013	○
	G6(G5+13)	2.79	2.56	NRSF63.0GB10	2P	100	9	18	40	4	3.2	6	1(4)	013	○
M4X0.7	G6	3.69	3.38	NRSF64.0IP10	4P	100	11	21	40	5	4	7	1(4)	013	○
	G6	3.69	3.38	NRSF64.0IB10	2P	100	11	21	40	5	4	7	1(4)	013	○
	G7(G6+13)	3.7	3.38	NRSF74.0IP10	4P	100	11	21	40	5	4	7	1(4)	013	○
	G7(G6+13)	3.7	3.38	NRSF74.0IB10	2P	100	11	21	40	5	4	7	1(4)	013	○
M5X0.8	G6	4.63	4.28	NRSF65.0KP10	4P	100	13	25	40	5.5	4.5	7	1(4)	013	○
	G6	4.63	4.28	NRSF65.0KB10	2P	100	13	25	40	5.5	4.5	7	1(4)	013	○
	G7(G6+13)	4.64	4.28	NRSF75.0KP10	4P	100	13	25	40	5.5	4.5	7	1(4)	013	○
	G7(G6+13)	4.64	4.28	NRSF75.0KB10	2P	100	13	25	40	5.5	4.5	7	1(4)	013	○
M6X1	G7	5.54	5.09	NRSF76.0MP10	4P	100	15	30	40	6	4.5	7	1(4)	013	○
	G7	5.54	5.09	NRSF76.0MP15	4P	150	15	30	40	6	4.5	7	1(4)	013	○
	G7	5.54	5.09	NRSF76.0MB10	2P	100	15	30	40	6	4.5	7	1(4)	013	○
	G7	5.54	5.09	NRSF76.0MB15	2P	150	15	30	40	6	4.5	7	1(4)	013	○
	G8(G7+13)	5.55	5.09	NRSF86.0MP10	4P	100	15	30	40	6	4.5	7	1(4)	013	○
	G8(G7+13)	5.55	5.09	NRSF86.0MP15	4P	150	15	30	40	6	4.5	7	1(4)	013	○
	G8(G7+13)	5.55	5.09	NRSF86.0MB10	2P	100	15	30	40	6	4.5	7	1(4)	013	○
	G8(G7+13)	5.55	5.09	NRSF86.0MB15	2P	150	15	30	40	6	4.5	7	1(4)	013	○
M8X1.25	G7	7.46	6.85	NRSM78.0NP10	4P	100	19	-	50	6.2	5	8	1(6)	028	○
	G7	7.46	6.85	NRSM78.0NP15	4P	150	19	-	50	6.2	5	8	1(6)	028	○
	G7	7.46	6.85	NRSM78.0NB10	2P	100	19	-	50	6.2	5	8	1(6)	028	○
	G7	7.46	6.85	NRSM78.0NB15	2P	150	19	-	50	6.2	5	8	1(6)	028	○
M10X1.5	G7	9.3	8.6	NRSM70100P10	4P	100	23	-	50	7	5.5	8	1(6)	028	○
	G7	9.3	8.6	NRSM70100P15	4P	150	23	-	50	7	5.5	8	1(6)	028	○
	G7	9.3	8.6	NRSM70100B10	2P	100	23	-	50	7	5.5	8	1(6)	028	○
	G7	9.3	8.6	NRSM70100B15	2P	150	23	-	50	7	5.5	8	1(6)	028	○
JIS															
M10X1.25	G7	9.42	8.85	NRSM7010NB10	2P	100	23	-	50	7	5.5	8	1(6)	028	○
	G7	9.42	8.85	NRSM7010NB15	2P	150	23	-	50	7	5.5	8	1(6)	028	○

Intro

SP

SL

PO

ST

ROLL

CARBIDE

LONG

JIS

HAND
TAPS

EG (STI)

SPECIAL
THREADS,
GAUGESTHREAD
MILLS

DIES

CENTER
DRILLSTechnical
info

HAND TAPS

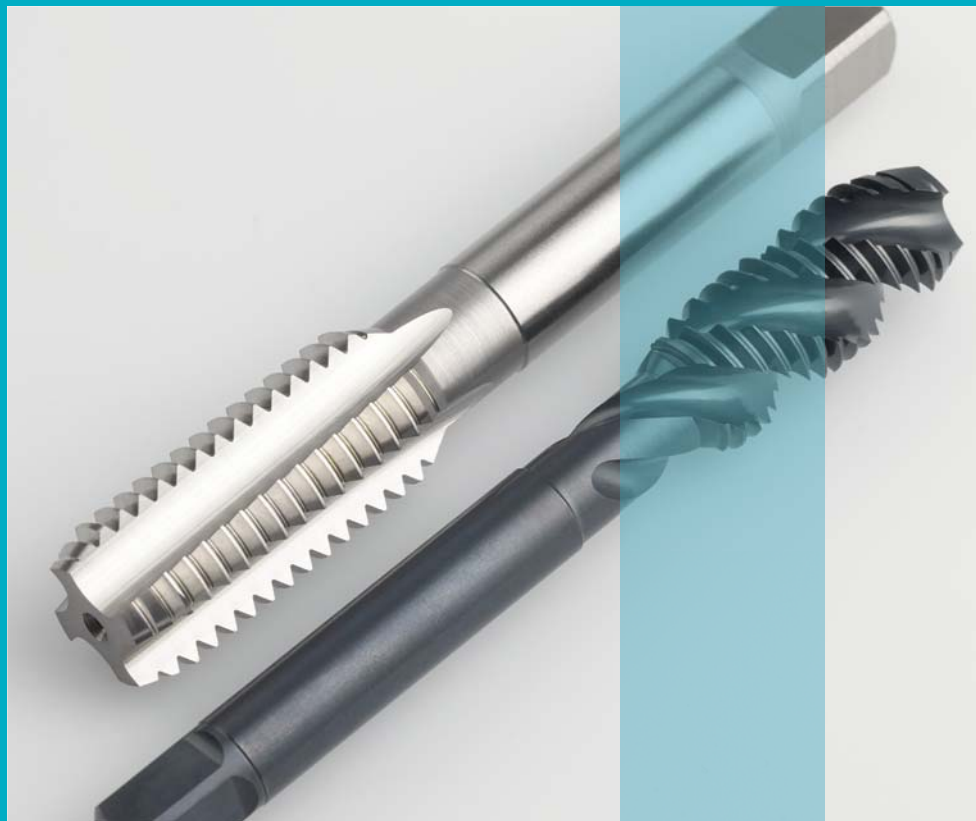

HT - DIN **498**
HT - JIS **504**

Selection Chart

Intro

SP

SL

PO

ST

ROLL

CARBIDE

LONG

HAND TAPS

EG (STI)

SPECIAL THREADS, GAUGES

THREAD MILLS

DIES

CENTER DRILLS

Technical info

		HT Hand taps						
		6110	HT DIN352	6412	HT DIN5157	ISP	IPO	IHT
		HSS-E	HSS-E	HSS-E	HSS-E	HSS-E OX	HSS-E OX	HSS-E OX
		DIN						
		DIN	DIN	DIN	DIN	JIS	JIS	JIS
M		499	501			504	505	506
MF								
UNC/UNF								
UNS, 8, 12, 20, 32UN								
UNEF								
G (BSP)				502	503			
Rp (BSPP)								
Rc (BSPT)								
NPT								
NPTF								
NPSC, NPSM, NPSF								
BSW								
EG(STI), M, MF, UNC/UNF								
Pg								
Tr								
S miniature								
Special threads								
		Vc (m/min)						
P1		★	★ <5	★	★ <5	★ ≤5	★ ≤5	★ ≤5
P2		★	★ <5	★	★ <5	☆ ≤5	☆ ≤5	☆ ≤5
P3		★	★ <5	★	★ <5			
P4		☆	☆ <5	☆	☆ <5			
P5								
P6								
P7								
P8								
M1								
M2								
M3								
K1		☆	☆ <5	☆	☆ <5			
K2		☆	☆ <5	☆	☆ <5			
K3			☆ <5		☆ <5			
K4								
N1		☆	☆ <5	☆	☆ <5			
N2		☆	☆ <5	☆	☆ <5			
N3		☆	☆ <5	☆	☆ <5			
N4		☆	☆ <5	☆	☆ <5			
N5								
S1 (<25 HRC)								
S2 (<35 HRC)								
S3 (35 ÷ 45 HRC)								
S5								
H (45 ÷ 55 HRC)								
H (55 ÷ 63 HRC)								

★ 1st choice ☆ suitable

Intro

SP

SL

PO

ST

ROLL

CARBIDE

LONG

**HAND
TAPS**

EG (STI)

SPECIAL
THREADS,
GAUGES

THREAD
MILLS

DIES

CENTER
DRILLS

Technical
info

Intro

6110

HT Hand taps

Serial taps for manual use

SP

SL



PO

RECOMMENDED TAPPING SPEEDS DEPENDING ON MATERIALS

ISO	Vc (m/min)	ISO	Vc (m/min)	ISO	Vc (m/min)
P1	★	K1	☆	N1	☆
P2	★	K2	☆	N2	☆
P3	★			N3	☆
P4	☆			N4	☆

★ 1st choice ☆ suitable

ST

ROLL

CARBIDE

LONG

HAND TAPS
DIN

EG (STI)

SPECIAL
THREADS,
GAUGES

THREAD
MILLS

DIES

CENTER
DRILLS

Technical
info



FEATURES

Hand set V+M+F profile.

V and M taps produce partial thread crests profile, F tap produces full thread crests profile.

TYPE: EU_118

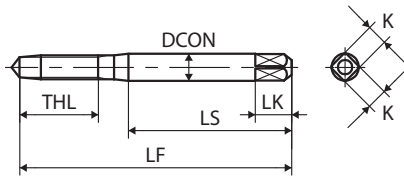

TYPE: EU_119

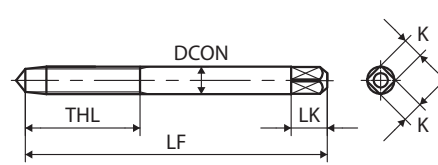

TYPE: EU_120

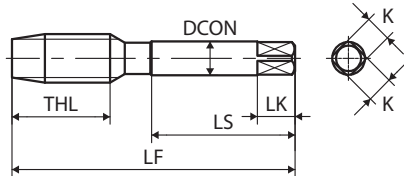

M	TCTR (tolerance)	 Hole Ø (mm)	Hole Ø (mm)	Code	THCHT (chamfer)	LF (mm)	THL (mm)	LU (mm)	LS (mm)	DCON (mm)	K (mm)	LK (mm)	NOF	Type	Stock
DIN 352															
M2X0.4	ISO2(6H)	1.6	1.65	61102.0S	V+M+F	36	8	-	21	2.8	2.1	5	3	118	●
M2.5X0.45	ISO2(6H)	2.1	2.11	61102.5S	V+M+F	40	9	-	27	2.8	2.1	5	3	118	●
M3X0.5	ISO2(6H)	2.5	2.56	61103.0S	V+M+F	40	11	-	24	3.5	2.7	6	3	118	●
M4X0.7	ISO2(6H)	3.3	3.38	61104.0S	V+M+F	45	13	-	27	4.5	3.4	6	3	118	●
M5X0.8	ISO2(6H)	4.2	4.28	61105.0S	V+M+F	50	16	-	24	6	4.9	8	3	118	●
M6X1	ISO2(6H)	5	5.09	61106.0S	V+M+F	50	19	-	-	6	4.9	8	3	119	●
M8X1.25	ISO2(6H)	6.8	6.85	61108.0S	V+M+F	56	19	-	29	6	4.9	8	4	120	●
M10X1.5	ISO2(6H)	8.5	8.6	6110010S	V+M+F	70	23	-	36	7	5.5	8	4	120	●
M12X1.75	ISO2(6H)	10.3	10.36	6110012S	V+M+F	75	26	-	38	9	7	10	4	120	●
M14X2	ISO2(6H)	12	12.12	6110014S	V+M+F	80	26	-	41	11	9	12	4	120	●
M16X2	ISO2(6H)	14	14.12	6110016S	V+M+F	80	26	-	41	12	9	12	4	120	●
M18X2.5	ISO2(6H)	15.5	15.63	6110018S	V+M+F	95	33	-	48	14	11	14	4	120	●
M20X2.5	ISO2(6H)	17.5	17.63	6110020S	V+M+F	95	33	-	48	16	12	15	4	120	●
M24X3	ISO2(6H)	21	21.13	6110024S	V+M+F	110	39	-	56	18	14.5	17	4	120	●

Intro

SP

SL

PO

ST

ROLL

CARBIDE

LONG

HAND
TAPS
DIN

EG (STI)

SPECIAL
THREADS,
GAUGESTHREAD
MILLS

DIES

CENTER
DRILLSTechnical
info

Intro

HT DIN352

HT Hand taps

SP

Straight Fluted Taps for manual and drilling machine use

SL



PO

Recommended Tapping Speeds Depending On Materials

ISO	Vc (m/min)	★	ISO	Vc (m/min)	☆	ISO	Vc (m/min)	☆
P1	<5	★	K1	<5	☆	N1	<5	☆
P2	<5	★	K2	<5	☆	N2	<5	☆
P3	<5	★	K3	<5	☆	N3	<5	☆
P4	<5	☆				N4	<5	☆

★ 1st choice ☆ suitable

ROLL

CARBIDE

LONG

**HAND TAPS
DIN**

EG (STI)

SPECIAL
THREADS,
GAUGES

THREAD
MILLS

DIES

CENTER
DRILLS

Technical
info



FEATURES

Straight fluted taps with V, M, F profile for hand set assembling.

V and M taps produce partial thread crests profile, F tap produces full thread crests profile.

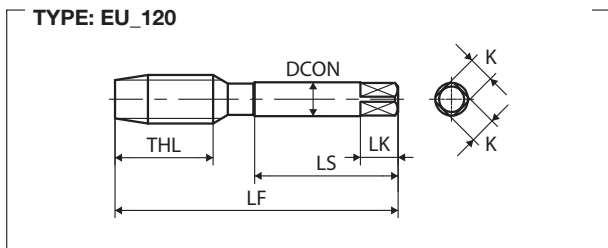
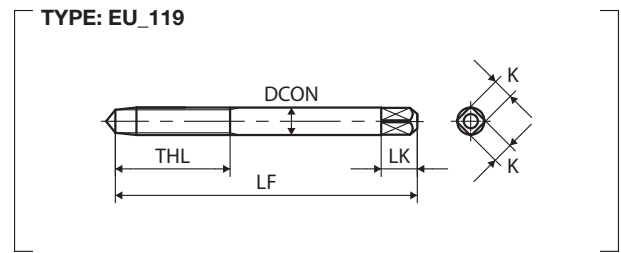
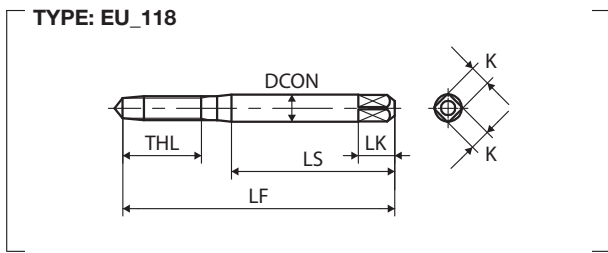

M	TCTR (tolerance)	 Hole Ø (mm)	Hole Ø (mm)	Code	THCHT (chamfer)	LF (mm)	THL (mm)	LU (mm)	LS (mm)	DCON (mm)	K (mm)	LK (mm)	NOF	Type	Stock
DIN 352															
M2X0.4	ISO2(6H)	1.6	1.65	TQ2.0EANE B2	F	36	8	-	21	2.8	2.1	5	3	118	○
	ISO2(6H)	1.6	1.65	TQ2.0EANE BU	M	36	8	-	21	2.8	2.1	5	3	118	○
	ISO2(6H)	1.6	1.65	TQ2.0EANE B5	V	36	8	-	21	2.8	2.1	5	3	118	○
M2.5X0.45	ISO2(6H)	2.1	2.11	TQ2.5FANE B2	F	40	9	-	27	2.8	2.1	5	3	118	○
	ISO2(6H)	2.1	2.11	TQ2.5FANE BU	M	40	9	-	27	2.8	2.1	5	3	118	○
	ISO2(6H)	2.1	2.11	TQ2.5FANE B5	V	40	9	-	27	2.8	2.1	5	3	118	○
M3X0.5	ISO2(6H)	2.5	2.56	TQ3.0GANE B2	F	40	11	-	24	3.5	2.7	6	3	118	●
	ISO2(6H)	2.5	2.56	TQ3.0GANE BU	M	40	11	-	24	3.5	2.7	6	3	118	○
	ISO2(6H)	2.5	2.56	TQ3.0GANE B5	V	40	11	-	24	3.5	2.7	6	3	118	○
M4X0.7	ISO2(6H)	3.3	3.38	TQ4.0IANE B2	F	45	13	-	27	4.5	3.4	6	3	118	●
	ISO2(6H)	3.3	3.38	TQ4.0IANE BU	M	45	13	-	27	4.5	3.4	6	3	118	○
	ISO2(6H)	3.3	3.38	TQ4.0IANE B5	V	45	13	-	27	4.5	3.4	6	3	118	○
M5X0.8	ISO2(6H)	4.2	4.28	TQ5.0KANE B2	F	50	16	-	24	6	4.9	8	3	118	●
	ISO2(6H)	4.2	4.28	TQ5.0KANE BU	M	50	16	-	24	6	4.9	8	3	118	○
	ISO2(6H)	4.2	4.28	TQ5.0KANE B5	V	50	16	-	24	6	4.9	8	3	118	○
M6X1	ISO2(6H)	5	5.09	TQ6.0MANE B2	F	50	19	-	-	6	4.9	8	3	119	●
	ISO2(6H)	5	5.09	TQ6.0MANE BU	M	50	19	-	-	6	4.9	8	3	119	○
	ISO2(6H)	5	5.09	TQ6.0MANE B5	V	50	19	-	-	6	4.9	8	3	119	○
M8X1.25	ISO2(6H)	6.8	6.85	TQ8.0NANE B2	F	56	19	-	29	6	4.9	8	4	120	●
	ISO2(6H)	6.8	6.85	TQ8.0NANE BU	M	56	19	-	29	6	4.9	8	4	120	○
	ISO2(6H)	6.8	6.85	TQ8.0NANE B5	V	56	19	-	29	6	4.9	8	4	120	○
M10X1.5	ISO2(6H)	8.5	8.6	TQ0100ANE B2	F	70	23	-	36	7	5.5	8	4	120	●
	ISO2(6H)	8.5	8.6	TQ0100ANE BU	M	70	23	-	36	7	5.5	8	4	120	○
	ISO2(6H)	8.5	8.6	TQ0100ANE B5	V	70	23	-	36	7	5.5	8	4	120	○
M12X1.75	ISO2(6H)	10.3	10.36	TQ012PANE B2	F	75	26	-	38	9	7	10	4	120	●
	ISO2(6H)	10.3	10.36	TQ012PANE BU	M	75	26	-	38	9	7	10	4	120	○
	ISO2(6H)	10.3	10.36	TQ012PANE B5	V	75	26	-	38	9	7	10	4	120	○
M14X2	ISO2(6H)	12	12.12	TQ014QANE B2	F	80	26	-	41	11	9	12	4	120	○
	ISO2(6H)	12	12.12	TQ014QANE BU	M	80	26	-	41	11	9	12	4	120	○
	ISO2(6H)	12	12.12	TQ014QANE B5	V	80	26	-	41	11	9	12	4	120	○
M16X2	ISO2(6H)	14	14.12	TQ016QANE B2	F	80	26	-	41	12	9	12	4	120	○
	ISO2(6H)	14	14.12	TQ016QANE BU	M	80	26	-	41	12	9	12	4	120	○
	ISO2(6H)	14	14.12	TQ016QANE B5	V	80	26	-	41	12	9	12	4	120	○
M18X2.5	ISO2(6H)	15.5	15.63	TQ018RANE B2	F	95	33	-	48	14	11	14	4	120	○
	ISO2(6H)	15.5	15.63	TQ018RANE BU	M	95	33	-	48	14	11	14	4	120	○
	ISO2(6H)	15.5	15.63	TQ018RANE B5	V	95	33	-	48	14	11	14	4	120	○
M20X2.5	ISO2(6H)	17.5	17.63	TQ020RANE B2	F	95	33	-	48	16	12	15	4	120	○
	ISO2(6H)	17.5	17.63	TQ020RANE BU	M	95	33	-	48	16	12	15	4	120	○
	ISO2(6H)	17.5	17.63	TQ020RANE B5	V	95	33	-	48	16	12	15	4	120	○
M24X3	ISO2(6H)	21	21.13	TQ024SANE B2	F	110	39	-	56	18	14.5	17	4	120	○
	ISO2(6H)	21	21.13	TQ024SANE BU	M	110	39	-	56	18	14.5	17	4	120	○
	ISO2(6H)	21	21.13	TQ024SANE B5	V	110	39	-	56	18	14.5	17	4	120	○

Intro

SP

SL

PO

ST

ROLL

CARBIDE

LONG

HAND TAPS
DIN

EG (STI)

SPECIAL THREADS, GAUGES

THREAD MILLS

DIES

CENTER DRILLS

Technical info

Intro

6412

HT Hand taps

SP

Serial taps for manual use

SL

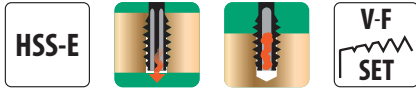

PO

RECOMMENDED TAPPING SPEEDS DEPENDING ON MATERIALS

ISO	Vc (m/min)	ISO	Vc (m/min)	ISO	Vc (m/min)
P1	★	K1	☆	N1	☆
P2	★	K2	☆	N2	☆
P3	★			N3	☆
P4	☆			N4	☆

★ 1st choice ☆ suitable

FEATURES

Hand set V+F profile.

V tap produces partial thread crests profile, F tap produces full thread crests profile.

ROLL

CARBIDE

LONG

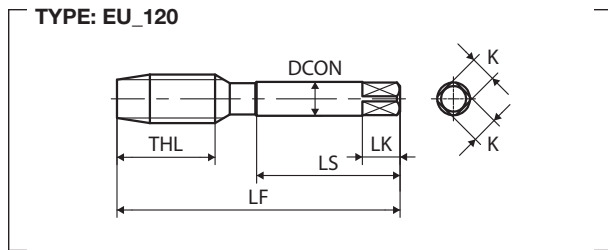

HAND TAPS

DIN

G(BSP)	TCTR (tolerance)	Ø (mm)	Hole Ø (mm)	Code	THCHT (chamfer)	Basic major Ø (mm)	LF (mm)	THL (mm)	LS (mm)	DCON (mm)	K (mm)	LK (mm)	NOF	Type	Stock
DIN 5157															
1/8-28	-	8.75	8.78	6412G02S	V+F	9.728	63	19	32	7	5.5	8	4	120	●
1/4-19	-	11.75	11.78	6412G04S	V+F	13.157	70	21	36	11	9	12	4	120	●
3/8-19	-	15.25	15.28	6412G06S	V+F	16.662	70	21	36	12	9	12	4	120	●
1/2-14	-	19	19.04	6412G08S	V+F	20.955	80	21	41	16	12	15	4	120	●
3/4-14	-	24.5	24.52	6412G12S	V+F	26.441	90	21	46	20	16	19	4	120	●
1-11	-	30.75	30.77	6412G16S	V+F	33.249	100	24	51	25	20	23	4	120	●

THREAD MILLS

DIES

CENTER DRILLS

Technical info

HT DIN5157

HT Hand taps

Straight Fluted Taps for manual and drilling machine use



FEATURES

Straight fluted taps with V, F profile for hand set assembling.

V tap produces partial thread crests profile, F tap produces full thread crests profile.

Recommended Tapping Speeds Depending On Materials

ISO	Vc (m/min)	★	ISO	Vc (m/min)	☆	ISO	Vc (m/min)	☆
P1	<5	★	K1	<5	☆	N1	<5	☆
P2	<5	★	K2	<5	☆	N2	<5	☆
P3	<5	★	K3	<5	☆	N3	<5	☆
P4	<5	☆				N4	<5	☆

★ 1st choice ☆ suitable

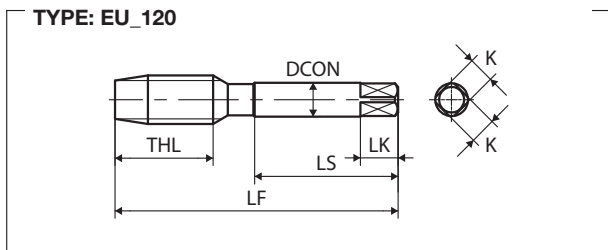

G(BSP)	TCTR (tolerance)	∅ (mm)	Hole ∅ (mm)	Code	THCHT (chamfer)	Basic major ∅ (mm)	LF (mm)	THL (mm)	LS (mm)	DCON (mm)	K (mm)	LK (mm)	NOF	Type	Stock
DIN 5157															
1/8-28	-	8.75	8.78	T9G0020NEB2	F	9.728	63	19	32	7	5.5	8	4	120	○
	-	8.75	8.78	T9G0020NEB5	V	9.728	63	19	32	7	5.5	8	4	120	○
1/4-19	-	11.75	11.78	T9G0040NEB2	F	13.157	70	21	36	11	9	12	4	120	○
	-	11.75	11.78	T9G0040NEB5	V	13.157	70	21	36	11	9	12	4	120	○
3/8-19	-	15.25	15.28	T9G0060NEB2	F	16.662	70	21	36	12	9	12	4	120	○
	-	15.25	15.28	T9G0060NEB5	V	16.662	70	21	36	12	9	12	4	120	○
1/2-14	-	19	19.04	T9G0080NEB2	F	20.955	80	21	41	16	12	15	4	120	○
	-	19	19.04	T9G0080NEB5	V	20.955	80	21	41	16	12	15	4	120	○
3/4-14	-	24.5	24.52	T9G0120NEB2	F	26.441	90	21	46	20	16	19	4	120	○
	-	24.5	24.52	T9G0120NEB5	V	26.441	90	21	46	20	16	19	4	120	○
1-11	-	30.75	30.77	T9G0160NEB2	F	33.249	100	24	51	25	20	23	4	120	○
	-	30.75	30.77	T9G0160NEB5	V	33.249	100	24	51	25	20	23	4	120	○

Intro

SP

SL

PO

ST

ROLL

CARBIDE

LONG

HAND TAPS
DIN

EG (STI)

SPECIAL THREADS, GAUGES

THREAD MILLS

DIES

CENTER DRILLS

Technical info

Intro

ISP

HT Hand taps

SP

Spiral Fluted Taps for manual and drilling machine use

SL



PO

Recommended Tapping Speeds Depending On Materials

ISO	Vc (m/min)
P1	≤5 ★
P2	≤5 ☆

ST

★ 1st choice ☆ suitable

ROLL

CARBIDE

LONG

HAND TAPS

JIS

EG (STI)

SPECIAL THREADS, GAUGES

THREAD MILLS

DIES

CENTER DRILLS

Technical info



FEATURES

Designed for safe and stable tapping in case of manual and drilling machine application.

For blind hole application on low carbon steel.

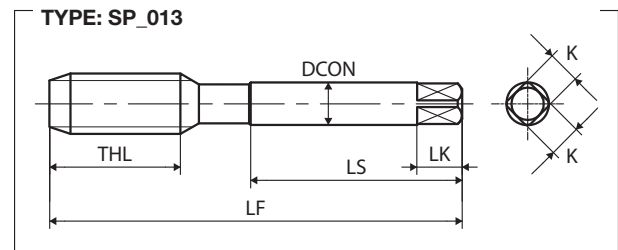
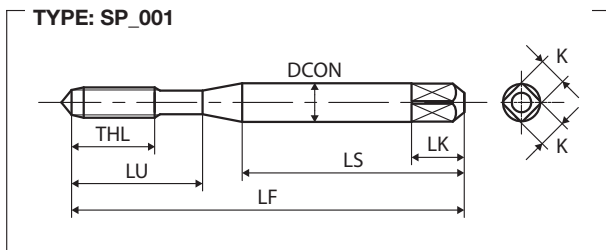

M	TCTR (tolerance)	(mm)	Hole Ø (mm)	Code	THCHT (chamfer)	LF (mm)	THL (mm)	LU (mm)	LS (mm)	DCON (mm)	K (mm)	LK (mm)	NOF	Type	Stock
JIS															
M3X0.5	-	2.5	2.56	SI73.0G	2.5P	46	9	14	26	4	3.2	6	3	001	●
M4X0.7	-	3.3	3.38	SI74.0I	2.5P	52	11	17	29	5	4	7	3	001	●
M5X0.8	-	4.2	4.28	SI75.0K	2.5P	60	13	22	33	5.5	4.5	7	3	001	●
M6X1	-	5	5.09	SI76.0M	2.5P	62	15	26	33	6	4.5	7	3	001	●
M8X1.25	-	6.8	6.85	SI78.0N	2.5P	70	19	-	36	6.2	5	8	3	013	●
M10X1.5	-	8.5	8.6	SI70100	2.5P	75	23	-	38	7	5.5	8	3	013	●

IPO

HT Hand taps

Spiral Pointed Taps for manual drilling machine use



FEATURES

Designed for safe and stable tapping in case of manual and drilling machine application.

For through hole application on low carbon steel.

Recommended Tapping Speeds Depending On Materials

ISO Vc (m/min)

P1	≤5	★
P2	≤5	☆

★ 1st choice ☆ suitable

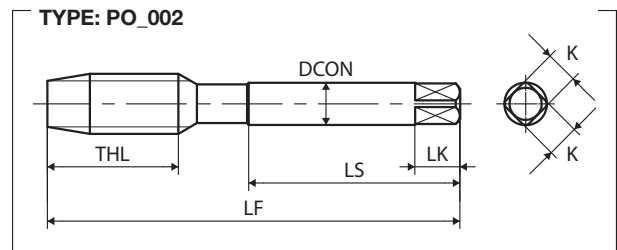
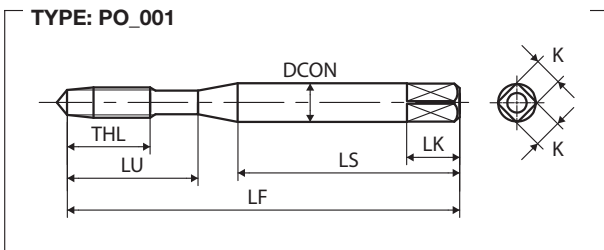

M	TCTR (tolerance)	Hole Ø (mm)	Hole Ø (mm)	Code	THCHT (chamfer)	LF (mm)	THL (mm)	LU (mm)	LS (mm)	DCON (mm)	K (mm)	LK (mm)	NOF	Type	Stock
JIS															
M3X0.5	-	2.5	2.56	PI73.0G	5P	46	9	14	26	4	3.2	6	3	001	●
M4X0.7	-	3.3	3.38	PI74.0I	5P	52	11	17	29	5	4	7	3	001	●
M5X0.8	-	4.2	4.28	PI75.0K	5P	60	13	22	33	5.5	4.5	7	3	001	●
M6X1	-	5	5.09	PI76.0M	5P	62	15	26	33	6	4.5	7	3	001	●
M8X1.25	-	6.8	6.85	PI78.0N	5P	70	19	-	36	6.2	5	8	3	002	●
M10X1.5	-	8.5	8.6	PI70100	5P	75	23	-	38	7	5.5	8	3	002	●

Intro

SP

SL

PO

ST

ROLL

CARBIDE

LONG

HAND TAPS
JIS

EG (STI)

SPECIAL
THREADS,
GAUGES

THREAD
MILLS

DIES

CENTER
DRILLS

Technical
info

Intro

IHT

HT Hand taps

SP

Straight Fluted Taps for manual and drilling machine use

SL



PO

Recommended Tapping Speeds Depending On Materials

ISO Vc (m/min)

P1 ≤5 ★

P2 ≤5 ☆

ST

★ 1st choice ☆ suitable

ROLL

CARBIDE

LONG

HAND TAPS

JIS

EG (STI)

SPECIAL THREADS, GAUGES

THREAD MILLS

DIES

CENTER DRILLS

Technical info



FEATURES

Designed for safe and stable tapping in case of manual and drilling machine application.

For blind (2P) and through (5P) hole application on low carbon steel.

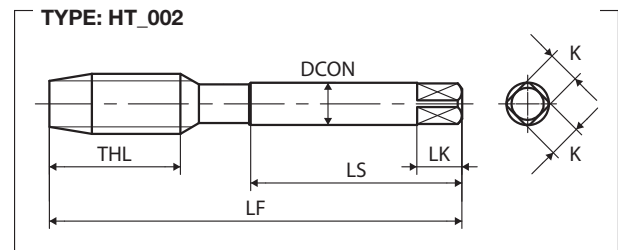
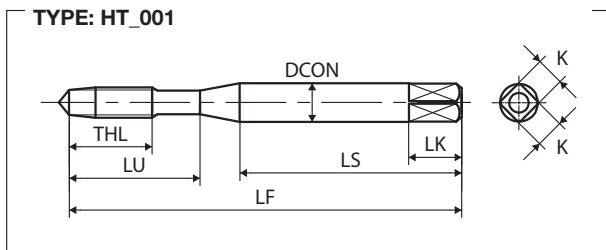

M	TCTR (tolerance)	Hole Ø (mm)	Hole Ø (mm)	Code	THCHT (chamfer)	LF (mm)	THL (mm)	LU (mm)	LS (mm)	DCON (mm)	K (mm)	LK (mm)	NOF	Type	Stock
JIS															
M3X0.5	-	2.5	2.56	HI73.0G5	5P	46	9	14	26	4	3.2	6	3	001	●
	-	2.5	2.56	HI73.0G2	2P	46	9	14	26	4	3.2	6	3	001	●
M4X0.7	-	3.3	3.38	HI74.0I5	5P	52	11	17	29	5	4	7	3	001	●
	-	3.3	3.38	HI74.0I2	2P	52	11	17	29	5	4	7	3	001	●
M5X0.8	-	4.2	4.28	HI75.0K5	5P	60	13	22	33	5.5	4.5	7	3	001	●
	-	4.2	4.28	HI75.0K2	2P	60	13	22	33	5.5	4.5	7	3	001	●
M6X1	-	5	5.09	HI76.0M5	5P	62	15	26	33	6	4.5	7	3	001	●
	-	5	5.09	HI76.0M2	2P	62	15	26	33	6	4.5	7	3	001	●
M8X1.25	-	6.8	6.85	HI78.0N5	5P	70	19	-	36	6.2	5	8	3	002	●
	-	6.8	6.85	HI78.0N2	2P	70	19	-	36	6.2	5	8	3	002	●
M10X1.5	-	8.5	8.6	HI701005	5P	75	23	-	38	7	5.5	8	3	002	●
	-	8.5	8.6	HI701002	2P	75	23	-	38	7	5.5	8	3	002	●

● stock standard, ○ non-standard stock, ▽ stock exhaustion

EG STI TAPS



EG (STI) - JIS **510**
EG (STI) - ANSI **520**

Selection Chart

Intro

SP

SL

PO

ST

ROLL

CARBIDE

LONG

HAND TAPS

EG (STI)

SPECIAL THREADS, GAUGES

THREAD MILLS

DIES

CENTER DRILLS

Technical info

	GP General Purpose				MS Material Specific			
	SP STI	PO STI	HT STI	N-RS STI	AL-SP STI	AL-PO STI	AL-HT STI	ZELX NI SP STI
	HSS-E NI	HSS-E	HSS-E	HSS-E NI	HSS-E NI	HSS-E	HSS-E	HSS-P NX
	ANSI	ANSI	ANSI	JIS	JIS	JIS	JIS	ANSI
M								
MF								
UNC/UNF								
UNS, 8, 12, 20, 32UN								
UNEF								
G (BSP)								
Rp (BSPP)								
Rc (BSPT)								
NPT								
NPTF								
NPSC, NPSM, NPSF								
BSW								
EG(STI), M, MF, UNC/UNF	521	525	529	519	511	513	515	522
Pg								
Tr								
S miniature								
Special threads								
	Vc (m/min)							
P1	☆ 5÷10	☆ 5÷10	☆ 5÷10					☆ 5÷15
P2	☆ 5÷10	☆ 5÷10	☆ 5÷10					☆ 5÷15
P3	☆ 5÷10	☆ 5÷10	☆ 5÷10					★ 5÷15
P4								★ 5÷15
P5								☆ 5÷10
P6								
P7								★ 5÷15
P8								★ 4÷8
M1								★ 5÷15
M2								★ 5÷15
M3								★ 4÷8
K1								
K2								
K3								
K4								
N1	★ 5÷15	★ 5÷15	★ 5÷15	★ 5÷15	★ 10÷25	★ 5÷15	★ 5÷15	
N2	★ 5÷15	★ 5÷15	★ 5÷15	★ 5÷15	★ 10÷25	★ 5÷15	★ 5÷15	
N3	★ 5÷15	★ 5÷15	★ 5÷10	★ 5÷15	★ 10÷25	★ 5÷15	☆ 5÷10	
N4	★ 5÷15	★ 5÷15	★ 5÷10		★ 10÷25	★ 5÷15	★ 5÷10	
N5								
S1 (<25 HRC)								★ 5÷10
S2 (<35 HRC)								★ 5÷10
S3 (35 ÷ 45 HRC)								
S5								
H (45 ÷ 55 HRC)								
H (55 ÷ 63 HRC)								

★ 1st choice ☆ suitable

MS Material Specific

ZELX NI PO STI

HSS-P

NX



ANSI

	M
	MF
	UNC/UNF
	UNS, 8, 12, 20, 32UN
	UNEF
	G (BSP)
	Rp (BSPP)
	Rc (BSPT)
	NPT
	NPTF
	NPSC, NPSM, NPSF
	BSW
527	EG(STI), M, MF, UNC/UNF
	Pg
	Tr
	S miniature
	Special threads

Vc (m/min)		
		P1
		P2
★	5÷15	P3
★	5÷15	P4
☆	5÷10	P5
		P6
★	5÷15	P7
★	4÷8	P8
★	5÷15	M1
★	5÷15	M2
★	4÷8	M3
		K1
		K2
		K3
		K4
		N1
		N2
		N3
		N4
		N5
★	5÷10	S1 (<25 HRC)
★	5÷10	S2 (<35 HRC)
☆	3÷6	S3 (35 ÷ 45 HRC)
		S5
		H (45 ÷ 55 HRC)
		H (55 ÷ 63 HRC)

Intro

SP

SL

PO

ST

ROLL

CARBIDE

LONG

HAND TAPS

EG (STI)

SPECIAL THREADS, GAUGES

THREAD MILLS

DIES

CENTER DRILLS

Technical info

Intro

AL-SP STI



MS Material Specific Series

SP Spiral Fluted Taps for Helical Coil Wire Screw Thread Inserts on Aluminium Alloys

SL



PO

Recommended Tapping Speeds Depending On Materials

ISO	Vc (m/min)
N1	10÷25 ★
N2	10÷25 ★
N3	10÷25 ★
N4	10÷25 ★

★ 1st choice ☆ suitable

ST

ROLL

CARBIDE

LONG

HAND TAPS

EG (STI)

JIS

SPECIAL THREADS, GAUGES

THREAD MILLS

DIES



CENTER DRILLS

Technical info

FEATURES

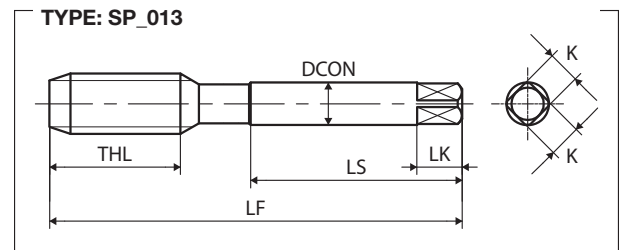
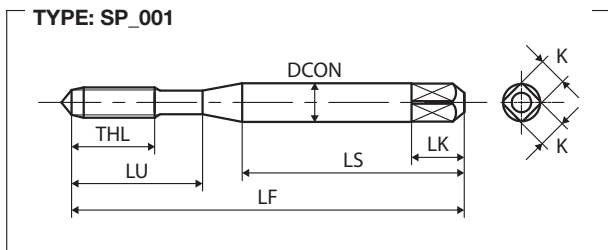
Material specific for blind hole application. Specific design and NI treatment allow stable and long life on Aluminium, Aluminium casting and die-casting.



EG(STI) M	TCTR (tolerance)	 Hole Ø (mm)	Hole Ø (mm)	Code	THCHT (chamfer)	LF (mm)	THL (mm)	LU (mm)	LS (mm)	DCON (mm)	K (mm)	LK (mm)	NOF	Type	Stock
JIS															
STI M3X0.5	1b	3.15	3.18	SW3.0G1LEN	2.5P	52	7.5	17	29	5	4	7	3	001	●
	1b+30	3.15	3.18	SW3.0G3LEN	2.5P	52	7.5	17	29	5	4	7	3	001	○
STI M4X0.7	1b	4.2	4.27	SW4.0I1LEN	2.5P	60	13	22	33	5.5	4.5	7	3	001	●
	1b+30	4.2	4.27	SW4.0I3LEN	2.5P	60	13	22	33	5.5	4.5	7	3	001	○
STI M5X0.8	1b	5.2	5.29	SW5.0K1LEN	2.5P	62	15	26	33	6	4.5	7	3	001	●
	1b+30	5.2	5.29	SW5.0K3LEN	2.5P	62	15	26	33	6	4.5	7	3	001	○
STI M6X1	1b	6.3	6.38	SW6.0M1LEN	2.5P	70	19	-	36	6.2	5	8	3	013	●
	1b+30	6.3	6.38	SW6.0M3LEN	2.5P	70	19	-	36	6.2	5	8	3	013	○
STI M8X1.25	1b	8.4	8.47	SW8.0N1LEN	2.5P	75	23	-	38	7	5.5	8	3	013	●
	1b+30	8.4	8.47	SW8.0N3LEN	2.5P	75	23	-	38	7	5.5	8	3	013	○
STI M10X1.5	1b	10.5	10.56	SW01001LEN	2.5P	82	26	-	42	8.5	6.5	9	3	013	●
	1b+30	10.5	10.56	SW01003LEN	2.5P	82	26	-	42	8.5	6.5	9	3	013	○
STI M12X1.75	1b	12.6	12.66	SW012P1LEN	2.5P	95	26	-	48	12.5	10	13	3	013	●
STI M14X2	1b	14.7	14.75	SW014Q1LEN	2.5P	100	33	-	51	14	11	14	3	013	○
STI M16X2	1b	16.7	16.75	SW016Q1LEN	2.5P	105	33	-	50	15	12	15	4	013	●
STI M18X2.5	1b	18.9	18.93	SW018R1LEN	2.5P	115	33	-	55	17	13	16	4	013	○
STI M20X2.5	1b	20.9	20.93	SW020R1LEN	2.5P	120	39	-	55	19	15	18	4	013	○
STI M22X2.5	1b	22.9	22.93	SW022R1LEN	2.5P	125	39	-	58	19	15	18	4	013	○
STI M24X3	1b	25.1	25.11	SW024S1LEN	2.5P	135	46	-	62	23	17	20	4	013	○
CARBIDE															
EG(STI) MF	TCTR (tolerance)	 Hole Ø (mm)	Hole Ø (mm)	Code	THCHT (chamfer)	LF (mm)	THL (mm)	LU (mm)	LS (mm)	DCON (mm)	K (mm)	LK (mm)	NOF	Type	Stock
JIS															
STI M10X1.25	1b	10.4	10.47	SW010N1LEN	2.5P	82	26	-	42	8.5	6.5	9	3	013	○
STI M12X1.25	1b	12.4	12.47	SW012N1LEN	2.5P	88	26	-	45	10.5	8	11	3	013	○
STI M12X1.5	1b	12.5	12.56	SW012O1LEN	2.5P	88	26	-	45	10.5	8	11	3	013	○
STI M14X1.5	1b	14.5	14.56	SW014O1LEN	2.5P	95	26	-	48	12.5	10	13	3	013	○
STI M16X1.5	1b	16.5	16.56	SW016O1LEN	2.5P	100	33	-	51	14	11	14	4	013	○
STI M18X1.5	1b	18.5	18.56	SW018O1LEN	2.5P	105	33	-	50	15	12	15	4	013	○
STI M20X1.5	1b	20.5	20.56	SW020O1LEN	2.5P	115	33	-	55	17	13	16	4	013	○

Intro

SP

SL

PO

ST

ROLL

CARBIDE

LONG

HAND
TAPS

EG (STI)

JIS

SPECIAL
THREADS,
GAUGESTHREAD
MILLS

DIES

CENTER
DRILLSTechnical
info

Intro

AL-PO STI



SP

MS Material Specific Series

Spiral Pointed Taps for Helical Coil Wire Screw Thread Inserts on Aluminium Alloys

SL



PO

Recommended Tapping Speeds Depending On Materials

ISO	Vc (m/min)
N1	5÷15 ★
N2	5÷15 ★
N3	5÷15 ★
N4	5÷15 ★

★ 1st choice ☆ suitable

ST

ROLL

CARBIDE

LONG

HAND TAPS

EG (STI)

JIS

SPECIAL THREADS, GAUGES

THREAD MILLS

DIES

CENTER DRILLS

Technical info

FEATURES

Material specific for through hole application. Specific design and NI treatment allow stable and long life on Aluminium, Aluminium casting and die-casting.

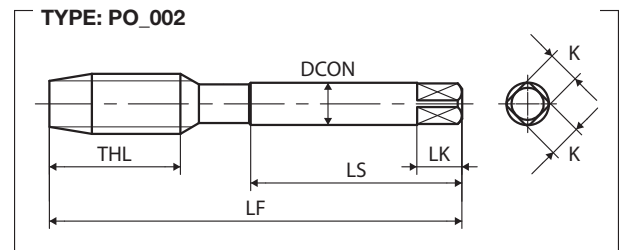
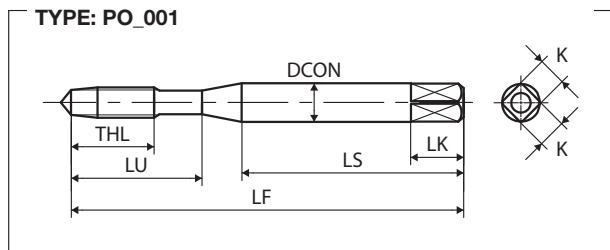

EG(STI) M	TCTR (tolerance)	 Hole Ø (mm)	Hole Ø (mm)	Code	THCHT (chamfer)	LF (mm)	THL (mm)	LU (mm)	LS (mm)	DCON (mm)	K (mm)	LK (mm)	NOF	Type	Stock
JIS															
STI M3X0.5	1b	3.15	3.18	PW3.0G1LEB	5P	52	7.5	17	29	5	4	7	3	001	○
STI M4X0.7	1b	4.2	4.27	PW4.0I1LEB	5P	60	13	22	33	5.5	4.5	7	3	001	○
STI M5X0.8	1b	5.2	5.29	PW5.0K1LEB	5P	62	15	26	33	6	4.5	7	3	001	○
STI M6X1	1b	6.3	6.38	PW6.0M1LEB	5P	70	19	-	36	6.2	5	8	3	002	○
STI M8X1.25	1b	8.4	8.47	PW8.0N1LEB	5P	75	23	-	38	7	5.5	8	3	002	○
STI M10X1.5	1b	10.5	10.56	PW01001LEB	5P	82	26	-	42	8.5	6.5	9	3	002	○
STI M12X1.75	1b	12.6	12.66	PW012P1LEB	5P	95	26	-	48	12.5	10	13	3	002	○

Intro

SP

SL

PO

ST

ROLL

CARBIDE

LONG

HAND
TAPS

EG (STI)

JIS

SPECIAL
THREADS,
GAUGESTHREAD
MILLS

DIES

CENTER
DRILLSTechnical
info

Intro

AL-HT STI

MS Material Specific Series

Straight Fluted Taps for Helical Coil Wire Screw Thread Inserts on Aluminium Alloys



SP

SL



FEATURES

Material specific for blind and through hole application. Specific design and NI treatment allow stable and long life on Aluminium, Aluminium casting and die-casting. 1.5P chamfer for blind hole application, 5P chamfer for through hole application.

PO

Recommended Tapping Speeds Depending On Materials

ISO	Vc (m/min)	
N1	5÷15	★
N2	5÷15	★
N3	5÷10	☆
N4	5÷10	★

★ 1st choice ☆ suitable

ST

ROLL

CARBIDE

LONG

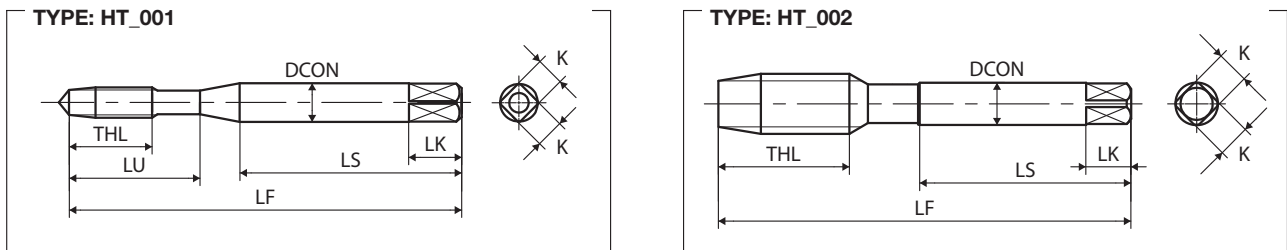

HAND TAPS

EG (STI)

JIS

SPECIAL THREADS, GAUGES

THREAD MILLS

DIES

CENTER DRILLS

Technical info

EG(STI) M	TCTR (tolerance)	\varnothing (mm)	Hole \varnothing (mm)	Code	THCHT (chamfer)	LF (mm)	THL (mm)	LU (mm)	LS (mm)	DCON (mm)	K (mm)	LK (mm)	NOF	Type	Stock	
JIS																Intro
STI M2.6X0.45	1b	2.7	2.76	TW2.6F1LEB5	5P	52	6.8	16	29	5	4	7	3	001	○	
	1b	2.7	2.76	TW2.6F1LEBA	1.5P	52	6.8	16	29	5	4	7	3	001	○	SP
STI M3X0.5	1b	3.15	3.18	TW3.0G1LEB5	5P	52	7.5	17	29	5	4	7	3	001	○	
	1b	3.15	3.18	TW3.0G1LEBA	1.5P	52	7.5	17	29	5	4	7	3	001	●	
	1b+30	3.15	3.18	TW3.0G3LEB5	5P	52	7.5	17	29	5	4	7	3	001	○	SL
	1b+30	3.15	3.18	TW3.0G3LEBA	1.5P	52	7.5	17	29	5	4	7	3	001	○	
STI M4X0.7	1b	4.2	4.27	TW4.0I1LEB5	5P	60	13	22	33	5.5	4.5	7	4	001	○	
	1b	4.2	4.27	TW4.0I1LEBA	1.5P	60	13	22	33	5.5	4.5	7	4	001	●	
	1b+30	4.2	4.27	TW4.0I3LEB5	5P	60	13	22	33	5.5	4.5	7	4	001	○	PO
	1b+30	4.2	4.27	TW4.0I3LEBA	1.5P	60	13	22	33	5.5	4.5	7	4	001	○	
STI M5X0.8	1b	5.2	5.29	TW5.0K1LEB5	5P	62	15	26	33	6	4.5	7	4	001	○	
	1b	5.2	5.29	TW5.0K1LEBA	1.5P	62	15	26	33	6	4.5	7	4	001	●	
	1b+30	5.2	5.29	TW5.0K3LEB5	5P	62	15	26	33	6	4.5	7	4	001	○	ST
	1b+30	5.2	5.29	TW5.0K3LEBA	1.5P	62	15	26	33	6	4.5	7	4	001	○	
STI M6X1	1b	6.3	6.38	TW6.0M1LEB5	5P	70	19	-	36	6.2	5	8	4	002	○	
	1b	6.3	6.38	TW6.0M1LEBA	1.5P	70	19	-	36	6.2	5	8	4	002	●	
	1b+30	6.3	6.38	TW6.0M3LEB5	5P	70	19	-	36	6.2	5	8	4	002	○	ROLL
	1b+30	6.3	6.38	TW6.0M3LEBA	1.5P	70	19	-	36	6.2	5	8	4	002	○	
STI M8X1.25	1b	8.4	8.47	TW8.0N1LEB5	5P	75	23	-	38	7	5.5	8	4	002	○	
	1b	8.4	8.47	TW8.0N1LEBA	1.5P	75	23	-	38	7	5.5	8	4	002	●	CARBIDE
	1b+30	8.4	8.47	TW8.0N3LEB5	5P	75	23	-	38	7	5.5	8	4	002	○	
	1b+30	8.4	8.47	TW8.0N3LEBA	1.5P	75	23	-	38	7	5.5	8	4	002	○	
STI M10X1.5	1b	10.5	10.56	TW01001LEB5	5P	82	26	-	42	8.5	6.5	9	4	002	○	
	1b	10.5	10.56	TW01001LEBA	1.5P	82	26	-	42	8.5	6.5	9	4	002	●	LONG
	1b+30	10.5	10.56	TW01003LEB5	5P	82	26	-	42	8.5	6.5	9	4	002	○	
	1b+30	10.5	10.56	TW01003LEBA	1.5P	82	26	-	42	8.5	6.5	9	4	002	○	
STI M12X1.75	1b	12.6	12.66	TW012P1LEB5	5P	95	26	-	48	12.5	10	13	4	002	○	
	1b	12.6	12.66	TW012P1LEBA	1.5P	95	26	-	48	12.5	10	13	4	002	●	HAND TAPS
STI M14X2	1b	14.7	14.75	TW014Q1LEB5	5P	100	33	-	51	14	11	14	4	002	○	
	1b	14.7	14.75	TW014Q1LEBA	1.5P	100	33	-	51	14	11	14	4	002	●	
STI M16X2	1b	16.7	16.75	TW016Q1LEB5	5P	105	33	-	50	15	12	15	4	002	○	
	1b	16.7	16.75	TW016Q1LEBA	1.5P	105	33	-	50	15	12	15	4	002	●	EG (STI)
STI M18X2.5	1b	18.9	18.93	TW018R1LEB5	5P	115	33	-	55	17	13	16	4	002	○	
	1b	18.9	18.93	TW018R1LEBA	1.5P	115	33	-	55	17	13	16	4	002	○	JIS
STI M20X2.5	1b	20.9	20.93	TW020R1LEB5	5P	120	39	-	55	19	15	18	4	002	○	
	1b	20.9	20.93	TW020R1LEBA	1.5P	120	39	-	55	19	15	18	4	002	●	SPECIAL THREADS, GAUGES
STI M22X2.5	1b	22.9	22.93	TW022R1LEB5	5P	125	39	-	58	19	15	18	4	002	○	
	1b	22.9	22.93	TW022R1LEBA	1.5P	125	39	-	58	19	15	18	4	002	○	THREAD MILLS
STI M24X3	1b	25.1	25.11	TW024S1LEB5	5P	135	46	-	62	23	17	20	4	002	○	
	1b	25.1	25.11	TW024S1LEBA	1.5P	135	46	-	62	23	17	20	4	002	○	
EG(STI) MF	TCTR (tolerance)	\varnothing (mm)	Hole \varnothing (mm)	Code	THCHT (chamfer)	LF (mm)	THL (mm)	LU (mm)	LS (mm)	DCON (mm)	K (mm)	LK (mm)	NOF	Type	Stock	DIES
JIS																
STI M10X1	1b	10.3	10.38	TW010M1LEB5	5P	82	26	-	42	8.5	6.5	9	4	002	○	
	1b	10.3	10.38	TW010M1LEBA	1.5P	82	26	-	42	8.5	6.5	9	4	002	○	CENTER DRILLS
STI M10X1.25	1b	10.4	10.47	TW010N1LEB5	5P	82	26	-	42	8.5	6.5	9	4	002	○	
	1b	10.4	10.47	TW010N1LEBA	1.5P	82	26	-	42	8.5	6.5	9	4	002	○	

Technical info

EG STI Taps



Intro

EG(STI) MF	TCTR (tolerance)	 Hole Ø (mm)	Hole Ø (mm)	Code	THCHT (chamfer)	LF (mm)	THL (mm)	LU (mm)	LS (mm)	DCON (mm)	K (mm)	LK (mm)	NOF	Type	Stock	
JIS																
SP	STI M12X1.25	1b	12.4	12.47	TW012N1LEB5	5P	88	26	-	45	10.5	8	11	4	002	○
		1b	12.4	12.47	TW012N1LEBA	1.5P	88	26	-	45	10.5	8	11	4	002	○
	STI M12X1.5	1b	12.5	12.56	TW01201LEB5	5P	88	26	-	45	10.5	8	11	4	002	○
		1b	12.5	12.56	TW01201LEBA	1.5P	88	26	-	45	10.5	8	11	4	002	○
SL	STI M14X1.25	1b	14.4	14.47	TW014N1LEB5	5P	95	26	-	48	12.5	10	13	4	002	○
		1b	14.4	14.47	TW014N1LEBA	1.5P	95	26	-	48	12.5	10	13	4	002	○
	STI M14X1.5	1b	14.5	14.56	TW01401LEB5	5P	95	26	-	48	12.5	10	13	4	002	○
		1b	14.5	14.56	TW01401LEBA	1.5P	95	26	-	48	12.5	10	13	4	002	○
PO	STI M16X1.5	1b	16.5	16.56	TW01601LEB5	5P	100	33	-	51	14	11	14	4	002	○
		1b	16.5	16.56	TW01601LEBA	1.5P	100	33	-	51	14	11	14	4	002	○
	STI M18X1.5	1b	18.5	18.56	TW01801LEB5	5P	105	33	-	50	15	12	15	4	002	○
		1b	18.5	18.56	TW01801LEBA	1.5P	105	33	-	50	15	12	15	4	002	○
ST	STI M20X1.5	1b	20.5	20.56	TW02001LEB5	5P	115	33	-	55	17	13	16	4	002	○
		1b	20.5	20.56	TW02001LEBA	1.5P	115	33	-	55	17	13	16	4	002	○
ROLL	STI M22X1.5	1b	22.5	22.56	TW02201LEB5	5P	120	39	-	55	19	15	18	4	002	○
		1b	22.5	22.56	TW02201LEBA	1.5P	120	39	-	55	19	15	18	4	002	○
	STI M24X1.5	1b	24.5	24.56	TW02401LEB5	5P	130	39	-	60	20	15	18	4	002	○
		1b	24.5	24.56	TW02401LEBA	1.5P	130	39	-	60	20	15	18	4	002	○
	STI M24X2	1b	24.7	24.75	TW024Q1LEB5	5P	130	39	-	60	20	15	18	4	002	○

CARBIDE

EG(STI) UNC	TCTR (tolerance)	 Hole Ø (mm)	Hole Ø (mm)	Code	THCHT (chamfer)	LF (mm)	THL (mm)	LU (mm)	LS (mm)	DCON (mm)	K (mm)	LK (mm)	NOF	Type	Stock	
JIS																
LONG	STI No.4-40UNC	1b	3	3.13	TWUN4H1LEB5	5P	52	11	17	29	5	4	7	3	001	○
		1b	3	3.13	TWUN4H1LEBA	1.5P	52	11	17	29	5	4	7	3	001	●
	STI No.5-40UNC	1b	3.3	3.44	TWUN5H1LEB5	5P	52	11	17	29	5	4	7	3	001	○
		1b	3.3	3.44	TWUN5H1LEBA	1.5P	52	11	17	29	5	4	7	3	001	○
HAND TAPS	STI No.6-32UNC	1b	3.7	3.83	TWUN6J1LEB5	5P	60	13	22	33	5.5	4.5	7	3	001	○
		1b	3.7	3.83	TWUN6J1LEBA	1.5P	60	13	22	33	5.5	4.5	7	3	001	●
	STI No.8-32UNC	1b	4.4	4.48	TWUN8J1LEB5	5P	62	15	26	33	6	4.5	7	4	001	○
		1b	4.4	4.48	TWUN8J1LEBA	1.5P	62	15	26	33	6	4.5	7	4	001	●
EG (STI)	STI No.10-24UNC	1b	5.1	5.23	TWUNAM1LEB5	5P	62	15	26	33	6	4.5	7	4	001	○
JIS		1b	5.1	5.23	TWUNAM1LEBA	1.5P	62	15	26	33	6	4.5	7	4	001	●
SPECIAL THREADS, GAUGES	STI No.12-24UNC	1b	5.7	5.89	TWUNCM1LEB5	5P	70	19	-	36	6.2	5	8	4	002	○
		1b	5.7	5.89	TWUNCM1LEBA	1.5P	70	19	-	36	6.2	5	8	4	002	○
	STI 1/4-20UNC	1b	6.7	6.81	TWU04N1LEB5	5P	70	19	-	36	6.2	5	8	4	002	○
		1b	6.7	6.81	TWU04N1LEBA	1.5P	70	19	-	36	6.2	5	8	4	002	●
THREAD MILLS	STI 5/16-18UNC	1b	8.4	8.43	TWU0501LEB5	5P	75	23	-	38	7	5.5	8	4	002	○
		1b	8.4	8.43	TWU0501LEBA	1.5P	75	23	-	38	7	5.5	8	4	002	●
	STI 3/8-16UNC	1b	10	10.06	TWU06P1LEB5	5P	82	26	-	42	8.5	6.5	9	4	002	○
		1b	10	10.06	TWU06P1LEBA	1.5P	82	26	-	42	8.5	6.5	9	4	002	●
DIES	STI 7/16-14UNC	1b	11.6	11.71	TWU07Q1LEB5	5P	88	26	-	45	10.5	8	11	4	002	○
		1b	11.6	11.71	TWU07Q1LEBA	1.5P	88	26	-	45	10.5	8	11	4	002	○
	STI 1/2-13UNC	1b	13.2	13.33	TWU08R1LEB5	5P	95	26	-	48	12.5	10	13	4	002	○
		1b	13.2	13.33	TWU08R1LEBA	1.5P	95	26	-	48	12.5	10	13	4	002	●
CENTER DRILLS	STI 5/8-11UNC	1b	16.7	16.6	TWU10U1LEB5	5P	105	33	-	50	15	12	15	4	002	○
		1b	16.7	16.6	TWU10U1LEBA	1.5P	105	33	-	50	15	12	15	4	002	●

Technical info

EG(STI) UNC	TCTR (tolerance)	 Hole Ø (mm)	Hole Ø (mm)	Code	THCHT (chamfer)	LF (mm)	THL (mm)	LU (mm)	LS (mm)	DCON (mm)	K (mm)	LK (mm)	NOF	Type	Stock
JIS															
STI 3/4-10UNC	1b	19.8	19.82	TWU12V1LEB5	5P	115	33	-	55	17	13	16	4	002	○
	1b	19.8	19.82	TWU12V1LEBA	1.5P	115	33	-	55	17	13	16	4	002	○
JIS															
EG(STI) UNF	TCTR (tolerance)	 Hole Ø (mm)	Hole Ø (mm)	Code	THCHT (chamfer)	LF (mm)	THL (mm)	LU (mm)	LS (mm)	DCON (mm)	K (mm)	LK (mm)	NOF	Type	Stock
JIS															
STI No.4-48UNF	1b	3	3.08	TWUN4F1LEB5	5P	52	11	17	29	5	4	7	3	001	○
	1b	3	3.08	TWUN4F1LEBA	1.5P	52	11	17	29	5	4	7	3	001	○
STI No.6-40UNF	1b	3.7	3.77	TWUN6H1LEB5	5P	60	13	22	33	5.5	4.5	7	3	001	○
	1b	3.7	3.77	TWUN6H1LEBA	1.5P	60	13	22	33	5.5	4.5	7	3	001	○
STI No.8-36UNF	1b	4.4	4.45	TWUN8I1LEB5	5P	62	9.5	26	33	6	4.5	7	4	001	○
	1b	4.4	4.45	TWUN8I1LEBA	1.5P	62	9.5	26	33	6	4.5	7	4	001	○
STI No.10-32UNF	1b	5.1	5.14	TWUNAJ1LEB5	5P	62	15	26	33	6	4.5	7	4	001	○
	1b	5.1	5.14	TWUNAJ1LEBA	1.5P	62	15	26	33	6	4.5	7	4	001	●
STI 1/4-28UNF	1b	6.6	6.68	TWU04K1LEB5	5P	70	19	-	36	6.2	5	8	4	002	○
	1b	6.6	6.68	TWU04K1LEBA	1.5P	70	19	-	36	6.2	5	8	4	002	●
STI 5/16-24UNF	1b	8.3	8.31	TWU05M1LEB5	5P	75	23	-	38	7	5.5	8	4	002	○
	1b	8.3	8.31	TWU05M1LEBA	1.5P	75	23	-	38	7	5.5	8	4	002	●
STI 3/8-24UNF	1b	9.8	9.89	TWU06M1LEB5	5P	82	26	-	42	8.5	6.5	9	4	002	○
	1b	9.8	9.89	TWU06M1LEBA	1.5P	82	26	-	42	8.5	6.5	9	4	002	●
STI 7/16-20UNF	1b	11.5	11.53	TWU07N1LEB5	5P	88	26	-	45	10.5	8	11	4	002	○
	1b	11.5	11.53	TWU07N1LEBA	1.5P	88	26	-	45	10.5	8	11	4	002	○
STI 1/2-20UNF	1b	13.1	13.12	TWU08N1LEB5	5P	95	26	-	48	12.5	10	13	4	002	○
	1b	13.1	13.12	TWU08N1LEBA	1.5P	95	26	-	48	12.5	10	13	4	002	●
STI 5/8-18UNF	1b	16.3	16.33	TWU1001LEB5	5P	100	33	-	51	14	11	14	4	002	○
	1b	16.3	16.33	TWU1001LEBA	1.5P	100	33	-	51	14	11	14	4	002	●
STI 3/4-16UNF	1b	19.5	19.55	TWU12P1LEB5	5P	115	33	-	55	17	13	16	4	002	○
	1b	19.5	19.55	TWU12P1LEBA	1.5P	115	33	-	55	17	13	16	4	002	●

Intro

SP

SL

PO

ST

ROLL

CARBIDE

LONG

HAND
TAPS

EG (STI)

JIS

SPECIAL
THREADS,
GAUGESTHREAD
MILLS

DIES

CENTER
DRILLSTechnical
info

Intro

N-RS STI

GP General Purpose Series

Thread Forming Taps for Helical Coil Wire Screw Thread Inserts



SP

SL



PO

Recommended Tapping Speeds Depending On Materials

ISO	Vc (m/min)	
N1	5÷15	★
N2	5÷15	★
N3	5÷15	★

★ 1st choice ☆ suitable

ST

ROLL

CARBIDE

LONG

HAND TAPS

EG (STI)

JIS

SPECIAL THREADS, GAUGES

THREAD MILLS

DIES

CENTER DRILLS

Technical info

FEATURES

Forming tap for blind and through hole application.
Specific design for non-ferrous materials.
NI treatment improves tool life.

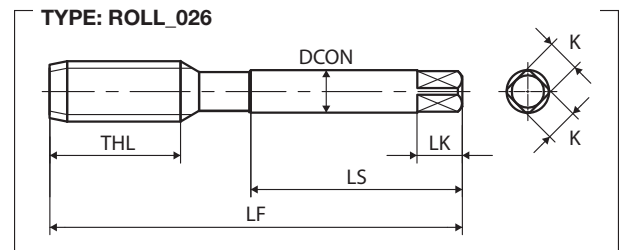
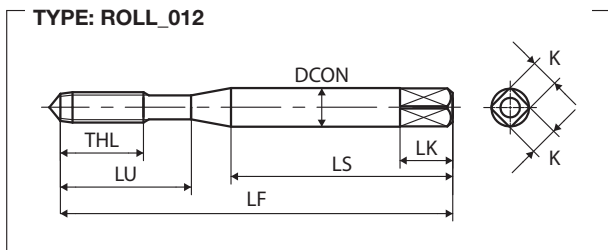

EG(STI) M	TCTR (tolerance)	Bored Hole Ø (mm)		Code	THCHT (chamfer)	LF (mm)	THL (mm)	LU (mm)	LS (mm)	DCON (mm)	K (mm)	LK (mm)	NOF (Lobes)	Type	Stock
		Max	Min												
JIS															
STI M3X0.5	G3	3.45	3.42	RW3.0G3LENP	4P	52	7.5	17	29	5	4	7	1(4)	012	○
	G3	3.45	3.42	RW3.0G3LENB	2P	52	7.5	17	29	5	4	7	1(4)	012	○
STI M4X0.7	G4	4.61	4.58	RW4.0I4LENP	4P	60	13	22	33	5.5	4.5	7	1(4)	012	○
	G4	4.61	4.58	RW4.0I4LENB	2P	60	13	22	33	5.5	4.5	7	1(4)	012	○
STI M5X0.8	G4	5.7	5.66	RW5.0K4LENP	4P	62	15	26	33	6	4.5	7	1(4)	012	○
	G4	5.7	5.66	RW5.0K4LENB	2P	62	15	26	33	6	4.5	7	1(4)	012	○
STI M6X1	G4	6.9	6.85	RW6.0M4LENP	4P	70	19	-	36	6.2	5	8	1(4)	026	○
	G4	6.9	6.85	RW6.0M4LENB	2P	70	19	-	36	6.2	5	8	1(4)	026	○
STI M8X1.25	G4	9.11	9.06	RW8.0N4LENB	2P	75	23	-	38	7	5.5	8	1(6)	026	○
	G4	9.11	9.06	RW8.0N4LENP	4P	75	23	-	38	7	5.5	8	1(6)	026	○
STI M10X1.5	G5	11.3	11.25	RW01005LENB	2P	82	26	-	42	8.5	6.5	9	1(6)	026	○
	G5	11.3	11.25	RW01005LENP	4P	82	26	-	42	8.5	6.5	9	1(6)	026	○
STI M12X1.75	G6	13.57	13.5	RW012P6LENB	2P	95	26	-	48	12.5	10	13	1(6)	026	○
	G6	13.57	13.5	RW012P6LENP	4P	95	26	-	48	12.5	10	13	1(6)	026	○
JIS															
EG(STI) MF															
EG(STI) MF	TCTR (tolerance)	Bored Hole Ø (mm)		Code	THCHT (chamfer)	LF (mm)	THL (mm)	LU (mm)	LS (mm)	DCON (mm)	K (mm)	LK (mm)	NOF (Lobes)	Type	Stock
		Max	Min												
JIS															
STI M10X1.25	G5	11.1	11.05	RW010N5LENP	4P	82	26	-	42	8.5	6.5	9	1(6)	026	○
	G5	11.1	11.05	RW010N5LENB	2P	82	26	-	42	8.5	6.5	9	1(6)	026	○
STI M12X1.25	G6	13.1	13.05	RW012N6LENP	4P	88	26	-	45	10.5	8	11	1(6)	026	○
	G6	13.1	13.05	RW012N6LENB	2P	88	26	-	45	10.5	8	11	1(6)	026	○
STI M12X1.5	G6	13.3	13.25	RW012O6LENP	4P	88	26	-	45	10.5	8	11	1(6)	026	○
	G6	13.3	13.25	RW012O6LENB	2P	88	26	-	45	10.5	8	11	1(6)	026	○

Intro

SP

SL

PO

ST

ROLL

CARBIDE

LONG

HAND TAPS

EG (STI)

JIS

SPECIAL THREADS, GAUGES

THREAD MILLS

DIES

CENTER DRILLS

Technical info

Intro

SP STI

GP General Purpose Series

SP Spiral Fluted Taps for Helical Coil Wire Screw Thread Inserts



SL



PO

Recommended Tapping Speeds Depending On Materials

ST

ISO	Vc (m/min)	ISO	Vc (m/min)
P1	5÷10 ☆	N1	5÷15 ★
P2	5÷10 ☆	N2	5÷15 ★
P3	5÷10 ☆	N3	5÷15 ★
		N4	5÷15 ★

★ 1st choice ☆ suitable

FEATURES

General purpose for blind hole application.
 NI treatment allow stable and long life on Aluminium, Aluminium casting and die-casting.
 Also suitable for carbon steel application.

ROLL

CARBIDE

LONG

HAND TAPS

EG (STI)

ANSI

SPECIAL THREADS, GAUGES



THREAD MILLS

DIES

CENTER DRILLS

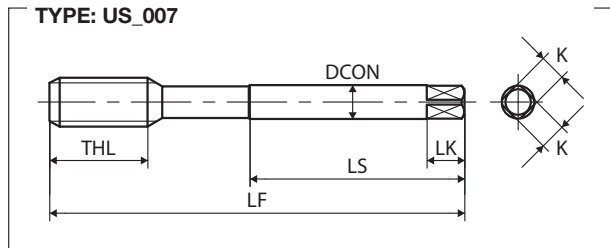
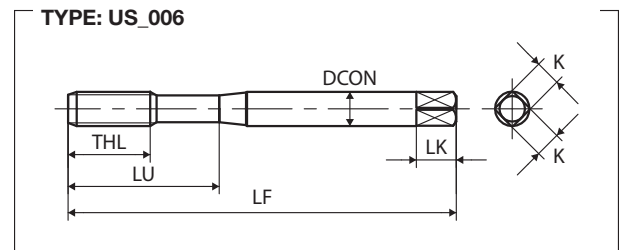
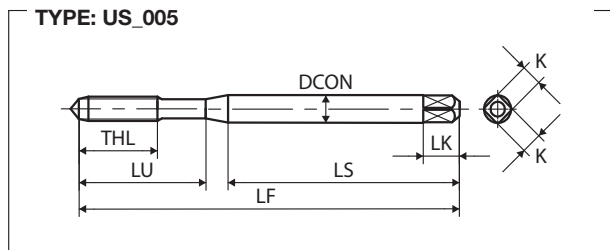
Technical info



EG(STI) UNC	TCTR (tolerance)	 Hole Ø (mm)	Hole Ø (mm)	Code	THCHT (chamfer)	LF (inch)	THL (inch)	LU (inch)	LS (inch)	DCON (inch)	K (inch)	LK (inch)	NOF	Type	Stock
ANSI															
STI No.2-56UNC	GH1	2.35	2.4	SUUN2E1NEB	2P	2.205	0.354	0.709	1.28	0.141	0.11	0.187	2	005	○
	GH2	2.35	2.4	SUUN2E2NEB	2P	2.205	0.354	0.709	1.28	0.141	0.11	0.187	2	005	○
STI No.4-40UNC	GH1	3.1	3.13	SUUN4H1NEB	2P	2.48	0.512	0.827	1.496	0.168	0.131	0.25	2	005	○
	GH2	3.1	3.13	SUUN4H2NEB	2P	2.48	0.512	0.827	1.496	0.168	0.131	0.25	2	005	○
STI No.6-32UNC	GH1	3.8	3.83	SUUN6J1NEB	2P	2.756	0.551	0.945	1.654	0.194	0.131	0.25	3	005	○
	GH2	3.8	3.83	SUUN6J2NEB	2P	2.756	0.551	0.945	1.654	0.194	0.131	0.25	3	005	○
STI No.8-32UNC	GH1	4.4	4.48	SUUN8J1NEB	2P	3.15	0.591	0.984	1.929	0.22	0.165	0.281	3	005	○
	GH2	4.4	4.48	SUUN8J2NEB	2P	3.15	0.591	0.984	1.929	0.22	0.165	0.281	3	005	○
STI No.10-24UNC	GH2	5.2	5.23	SUUNAM2NEB	2P	3.15	0.591	1.181	1.713	0.255	0.191	0.312	3	005	○
	GH3	5.2	5.23	SUUNAM3NEB	2P	3.15	0.591	1.181	1.713	0.255	0.191	0.312	3	005	○
STI 1/4-20UNC	GH2	6.8	6.81	SUU04N2NEB	2P	3.543	0.748	1.378	1.831	0.318	0.238	0.375	3	006	○
	GH3	6.8	6.81	SUU04N3NEB	2P	3.543	0.748	1.378	1.831	0.318	0.238	0.375	3	006	○
STI 5/16-18UNC	GH2	8.4	8.43	SUU0502NEB	2P	3.937	0.906	1.535	2.067	0.381	0.286	0.437	3	006	○
	GH3	8.4	8.43	SUU0503NEB	2P	3.937	0.906	1.535	2.067	0.381	0.286	0.437	3	006	○
STI 3/8-16UNC	GH2	10	10.06	SUU06P2NEB	2P	4.331	1.024	-	2.205	0.367	0.275	0.437	3	007	○
	GH3	10	10.06	SUU06P3NEB	2P	4.331	1.024	-	2.205	0.367	0.275	0.437	3	007	○
STI 7/16-14UNC	GH2	11.7	11.71	SUU07Q2NEB	2P	4.331	1.024	-	2.205	0.429	0.322	0.5	3	007	○
	GH3	11.7	11.71	SUU07Q3NEB	2P	4.331	1.024	-	2.205	0.429	0.322	0.5	3	007	○
STI 1/2-13UNC	GH2	13.2	13.33	SUU08R2NEB	2P	4.331	1.024	-	2.205	0.48	0.36	0.562	3	007	○
	GH3	13.2	13.33	SUU08R3NEB	2P	4.331	1.024	-	2.205	0.48	0.36	0.562	3	007	○
EG(STI) UNF	TCTR (tolerance)	 Hole Ø (mm)	Hole Ø (mm)	Code	THCHT (chamfer)	LF (inch)	THL (inch)	LU (inch)	LS (inch)	DCON (inch)	K (inch)	LK (inch)	NOF	Type	Stock
ANSI															
STI No.10-32UNF	GH2	5.1	5.14	SUUNAJ2NEB	2P	3.15	0.591	1.181	1.713	0.255	0.191	0.312	3	005	○
	GH3	5.1	5.14	SUUNAJ3NEB	2P	3.15	0.591	1.181	1.713	0.255	0.191	0.312	3	005	○
STI 1/4-28UNF	GH2	6.6	6.68	SUU04K2NEB	2P	3.543	0.748	1.378	1.831	0.318	0.238	0.375	3	006	○
	GH3	6.6	6.68	SUU04K3NEB	2P	3.543	0.748	1.378	1.831	0.318	0.238	0.375	3	006	○
STI 5/16-24UNF	GH2	8.3	8.31	SUU05M2NEB	2P	3.937	0.906	1.535	2.028	0.381	0.286	0.437	3	006	○
	GH3	8.3	8.31	SUU05M3NEB	2P	3.937	0.906	1.535	2.028	0.381	0.286	0.437	3	006	○
STI 3/8-24UNF	GH2	9.8	9.89	SUU06M2NEB	2P	3.937	0.906	-	2.008	0.323	0.242	0.406	3	007	○
	GH3	9.8	9.89	SUU06M3NEB	2P	3.937	0.906	-	2.008	0.323	0.242	0.406	3	007	○
STI 7/16-20UNF	GH2	11.5	11.53	SUU07N2NEB	2P	4.331	1.024	-	2.205	0.429	0.322	0.5	3	007	○
	GH3	11.5	11.53	SUU07N3NEB	2P	4.331	1.024	-	2.205	0.429	0.322	0.5	3	007	○
STI 1/2-20UNF	GH2	13.1	13.12	SUU08N2NEB	2P	4.331	1.024	-	2.205	0.48	0.36	0.562	3	007	○
	GH3	13.1	13.12	SUU08N3NEB	2P	4.331	1.024	-	2.205	0.48	0.36	0.562	3	007	○

Intro

SP

SL

PO

ST

ROLL

CARBIDE

LONG

HAND TAPS

EG (STI)

ANSI

SPECIAL THREADS, GAUGES

THREAD MILLS

DIES

CENTER DRILLS

Technical info

The most suitable GH tap class to cut accurate 2B, 3B (UNJ) and 2B oversized internal threads tolerance, depends on application conditions and work-piece materials. Yamawa GH class system offers a wide range of alternative tap classes allowing each customer to select the most suitable one according to application requirement. Check page 673 of Technical info for full details.

Intro

ZELX NI SP STI



SP

MS Material Specific Series

Spiral Fluted Taps for Nickel Base Alloys, for Helical Coil Wire Screw Thread Inserts

SL



FEATURES

Material specific for blind hole application.
 Specific design and NX treatment allow high performance on Nickel base alloys.
 Also suitable for stainless steel and high alloy steel.

PO

Recommended Tapping Speeds Depending On Materials

ISO	Vc (m/min)	ISO	Vc (m/min)	ISO	Vc (m/min)
P1	5÷15 ☆	M1	5÷15 ★	S1	5÷10 ★
P2	5÷15 ☆	M2	5÷15 ★	S2	5÷10 ★
P3	5÷15 ★	M3	4÷8 ★		
P4	5÷15 ★				
P5	5÷10 ☆				
P7	5÷15 ★				
P8	4÷8 ★				

★ 1st choice ☆ suitable

ST

ROLL

CARBIDE

LONG

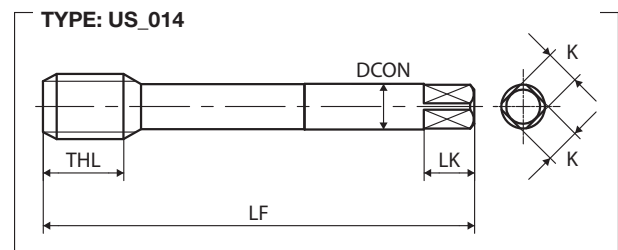
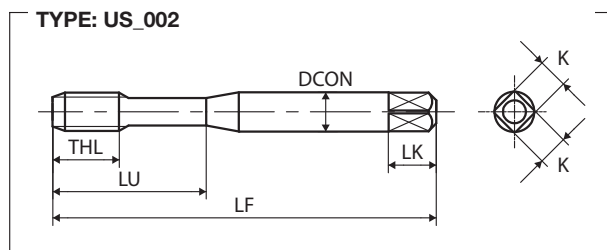

HAND TAPS

EG (STI)

ANSI

SPECIAL THREADS, GAUGES

THREAD MILLS

DIES

CENTER DRILLS

EG(STI) UNC	TCTR (tolerance)	Hole Ø (mm)	Hole Ø (mm)	Code	THCHT (chamfer)	LF (inch)	THL (inch)	LU (inch)	LS (inch)	DCON (inch)	K (inch)	LK (inch)	NOF	Type	Stock
ANSI															
STI No.2-56UNC	GH2	2.35	2.4	Y87400	3P	1.875	0.236	0.562	-	0.141	0.11	0.187	3	002	○
	GH1	3.1	3.13	Y87403	3P	2	0.276	0.687	-	0.141	0.11	0.187	3	002	○
STI No.4-40UNC	GH2	3.1	3.13	Y87404	3P	2	0.276	0.687	-	0.141	0.11	0.187	3	002	○
	GH2	3.1	3.13	Y87004	1.5P	2	0.276	0.687	-	0.141	0.11	0.187	3	002	○
	GH3	3.1	3.13	Y87420	3P	2	0.276	0.687	-	0.141	0.11	0.187	3	002	○
	GH3	3.1	3.13	Y87419	1.5P	2	0.276	0.687	-	0.141	0.11	0.187	3	002	○
STI No.6-32UNC	GH2	3.8	3.83	Y87408	3P	2.375	0.354	0.875	-	0.194	0.152	0.25	3	002	○
	GH2	3.8	3.83	Y87008	1.5P	2.375	0.354	0.875	-	0.194	0.152	0.25	3	002	○
	GH3	3.8	3.83	Y87424	3P	2.375	0.354	0.875	-	0.194	0.152	0.25	3	002	○
	GH3	3.8	3.83	Y87425	1.5P	2.375	0.354	0.875	-	0.194	0.152	0.25	3	002	○
STI No.8-32UNC	GH1	4.4	4.48	Y81409	3P	2.375	0.354	0.937	-	0.22	0.165	0.281	3	002	○
	GH2	4.4	4.48	Y87410	3P	2.375	0.354	0.937	-	0.22	0.165	0.281	3	002	○
	GH3	4.4	4.48	Y87426	3P	2.375	0.354	0.937	-	0.22	0.165	0.281	3	002	○
	GH2	4.4	4.48	Y87026	1.5P	2.375	0.354	0.937	-	0.22	0.165	0.281	3	002	○

Technical info

EG(STI) UNC	TCTR (tolerance)	Hole Ø (mm)	Hole Ø (mm)	Code	THCHT (chamfer)	LF (inch)	THL (inch)	LU (inch)	LS (inch)	DCON (inch)	K (inch)	LK (inch)	NOF	Type	Stock
ANSI															
STI No.10-24UNC	GH2	5.2	5.23	Y87412	3P	2.5	0.433	1	-	0.255	0.191	0.312	3	002	○
	GH3	5.2	5.23	Y87428	3P	2.5	0.433	1	-	0.255	0.191	0.312	3	002	○
	GH3	5.2	5.23	Y87028	1.5P	2.5	0.433	1	-	0.255	0.191	0.312	3	002	○
	GH2	5.2	5.23	Y87012	1.5P	2.5	0.433	1	-	0.255	0.191	0.312	3	002	○
	GH5	5.2	5.23	Y87445	1.5P	2.5	0.433	1	-	0.255	0.191	0.312	3	002	○
STI 1/4-20UNC	GH2	6.8	6.81	Y87448	3P	2.718	0.472	1.125	-	0.318	0.238	0.375	3	002	○
	GH3	6.8	6.81	Y87458	3P	2.718	0.472	1.125	-	0.318	0.238	0.375	3	002	○
	GH3	6.8	6.81	Y87058	1.5P	2.718	0.472	1.125	-	0.318	0.238	0.375	3	002	○
	GH5	6.8	6.81	Y87090	1.5P	2.718	0.472	1.125	-	0.318	0.238	0.375	3	002	○
STI 5/16-18UNC	GH3	8.4	8.43	Y87460	3P	2.937	0.551	1.25	-	0.381	0.286	0.437	3	002	○
	GH4	8.4	8.43	Y87470	3P	2.937	0.551	1.25	-	0.381	0.286	0.437	3	002	○
	GH2	8.4	8.43	Y87060	1.5P	2.937	0.551	1.25	-	0.381	0.286	0.437	3	002	○
STI 3/8-16UNC	GH3	10	10.06	Y87462	3P	3.375	0.630	-	-	0.367	0.275	0.437	3	014	○
	GH4	10	10.06	Y87472	3P	3.375	0.630	-	-	0.367	0.275	0.437	3	014	○
	GH3	10	10.06	Y87062	1.5P	3.375	0.630	-	-	0.367	0.275	0.437	3	014	○
STI 7/16-14UNC	GH3	11.7	11.71	Y87464	3P	3.593	0.709	-	-	0.429	0.322	0.5	3	014	○
STI 1/2-13UNC	GH3	13.2	13.33	Y87466	3P	3.812	0.748	-	-	0.48	0.36	0.562	3	014	○
	GH3	13.2	13.33	Y87066	1.5P	3.812	0.748	-	-	0.48	0.36	0.562	3	014	○
	GH5	13.2	13.33	Y87088	1.5P	3.812	0.748	-	-	0.48	0.36	0.562	3	014	○
ANSI															
EG(STI) UNF	TCTR (tolerance)	Hole Ø (mm)	Hole Ø (mm)	Code	THCHT (chamfer)	LF (inch)	THL (inch)	LU (inch)	LS (inch)	DCON (inch)	K (inch)	LK (inch)	NOF	Type	Stock
ANSI															
STI No.6-40UNF	GH2	3.7	3.77	Y87409	3P	2.125	0.276	0.75	-	0.168	0.131	0.25	3	002	○
STI No.10-32UNF	GH2	5.1	5.14	Y87413	3P	2.5	0.354	1	-	0.255	0.191	0.312	3	002	○
	GH3	5.1	5.14	Y87429	3P	2.5	0.354	1	-	0.255	0.191	0.312	3	002	○
	GH3	5.1	5.14	Y87029	1.5P	2.5	0.354	1	-	0.255	0.191	0.312	3	002	○
	GH5	5.1	5.14	Y87057	1.5P	2.5	0.354	1	-	0.255	0.191	0.312	3	002	○
STI 1/4-28UNF	GH2	6.6	6.68	Y87449	3P	2.718	0.394	1.125	-	0.318	0.238	0.375	3	002	○
	GH3	6.6	6.68	Y87459	3P	2.718	0.394	1.125	-	0.318	0.238	0.375	3	002	○
	GH2	6.6	6.68	Y87059	1.5P	2.718	0.394	1.125	-	0.318	0.238	0.375	3	002	○
	GH5	6.6	6.68	Y87091	1.5P	2.718	0.394	1.125	-	0.318	0.238	0.375	3	002	○
STI 5/16-24UNF	GH2	8.3	8.31	Y87451	3P	2.937	0.394	1.25	-	0.381	0.286	0.437	3	002	○
	GH3	8.3	8.31	Y87461	3P	2.937	0.394	1.25	-	0.381	0.286	0.437	3	002	○
	GH3	8.3	8.31	Y87061	1.5P	2.937	0.394	1.25	-	0.381	0.286	0.437	3	002	○
STI 3/8-24UNF	GH2	9.8	9.89	Y87453	3P	3.156	0.472	-	-	0.323	0.242	0.406	3	014	○
	GH2	9.8	9.89	Y87063	1.5P	3.156	0.472	-	-	0.323	0.242	0.406	3	014	○
	GH3	9.8	9.89	Y87463	3P	3.156	0.472	-	-	0.323	0.242	0.406	3	014	○
	GH5	9.8	9.89	Y87085	1.5P	3.156	0.472	-	-	0.323	0.242	0.406	3	014	○
STI 7/16-20UNF	GH3	11.5	11.53	Y87465	3P	3.375	0.472	-	-	0.367	0.275	0.437	3	014	○
	GH4	11.5	11.53	Y87475	3P	3.375	0.472	-	-	0.367	0.275	0.437	3	014	○
	GH3	11.5	11.53	Y87065	1.5P	3.375	0.472	-	-	0.367	0.275	0.437	3	014	○
STI 1/2-20UNF	GH3	13.1	13.12	Y87467	3P	3.593	0.512	-	-	0.429	0.322	0.5	3	014	○
	GH3	13.1	13.12	Y87067	1.5P	3.593	0.512	-	-	0.429	0.322	0.5	3	014	○

The most suitable GH tap class to cut accurate 2B, 3B (UNJ) and 2B oversized internal threads tolerance, depends on application conditions and work-piece materials. Yamawa GH class system offers a wide range of alternative tap classes allowing each customer to select the most suitable one according to application requirement. Check page 673 of Technical info for full details.

Intro
SP
SL
PO
ST
ROLL
CARBIDE
LONG
HAND TAPS
EG (STI)
ANSI
SPECIAL THREADS, GAUGES
THREAD MILLS
DIES
CENTER DRILLS
Technical info

Intro

PO STI

GP General Purpose Series

Spiral Pointed Taps for Helical Coil Wire Screw Thread Inserts



SP

SL



PO

Recommended Tapping Speeds Depending On Materials

ST

ISO	Vc (m/min)	ISO	Vc (m/min)
P1	5÷10 ☆	N1	5÷15 ★
P2	5÷10 ☆	N2	5÷15 ★
P3	5÷10 ☆	N3	5÷15 ★
		N4	5÷15 ★

★ 1st choice ☆ suitable

FEATURES

General purpose for through hole application.
 NI treatment allow stable and long life on Aluminium, Aluminium casting and die-casting.
 Also suitable for carbon steel application.

ROLL

CARBIDE

LONG

HAND TAPS

EG (STI)

ANSI

SPECIAL THREADS, GAUGES

THREAD MILLS

DIES

CENTER DRILLS

Technical info

TYPE: US_005

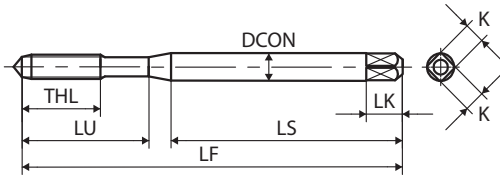

TYPE: US_006

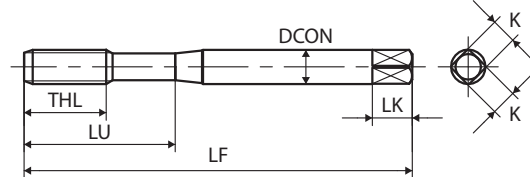

TYPE: US_007

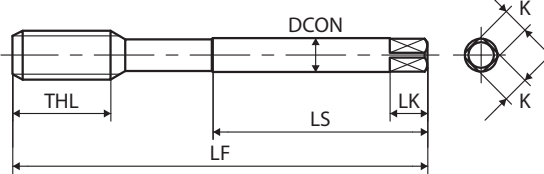

EG(STI) UNC	TCTR (tolerance)	Hole Ø (mm)	Hole Ø (mm)	Code	THCHT (chamfer)	LF (inch)	THL (inch)	LU (inch)	LS (inch)	DCON (inch)	K (inch)	LK (inch)	NOF	Type	Stock
ANSI															
STI No.2-56UNC	GH1	2.35	2.4	PUUN2E1NEB	5P	2.205	0.354	0.709	1.28	0.141	0.11	0.187	2	005	○
	GH2	2.35	2.4	PUUN2E2NEB	5P	2.205	0.354	0.709	1.28	0.141	0.11	0.187	2	005	○
STI No.4-40UNC	GH1	3.1	3.13	PUUN4H1NEB	5P	2.48	0.512	0.827	1.496	0.168	0.131	0.25	2	005	○
	GH2	3.1	3.13	PUUN4H2NEB	5P	2.48	0.512	0.827	1.496	0.168	0.131	0.25	2	005	○
STI No.6-32UNC	GH1	3.8	3.83	PUUN6J1NEB	5P	2.756	0.551	0.945	1.654	0.194	0.131	0.25	2	005	○
	GH2	3.8	3.83	PUUN6J2NEB	5P	2.756	0.551	0.945	1.654	0.194	0.131	0.25	2	005	○
STI No.8-32UNC	GH1	4.4	4.48	PUUN8J1NEB	5P	3.15	0.591	0.984	1.929	0.22	0.165	0.281	2	005	○
	GH2	4.4	4.48	PUUN8J2NEB	5P	3.15	0.591	0.984	1.929	0.22	0.165	0.281	2	005	○
STI No.10-24UNC	GH2	5.2	5.23	PUUNAM2NEB	5P	3.15	0.591	1.181	1.713	0.255	0.191	0.312	2	005	○
	GH3	5.2	5.23	PUUNAM3NEB	5P	3.15	0.591	1.181	1.713	0.255	0.191	0.312	2	005	○
STI 1/4-20UNC	GH2	6.8	6.81	PUU04N2NEB	5P	3.543	0.748	1.378	1.831	0.318	0.238	0.375	2	006	○
	GH3	6.8	6.81	PUU04N3NEB	5P	3.543	0.748	1.378	1.831	0.318	0.238	0.375	2	006	○
STI 5/16-18UNC	GH2	8.4	8.43	PUU05O2NEB	5P	3.937	0.906	1.535	2.067	0.381	0.286	0.437	2	006	○
	GH3	8.4	8.43	PUU05O3NEB	5P	3.937	0.906	1.535	2.067	0.381	0.286	0.437	2	006	○
STI 3/8-16UNC	GH3	10	10.06	PUU06P3NEB	5P	4.331	1.024	-	2.205	0.367	0.275	0.437	3	007	○
	GH4	10	10.06	PUU06P4NEB	5P	4.331	1.024	-	2.205	0.367	0.275	0.437	3	007	○
STI 7/16-14UNC	GH3	11.7	11.71	PUU07Q3NEB	5P	4.331	1.024	-	2.205	0.429	0.322	0.5	3	007	○
	GH4	11.7	11.71	PUU07Q4NEB	5P	4.331	1.024	-	2.205	0.429	0.322	0.5	3	007	○
STI 1/2-13UNC	GH3	13.2	13.33	PUU08R3NEB	5P	4.331	1.024	-	2.205	0.48	0.36	0.562	3	007	○
	GH4	13.2	13.33	PUU08R4NEB	5P	4.331	1.024	-	2.205	0.48	0.36	0.562	3	007	○

EG(STI) UNF	TCTR (tolerance)	Hole Ø (mm)	Hole Ø (mm)	Code	THCHT (chamfer)	LF (inch)	THL (inch)	LU (inch)	LS (inch)	DCON (inch)	K (inch)	LK (inch)	NOF	Type	Stock
ANSI															
STI No.10-32UNF	GH2	5.1	5.14	PUUNAJ2NEB	5P	3.15	0.591	1.181	1.713	0.255	0.191	0.312	2	005	○
	GH3	5.1	5.14	PUUNAJ3NEB	5P	3.15	0.591	1.181	1.713	0.255	0.191	0.312	2	005	○
STI 1/4-28UNF	GH2	6.6	6.68	PUU04K2NEB	5P	3.543	0.748	1.378	1.831	0.318	0.238	0.375	2	006	○
	GH3	6.6	6.68	PUU04K3NEB	5P	3.543	0.748	1.378	1.831	0.318	0.238	0.375	2	006	○
STI 5/16-24UNF	GH2	8.3	8.31	PUU05M2NEB	5P	3.937	0.906	1.535	2.028	0.381	0.286	0.437	2	006	○
	GH3	8.3	8.31	PUU05M3NEB	5P	3.937	0.906	1.535	2.028	0.381	0.286	0.437	2	006	○
STI 3/8-24UNF	GH2	9.8	9.89	PUU06M2NEB	5P	3.937	0.906	-	2.008	0.323	0.242	0.406	3	007	○
	GH3	9.8	9.89	PUU06M3NEB	5P	3.937	0.906	-	2.008	0.323	0.242	0.406	3	007	○
STI 7/16-20UNF	GH3	11.5	11.53	PUU07N3NEB	5P	4.331	1.024	-	2.205	0.429	0.322	0.5	3	007	○
	GH4	11.5	11.53	PUU07N4NEB	5P	4.331	1.024	-	2.205	0.429	0.322	0.5	3	007	○
STI 1/2-20UNF	GH3	13.1	13.12	PUU08N3NEB	5P	4.331	1.024	-	2.205	0.48	0.36	0.562	3	007	○
	GH4	13.1	13.12	PUU08N4NEB	5P	4.331	1.024	-	2.205	0.48	0.36	0.562	3	007	○

Intro

SP

SL

PO

ST

ROLL

CARBIDE

LONG

HAND TAPS

EG (STI)

ANSI

SPECIAL THREADS, GAUGES

THREAD MILLS

DIES

CENTER DRILLS

Technical info

The most suitable GH tap class to cut accurate 2B, 3B (UNJ) and 2B oversized internal threads tolerance, depends on application conditions and work-piece materials. Yamawa GH class system offers a wide range of alternative tap classes allowing each customer to select the most suitable one according to application requirement. Check page 673 of Technical info for full details.

Intro

ZELX NI PO STI



SP

MS Material Specific Series

Spiral Pointed Taps for Nickel Base Alloys for Helical Coil Wire Screw Thread Inserts

SL



PO

Recommended Tapping Speeds Depending On Materials

ISO	Vc (m/min)	★	ISO	Vc (m/min)	★	ISO	Vc (m/min)	★
P3	5÷15	★	M1	5÷15	★	S1	5÷10	★
P4	5÷15	★	M2	5÷15	★	S2	5÷10	★
P5	5÷10	☆	M3	4÷8	★	S3	3÷6	☆
P7	5÷15	★						
P8	4÷8	★						

★ 1st choice ☆ suitable

ST

ROLL

CARBIDE

LONG

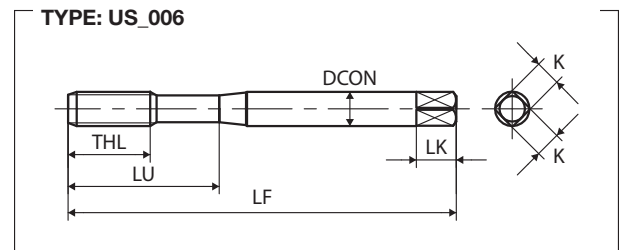
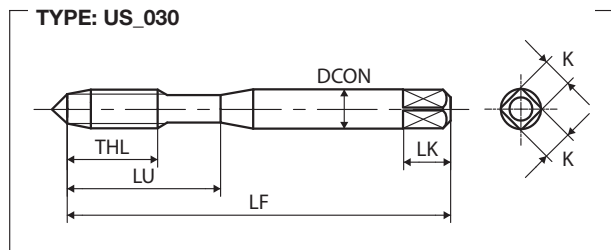

HAND TAPS

EG (STI)

ANSI

SPECIAL THREADS, GAUGES

THREAD MILLS



DIES

CENTER DRILLS

Technical info

FEATURES

Material specific for through hole application.
 Specific design and NI+OX treatment allow high performance on Nickel base alloys.
 Also suitable for stainless steel and high alloy steel.

EG(STI) UNC	TCTR (tolerance)	 Hole Ø (mm)	Hole Ø (mm)	Code	THCHT (chamfer)	LF (inch)	THL (inch)	LU (inch)	LS (inch)	DCON (inch)	K (inch)	LK (inch)	NOF	Type	Stock
ANSI															
STI No.2-56UNC	GH2	2.35	2.4	Y87200	4.5P	1.875	0.335	0.562	-	0.141	0.11	0.187	2	030	○
STI No.4-40UNC	GH1	3.1	3.13	Y87203	4.5P	2	0.413	0.687	-	0.141	0.11	0.187	3	030	○
	GH2	3.1	3.13	Y87204	4.5P	2	0.413	0.687	-	0.141	0.11	0.187	3	030	○
STI No.6-32UNC	GH2	3.8	3.83	Y87208	4.5P	2.375	0.531	0.875	-	0.194	0.152	0.25	3	030	○
	GH3	3.8	3.83	Y87224	4.5P	2.375	0.531	0.875	-	0.194	0.152	0.25	3	030	○
STI No.8-32UNC	GH2	4.4	4.48	Y87210	4.5P	2.375	0.571	0.937	-	0.22	0.165	0.281	3	030	○
	GH3	4.4	4.48	Y87226	4.5P	2.375	0.571	0.937	-	0.22	0.165	0.281	3	030	○
STI No.10-24UNC	GH2	5.2	5.23	Y87212	4.5P	2.5	0.591	1	-	0.255	0.191	0.312	3	030	○
	GH3	5.2	5.23	Y87228	4.5P	2.5	0.591	1	-	0.255	0.191	0.312	3	030	○
STI 1/4-20UNC	GH2	6.8	6.81	Y87248	4.5P	2.718	0.669	1.125	-	0.318	0.238	0.375	3	030	○
	GH3	6.8	6.81	Y87258	4.5P	2.718	0.669	1.125	-	0.318	0.238	0.375	3	030	○
STI 5/16-18UNC	GH3	8.4	8.43	Y87260	4.5P	2.937	0.748	1.25	-	0.381	0.286	0.437	3	030	○
	GH4	8.4	8.43	Y87272	4.5P	2.937	0.748	1.25	-	0.381	0.286	0.437	3	030	○
STI 3/8-16UNC	GH3	10	10.06	Y87262	4.5P	3.375	0.984	-	-	0.367	0.275	0.437	3	006	○
	GH4	10	10.06	Y87270	4.5P	3.375	0.984	-	-	0.367	0.275	0.437	3	006	○
STI 7/16-14UNC	GH3	11.7	11.71	Y87264	4.5P	3.593	0.984	-	-	0.429	0.322	0.5	3	006	○
STI 1/2-13UNC	GH3	13.2	13.33	Y87266	4.5P	3.812	1.083	-	-	0.48	0.36	0.562	3	006	○
ANSI															
EG(STI) UNF	TCTR (tolerance)	 Hole Ø (mm)	Hole Ø (mm)	Code	THCHT (chamfer)	LF (inch)	THL (inch)	LU (inch)	LS (inch)	DCON (inch)	K (inch)	LK (inch)	NOF	Type	Stock
ANSI															
STI No.6-40UNF	GH2	3.7	3.77	Y87209	4.5P	2.125	0.453	0.75	-	0.168	0.131	0.25	3	030	○
STI No.10-32UNF	GH2	5.1	5.14	Y87213	4.5P	2.5	0.591	1	-	0.255	0.191	0.312	3	030	○
	GH3	5.1	5.14	Y87229	4.5P	2.5	0.591	1	-	0.255	0.191	0.312	3	030	○
STI 1/4-28UNF	GH2	6.6	6.68	Y87249	4.5P	2.718	0.669	1.125	-	0.318	0.238	0.375	3	030	○
	GH3	6.6	6.68	Y87259	4.5P	2.718	0.669	1.125	-	0.318	0.238	0.375	3	030	○
STI 5/16-24UNF	GH2	8.3	8.31	Y87251	4.5P	2.937	0.748	1.25	-	0.381	0.286	0.437	3	030	○
	GH3	8.3	8.31	Y87261	4.5P	2.937	0.748	1.25	-	0.381	0.286	0.437	3	030	○
STI 3/8-24UNF	GH2	9.8	9.89	Y87253	4.5P	3.156	0.866	-	-	0.323	0.242	0.406	3	006	○
	GH3	9.8	9.89	Y87263	4.5P	3.156	0.866	-	-	0.323	0.242	0.406	3	006	○
STI 7/16-20UNF	GH3	11.5	11.53	Y87265	4.5P	3.375	0.984	-	-	0.367	0.275	0.437	3	006	○
	GH4	11.5	11.53	Y87275	4.5P	3.375	0.984	-	-	0.367	0.275	0.437	3	006	○
STI 1/2-20UNF	GH3	13.1	13.12	Y87267	4.5P	3.593	0.984	-	-	0.429	0.322	0.5	3	006	○

The most suitable GH tap class to cut accurate 2B, 3B (UNJ) and 2B oversized internal threads tolerance, depends on application conditions and work-piece materials. Yamawa GH class system offers a wide range of alternative tap classes allowing each customer to select the most suitable one according to application requirement. Check page 673 of Technical info for full details.

Intro

SP

SL

PO

ST

ROLL

CARBIDE

LONG

HAND TAPS

EG (STI)

ANSI

SPECIAL THREADS, GAUGES

THREAD MILLS

DIES

CENTER DRILLS

Technical info

Intro

HT STI

GP General Purpose Series

Straight Fluted Taps for Helical Coil Wire Screw Thread Inserts



SP

SL



PO

Recommended Tapping Speeds Depending On Materials

ISO	Vc (m/min)	ISO	Vc (m/min)
P1	5÷10 ☆	N1	5÷15 ★
P2	5÷10 ☆	N2	5÷15 ★
P3	5÷10 ☆	N3	5÷10 ★
		N4	5÷10 ★

★ 1st choice ☆ suitable

ST

ROLL

CARBIDE

LONG

HAND TAPS

EG (STI)

ANSI

SPECIAL THREADS, GAUGES

THREAD MILLS

DIES

CENTER DRILLS

Technical info

FEATURES

General purpose for blind and through hole application. For non-ferrous materials. 1.5P chamfer for blind hole application, 5P chamfer for through hole application.

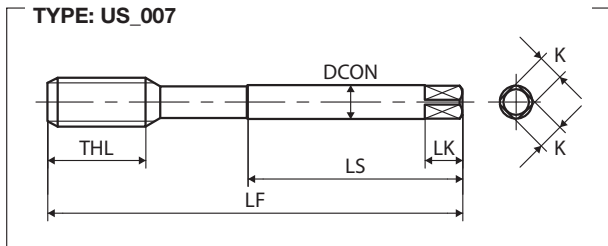
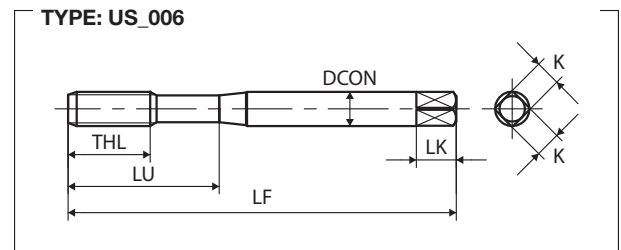
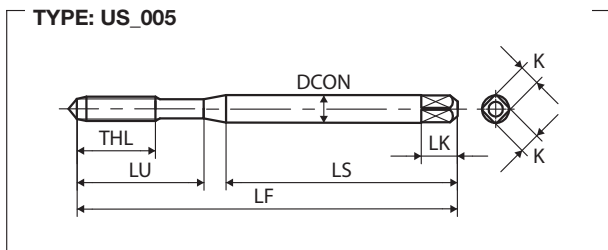

EG(STI) UNC	TCTR (tolerance)	\varnothing (mm)	Hole \varnothing (mm)	Code	THCHT (chamfer)	LF (inch)	THL (inch)	LU (inch)	LS (inch)	DCON (inch)	K (inch)	LK (inch)	NOF	Type	Stock	
ANSI																Intro
STI No.2-56UNC	GH1	2.35	2.4	TUUN2E1NEB5	5P	2.205	0.354	0.709	1.28	0.141	0.11	0.187	3	005	○	
	GH1	2.35	2.4	TUUN2E1NEBA	1.5P	2.205	0.354	0.709	1.28	0.141	0.11	0.187	3	005	○	SP
	GH2	2.35	2.4	TUUN2E2NEB5	5P	2.205	0.354	0.709	1.28	0.141	0.11	0.187	3	005	○	
	GH2	2.35	2.4	TUUN2E2NEBA	1.5P	2.205	0.354	0.709	1.28	0.141	0.11	0.187	3	005	○	
STI No.4-40UNC	GH1	3.1	3.13	TUUN4H1NEB5	5P	2.48	0.512	0.827	1.496	0.168	0.131	0.25	3	005	○	
	GH1	3.1	3.13	TUUN4H1NEBA	1.5P	2.48	0.512	0.827	1.496	0.168	0.131	0.25	3	005	○	SL
	GH2	3.1	3.13	TUUN4H2NEB5	5P	2.48	0.512	0.827	1.496	0.168	0.131	0.25	3	005	○	
	GH2	3.1	3.13	TUUN4H2NEBA	1.5P	2.48	0.512	0.827	1.496	0.168	0.131	0.25	3	005	○	
STI No.6-32UNC	GH1	3.8	3.83	TUUN6J1NEB5	5P	2.756	0.551	0.945	1.654	0.194	0.131	0.25	3	005	○	
	GH1	3.8	3.83	TUUN6J1NEBA	1.5P	2.756	0.551	0.945	1.654	0.194	0.131	0.25	3	005	○	PO
	GH2	3.8	3.83	TUUN6J2NEB5	5P	2.756	0.551	0.945	1.654	0.194	0.131	0.25	3	005	○	
	GH2	3.8	3.83	TUUN6J2NEBA	1.5P	2.756	0.551	0.945	1.654	0.194	0.131	0.25	3	005	○	
STI No.8-32UNC	GH1	4.4	4.48	TUUN8J1NEB5	5P	3.15	0.591	0.984	1.929	0.22	0.165	0.281	3	005	○	
	GH1	4.4	4.48	TUUN8J1NEBA	1.5P	3.15	0.591	0.984	1.929	0.22	0.165	0.281	3	005	○	ST
	GH2	4.4	4.48	TUUN8J2NEB5	5P	3.15	0.591	0.984	1.929	0.22	0.165	0.281	3	005	○	
	GH2	4.4	4.48	TUUN8J2NEBA	1.5P	3.15	0.591	0.984	1.929	0.22	0.165	0.281	3	005	○	
STI No.10-24UNC	GH2	5.2	5.23	TUUNAM2NEB5	5P	3.15	0.591	1.181	1.713	0.255	0.191	0.312	3	005	○	
	GH2	5.2	5.23	TUUNAM2NEBA	1.5P	3.15	0.591	1.181	1.713	0.255	0.191	0.312	3	005	○	ROLL
	GH3	5.2	5.23	TUUNAM3NEB5	5P	3.15	0.591	1.181	1.713	0.255	0.191	0.312	3	005	○	
	GH3	5.2	5.23	TUUNAM3NEBA	1.5P	3.15	0.591	1.181	1.713	0.255	0.191	0.312	3	005	○	CARBIDE
STI 1/4-20UNC	GH2	6.8	6.81	TUU04N2NEB5	5P	3.543	0.748	1.378	1.831	0.318	0.238	0.375	3	006	○	
	GH2	6.8	6.81	TUU04N2NEBA	1.5P	3.543	0.748	1.378	1.831	0.318	0.238	0.375	3	006	○	LONG
	GH3	6.8	6.81	TUU04N3NEB5	5P	3.543	0.748	1.378	1.831	0.318	0.238	0.375	3	006	○	
	GH3	6.8	6.81	TUU04N3NEBA	1.5P	3.543	0.748	1.378	1.831	0.318	0.238	0.375	3	006	○	
STI 5/16-18UNC	GH2	8.4	8.43	TUU0502NEB5	5P	3.937	0.906	1.535	2.067	0.381	0.286	0.437	4	006	○	
	GH2	8.4	8.43	TUU0502NEBA	1.5P	3.937	0.906	1.535	2.067	0.381	0.286	0.437	4	006	○	
	GH3	8.4	8.43	TUU0503NEB5	5P	3.937	0.906	1.535	2.067	0.381	0.286	0.437	4	006	○	HAND TAPS
	GH3	8.4	8.43	TUU0503NEBA	1.5P	3.937	0.906	1.535	2.067	0.381	0.286	0.437	4	006	○	
STI 3/8-16UNC	GH3	10	10.06	TUU06P3NEB5	5P	4.331	1.024	-	2.205	0.367	0.275	0.437	4	007	○	
	GH3	10	10.06	TUU06P3NEBA	1.5P	4.331	1.024	-	2.205	0.367	0.275	0.437	4	007	○	EG (STI)
	GH4	10	10.06	TUU06P4NEB5	5P	4.331	1.024	-	2.205	0.367	0.275	0.437	4	007	○	
	GH4	10	10.06	TUU06P4NEBA	1.5P	4.331	1.024	-	2.205	0.367	0.275	0.437	4	007	○	ANSI
STI 7/16-14UNC	GH3	11.7	11.71	TUU07Q3NEB5	5P	4.331	1.024	-	2.205	0.429	0.322	0.5	4	007	○	
	GH3	11.7	11.71	TUU07Q3NEBA	1.5P	4.331	1.024	-	2.205	0.429	0.322	0.5	4	007	○	SPECIAL THREADS, GAUGES
	GH4	11.7	11.71	TUU07Q4NEB5	5P	4.331	1.024	-	2.205	0.429	0.322	0.5	4	007	○	
	GH4	11.7	11.71	TUU07Q4NEBA	1.5P	4.331	1.024	-	2.205	0.429	0.322	0.5	4	007	○	
STI 1/2-13UNC	GH3	13.2	13.33	TUU08R3NEB5	5P	4.331	1.024	-	2.205	0.48	0.36	0.562	4	007	○	
	GH3	13.2	13.33	TUU08R3NEBA	1.5P	4.331	1.024	-	2.205	0.48	0.36	0.562	4	007	○	THREAD MILLS
	GH4	13.2	13.33	TUU08R4NEB5	5P	4.331	1.024	-	2.205	0.48	0.36	0.562	4	007	○	
	GH4	13.2	13.33	TUU08R4NEBA	1.5P	4.331	1.024	-	2.205	0.48	0.36	0.562	4	007	○	
EG(STI) UNF	TCTR (tolerance)	\varnothing (mm)	Hole \varnothing (mm)	Code	THCHT (chamfer)	LF (inch)	THL (inch)	LU (inch)	LS (inch)	DCON (inch)	K (inch)	LK (inch)	NOF	Type	Stock	DIES
ANSI																
STI No.10-32UNF	GH2	5.1	5.14	TUUNAJ2NEB5	5P	3.15	0.591	1.181	1.713	0.255	0.191	0.312	3	005	○	
	GH2	5.1	5.14	TUUNAJ2NEBA	1.5P	3.15	0.591	1.181	1.713	0.255	0.191	0.312	3	005	○	CENTER DRILLS
	GH3	5.1	5.14	TUUNAJ3NEB5	5P	3.15	0.591	1.181	1.713	0.255	0.191	0.312	3	005	○	
	GH3	5.1	5.14	TUUNAJ3NEBA	1.5P	3.15	0.591	1.181	1.713	0.255	0.191	0.312	3	005	○	

The most suitable GH tap class to cut accurate 2B, 3B (UNJ) and 2B oversized internal threads tolerance, depends on application conditions and work-piece materials. Yamawa GH class system offers a wide range of alternative tap classes allowing each customer to select the most suitable one according to application requirement. Check page 673 of Technical info for full details.

Intro

SP

SL

PO

ST

ROLL

CARBIDE

LONG

HAND TAPS

EG (STI)

ANSI

SPECIAL THREADS, GAUGES

THREAD MILLS

DIES

CENTER DRILLS

Technical info

EG(STI) UNF	TCTR (tolerance)	Hole Ø (mm)	Hole Ø (mm)	Code	THCHT (chamfer)	LF (inch)	THL (inch)	LU (inch)	LS (inch)	DCON (inch)	K (inch)	LK (inch)	NOF	Type	Stock
ANSI															
STI 1/4-28UNF	GH2	6.6	6.68	TUU04K2NEB5	5P	3.543	0.748	1.378	1.831	0.318	0.238	0.375	3	006	○
	GH2	6.6	6.68	TUU04K2NEBA	1.5P	3.543	0.748	1.378	1.831	0.318	0.238	0.375	3	006	○
	GH3	6.6	6.68	TUU04K3NEB5	5P	3.543	0.748	1.378	1.831	0.318	0.238	0.375	3	006	○
	GH3	6.6	6.68	TUU04K3NEBA	1.5P	3.543	0.748	1.378	1.831	0.318	0.238	0.375	3	006	○
STI 5/16-24UNF	GH2	8.3	8.31	TUU05M2NEB5	5P	3.937	0.906	1.535	2.028	0.381	0.286	0.437	4	006	○
	GH2	8.3	8.31	TUU05M2NEBA	1.5P	3.937	0.906	1.535	2.028	0.381	0.286	0.437	4	006	○
	GH3	8.3	8.31	TUU05M3NEB5	5P	3.937	0.906	1.535	2.028	0.381	0.286	0.437	4	006	○
	GH3	8.3	8.31	TUU05M3NEBA	1.5P	3.937	0.906	1.535	2.028	0.381	0.286	0.437	4	006	○
STI 3/8-24UNF	GH2	9.8	9.89	TUU06M2NEB5	5P	3.937	0.906	-	2.008	0.323	0.242	0.406	4	007	○
	GH2	9.8	9.89	TUU06M2NEBA	1.5P	3.937	0.906	-	2.008	0.323	0.242	0.406	4	007	○
	GH3	9.8	9.89	TUU06M3NEB5	5P	3.937	0.906	-	2.008	0.323	0.242	0.406	4	007	○
	GH3	9.8	9.89	TUU06M3NEBA	1.5P	3.937	0.906	-	2.008	0.323	0.242	0.406	4	007	○
STI 7/16-20UNF	GH3	11.5	11.53	TUU07N3NEB5	5P	4.331	1.024	-	2.205	0.429	0.322	0.5	4	007	○
	GH3	11.5	11.53	TUU07N3NEBA	1.5P	4.331	1.024	-	2.205	0.429	0.322	0.5	4	007	○
	GH4	11.5	11.53	TUU07N4NEB5	5P	4.331	1.024	-	2.205	0.429	0.322	0.5	4	007	○
	GH4	11.5	11.53	TUU07N4NEBA	1.5P	4.331	1.024	-	2.205	0.429	0.322	0.5	4	007	○
STI 1/2-20UNF	GH3	13.1	13.12	TUU08N3NEB5	5P	4.331	1.024	-	2.205	0.48	0.36	0.562	4	007	○
	GH3	13.1	13.12	TUU08N3NEBA	1.5P	4.331	1.024	-	2.205	0.48	0.36	0.562	4	007	○
	GH4	13.1	13.12	TUU08N4NEB5	5P	4.331	1.024	-	2.205	0.48	0.36	0.562	4	007	○
	GH4	13.1	13.12	TUU08N4NEBA	1.5P	4.331	1.024	-	2.205	0.48	0.36	0.562	4	007	○

SPECIAL THREADS, GAUGES



SPECIAL THREADS, GAUGES - DIN **536**
SPECIAL THREADS, GAUGES - JIS **538**
SPECIAL THREADS, GAUGES - YMW **556**

Selection Chart

Intro

SP

SL

PO

ST

ROLL

CARBIDE

LONG

HAND TAPS

EG (STI)













SPECIAL THREADS, GAUGES

THREAD MILLS

DIES

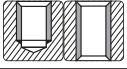

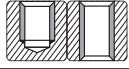
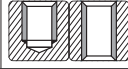
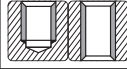

CENTER DRILLS

Technical info

	GP General Purpose					MP Multi Purpose	GP General Purpose	
	HT Pg	6000	NT	MS+TR	MS+RS	HPsRZ	SL Tr	SL LH Tr
	HSS-E	HSS	HSS-E	HSS-E	HSS-E	HSS-E COATING	HSS-E	HSS-E
				 S-Miniature (cutting)	 S-Miniature (forming)	 S-Miniature (forming)		
								
	DIN	DIN	JIS	JIS	JIS	JIS	JIS	JIS
M		537	539					
MF			539					
UNC/UNF								
UNS, 8, 12, 20, 32UN								
UNEF								
G (BSP)								
Rp (BSPP)								
Rc (BSPT)								
NPT								
NPTF								
NPSC, NPSM, NPSF								
BSW			540					
EG(STI), M, MF, UNC/UNF								
Pg	536							
Tr							544	545
S miniature				541	542	543		
Special threads								
	Vc (m/min)							
P1	☆ 5÷10	★ 5÷10	★ 5÷10			★ 15÷30	★ ≤5	★ ≤5
P2	★ 5÷10	★ 5÷10	★ 5÷10			★ 15÷30	★ ≤5	★ ≤5
P3	☆ 5÷10					★ 15÷25		
P4	☆ 5÷10					★ 15÷25		
P5								
P6								
P7		★ 3÷7	★ 3÷7			★ 10÷25		
P8								
M1		★ 3÷7	★ 3÷7			★ 10÷25		
M2						★ 10÷25		
M3								
K1	☆ 5÷10							
K2	☆ 5÷10							
K3	☆ 5÷10							
K4								
N1				★ ≤5	★ ≤10	☆ 10÷45		
N2	☆ 5÷10			★ ≤5	★ ≤10	☆ 10÷45		
N3	☆ 5÷10			★ ≤5	★ ≤10			
N4	☆ 5÷10			★ ≤5				
N5								
S1 (<25 HRC)								
S2 (<35 HRC)								
S3 (35 ÷ 45 HRC)								
S5								
H (45 ÷ 55 HRC)								
H (55 ÷ 63 HRC)								

★ 1st choice ☆ suitable

Selection Chart

	Inspection Tools			
	SIT	SITD	CPC-S	CPR-S
Intro				
SP	HSS	HSS	HSS	HSS
SL				
PO				
ST				
ROLL				
	YMW	YMW	YMW	YMW
M	557	563	569	581
MF	557	563	569	581
UNC/UNF	560	564	574	581
UNF				
G (BSP)				
Rp (BSPP)				
Rc (BSPT)				
NPT				
NPTF				
NPSC, NPSM, NPSF				
BSW				
EG(STI), M, MF, UNC/UNF				
Pg				
Tr				
S miniature				
Special threads				
	Vc (m/min)			
EG (STI)	P1			
	P2			
	P3			
	P4			
	P5			
	P6			
	P7			
	P8			
	M1			
	M2			
	M3			
	K1			
	K2			
	K3			
	K4			
	N1			
	N2			
	N3			
	N4			
	N5			
	S1 (<25 HRC)			
	S2 (<35 HRC)			
	S3 (35 ÷ 45 HRC)			
	S5			
	H (45 ÷ 55 HRC)			
	H (55 ÷ 63 HRC)			

★ 1st choice ☆ suitable

Intro

SP

SL

PO

ST

ROLL

CARBIDE

LONG

HAND
TAPS

EG (STI)

**SPECIAL
THREADS,
GAUGES**

THREAD
MILLS

DIES

CENTER
DRILLS

Technical
info

Intro

HT Pg

GP General Purpose Series

Straight Fluted Taps for Pg Threads



SP

SL



PO

Recommended Tapping Speeds Depending On Materials

ISO	Vc (m/min)	ISO	Vc (m/min)	ISO	Vc (m/min)
P1	5÷10 ☆	K1	5÷10 ☆	N2	5÷10 ☆
P2	5÷10 ★	K2	5÷10 ☆	N3	5÷10 ☆
P3	5÷10 ☆	K3	5÷10 ☆	N4	5÷10 ☆
P4	5÷10 ☆				

★ 1st choice ☆ suitable

ROLL

CARBIDE

LONG

HAND TAPS

EG (STI)

SPECIAL THREADS, GAUGES

DIN

THREAD MILLS

DIES

CENTER DRILLS

Technical info

FEATURES

General purpose for blind and through hole application.
For steel application at low cutting speed, also suitable for cast iron and non-ferrous materials.

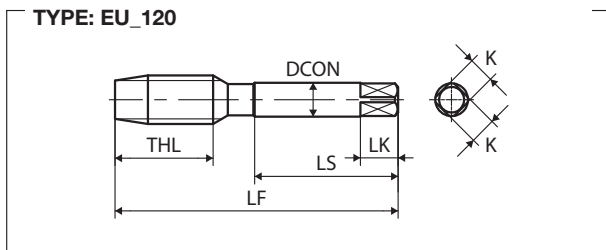

Pg	TCTR (tolerance)	Hole Ø (mm)	Hole Ø (mm)	Code	THCHT (chamfer)	LF (mm)	THL (mm)	LU (mm)	LS (mm)	DCON (mm)	K (mm)	LK (mm)	NOF	Type	Stock
DIN 40432															
Pg 7-20	-	11.4	11.45	TYPG070NEBU	3.5P	70	21	-	36	9	7	10	4	120	●
Pg 9-18	-	14	14.1	TYPG090NEBU	3.5P	70	21	-	36	12	9	12	4	120	●
Pg 11-18	-	17.3	17.35	TYPG110NEBU	3.5P	80	21	-	41	14	11	14	4	120	●
Pg 13.5-18	-	19.1	19.15	TYPG130NEBU	3.5P	80	21	-	41	16	12	15	4	120	●
Pg 16-18	-	21.25	21.3	TYPG160NEBU	3.5P	80	21	-	41	18	14.5	17	4	120	●
Pg 21-16	-	27	27.1	TYPG210NEBU	3.5P	90	21	-	46	22	18	21	4	120	●
Pg 29-16	-	35.6	35.7	TYPG290NEBU	3.5P	100	24	-	51	28	22	25	4	120	○
Pg 36-16	-	45.6	45.7	TYPG360NEBU	3.5P	140	39	-	71	36	29	32	4	120	○

6000

GP General Purpose Series

Nut Taps



FEATURES

Straight fluted tap for nut tapping machines.
Chamfer length 22P ÷ 32P

Recommended Tapping Speeds Depending On Materials

ISO	Vc (m/min)	★	ISO	Vc (m/min)	★
P1	5÷10	★	M1	3÷7	★
P2	5÷10	★			
P7	3÷7	★			

★ 1st choice ☆ suitable

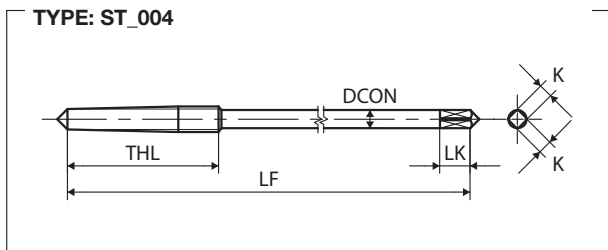

M	TCTR (tolerance)	Hole Ø (mm)	Hole Ø (mm)	Code	THCHT (chamfer)	LF (mm)	THL (mm)	LU (mm)	LS (mm)	DCON (mm)	K (mm)	LK (mm)	NOF	Type	Stock
DIN 357															
M3X0.5	IS02(6H)	2.5	2.56	60003.0	32P	70	22	-	-	2.2	-	-	3	004	●
M4X0.7	IS02(6H)	3.3	3.38	60004.0	26P	90	25	-	-	2.8	2.1	-	3	004	●
M5X0.8	IS02(6H)	4.2	4.28	60005.0	25P	100	28	-	-	3.5	2.7	-	3	004	●
M6X1	IS02(6H)	5	5.09	60006.0	22P	110	32	-	-	4.5	3.4	-	3	004	●
M8X1.25	IS02(6H)	6.8	6.85	60008.0	23P	125	40	-	-	6	4.9	-	3	004	●
M10X1.5	IS02(6H)	8.5	8.6	6000010	22P	140	45	-	-	7	5.5	-	3	004	●

SPECIAL THREADS, GAUGES
DIN

- Intro
- SP
- SL
- PO
- ST
- ROLL
- CARBIDE
- LONG
- HAND TAPS
- EG (STI)
- THREAD MILLS
- DIES
- CENTER DRILLS
- Technical info

Intro

NT

GP General Purpose Series

SP

Nut Taps

SL



PO

Recommended Tapping Speeds Depending On Materials

ISO	Vc (m/min)	★	ISO	Vc (m/min)	★
P1	5÷10	★	M1	3÷7	★
P2	5÷10	★			
P7	3÷7	★			

★ 1st choice ☆ suitable

ST

ROLL

CARBIDE

LONG

HAND TAPS

EG (STI)

SPECIAL THREADS, GAUGES
JIS

THREAD MILLS

DIES

CENTER DRILLS

Technical info



FEATURES

Straight fluted tap for nut tapping machines.
Chamfer length 24P ÷ 30P

TYPE: ST_001

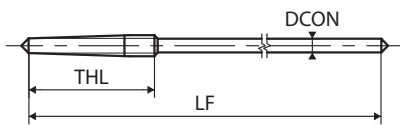

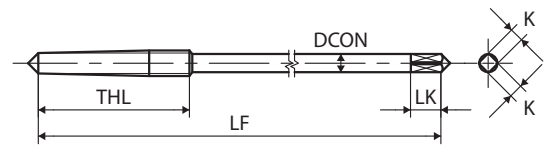

TYPE: ST_004

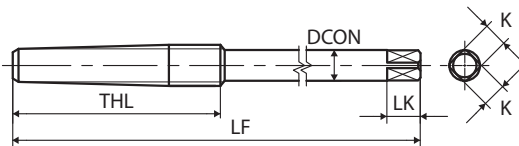

TYPE: ST_007



M	TCTR (tolerance)	 Hole Ø (mm)	Hole Ø (mm)	Code	THCHT (chamfer)	LF (mm)	THL (mm)	LU (mm)	LS (mm)	DCON (mm)	K (mm)	LK (mm)	NOF	Type	Stock
JIS															
M2X0.4	II b	1.6	1.65	NH22.0E	25P	75	14	-	-	1.4	-	-	3	001	○
M2.3X0.4	II b	1.9	1.95	NH22.3E	25P	80	14	-	-	1.7	-	-	3	001	○
M2.5X0.45	II b	2.1	2.11	NH22.5F	24P	85	15	-	-	2	-	-	3	001	○
M2.6X0.45	II b	2.2	2.21	NH22.6F	24P	85	15	-	-	2	-	-	3	001	○
3M0.6	II b	2.45	2.47	NH23.0H	25P	90	20	-	-	2.1	-	-	3	001	○
M3X0.5	II b	2.5	2.56	NH23.0G	30P	90	20	-	-	2.1	-	-	3	001	○
M3.5X0.6	II b	2.9	2.97	NH23.5H	25P	95	20	-	-	2.6	-	-	3	001	○
4M0.75	II b	3.3	3.33	NH24.0J	25P	100	25	-	-	2.8	-	-	3	001	○
M4X0.7	II b	3.3	3.38	NH24.0I	27P	100	25	-	-	2.8	-	-	3	001	○
M4.5X0.75	II b	3.8	3.83	NH24.5J	25P	105	25	-	-	3.3	2.5	5	3	004	○
5M0.9	II b	4.15	4.19	NH25.0L	24P	110	30	-	-	3.6	2.8	6	3	004	○
M5X0.8	II b	4.2	4.28	NH25.0K	24P	110	30	-	-	3.6	2.8	6	3	004	○
M5.5X0.9	II b	4.65	4.69	NH25.5L	24P	115	30	-	-	4.1	3.2	6	3	004	○
M6X1	II b	5	5.09	NH26.0M	26P	120	35	-	-	4.5	3.5	6	3	004	○
M7X1	II b	6	6.09	NH27.0M	26P	130	35	-	-	5.5	4.5	7	3	007	○
M8X1.25	II b	6.8	6.85	NH28.0N	24P	140	40	-	-	6.2	5	8	3	007	○
M9X1.25	II b	7.8	7.85	NH29.0N	27P	150	45	-	-	7.2	5.5	8	3	007	○
M10X1.5	II b	8.5	8.6	NH20100	25P	160	50	-	-	7.8	6	9	3	007	○
M12X1.75	II b	10.3	10.36	NH2012P	26P	170	60	-	-	9	7	10	3	007	○
M14X2	II b	12	12.12	NH2014Q	25P	190	65	-	-	11	9	12	3	007	○
M16X2	II b	14	14.12	NH2016Q	26P	200	70	-	-	13	10	13	3	007	○
M18X2.5	II b	15.5	15.63	NH2018R	24P	220	80	-	-	14	11	14	3	007	○
M20X2.5	II b	17.5	17.63	NH2020R	26P	230	85	-	-	16	12	15	3	007	○
M22X2.5	II b	19.5	19.63	NH2022R	27P	250	90	-	-	18	14	17	3	007	○
M24X3	II b	21	21.13	NH2024S	25P	260	100	-	-	19	15	18	3	007	○
M27X3	II b	24	24.13	NH2027S	27P	280	110	-	-	22	17	20	4	007	○
M30X3.5	II b	26.5	26.63	NH2030T	26P	300	120	-	-	24	19	22	4	007	○
M33X3.5	II b	29.5	29.63	NH2033T	26P	310	120	-	-	25	19	22	4	007	○
M36X4	II b	32	32.12	NH2036U	26P	330	140	-	-	28	21	24	4	007	○
M39X4	II b	35	35.12	NH2039U	26P	340	140	-	-	30	23	26	4	007	○
M42X4.5	II b	37.5	37.63	NH2042V	25P	360	150	-	-	32	26	30	4	007	○

MF	TCTR (tolerance)	 Hole Ø (mm)	Hole Ø (mm)	Code	THCHT (chamfer)	LF (mm)	THL (mm)	LU (mm)	LS (mm)	DCON (mm)	K (mm)	LK (mm)	NOF	Type	Stock
JIS															
M6X0.75	II	5.3	5.33	NH26.0J	24P	115	30	-	-	4.5	3.5	6	3	004	○
M8X1	II	7	7.09	NH28.0M	25P	130	40	-	-	6.2	5	8	3	007	○
M8X0.75	II	7.3	7.33	NH28.0J	24P	120	30	-	-	6.2	5	8	3	007	○
M9X1	II	8	8.09	NH29.0M	25P	140	40	-	-	7.2	5.5	8	3	007	○
M10X1.25	II	8.8	8.85	NH2010N	24P	150	45	-	-	7.8	6	9	3	007	○
M10X1	II	9	9.09	NH2010M	25P	140	40	-	-	7.8	6	9	3	007	○
M12X1.5	II	10.5	10.6	NH2012O	25P	160	55	-	-	9	7	10	3	007	○
M12X1.25	II	10.8	10.85	NH2012N	24P	160	45	-	-	9	7	10	3	007	○
M12X1	II	11	11.09	NH2012M	25P	150	40	-	-	9	7	10	3	007	○
M14X1.5	II	12.5	12.6	NH2014O	25P	170	55	-	-	11	9	12	3	007	○
M14X1.25	II	12.8	12.85	NH2014N	24P	170	50	-	-	11	9	12	3	007	○
M14X1	II	13	13.09	NH2014M	25P	160	40	-	-	11	9	12	3	007	○
M16X1.5	II	14.5	14.6	NH2016O	25P	180	55	-	-	13	10	13	3	007	○

Intro

SP

SL

PO

ST

ROLL

CARBIDE

LONG

HAND TAPS

EG (STI)

SPECIAL THREADS, GAUGES JIS

THREAD MILLS

DIES

CENTER DRILLS

Technical info

Special Threads, Gauges

Intro

MF	TCTR (tolerance)	 Hole Ø (mm)	Hole Ø (mm)	Code	THCHT (chamfer)	LF (mm)	THL (mm)	LU (mm)	LS (mm)	DCON (mm)	K (mm)	LK (mm)	NOF	Type	Stock	
JIS																
SP	M16X1	II	15	15.09	NH2016M	25P	170	40	-	-	13	10	13	3	007	○
	M18X2	II	16	16.12	NH2018Q	25P	210	75	-	-	14	11	14	3	007	○
	M18X1.5	II	16.5	16.6	NH20180	25P	190	55	-	-	14	11	14	3	007	○
SL	M18X1	II	17	17.09	NH2018M	25P	180	45	-	-	14	11	14	3	007	○
	M20X2	II	18	18.12	NH2020Q	25P	220	75	-	-	16	12	15	3	007	○
	M20X1.5	II	18.5	18.6	NH20200	25P	200	60	-	-	16	12	15	3	007	○
PO	M20X1	II	19	19.09	NH2020M	25P	190	45	-	-	16	12	15	3	007	○
	M22X1.5	II	20.5	20.6	NH20220	25P	210	60	-	-	18	14	17	3	007	○
	M24X2	II	22	22.12	NH2024Q	25P	240	75	-	-	19	15	18	3	007	○
ST	M24X1.5	II	22.5	22.6	NH20240	25P	220	60	-	-	19	15	18	3	007	○
	M25X2	II	23	23.12	NH2025Q	25P	240	75	-	-	20	15	18	3	007	○
	M25X1.5	II	23.5	23.6	NH20250	25P	220	60	-	-	20	15	18	3	007	○
ROLL	M26X1.5	II	24.5	24.6	NH20260	25P	230	60	-	-	20	15	18	3	007	○
	M27X2	II	25	25.12	NH2027Q	25P	250	75	-	-	22	17	20	4	007	○
	M27X1.5	II	25.5	25.6	NH20270	25P	230	60	-	-	22	17	20	4	007	○
CARBIDE	M28X1.5	II	26.5	26.6	NH20280	25P	240	60	-	-	22	17	20	4	007	○
	M30X2	II	28	28.12	NH2030Q	25P	260	75	-	-	24	19	22	4	007	○
	M30X1.5	II	28.5	28.6	NH20300	25P	240	60	-	-	24	19	22	4	007	○

CARBIDE

BSW	TCTR (tolerance)	 Hole Ø (mm)	Hole Ø (mm)	Code	THCHT (chamfer)	LF (mm)	THL (mm)	LU (mm)	LS (mm)	DCON (mm)	K (mm)	LK (mm)	NOF	Type	Stock	
JIS																
LONG	1/8W40	II b	2.55	2.56	NH2W02H	28P	95	25	-	-	2.2	-	-	3	001	○
	3/16W24	II b	3.7	3.7	NH2W03M	25P	110	35	-	-	3.2	2.5	5	3	004	○
	1/4W20	II b	5.1	5.13	NH2W04N	24P	125	42	-	-	4.5	3.5	6	3	004	○
HAND TAPS	5/16W18	II b	6.5	6.59	NH2W050	27P	140	50	-	-	5.9	4.5	7	3	007	○
	3/8W16	II b	8	8.02	NH2W06P	26P	155	55	-	-	7.3	5.5	8	3	007	○
	7/16W14	II b	9.3	9.39	NH2W07Q	25P	165	60	-	-	8.5	6.5	9	3	007	○
EG (STI)	1/2W12	II b	10.6	10.7	NH2W08S	23P	180	65	-	-	9.5	7	10	3	007	○
	9/16W12	II b	12.25	12.29	NH2W09S	25P	190	70	-	-	11	9	12	3	007	○
	5/8W11	II b	13.5	13.68	NH2W10U	24P	200	75	-	-	12.5	10	13	3	007	○
SPECIAL THREADS, GAUGES	3/4W10	II b	16.5	16.63	NH2W12V	25P	230	85	-	-	15	12	15	3	007	○
	7/8W9	II b	19.5	19.53	NH2W14W	25P	250	95	-	-	18	14	17	3	007	○
	1 W8	II b	22.2	22.34	NH2W16X	25P	270	105	-	-	20.5	17	20	3	007	○
JIS	1 1/8W7	II b	24.75	25.04	NH2W18Y	25P	290	120	-	-	23	17	20	4	007	○
	1 1/4W7	II b	28	28.21	NH2W20Y	26P	300	125	-	-	26	21	24	4	007	○
	1 3/8W6	II b	30.5	30.72	NH2W22Z	24P	320	135	-	-	28	21	24	4	007	○
THREAD MILLS	1 1/2W6	II b	33.75	33.9	NH2W24Z	25P	330	140	-	-	31	23	26	4	007	○

THREAD MILLS

DIES

CENTER DRILLS

Technical info

MS+TR

GP General Purpose Series

Straight Fluted Taps for Miniature Threads



FEATURES

Cutting tap for miniature threads

Recommended Tapping Speeds Depending On Materials

ISO	Vc (m/min)
N1	≤5 ★
N2	≤5 ★
N3	≤5 ☆
N4	≤5 ★

★ 1st choice ☆ suitable

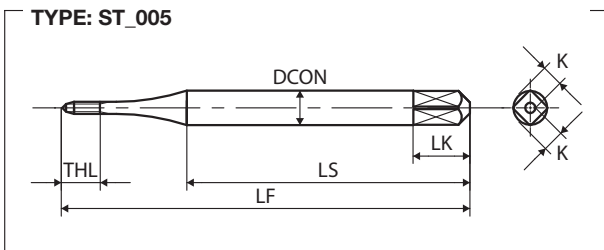

S Miniature	TCTR (tolerance)	∅ (mm)	Hole ∅ (mm)	Code	THCHT (chamfer)	LF (mm)	THL (mm)	LU (mm)	LS (mm)	DCON (mm)	K (mm)	LK (mm)	NOF	Type	Stock
JIS															
S0.4X0.1	-	0.31	0.32	GMHRP0.4-3	3P	36	1.5	-	26	3	2.5	6	3	005	○
S0.5X0.125	-	0.4	0.41	GMHRP0.5-3	3P	36	2	-	26	3	2.5	6	3	005	○
S0.6X0.15	-	0.48	0.49	GMHRP0.6-3	3P	36	2.5	-	25	3	2.5	6	3	005	○
S0.7X0.175	-	0.56	0.57	GMHRP0.7-3	3P	36	2.5	-	25	3	2.5	6	3	005	○
S0.8X0.2	-	0.64	0.65	GMHRP0.8-3	3P	36	3	-	25	3	2.5	6	3	005	○
S0.9X0.225	-	0.72	0.73	GMHRP0.9-3	3P	36	3	-	25	3	2.5	6	3	005	○

SPECIAL THREADS, GAUGES
JIS

THREAD MILLS

DIES

CENTER DRILLS

Technical info

Intro

SP

SL

PO

ST

ROLL

CARBIDE

LONG

HAND TAPS

EG (STI)

THREAD MILLS

DIES

CENTER DRILLS

Technical info

Intro

MS+RS

GP General Purpose Series

Roll Taps for Miniature Threads



SP

SL



PO

Recommended Tapping Speeds Depending On Materials

ISO	Vc (m/min)	
N1	≤10	★
N2	≤10	★
N3	≤10	★

★ 1st choice ☆ suitable

ST

ROLL

CARBIDE

LONG

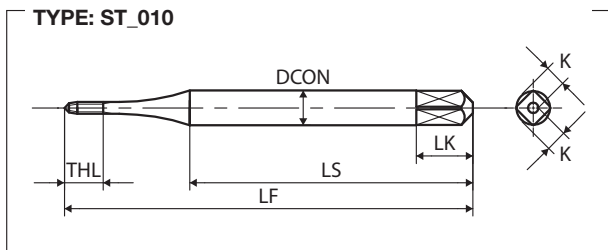

HAND TAPS

EG (STI)

SPECIAL THREADS, GAUGES

JIS

THREAD MILLS

DIES

CENTER DRILLS

Technical info

FEATURES

Forming tap for miniature thread sizes.
 Specific design and high precision blanks to improve rigidity, bending strength and run-out tolerance.
 For non-ferrous materials.

S Miniature	TCTR (tolerance)	Bored Hole Ø (mm)		Code	THCHT (chamfer)	LF (mm)	THL (mm)	LU (mm)	LS (mm)	DCON (mm)	K (mm)	LK (mm)	NOF (Lobes)	Type	Stock
		Max	Min												
JIS															
S0.6X0.15	GS2	0.55	0.54	MSP20.6-B	2P	36	2.5	-	25	3	2.5	6	0(4)	010	○
S0.7X0.175	GS3	0.64	0.62	MSP30.7-B	2P	36	2.5	-	25	3	2.5	6	0(4)	010	○
S0.8X0.2	GS3	0.73	0.71	MSP30.8-B	2P	36	3	-	25	3	2.5	6	0(4)	010	○
S0.9X0.225	GS4	0.82	0.8	MSP40.9-B	2P	36	3	-	25	3	2.5	6	0(4)	010	○

HPsRZ

MP Multi Purpose Series

High Performance Roll Taps for Miniature Threads, Coated



FEATURES

Forming tap for miniature thread sizes.
Specific design and high precision blanks to improve rigidity, bending strength and run-out tolerance.
For steel, stainless steel and stainless steel application.

Recommended Tapping Speeds Depending On Materials

ISO	Vc (m/min)	ISO	Vc (m/min)	ISO	Vc (m/min)
P1	15÷30 ★	M1	10÷25 ★	N1	10÷45 ☆
P2	15÷30 ★	M2	10÷25 ★	N2	10÷45 ☆
P3	15÷25 ★				
P4	15÷25 ★				
P7	10÷25 ★				

★ 1st choice ☆ suitable

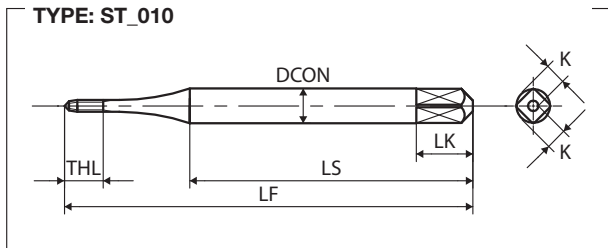

S Miniature	TCTR (tolerance)	Bored Hole Ø (mm)		Code	THCHT (chamfer)	LF (mm)	THL (mm)	LU (mm)	LS (mm)	DCON (mm)	K (mm)	LK (mm)	NOF (Lobes)	Type	Stock
		Max	Min												
JIS															
S0.6X0.15	GS2	0.55	0.54	HPS20.6-B	2P	36	2.5	-	25	3	2.5	6	0(4)	010	○
S0.7X0.175	GS3	0.64	0.62	HPS30.7-B	2P	36	2.5	-	25	3	2.5	6	0(4)	010	○
S0.8X0.2	GS3	0.73	0.71	HPS30.8-B	2P	36	3	-	25	3	2.5	6	0(4)	010	○
S0.9X0.225	GS4	0.82	0.8	HPS40.9-B	2P	36	3	-	25	3	2.5	6	0(4)	010	○

- Intro
- SP
- SL
- PO
- ST
- ROLL
- CARBIDE
- LONG
- HAND TAPS
- EG (STI)
- SPECIAL THREADS, GAUGES JIS
- THREAD MILLS
- DIES
- CENTER DRILLS
- Technical info

Intro

SL Tr

GP General Purpose Series

SP Left Spiral Fluted Taps for Trapezoidal Threads



SP

SL



PO

Recommended Tapping Speeds Depending On Materials

ISO Vc (m/min)

P1 ≤5 ★

P2 ≤5 ★

ST

★ 1st choice ☆ suitable

ROLL

CARBIDE

LONG

HAND TAPS

EG (STI)

SPECIAL THREADS, GAUGES

JIS

THREAD MILLS

DIES

CENTER DRILLS

Technical info

FEATURES

Spiral fluted tap for through hole trapezoidal threads.

The thread angle is 30°.

Thread symbol is Tr.

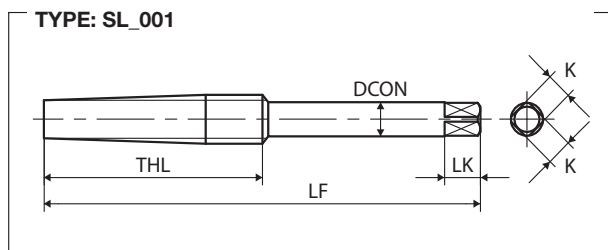

Tr	$\frac{D}{mm}$	Hole \varnothing (mm)	Code	THCHT (chamfer)	LF (mm)	THL (mm)	DCON (mm)	K (mm)	LK (mm)	NOF	Type	Stock
JIS												
TR10X2	8.1	8.18	LYT10Q0HEB	26P	160	70	7.8	6	9	3	001	○
TR12X3	9.2	9.24	LYT12S0HEB	23P	190	95	9	7	10	3	001	○
TR12X2	10.1	10.18	LYT12Q0HEB	30P	170	80	9	7	10	3	001	○
TR14X3	11.2	11.24	LYT14S0HEB	23P	190	95	11	9	12	3	001	○
TR16X4	12.25	12.28	LYT16U0HEB	22.5P	220	120	12	9	12	3	001	○
TR16X3	13.2	13.24	LYT16S0HEB	25P	200	100	13	10	13	3	001	○
TR18X4	14.25	14.28	LYT18U0HEB	22.5P	220	120	14	11	14	4	001	○
TR20X4	16.25	16.28	LYT20U0HEB	24.5P	230	130	16	12	15	4	001	○
TR22X5	17.3	17.34	LYT22W0HEB	22P	250	150	18	14	17	4	001	○
TR24X5	19.3	19.34	LYT24W0HEB	24P	260	160	19	15	18	4	001	○
TR25X5	20.3	20.34	LYT25W0HEB	25P	270	170	20	15	18	4	001	○
TR26X5	21.3	21.34	LYT26W0HEB	27P	280	180	21	17	20	4	001	○
TR28X5	23.3	23.34	LYT28W0HEB	28P	290	190	22	17	20	4	001	○
TR30X6	24.3	24.38	LYT30Y0HEB	25P	300	200	24	19	22	4	001	○

SL LH Tr

GP General Purpose Series

Left Spiral Fluted Taps for Trapezoidal Left Hand Threads



Intro

SP

SL

PO

ST

ROLL

CARBIDE

LONG

HAND TAPS

EG (STI)

SPECIAL THREADS, GAUGES
JIS

THREAD MILLS

DIES

CENTER DRILLS

Technical info



FEATURES

Spiral fluted tap for through hole left hand trapezoidal threads.

The thread angle is 30°.

Thread symbol is Tr.

Recommended Tapping Speeds Depending On Materials

ISO Vc (m/min)

P1	≤5	★
P2	≤5	★

★ 1st choice ☆ suitable

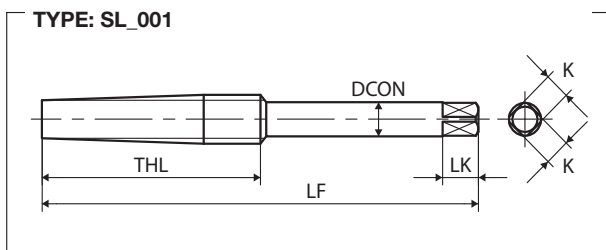

Tr	Hole Ø (mm)	Hole Ø (mm)	Code	THCHT (chamfer)	LF (mm)	THL (mm)	DCON (mm)	K (mm)	LK (mm)	NOF	Type	Stock
JIS												
TR10X2	8.1	8.18	ZYT10Q0HEB	26P	160	70	7.8	6	9	3	001	○
TR12X3	9.2	9.24	ZYT12S0HEB	23P	190	95	9	7	10	3	001	○
TR12X2	10.1	10.18	ZYT12Q0HEB	30P	170	80	9	7	10	3	001	○
TR14X3	11.2	11.24	ZYT14S0HEB	23P	190	95	11	9	12	3	001	○
TR16X4	12.25	12.28	ZYT16U0HEB	22.5P	220	120	12	9	12	3	001	○
TR16X3	13.2	13.24	ZYT16S0HEB	25P	200	100	13	10	13	3	001	○
TR18X4	14.25	14.28	ZYT18U0HEB	22.5P	220	120	14	11	14	4	001	○
TR20X4	16.25	16.28	ZYT20U0HEB	24.5P	230	130	16	12	15	4	001	○
TR22X5	17.3	17.34	ZYT22W0HEB	22P	250	150	18	14	17	4	001	○
TR24X5	19.3	19.34	ZYT24W0HEB	24P	260	160	19	15	18	4	001	○
TR25X5	20.3	20.34	ZYT25W0HEB	25P	270	170	20	15	18	4	001	○
TR26X5	21.3	21.34	ZYT26W0HEB	27P	280	180	21	17	20	4	001	○
TR28X5	23.3	23.34	ZYT28W0HEB	28P	290	190	22	17	20	4	001	○
TR30X6	24.3	24.38	ZYT30Y0HEB	25P	300	200	24	19	22	4	001	○

Intro

SP TRI

GP General Purpose Series

Spiral Fluted Taps for Tripod Threads



SP

SL



PO

Recommended Tapping Speeds Depending On Materials

ISO	Vc (m/min)
N1	≤10 ★
N2	≤10 ★
N3	≤10 ★
N4	≤10 ★

★ 1st choice ☆ suitable

ST

ROLL

CARBIDE

LONG

HAND TAPS

EG (STI)

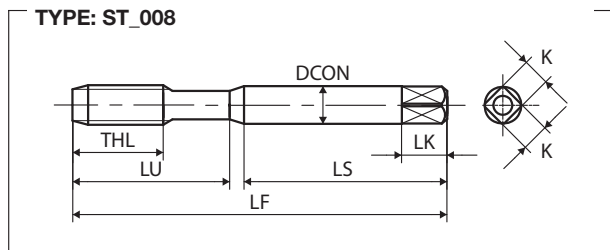

FEATURES

For camera tripod threads.
Thread is oversized.

TRI	TCTR (tolerance)	(mm)	Hole Ø (mm)	Code	THCHT (chamfer)	LF (mm)	THL (mm)	LU (mm)	LS (mm)	DCON (mm)	K (mm)	LK (mm)	NOF	Type	Stock
JIS															
1/4-20	-	5.15	5.19	SYU04NOKEB	2.5P	62	15	26	33	6	4.5	7	3	008	○

SPECIAL THREADS, GAUGES
JIS

THREAD MILLS

DIES

CENTER DRILLS

Technical info

HT TRI

GP General Purpose Series

Straight Fluted Taps for Tripod Threads



Recommended Tapping Speeds Depending On Materials

ISO	Vc (m/min)
N1	≤10 ★
N2	≤10 ★
N3	≤10 ★
N4	≤10 ★

★ 1st choice ☆ suitable

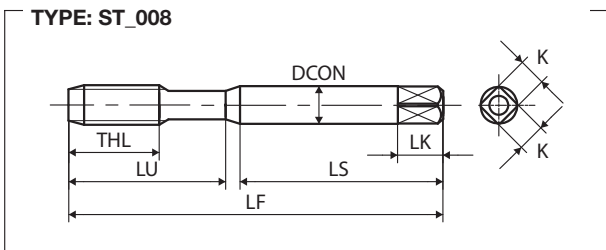

TRI	TCTR (tolerance)	Hole Ø (mm)	Hole Ø (mm)	Code	THCHT (chamfer)	LF (mm)	THL (mm)	LU (mm)	LS (mm)	DCON (mm)	K (mm)	LK (mm)	NOF	Type	Stock
JIS															
1/4-20	-	5.15	5.19	TYU04N0KEB3	3P	62	15	26	33	6	4.5	7	3	008	○
	-	5.15	5.19	TYU04N0KEBA	1.5P	62	15	26	33	6	4.5	7	3	008	○



FEATURES

For camera tripod threads.
Thread is oversized.

Intro

SP

SL

PO

ST

ROLL

CARBIDE

LONG

HAND TAPS

EG (STI)

SPECIAL THREADS, GAUGES
JIS

THREAD MILLS

DIES

CENTER DRILLS

Technical info

Intro

RLS-HT

GP General Purpose Series

Straight Fluted Taps for Camera Release Threads



SP

SL



PO

Recommended Tapping Speeds Depending On Materials

ISO Vc (m/min)

N4 ≤1 ★

★ 1st choice ☆ suitable

ST

ROLL

CARBIDE

LONG

HAND TAPS

EG (STI)

SPECIAL THREADS, GAUGES

JIS

THREAD MILLS

DIES

CENTER DRILLS

Technical info

FEATURES

For special threads for installing camera release.

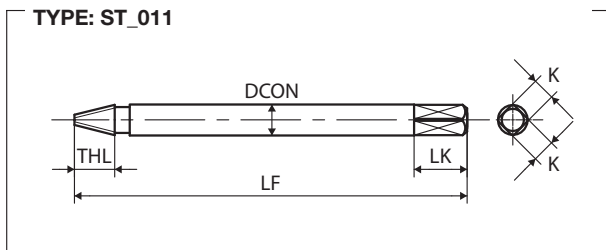

RLS	TCTR (tolerance)	Hole Ø (mm)	Hole Ø (mm)	Code	THCHT (chamfer)	LF (mm)	THL (mm)	LU (mm)	LS (mm)	DCON (mm)	K (mm)	LK (mm)	NOF	Type	Stock
JIS															
3.4X0.5X28°	-			TY3.4G0LEB	-	52	5.25	-	-	4	3.2	6	3	011	○

HT TV

GP General Purpose Series

Straight fluted Taps for Automobile Tire Valve Threads



FEATURES

For automobile tire valves.

Recommended Tapping Speeds Depending On Materials

ISO Vc (m/min)

N4 ≤10 ★

★ 1st choice ☆ suitable

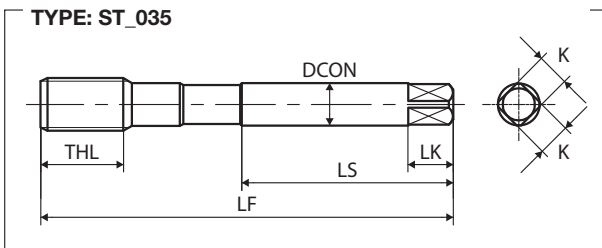
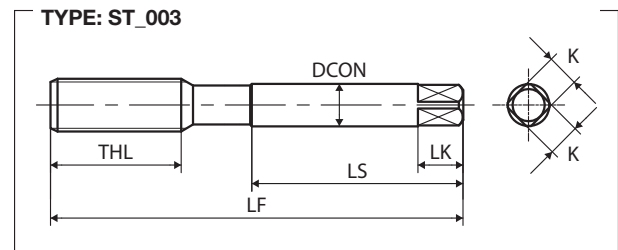
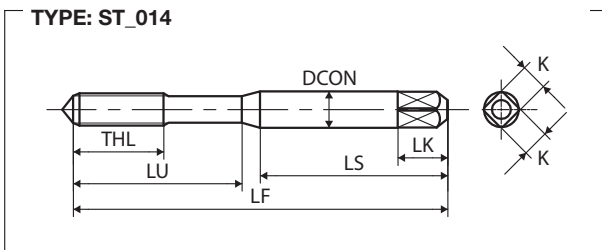

V	TCTR (tolerance)	Hole Ø (mm)	Hole Ø (mm)	Code	THCHT (chamfer)	LF (mm)	THL (mm)	LU (mm)	LS (mm)	DCON (mm)	K (mm)	LK (mm)	NOF	Type	Stock
JIS															
5V1	P3	4.7	4.75	TY05V1RLEBA	1.5P	62	15	26	33	6	4.5	7	3	014	○
8V2	P2	6.9	6.97	TY08V2QLEBA	1.5P	70	19	-	36	6.2	5	8	3	003	○
8V1	P4	7.15	7.19	TY08V1SLEBA	1.5P	70	19	-	36	6.2	5	8	3	003	○
9V1	P2	8.8	8.81	TY09V1QLEBA	1.5P	75	23	-	38	7	5.5	8	4	003	○
10V1	P2	8.8	8.86	TY10V1QLEBA	1.5P	75	23	-	38	7	5.5	8	4	003	○
10V2	P3	9.5	9.5	TY10V2RLEBA	1.5P	82	26	-	42	8.5	6.5	9	4	003	○
11V1	P3	9.9	9.96	TY11V1RLEBA	1.5P	82	26	-	42	8.5	6.5	9	4	003	○
12V1	P3	11.3	11.33	TY12V1RLEBA	1.5P	88	26	-	45	10.5	8	11	4	003	○
13V1	P3	11.5	11.54	TY13V1RLEBA	1.5P	88	26	-	45	10.5	8	11	4	003	○
13V2	P2	11.9	11.99	TY13V2QLEBA	1.5P	88	26	-	45	10.5	8	11	4	003	○

- Intro
- SP
- SL
- PO
- ST
- ROLL
- CARBIDE
- LONG
- HAND TAPS
- EG (STI)
- SPECIAL THREADS, GAUGES JIS
- THREAD MILLS
- DIES
- CENTER DRILLS
- Technical info

Intro

V	TCTR (tolerance)	 Hole Ø (mm)	Hole Ø (mm)	Code	THCHT (chamfer)	LF (mm)	THL (mm)	LU (mm)	LS (mm)	DCON (mm)	K (mm)	LK (mm)	NOF	Type	Stock
JIS															
15V1	P2	13.9	13.9	TY15V1QLEBA	1.5P	95	26	-	48	12.5	10	13	4	003	○
16V1	P3	15	15.03	TY16V1RLEBA	1.5P	95	26	-	48	12.5	10	13	4	003	○
17V1	P2	15.9	15.9	TY17V1QLEBA	1.5P	100	18	-	51	14	11	14	4	035	○
17V3	P3	16	16.01	TY17V3RLEBA	1.5P	100	33	-	51	14	11	14	4	003	○
17V2	P3	16.5	16.5	TY17V2RLEBA	1.5P	100	18	-	51	14	11	14	4	035	○
19V1	P3	17.5	17.59	TY19V1RLEBA	1.5P	105	33	-	50	15	12	15	4	003	○
20V1	P2	19.4	19.4	TY20V1QLEBA	1.5P	115	19	-	55	17	13	16	4	035	○

PO

ST

ROLL

CARBIDE

LONG

HAND
TAPS

EG (STI)

SPECIAL
THREADS,
GAUGES

JIS

THREAD
MILLS

DIES

CENTER
DRILLS

Technical
info

HT CTV

GP General Purpose Series

Straight fluted Taps for Bicycle Tire Valve Threads



FEATURES

For bicycle tire valves.

Recommended Tapping Speeds Depending On Materials

ISO Vc (m/min)

N4 ≤10 ★

★ 1st choice ☆ suitable

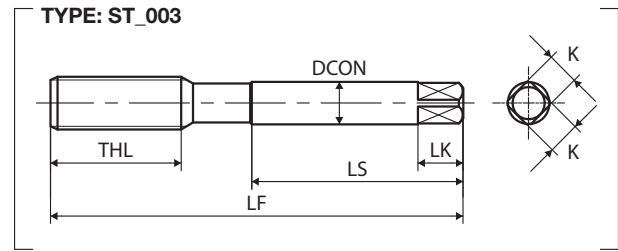
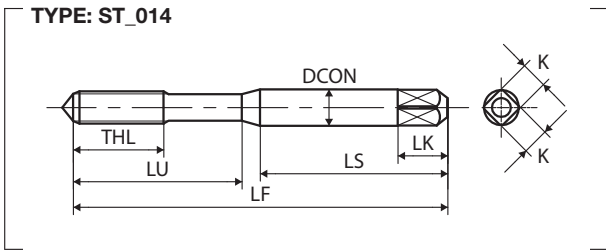

CTV	TCTR (tolerance)	Hole Ø (mm)	Hole Ø (mm)	Code	THCHT (chamfer)	LF (mm)	LT (mm)	THL (mm)	LU (mm)	LS (mm)	DCON (mm)	K (mm)	LK (mm)	NOF	Type	Stock
JIS																
CTV5-24	P4	4.1	4.15	TYCV5MSLEBA	1.5P	62	-	15	26	33	6	4.5	7	3	014	○
5V2	P2	4.5	4.55	TY05V2QLEBA	1.5P	62	-	15	26	33	6	4.5	7	3	014	○
CTV5-36	P3	4.7	4.71	TYCV5IRLEBA	1.5P	62	-	15	26	33	6	4.5	7	3	014	○
6V1	P2	5.5	5.52	TY06V1QLEBA	1.5P	62	-	15	26	33	6	4.5	7	3	014	○
CTV8-32	P3	7.1	7.15	TYCV8JRLEBA	1.5P	70	-	18	-	36	6.2	5	8	3	003	○
CTV8-30	P3	7.25	7.3	TYCV83RLEBA	1.5P	75	-	23	-	38	7	5.5	8	3	003	○

- Intro
- SP
- SL
- PO
- ST
- ROLL
- CARBIDE
- LONG
- HAND TAPS
- EG (STI)
- SPECIAL THREADS, GAUGES JIS
- THREAD MILLS
- DIES
- CENTER DRILLS
- Technical info

Intro

HT BC

GP General Purpose Series

Straight Fluted Taps for Bicycle Threads



SP

SL



PO

Recommended Tapping Speeds Depending On Materials

ISO Vc (m/min)

P1 ≤10 ★

P2 ≤10 ★

ST

★ 1st choice ☆ suitable

ROLL

CARBIDE

LONG

HAND TAPS

EG (STI)

SPECIAL THREADS, GAUGES

JIS

THREAD MILLS

DIES

CENTER DRILLS

Technical info

FEATURES

General purpose for bicycle threads

TYPE: ST_012

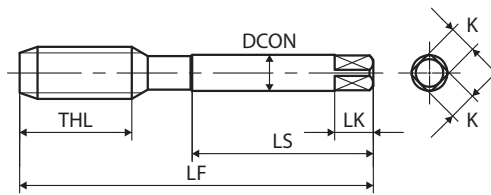

BC	TCTR (tolerance)	 Hole Ø (mm)	Hole Ø (mm)	Code	THCHT (chamfer)	LF (mm)	LT (mm)	THL (mm)	LU (mm)	LS (mm)	DCON (mm)	K (mm)	LK (mm)	NOF	Type	Stock
JIS																
BC 5/16-26	P3	7.1	7.13	TYBC01RHEB5	5P	70	-	19	-	36	6.2	5	8	3	012	○
	P3	7.1	7.13	TYBC01RHEBA	1.5P	70	-	19	-	36	6.2	5	8	3	012	○
BC 3/8-26	P3	8.7	8.73	TYBC02RHEB5	5P	75	-	23	-	38	7	5.5	8	4	012	○
	P3	8.7	8.73	TYBC02RHEBA	1.5P	75	-	23	-	38	7	5.5	8	4	012	○
BC 7/16-26	P3	10.3	10.31	TYBC03RHEB5	5P	82	-	26	-	42	8.5	6.5	9	4	012	○
	P3	10.3	10.31	TYBC03RHEBA	1.5P	82	-	26	-	42	8.5	6.5	9	4	012	○
BC 1/2-20	P3	11.6	11.63	TYBC04RHEB5	5P	88	-	26	-	45	10.5	8	11	4	012	○
	P3	11.6	11.63	TYBC04RHEBA	1.5P	88	-	26	-	45	10.5	8	11	4	012	○
BC 9/16-20	P3	13.2	13.23	TYBC05RHEB5	5P	95	-	26	-	48	12.5	10	13	4	012	○
	P3	13.2	13.23	TYBC05RHEBA	1.5P	95	-	26	-	48	12.5	10	13	4	012	○
BC 5/8-20	P3	14.75	14.81	TYBC06RHEB5	5P	95	-	26	-	48	12.5	10	13	4	012	○
	P3	14.75	14.81	TYBC06RHEBA	1.5P	95	-	26	-	48	12.5	10	13	4	012	○
BC 11/16-24	P3	16.5	16.57	TYBC07RHEB5	5P	100	-	18	-	51	14	11	14	4	012	○
	P3	16.5	16.57	TYBC07RHEBA	1.5P	100	-	18	-	51	14	11	14	4	012	○
BC 3/4-30	P3	18.3	18.37	TYBC08RHEB5	5P	105	-	18	-	50	15	12	15	4	012	○
	P3	18.3	18.37	TYBC08RHEBA	1.5P	105	-	18	-	50	15	12	15	4	012	○
BC 31/32-30	P3	23.9	23.94	TYBC09RHEB5	5P	125	-	20	-	58	19	15	18	4	012	○
	P3	23.9	23.94	TYBC09RHEBA	1.5P	125	-	20	-	58	19	15	18	4	012	○
BC 1-24	P3	24.5	24.53	TYBC10RHEB5	5P	125	-	20	-	58	19	15	18	4	012	○
	P3	24.5	24.53	TYBC10RHEBA	1.5P	125	-	20	-	58	19	15	18	4	012	○
BC 1.29-24	P3	31.9	31.92	TYBC11RHEB5	5P	145	-	21	-	67	25	19	22	4	012	○
	P3	31.9	31.92	TYBC11RHEBA	1.5P	145	-	21	-	67	25	19	22	4	012	○
BC 1.37-24	P3	33.9	33.95	TYBC12RHEB5	5P	155	-	26	-	71	28	21	24	4	012	○
	P3	33.9	33.95	TYBC12RHEBA	1.5P	155	-	26	-	71	28	21	24	4	012	○
BC 1 7/16-24	P3	35.6	35.66	TYBC13RHEB5	5P	165	-	26	-	76	30	23	26	4	012	○
	P3	35.6	35.66	TYBC13RHEBA	1.5P	165	-	26	-	76	30	23	26	4	012	○
BC 1.45-24	P3	35.9	35.98	TYBC14RHEB5	5P	165	-	26	-	76	30	23	26	4	012	○
	P3	35.9	35.98	TYBC14RHEBA	1.5P	165	-	26	-	76	30	23	26	4	012	○
BC 1 9/16-24	P3	38.8	38.84	TYBC15RHEB5	5P	175	-	27	-	81	32	26	30	4	012	○
	P3	38.8	38.84	TYBC15RHEBA	1.5P	175	-	27	-	81	32	26	30	4	012	○

Intro

SP

SL

PO

ST

ROLL

CARBIDE

LONG

HAND
TAPS

EG (STI)

SPECIAL
THREADS,
GAUGES
JISTHREAD
MILLS

DIES

CENTER
DRILLSTechnical
info

Intro

HT CTC

GP General Purpose Series

Straight Fluted Taps for Metal Thin-Walled Conduit Threads



SP

SL



PO

Recommended Tapping Speeds Depending On Materials

ISO Vc (m/min)

P1 ≤10 ★

P2 ≤10 ★

ST

★ 1st choice ☆ suitable

ROLL

CARBIDE

LONG

HAND TAPS

EG (STI)

SPECIAL THREADS, GAUGES

JIS

THREAD MILLS

DIES

CENTER DRILLS

Technical info

FEATURES

For steel conduit threads.
Thread angle is 80°.
Thread symbol is CTC.

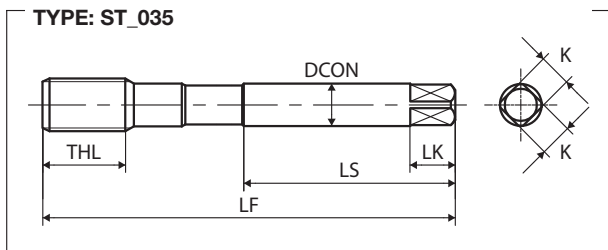

CTC	TCTR (tolerance)	\varnothing (mm)	Hole \varnothing (mm)	Code	THCHT (chamfer)	LF (mm)	LT (mm)	THL (mm)	LU (mm)	LS (mm)	DCON (mm)	K (mm)	LK (mm)	NOF	Type	Stock
JIS																
CTC19-16	-	18	18.11	TYCC190HEB5	5P	105	-	23	-	50	15	12	15	4	035	○
CTC25-16	-	24.3	24.41	TYCC250HEB5	5P	125	-	24	-	58	19	15	18	4	035	○
CTC31-16	-	30.75	30.81	TYCC310HEB5	5P	145	-	26	-	67	24	19	22	4	035	○
CTC39-16	-	37	37.11	TYCC390HEB5	5P	165	-	27	-	76	30	23	26	4	035	○

HT CTG

GP General Purpose Series

Straight Fluted Taps for Metal Thick-Walled Conduit Threads



Intro

SP

SL

PO

ST

ROLL

CARBIDE

LONG

HAND TAPS

EG (STI)

SPECIAL THREADS, GAUGES
JIS

THREAD MILLS

DIES

CENTER DRILLS

Technical info



Recommended Tapping Speeds Depending On Materials

ISO Vc (m/min)

P1 ≤10 ★

P2 ≤10 ★

★ 1st choice ☆ suitable

FEATURES

For thick steel conduit threads.

Thread angle is 55°.

Thread symbol is CTG.

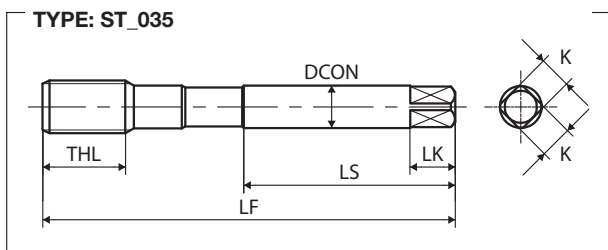

CTG	TCTR (tolerance)	∅ (mm)	Hole ∅ (mm)	Code	THCHT (chamfer)	LF (mm)	LT (mm)	THL (mm)	LU (mm)	LS (mm)	DCON (mm)	K (mm)	LK (mm)	NOF	Type	Stock
JIS																
CTG16-14	-	19.3	19.4	TYCG160HEB5	5P	115	-	25	-	55	17	13	16	4	035	○
CTG22-14	-	24.8	24.88	TYCG220HEB5	5P	130	-	26	-	60	20	15	18	4	035	○
CTG28-11	-	31.2	31.21	TYCG280HEB5	5P	155	-	31	-	71	28	21	24	4	035	○
CTG36-11	-	39.8	39.87	TYCG360HEB5	5P	180	-	33	-	83	35	26	30	4	035	○
CTG42-11	-	45.7	45.77	TYCG420HEB5	5P	185	-	34	-	85	38	29	32	4	035	○

Intro

SIT

Inspection Tools

Simple Thread Inspection Tools

SP

SL

HSS

PO

ST

ROLL

CARBIDE

LONG

HAND TAPS

EG (STI)

SPECIAL THREADS, GAUGES, YMW

THREAD MILLS

DIES

CENTER DRILLS

Technical info



FEATURES

HSS material increases considerably the gauge life.

Product Features

- SIT can minimize the inspection process time and improve the inspection efficiency by adopting step screw thread.
- Premium HSS material extends the tool life dramatically.
- Tool for through hole or blind hole is available individually.
- Color case and color mark on the tool simplify tool storage control.

-What is the step screw thread?

-YAMAWA new thread gauge (for through hole) features a step screw thread on its end allowing the gauge to enter easily the internal screw and work efficiently particularly when checking fine pitches screw threads.

Note : Step screw thread is not applied to the gauge for blind hole (NP gauge)

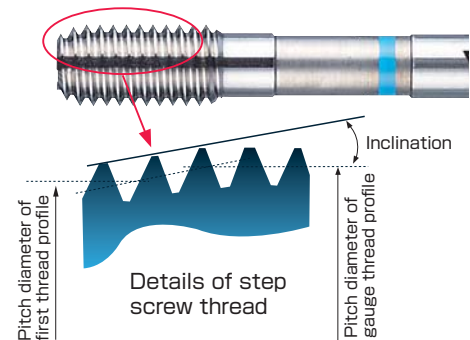

Accuracy of SIT

Simple pitch diameter tolerance, pitch tolerance and thread half angle tolerance, are 3 important factors on measuring internal screw threads. For SIT and thread plug gauge these values are the same.

Comparison between GB-6H/and GP-6H/thread plug gauge

Size	OD				PD				Pitch tolerance (±)	Tolerance for thread half angle (±minute)
	Basic size	Max	Min	Tol.	Basic size	Max	Min	Tol.		
GB-6H M6×1	6.000	6.023	6.001	0.022	5.350	5.3675	5.3565	0.011	0.005	15
GP-6H M6×1	6.000	6.023	6.001	0.022	5.350	5.3675	5.3565	0.011	0.005	15

The pitch diameter is simple pitch diameter. Pitch tolerance includes error of thread lead.

Comparison between NB-6H/and NP-6H/thread plug gauge

Size	OD				PD				Pitch tolerance (±)	Tolerance for thread half angle (±minute)
	Basic size	Max	Min	Tol.	Basic size	Max	Min	Tol.		
NB-6H M6×1	5.7055	5.7165	5.6945	0.022	5.500	5.511	5.500	0.011	0.005	16
NP-6H M6×1	5.7055	5.7165	5.6945	0.022	5.500	5.511	5.500	0.011	0.005	16

Main specification of SIT is same with that of thread gauge. But SIT has partly Yamawa's own design in the length of thread and bottom part relief. Due to these features, Yamawa has adopted the name "Simple Inspection Tool or SIT" instead of using the name "thread gauge".

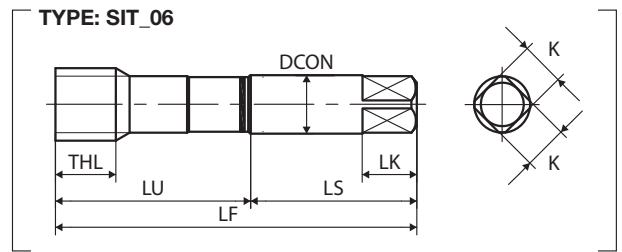
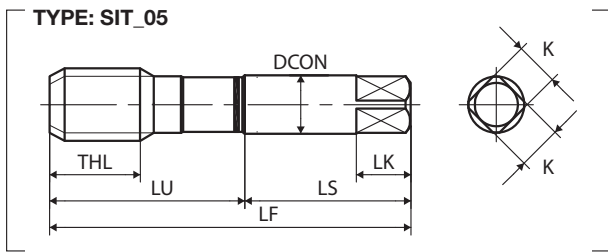
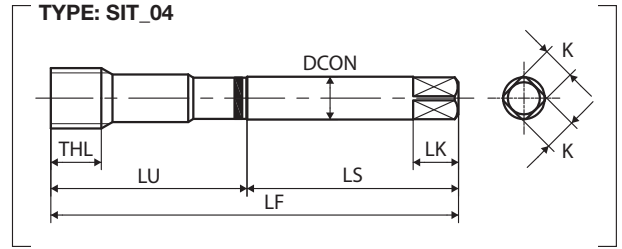
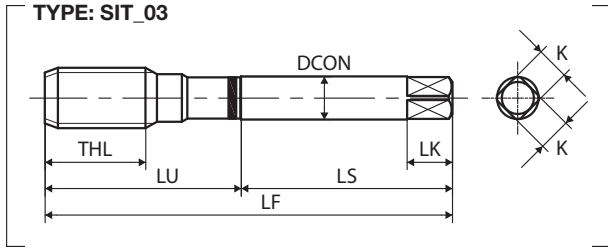
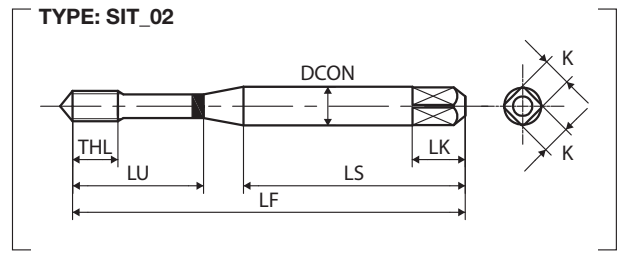
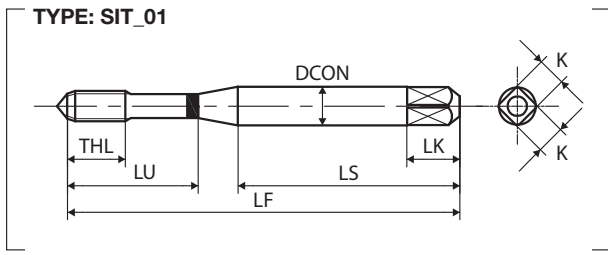

M-MF	TCTR (tolerance)	Code	LF (mm)	THL (mm)	LU (mm)	LS (mm)	DCON (mm)	K (mm)	LK (mm)	Type	Stock
YMW											
M2X0.4	6H	ITM62.0EG	42	5.5	12	27	3	2.5	5	01	○
	6H	ITM62.0EN	42	4.5	12	27	3	2.5	5	02	○
M2X0.25	5H	ITM52.0BG	42	4	12	27	3	2.5	5	01	○
	5H	ITM52.0BN	42	3.5	12	27	3	2.5	5	02	○
M2.2X0.45	6H	ITM62.2FG	42	5.5	12	27	3	2.5	5	01	○
	6H	ITM62.2FN	42	4.5	12	27	3	2.5	5	02	○
M2.2X0.25	5H	ITM52.2BG	42	4	12	27	3	2.5	5	01	○
	5H	ITM52.2BN	42	3.5	12	27	3	2.5	5	02	○
M2.3X0.4	6H	ITM62.3EG	42	5.5	12	27	3	2.5	5	01	○
	6H	ITM62.3EN	42	4.5	12	27	3	2.5	5	02	○
M2.3X0.25	5H	ITM52.3BG	42	4	12	27	3	2.5	5	01	○
	5H	ITM52.3BN	42	3.5	12	27	3	2.5	5	02	○
M2.5X0.45	6H	ITM62.5FG	46	5.5	14	29	3	2.5	5	01	○
	6H	ITM62.5FN	46	4.5	14	29	3	2.5	5	02	○
M2.5X0.35	6H	ITM62.5DG	46	4.5	14	29	3	2.5	5	01	○
	6H	ITM62.5DN	46	3.5	14	29	3	2.5	5	02	○
M2.6X0.45	6H	ITM62.6FG	46	5.5	14	29	3	2.5	5	01	○
	6H	ITM62.6FN	46	4.5	14	29	3	2.5	5	02	○
M2.6X0.35	6H	ITM62.6DG	46	4.5	14	29	3	2.5	5	01	○
	6H	ITM62.6DN	46	3.5	14	29	3	2.5	5	02	○
M3X0.5	6H	ITM63.0GG	46	5.5	14	26	4	3.2	6	01	○
	6H	ITM63.0GN	46	4.5	14	26	4	3.2	6	02	○

Intro

SP

SL

PO

ST

ROLL

CARBIDE

LONG

HAND TAPS

EG (STI)

SPECIAL THREADS, GAUGES YMW

THREAD MILLS

DIES

CENTER DRILLS

Technical info

Special Threads, Gauges

Intro

SP

SL

PO

ST

ROLL

CARBIDE

LONG

HAND TAPS

EG (STI)

SPECIAL THREADS, GAUGES YMW

THREAD MILLS

DIES

CENTER DRILLS

Technical info

M-MF	TCTR (tolerance)	Code	LF (mm)	THL (mm)	LU (mm)	LS (mm)	DCON (mm)	K (mm)	LK (mm)	Type	Stock
YMW											
M3X0.35	6H	ITM63.0DG	46	4.5	14	26	4	3.2	6	01	○
	6H	ITM63.0DN	46	3.5	14	26	4	3.2	6	02	○
M3.5X0.6	6H	ITM63.5HG	52	7.5	16	29	5	4	7	01	○
	6H	ITM63.5HN	52	6	16	29	5	4	7	02	○
M3.5X0.35	6H	ITM63.5DG	52	4.5	16	29	5	4	7	01	○
	6H	ITM63.5DN	52	3.5	16	29	5	4	7	02	○
M4X0.7	6H	ITM64.0IG	52	7.5	17	29	5	4	7	01	○
	6H	ITM64.0IN	52	6	17	29	5	4	7	02	○
M4X0.5	6H	ITM64.0GG	52	7.5	17	29	5	4	7	01	○
	6H	ITM64.0GN	52	6	17	29	5	4	7	02	○
M4.5X0.75	6H	ITM64.5JG	60	7.5	21	33	5.5	4.5	7	01	○
	6H	ITM64.5JN	60	6	21	33	5.5	4.5	7	02	○
M4.5X0.5	6H	ITM64.5GG	60	7.5	21	33	5.5	4.5	7	01	○
	6H	ITM64.5GN	60	6	21	33	5.5	4.5	7	02	○
M5X0.8	6H	ITM65.0KG	60	10	22	33	5.5	4.5	7	01	○
	6H	ITM65.0KN	60	6	22	33	5.5	4.5	7	02	○
M5X0.5	6H	ITM65.0GG	60	7	22	33	5.5	4.5	7	01	○
	6H	ITM65.0GN	60	6	22	33	5.5	4.5	7	02	○
M5.5X0.5	6H	ITM65.5GG	62	7	26	33	6	4.5	7	01	○
	6H	ITM65.5GN	62	6	26	33	6	4.5	7	02	○
M6X1	6H	ITM66.0MG	62	10	26	33	6	4.5	7	01	○
	6H	ITM66.0MN	62	6	26	33	6	4.5	7	02	○
M6X0.75	6H	ITM66.0JG	62	7.5	26	33	6	4.5	7	01	○
	6H	ITM66.0JN	62	6	26	33	6	4.5	7	02	○
M7X1	6H	ITM67.0MG	70	12	34	36	6.2	5	8	03	○
	6H	ITM67.0MN	70	6	34	36	6.2	5	8	04	○
M7X0.75	6H	ITM67.0JG	70	9	34	36	6.2	5	8	03	○
	6H	ITM67.0JN	70	6	34	36	6.2	5	8	04	○
M8X1.25	6H	ITM68.0NG	70	15	34	36	6.2	5	8	03	○
	6H	ITM68.0NN	70	10	34	36	6.2	5	8	04	○
M8X1	6H	ITM68.0MG	70	12	34	36	6.2	5	8	03	○
	6H	ITM68.0MN	70	6	34	36	6.2	5	8	04	○
M8X0.75	6H	ITM68.0JG	70	9	34	36	6.2	5	8	03	○
	6H	ITM68.0JN	70	6	34	36	6.2	5	8	04	○
M9X1.25	6H	ITM69.0NG	75	15	37	38	7	5.5	8	03	○
	6H	ITM69.0NN	75	10	37	38	7	5.5	8	04	○
M9X1	6H	ITM69.0MG	75	12	37	38	7	5.5	8	03	○
	6H	ITM69.0MN	75	6	37	38	7	5.5	8	04	○
M9X0.75	6H	ITM69.0JG	75	9	37	38	7	5.5	8	03	○
	6H	ITM69.0JN	75	6	37	38	7	5.5	8	04	○
M10X1.5	6H	ITM60100G	75	15	37	38	7	5.5	8	03	○
	6H	ITM60100N	75	10	37	38	7	5.5	8	04	○
M10X1.25	6H	ITM6010NG	75	15	37	38	7	5.5	8	03	○
	6H	ITM6010NN	75	10	37	38	7	5.5	8	04	○
M10X1	6H	ITM6010MG	75	12	37	38	7	5.5	8	03	○
	6H	ITM6010MN	75	6	37	38	7	5.5	8	04	○

M-MF	TCTR (tolerance)	Code	LF (mm)	THL (mm)	LU (mm)	LS (mm)	DCON (mm)	K (mm)	LK (mm)	Type	Stock	
YMW												Intro
M10X0.75	6H	ITM6010JG	75	9	37	38	7	5.5	8	03	○	
	6H	ITM6010JN	75	6	37	38	7	5.5	8	04	○	SP
M11X1.5	6H	ITM60110G	82	19	40	42	8.5	6.5	9	03	○	
	6H	ITM60110N	82	10	40	42	8.5	6.5	9	04	○	
M11X1	6H	ITM6011MG	82	12	40	42	8.5	6.5	9	03	○	
	6H	ITM6011MN	82	6	40	42	8.5	6.5	9	04	○	SL
M11X0.75	6H	ITM6011JG	82	10	40	42	8.5	6.5	9	03	○	
	6H	ITM6011JN	82	6	40	42	8.5	6.5	9	04	○	
M12X1.75	6H	ITM6012PG	82	20	40	42	8.5	6.5	9	03	○	
	6H	ITM6012PN	82	10	40	42	8.5	6.5	9	04	○	PO
M12X1.5	6H	ITM60120G	82	20	40	42	8.5	6.5	9	03	○	
	6H	ITM60120N	82	10	40	42	8.5	6.5	9	04	○	
M12X1.25	6H	ITM6012NG	82	15	40	42	8.5	6.5	9	03	○	
	6H	ITM6012NN	82	10	40	42	8.5	6.5	9	04	○	ST
M12X1	6H	ITM6012MG	82	12	40	42	8.5	6.5	9	03	○	
	6H	ITM6012MN	82	6	40	42	8.5	6.5	9	04	○	ROLL
M14X2	6H	ITM6014QG	88	20	43	45	10.5	8	11	03	○	
	6H	ITM6014QN	88	12	43	45	10.5	8	11	04	○	
M14X1.5	6H	ITM60140G	88	20	43	45	10.5	8	11	03	○	
	6H	ITM60140N	88	12	43	45	10.5	8	11	04	○	CARBIDE
M14X1.25	6H	ITM6014NG	88	15	43	45	10.5	8	11	03	○	
	6H	ITM6014NN	88	12	43	45	10.5	8	11	04	○	
M14X1	6H	ITM6014MG	88	12	43	45	10.5	8	11	03	○	
	6H	ITM6014MN	88	6	43	45	10.5	8	11	04	○	LONG
M15X1.5	6H	ITM60150G	95	19	47	48	12.5	10	13	03	○	
	6H	ITM60150N	95	10	47	48	12.5	10	13	04	○	
M15X1	6H	ITM6015MG	95	12	47	48	12.5	10	13	03	○	
	6H	ITM6015MN	95	10	47	48	12.5	10	13	04	○	HAND TAPS
M16X2	6H	ITM6016QG	95	20	47	48	12.5	10	13	03	○	
	6H	ITM6016QN	95	12	47	48	12.5	10	13	04	○	
M16X1.5	6H	ITM60160G	95	20	47	48	12.5	10	13	03	○	
	6H	ITM60160N	95	12	47	48	12.5	10	13	04	○	EG (STI)
M16X1	6H	ITM6016MG	95	12	47	48	12.5	10	13	03	○	
	6H	ITM6016MN	95	8	47	48	12.5	10	13	04	○	SPECIAL THREADS, GAUGES YMW
M17X1.5	6H	ITM60170G	100	19	49	51	14	11	14	03	○	
	6H	ITM60170N	100	10	49	51	14	11	14	04	○	
M17X1	6H	ITM6017MG	100	12	49	51	14	11	14	03	○	
	6H	ITM6017MN	100	10	49	51	14	11	14	04	○	THREAD MILLS
M18X2.5	6H	ITM6018RG	100	25	49	51	14	11	14	03	○	
	6H	ITM6018RN	100	16	49	51	14	11	14	04	○	
M18X2	6H	ITM6018QG	100	20	49	51	14	11	14	03	○	
	6H	ITM6018QN	100	12	49	51	14	11	14	04	○	DIES
M18X1.5	6H	ITM60180G	100	20	49	51	14	11	14	03	○	
	6H	ITM60180N	100	12	49	51	14	11	14	04	○	
M18X1	6H	ITM6018MG	100	12	49	51	14	11	14	03	○	
	6H	ITM6018MN	100	8	49	51	14	11	14	04	○	CENTER DRILLS

Technical info

Special Threads, Gauges

Intro

M-MF	TCTR (tolerance)	Code	LF (mm)	THL (mm)	LU (mm)	LS (mm)	DCON (mm)	K (mm)	LK (mm)	Type	Stock
YMW											
M20X2.5	6H	ITM6020RG	105	25	55	50	15	12	15	05	○
	6H	ITM6020RN	105	16	55	50	15	12	15	06	○
M20X2	6H	ITM6020QG	105	20	55	50	15	12	15	05	○
	6H	ITM6020QN	105	12	55	50	15	12	15	06	○
M20X1.5	6H	ITM60200G	105	20	55	50	15	12	15	05	○
	6H	ITM60200N	105	12	55	50	15	12	15	06	○
M20X1	6H	ITM6020MG	105	14	55	50	15	12	15	05	○
	6H	ITM6020MN	105	8	55	50	15	12	15	06	○
M22X2.5	6H	ITM6022RG	115	33	60	55	17	13	16	05	○
	6H	ITM6022RN	115	16	60	55	17	13	16	06	○
M22X2	6H	ITM6022QG	115	20	60	55	17	13	16	05	○
	6H	ITM6022QN	115	14	60	55	17	13	16	06	○
M22X1.5	6H	ITM60220G	115	20	60	55	17	13	16	05	○
	6H	ITM60220N	115	14	60	55	17	13	16	06	○
M22X1	6H	ITM6022MG	115	14	60	55	17	13	16	05	○
	6H	ITM6022MN	115	8	60	55	17	13	16	06	○
M24X3	6H	ITM6024SG	120	30	65	55	19	15	18	05	○
	6H	ITM6024SN	120	20	65	55	19	15	18	06	○
M24X2	6H	ITM6024QG	120	20	65	55	19	15	18	05	○
	6H	ITM6024QN	120	14	65	55	19	15	18	06	○
M24X1.5	6H	ITM60240G	120	20	65	55	19	15	18	05	○
	6H	ITM60240N	120	14	65	55	19	15	18	06	○
M24X1	6H	ITM6024MG	120	14	65	55	19	15	18	05	○
	6H	ITM6024MN	120	8	65	55	19	15	18	06	○

HAND TAPS

UNC-UNF	TCTR (tolerance)	Code	LF (mm)	THL (mm)	LU (mm)	LS (mm)	DCON (mm)	K (mm)	LK (mm)	Type	Stock
YMW											
No.2-56UNC	2B	ITM2UN2EG	42	4.5	12	26	3	2.5	5	01	○
	2B	ITM2UN2EN	42	3.5	12	26	3	2.5	5	02	○
No.2-64UNF	2B	ITM2UN2DG	42	4.5	12	26	3	2.5	5	01	○
	2B	ITM2UN2DN	42	3.5	12	26	3	2.5	5	02	○
No.3-48UNC	2B	ITM2UN3FG	46	6.5	14	28	3	2.5	5	01	○
	2B	ITM2UN3FN	46	3.5	14	28	3	2.5	5	02	○
No.3-56UNF	2B	ITM2UN3EG	46	6.5	14	28	3	2.5	5	01	○
	2B	ITM2UN3EN	46	3.5	14	28	3	2.5	5	02	○
No.4-40UNC	2B	ITM2UN4HG	46	6.5	14	25	4	3.2	6	01	○
	2B	ITM2UN4HN	46	3.5	14	25	4	3.2	6	02	○
No.4-48UNF	2B	ITM2UN4FG	46	6.5	14	25	4	3.2	6	01	○
	2B	ITM2UN4FN	46	3.5	14	25	4	3.2	6	02	○
No.5-40UNC	2B	ITM2UN5HG	52	6.5	16	28	5	4	7	01	○
	2B	ITM2UN5HN	52	3.5	16	28	5	4	7	02	○
No.5-44UNF	2B	ITM2UN5GG	52	6.5	16	28	5	4	7	01	○
	2B	ITM2UN5GN	52	3.5	16	28	5	4	7	02	○
No.6-32UNC	2B	ITM2UN6JG	52	7	17	27	5	4	7	01	○
	2B	ITM2UN6JN	52	3.5	17	27	5	4	7	02	○
No.6-40UNF	2B	ITM2UN6HG	52	7	17	27	5	4	7	01	○
	2B	ITM2UN6HN	52	3.5	17	27	5	4	7	02	○

Technical info

UNC-UNF	TCTR (tolerance)	Code	LF (mm)	THL (mm)	LU (mm)	LS (mm)	DCON (mm)	K (mm)	LK (mm)	Type	Stock
YMW											
No.8-32UNC	2B	ITM2UN8JG	60	9	22	31	5.5	4.5	7	01	○
	2B	ITM2UN8JN	60	5	22	31	5.5	4.5	7	02	○
No.8-36UNF	2B	ITM2UN8IG	60	9	22	31	5.5	4.5	7	01	○
	2B	ITM2UN8IN	60	5	22	31	5.5	4.5	7	02	○
No.10-24UNC	2B	ITM2UNAMG	60	9.5	22	32	5.5	4.5	7	01	○
	2B	ITM2UNAMN	60	5	22	32	5.5	4.5	7	02	○
No.10-32UNF	2B	ITM2UNAJG	60	9.5	22	32	5.5	4.5	7	01	○
	2B	ITM2UNAJN	60	5	22	32	5.5	4.5	7	02	○
No.12-24UNC	2B	ITM2UNCMG	62	9.5	26	32	6	4.5	7	01	○
	2B	ITM2UNCMN	62	5	26	32	6	4.5	7	02	○
No.12-28UNF	2B	ITM2UNCKG	62	9.5	26	32	6	4.5	7	01	○
	2B	ITM2UNCKN	62	5	26	32	6	4.5	7	02	○
1/4-20UNC	2B	ITM2U04NG	62	15	26	32	6	4.5	7	01	○
	2B	ITM2U04NN	62	10	26	32	6	4.5	7	02	○
1/4-28UNF	2B	ITM2U04KG	62	12	26	32	6	4.5	7	01	○
	2B	ITM2U04KN	62	7	26	32	6	4.5	7	02	○
5/16-18UNC	2B	ITM2U05OG	70	15	34	36	6.2	5	8	03	○
	2B	ITM2U05ON	70	10	34	36	6.2	5	8	04	○
5/16-24UNF	2B	ITM2U05MG	70	15	34	36	6.2	5	8	03	○
	2B	ITM2U05MN	70	7	34	36	6.2	5	8	04	○
3/8-16UNC	2B	ITM2U06PG	75	17	37	38	7	5.5	8	03	○
	2B	ITM2U06PN	75	10	37	38	7	5.5	8	04	○
3/8-24UNF	2B	ITM2U06MG	75	17	37	38	7	5.5	8	03	○
	2B	ITM2U06MN	75	10	37	38	7	5.5	8	04	○
7/16-14UNC	2B	ITM2U07QG	82	17	40	42	8.5	6.5	9	03	○
	2B	ITM2U07QN	82	10	40	42	8.5	6.5	9	04	○
7/16-20UNF	2B	ITM2U07NG	82	17	40	42	8.5	6.5	9	03	○
	2B	ITM2U07NN	82	10	40	42	8.5	6.5	9	04	○
1/2-13UNC	2B	ITM2U08RG	88	17	43	45	10.5	8	11	03	○
	2B	ITM2U08RN	88	13	43	45	10.5	8	11	04	○
1/2-20UNF	2B	ITM2U08NG	88	17	43	45	10.5	8	11	03	○
	2B	ITM2U08NN	88	10	43	45	10.5	8	11	04	○
9/16-12UNC	2B	ITM2U09SG	95	26	47	48	12.5	10	13	03	○
	2B	ITM2U09SN	95	17	47	48	12.5	10	13	04	○
9/16-18UNF	2B	ITM2U09OG	95	20	47	48	12.5	10	13	03	○
	2B	ITM2U09ON	95	13	47	48	12.5	10	13	04	○
5/8-11UNC	2B	ITM2U10UG	95	26	47	48	12.5	10	13	03	○
	2B	ITM2U10UN	95	17	47	48	12.5	10	13	04	○
5/8-18UNF	2B	ITM2U10OG	95	20	47	48	12.5	10	13	03	○
	2B	ITM2U10ON	95	13	47	48	12.5	10	13	04	○

Intro

SP

SL

PO

ST

ROLL

CARBIDE

LONG

HAND TAPS

EG (STI)

SPECIAL THREADS, GAUGES YMW

THREAD MILLS

DIES

CENTER DRILLS

Technical info

Intro

SITD

Inspection Tools

SP

Simple Thread Inspection Tools, Tandem Type

SL

HSS

PO

ST

ROLL

CARBIDE

LONG

HAND
TAPS

EG (STI)

SPECIAL
THREADS,
GAUGES,
YMWTHREAD
MILLS

DIES

CENTER
DRILLSTechnical
info

FEATURES

HSS material increases considerably the gauge life.

Product Features

- Under normal inspection procedure, the finished thread is checked by a 2-step process, by using GP GO gauge first and then NP/WP NO-GO gauge.
- Yamawa Thread Inspection Tool makes the thread inspection a 1-step process.
- SITD, attached to a measuring machine, enables the mechanical measuring.
- Even in difficult-to-insert thread inspection such as checking smaller sizes and/or finer pitch threads, smooth inspection becomes possible due to the step screw thread features of SITD.

- What is the SITD?
- Both GO part and NOT-GO part are embedded in one tool.

- Cleaning groove
- Cleaning groove of the thread portion helps to remove the small particles left inside the internal threads and hence allows a smooth and accurate inspection procedure.

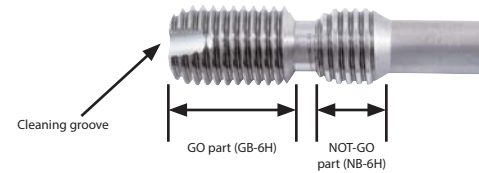

Accuracy of SITD

Simple pitch diameter tolerance, pitch tolerance and thread half angle tolerance, are 3 important factors on measuring internal screw threads. For SITD and thread plug gauge these values are the same.

Comparison between GB-6H/and GP-6H/thread plug gauge

Size	OD				PD				Pitch tolerance (±)	Tolerance for thread half angle (±minute)
	Basic size	Max	Min	Tol.	Basic size	Max	Min	Tol.		
GB-6H M6×1	6.000	6.023	6.001	0.022	5.350	5.3675	5.3565	0.011	0.005	15
GP-6H M6×1	6.000	6.023	6.001	0.022	5.350	5.3675	5.3565	0.011	0.005	15

The pitch diameter is simple pitch diameter. Pitch tolerance includes error of thread lead.

Comparison between NB-6H/and NP-6H/thread plug gauge

Size	OD				PD				Pitch tolerance (±)	Tolerance for thread half angle (±minute)
	Basic size	Max	Min	Tol.	Basic size	Max	Min	Tol.		
NB-6H M6×1	5.7055	5.7165	5.6945	0.022	5.500	5.511	5.500	0.011	0.005	16
NP-6H M6×1	5.7055	5.7165	5.6945	0.022	5.500	5.511	5.500	0.011	0.005	16

Main specification of SITD is same with that of thread gauge. But SITD has partly Yamawa's own design in the length of thread and bottom part relief. Due to these features, Yamawa has adopted the name "Simple Inspection Tool or SITD" instead of using the name "thread gauge".

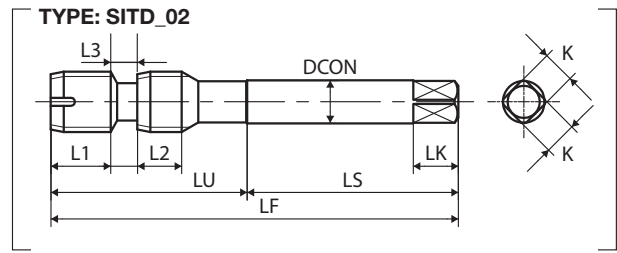
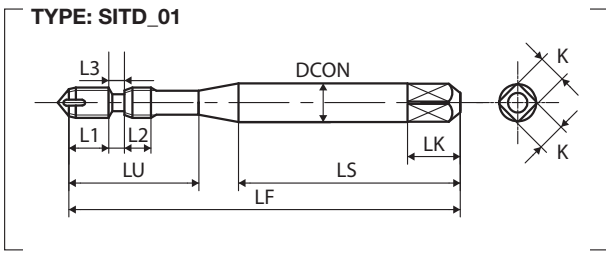

M-MF	TCTR (tolerance)	Code	LF (mm)	L1 (mm)	L2 (mm)	L3 (mm)	LU (mm)	LS (mm)	DCON (mm)	K (mm)	LK (mm)	Type	Stock
YMW													
M2X0.4	6H	ITDM62.0E	42	4	2	1.2	12	27	3	2.5	5	01	○
M2X0.25	5H	ITDM52.0B	42	4.9	1.3	1	12	27	3	2.5	5	01	○
M2.2X0.45	6H	ITDM62.2F	42	4.4	2.3	1.4	12	27	3	2.5	5	01	○
M2.2X0.25	5H	ITDM52.2B	42	5.8	1.3	1	12	27	3	2.5	5	01	○
M2.3X0.4	6H	ITDM62.3E	42	4	2	1.2	12	27	3	2.5	5	01	○
M2.3X0.25	5H	ITDM52.3B	42	4.9	1.3	1	12	27	3	2.5	5	01	○
M2.5X0.45	6H	ITDM62.5F	46	4.4	2.3	1.4	14	29	3	2.5	5	01	○
M2.5X0.35	6H	ITDM62.5D	46	5.2	1.8	1.1	14	29	3	2.5	5	01	○
M2.6X0.45	6H	ITDM62.6F	46	4.4	2.3	1.4	14	29	3	2.5	5	01	○
M2.6X0.35	6H	ITDM62.6D	46	5.2	1.8	1.1	14	29	3	2.5	5	01	○
M3X0.5	6H	ITDM63.0G	46	5	2.5	1.5	14	26	4	3.2	6	01	○
M3X0.35	6H	ITDM63.0D	46	6.1	1.8	1.1	14	26	4	3.2	6	01	○
M3.5X0.6	6H	ITDM63.5H	52	6.2	3	1.8	16	29	5	4	7	01	○
M3.5X0.35	6H	ITDM63.5D	52	8.1	1.8	1.1	16	29	5	4	7	01	○
M4X0.7	6H	ITDM64.0I	52	5.4	3.5	2.1	17	29	5	4	7	01	○
M4X0.5	6H	ITDM64.0G	52	7	2.5	1.5	17	29	5	4	7	01	○
M4.5X0.75	6H	ITDM64.5J	60	6.9	3.8	2.3	21	33	5.5	4.5	7	01	○
M4.5X0.5	6H	ITDM64.5G	60	9	2.5	1.5	21	33	5.5	4.5	7	01	○
M5X0.8	6H	ITDM65.0K	60	6.6	4	2.4	22	33	5.5	4.5	7	01	○
M5X0.5	6H	ITDM65.0G	60	9	2.5	1.5	22	33	5.5	4.5	7	01	○
M5.5X0.5	6H	ITDM65.5G	62	11	2.5	1.5	26	33	6	4.5	7	01	○
M6X1	6H	ITDM66.0M	62	7	5	3	26	33	6	4.5	7	01	○
M6X0.75	6H	ITDM66.0J	62	8.9	3.8	2.3	26	33	6	4.5	7	01	○
M7X1	6H	ITDM67.0M	70	11.9	5	3	34	36	6.2	5	8	02	○
M7X0.75	6H	ITDM67.0J	70	13.8	3.8	2.3	34	36	6.2	5	8	02	○
M8X1.25	6H	ITDM68.0N	70	8.9	6.3	3.8	34	36	6.2	5	8	02	○
M8X1	6H	ITDM68.0M	70	11	5	3	34	36	6.2	5	8	02	○
M8X0.75	6H	ITDM68.0J	70	12.9	3.8	2.3	34	36	6.2	5	8	02	○
M9X1.25	6H	ITDM69.0N	75	13.8	6.3	3.8	37	38	7	5.5	8	02	○
M9X1	6H	ITDM69.0M	75	15.9	5	3	37	38	7	5.5	8	02	○
M9X0.75	6H	ITDM69.0J	75	17.8	3.8	2.3	37	38	7	5.5	8	02	○
M10X1.5	6H	ITDM60100	75	11	7.5	4.5	37	38	7	5.5	8	02	○
M10X1.25	6H	ITDM6010N	75	12.9	6.3	3.8	37	38	7	5.5	8	02	○
M10X1	6H	ITDM6010M	75	15	5	3	37	38	7	5.5	8	02	○
M10X0.75	6H	ITDM6010J	75	16.9	3.8	2.3	37	38	7	5.5	8	02	○
M11X1.5	6H	ITDM60110	82	14.9	7.5	4.5	40	42	8.5	6.5	9	02	○
M11X1	6H	ITDM6011M	82	18.9	5	3	40	42	8.5	6.5	9	02	○

Intro

SP

SL

PO

ST

ROLL

CARBIDE

LONG

HAND TAPS

EG (STI)

SPECIAL THREADS, GAUGES YMW

THREAD MILLS

DIES

CENTER DRILLS

Technical info

Special Threads, Gauges

Intro

	M-MF	TCTR (tolerance)	Code	LF (mm)	L1 (mm)	L2 (mm)	L3 (mm)	LU (mm)	LS (mm)	DCON (mm)	K (mm)	LK (mm)	Type	Stock
	YMW													
	M11X0.75	6H	ITDM6011J	82	20.8	3.8	2.3	40	42	8.5	6.5	9	02	○
SP	M12X1.75	6H	ITDM6012P	82	11.9	8.8	5.3	40	42	8.5	6.5	9	02	○
	M12X1.5	6H	ITDM6012O	82	14	7.5	4.5	40	42	8.5	6.5	9	02	○
	M12X1.25	6H	ITDM6012N	82	15.9	6.3	3.8	40	42	8.5	6.5	9	02	○
SL	M12X1	6H	ITDM6012M	82	18	5	3	40	42	8.5	6.5	9	02	○
	M14X2	6H	ITDM6014Q	88	10	10	6	43	45	10.5	8	11	02	○
	M14X1.5	6H	ITDM6014O	88	14	7.5	4.5	43	45	10.5	8	11	02	○
	M14X1.25	6H	ITDM6014N	88	15.9	6.3	3.8	43	45	10.5	8	11	02	○
PO	M14X1	6H	ITDM6014M	88	18	5	3	43	45	10.5	8	11	02	○
	M15X1.5	6H	ITDM6015O	95	14.9	7.5	4.5	47	48	12.5	10	13	02	○
	M15X1	6H	ITDM6015M	95	18.9	5	3	47	48	12.5	10	13	02	○
ST	M16X2	6H	ITDM6016Q	95	10	10	6	47	48	12.5	10	13	02	○
	M16X1.5	6H	ITDM6016O	95	14	7.5	4.5	47	48	12.5	10	13	02	○
	M16X1	6H	ITDM6016M	95	18	5	3	47	48	12.5	10	13	02	○
	M17X1.5	6H	ITDM6017O	100	21.9	7.5	4.5	49	51	14	11	14	02	○
ROLL	M17X1	6H	ITDM6017M	100	25.9	5	3	49	51	14	11	14	02	○
	M18X2.5	6H	ITDM6018R	100	13	12.5	7.5	49	51	14	11	14	02	○
	M18X2	6H	ITDM6018Q	100	17	10	6	49	51	14	11	14	02	○
	M18X1.5	6H	ITDM6018O	100	21	7.5	4.5	49	51	14	11	14	02	○
CARBIDE	M18X1	6H	ITDM6018M	100	25	5	3	49	51	14	11	14	02	○

	UNC-UNF	TCTR (tolerance)	Code	LF (mm)	L1 (mm)	L2 (mm)	L3 (mm)	LU (mm)	LS (mm)	DCON (mm)	K (mm)	LK (mm)	Type	Stock
--	---------	---------------------	------	------------	------------	------------	------------	------------	------------	--------------	-----------	------------	------	-------

YMW

LONG

	No.2-56UNC	2B	ITDM2UN2E	42	4.4	2.3	1.4	12	26	3	2.5	5	01	○
	No.2-64UNF	2B	ITDM2UN2D	42	4.9	2	1.2	12	26	3	2.5	5	01	○
	No.3-48UNC	2B	ITDM2UN3F	46	3.9	2.6	1.6	14	28	3	2.5	5	01	○
HAND TAPS	No.3-56UNF	2B	ITDM2UN3E	46	4.4	2.3	1.4	14	28	3	2.5	5	01	○
	No.4-40UNC	2B	ITDM2UN4H	46	3.9	3.2	1.9	14	25	4	3.2	6	01	○
	No.4-48UNF	2B	ITDM2UN4F	46	4.8	2.6	1.6	14	25	4	3.2	6	01	○
	No.5-40UNC	2B	ITDM2UN5H	52	5.9	3.2	1.9	16	28	5	4	7	01	○
EG (STI)	No.5-44UNF	2B	ITDM2UN5G	52	6.4	2.9	1.7	16	28	5	4	7	01	○
	No.6-32UNC	2B	ITDM2UN6J	52	4.6	4	2.4	17	27	5	4	7	01	○
	No.6-40UNF	2B	ITDM2UN6H	52	5.9	3.2	1.9	17	27	5	4	7	01	○
SPECIAL THREADS, GAUGES YMW	No.8-32UNC	2B	ITDM2UN8J	60	6.6	4	2.4	22	31	5.5	4.5	7	01	○
	No.8-36UNF	2B	ITDM2UN8I	60	7.4	3.5	2.1	22	31	5.5	4.5	7	01	○
	No.10-24UNC	2B	ITDM2UNAM	62	7.5	5.3	3.2	26	32	6	4.5	7	01	○
	No.10-32UNF	2B	ITDM2UNAJ	62	9.6	4	2.4	26	32	6	4.5	7	01	○
THREAD MILLS	No.12-24UNC	2B	ITDM2UNCM	62	6.5	5.3	3.2	26	32	6	4.5	7	01	○
	No.12-28UNF	2B	ITDM2UNCK	62	7.8	4.5	2.7	26	32	6	4.5	7	01	○
	1/4-20UNC	2B	ITDM2U04N	70	10.2	6.4	3.8	34	36	6.2	5	8	02	○
	1/4-28UNF	2B	ITDM2U04K	70	13.2	4.5	2.7	34	36	6.2	5	8	02	○
DIES	5/16-18UNC	2B	ITDM2U05O	70	7.7	7.1	4.2	34	36	6.2	5	8	02	○
	5/16-24UNF	2B	ITDM2U05M	70	10.5	5.3	3.2	34	36	6.2	5	8	02	○
	3/8-16UNC	2B	ITDM2U06P	75	10.7	7.9	4.8	37	38	7	5.5	8	02	○
CENTER DRILLS	3/8-24UNF	2B	ITDM2U06M	75	14.9	5.3	3.2	37	38	7	5.5	8	02	○
	7/16-14UNC	2B	ITDM2U07Q	82	12.3	9.1	5.4	40	42	8.5	6.5	9	02	○
	7/16-20UNF	2B	ITDM2U07N	82	16.6	6.4	3.8	40	42	8.5	6.5	9	02	○

Technical info

UNC-UNF	TCTR (tolerance)	Code	LF (mm)	L1 (mm)	L2 (mm)	L3 (mm)	LU (mm)	LS (mm)	DCON (mm)	K (mm)	LK (mm)	Type	Stock
YMW													
1/2-13UNC	2B	ITDM2U08R	88	11.4	9.8	5.9	43	45	10.5	8	11	02	○
1/2-20UNF	2B	ITDM2U08N	88	16.9	6.4	3.8	43	45	10.5	8	11	02	○
9/16-12UNC	2B	ITDM2U09S	95	10.5	10.6	6.4	47	48	12.5	10	13	02	○
9/16-18UNF	2B	ITDM2U090	95	16.2	7.1	4.2	47	48	12.5	10	13	02	○
5/8-11UNC	2B	ITDM2U10U	100	16.4	11.5	6.9	49	51	14	11	14	02	○
5/8-18UNF	2B	ITDM2U100	100	23.5	7.1	4.2	49	51	14	11	14	02	○

Intro

SP

SL

PO

ST

ROLL

CARBIDE

LONG

HAND
TAPS

EG (STI)

SPECIAL
THREADS,
GAUGES
YMWTHREAD
MILLS

DIES

CENTER
DRILLSTechnical
info

Intro

CHECK PINS

SP

How to use Check Pins

You can check both hole size and hole condition at the same time by this Check-pin!

SL

PO

ST

ROLL

CARBIDE

LONG

HAND TAPS

EG (STI)

5th
Step

Thread Inspection using Simple Inspection Tool



It is important to check the hole condition before tapping

Hole condition can be inappropriate before tapping.

Accurate hole size and shape, enable longer tool life and avoid tapping troubles. Let's check the hole before tapping.

SPECIAL THREADS, GAUGES, YMW

THREAD MILLS

DIES

CENTER DRILLS

Technical info



CHECK PINS



Intro

SP

SL

PO

ST

ROLL

CARBIDE

LONG

HAND TAPS

EG (STI)

SPECIAL THREADS, GAUGES YMW

THREAD MILLS

DIES

CENTER DRILLS

Technical info

Please check the hole size before tapping

Let's check the hole size before tapping 6H class internal threads of M6×1 by using Check-pin for cutting taps.

How to use CPC-S (Straight type)

STEP
1

Check the minor dia. for M6×1 6H internal thread

STEP
2

Size of the Check-pin for M6×1

Size	L	ℓ	DS	d1 (Percentage of thread engagement)	d2 (Percentage of thread engagement)
M6 ×1	73	16.5	6	4.917 (100%)	5.026 (90%)
				4.972 (95%)	5.080 (85%)
				5.026 (90%)	5.134 (80%)
				5.080 (85%)	5.188 (75%)
				5.134 (80%)	5.242 (70%)

Select the two Check-Pins closest to the max and min size of minor dia of 6H internal thread, referring to the table on the left.

① **4.917(100%)** and ② **5.134(80%)**

Depending on the feature of work-piece materials, it is beneficial to tapping to make the hole size before tapping as large as possible and within the tolerance.

STEP
3

Insert the Check-pins ① and ②, selected in step 2.

① **4.917**
(100%)



Check-pin smoothly goes into the bottom of the hole.



② **5.134**
(80%)

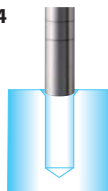

Check-pin doesn't go into the hole.

GOOD

The hole is finished within minor dia of 6H class internal threads.

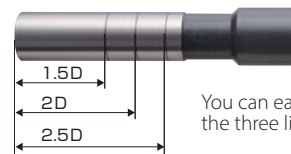

You can easily check hole depth by the three lines marked on the pin.

Intro

CPC-S

Inspection Tools

SP

Check Pins (Straight Type) for Bored Hole for Cutting Taps

SL

HSS

PO

ST

ROLL

CARBIDE

LONG

HAND
TAPS

EG (STI)

SPECIAL
THREADS,
GAUGES
YMW

THREAD
MILLS

DIES

CENTER
DRILLS

Technical
info



FEATURES

HSS material increases considerably the Check Pins life.

A set of 5 Check Pins allows accurate checking of bored hole diameter and length.

For cutting tap.

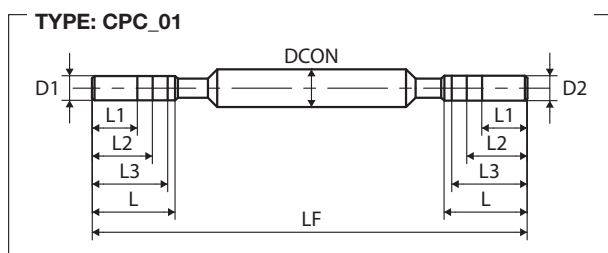

M-MF	Code	LF (mm)	L (mm)	D1 (Thread engagement ratio)	D2 (Thread engagement ratio)	DCON (mm)	L1 (mm)	L2 (mm)	L3 (mm)	Type	Stock	
YMW												Intro
M2X0.4	CPCS2.0EA	41.5	5.5	1.567 (100%)	1.610 (90%)	3	3	4	5	01	○	
	CPCS2.0EB	41.5	5.5	1.589 (95%)	1.632 (85%)	3	3	4	5	01	○	SP
	CPCS2.0EC	41.5	5.5	1.610 (90%)	1.654 (80%)	3	3	4	5	01	○	
	CPCS2.0ED	41.5	5.5	1.632 (85%)	1.675 (75%)	3	3	4	5	01	○	
	CPCS2.0EE	41.5	5.5	1.654 (80%)	1.697 (70%)	3	3	4	5	01	○	SL
	CPCS2.0EF	41.5	5.5	1.675 (75%)	1.719 (65%)	3	3	4	5	01	○	
	CPCS2.0EM	set of 5pcs. CPCS2.0EB (95%) ~ CPCS2.0EF (65%)									01	○
CPCS2.0ES	set of 5pcs. CPCS2.0EA (100%) ~ CPCS2.0EE (70%)									01	○	
M2.5X0.45	CPCS2.5FA	45	7.5	2.013 (100%)	2.062 (90%)	3	3.75	5	6.25	01	○	PO
	CPCS2.5FB	45	7.5	2.037 (95%)	2.086 (85%)	3	3.75	5	6.25	01	○	
	CPCS2.5FC	45	7.5	2.062 (90%)	2.110 (80%)	3	3.75	5	6.25	01	○	
	CPCS2.5FD	45	7.5	2.086 (85%)	2.135 (75%)	3	3.75	5	6.25	01	○	
	CPCS2.5FE	45	7.5	2.110 (80%)	2.159 (70%)	3	3.75	5	6.25	01	○	ST
	CPCS2.5FF	45	7.5	2.135 (75%)	2.183 (65%)	3	3.75	5	6.25	01	○	
	CPCS2.5FM	set of 5pcs. CPCS2.5FB (95%) ~ CPCS2.5FF (65%)									01	○
CPCS2.5FS	set of 5pcs. CPCS2.5FA (100%) ~ CPCS2.5FE (70%)									01	○	
M2.5X0.35	CPCS2.5DA	45	7.5	2.121 (100%)	2.159 (90%)	3	3.75	5	6.25	01	○	ROLL
	CPCS2.5DB	45	7.5	2.140 (95%)	2.178 (85%)	3	3.75	5	6.25	01	○	
	CPCS2.5DC	45	7.5	2.159 (90%)	2.197 (80%)	3	3.75	5	6.25	01	○	
	CPCS2.5DD	45	7.5	2.178 (85%)	2.216 (75%)	3	3.75	5	6.25	01	○	CARBIDE
	CPCS2.5DE	45	7.5	2.197 (80%)	2.235 (70%)	3	3.75	5	6.25	01	○	
	CPCS2.5DF	45	7.5	2.216 (75%)	2.254 (65%)	3	3.75	5	6.25	01	○	
	CPCS2.5DM	set of 5pcs. CPCS2.5DB (95%) ~ CPCS2.5DF (65%)									01	○
CPCS2.5DS	set of 5pcs. CPCS2.5DA (100%) ~ CPCS2.5DE (70%)									01	○	LONG
M3X0.5	CPCS3.0GA	49	9	2.459 (100%)	2.513 (90%)	4	4.5	6	7.5	01	○	
	CPCS3.0GB	49	9	2.486 (95%)	2.540 (85%)	4	4.5	6	7.5	01	○	
	CPCS3.0GC	49	9	2.513 (90%)	2.567 (80%)	4	4.5	6	7.5	01	○	HAND TAPS
	CPCS3.0GD	49	9	2.540 (85%)	2.594 (75%)	4	4.5	6	7.5	01	○	
	CPCS3.0GE	49	9	2.567 (80%)	2.621 (70%)	4	4.5	6	7.5	01	○	
	CPCS3.0GF	49	9	2.594 (75%)	2.648 (65%)	4	4.5	6	7.5	01	○	
	CPCS3.0GM	set of 5pcs. CPCS3.0GB (95%) ~ CPCS3.0GF (65%)									01	○
CPCS3.0GS	set of 5pcs. CPCS3.0GA (100%) ~ CPCS3.0GE (70%)									01	○	
M3X0.35	CPCS3.0DA	49	9	2.621 (100%)	2.659 (90%)	4	4.5	6	7.5	01	○	
	CPCS3.0DB	49	9	2.640 (95%)	2.678 (85%)	4	4.5	6	7.5	01	○	SPECIAL THREADS, GAUGES YMW
	CPCS3.0DC	49	9	2.659 (90%)	2.697 (80%)	4	4.5	6	7.5	01	○	
	CPCS3.0DD	49	9	2.678 (85%)	2.716 (75%)	4	4.5	6	7.5	01	○	
	CPCS3.0DE	49	9	2.697 (80%)	2.735 (70%)	4	4.5	6	7.5	01	○	
	CPCS3.0DF	49	9	2.716 (75%)	2.754 (65%)	4	4.5	6	7.5	01	○	THREAD MILLS
	CPCS3.0DM	set of 5pcs. CPCS3.0DB (95%) ~ CPCS3.0DF (65%)									01	○
CPCS3.0DS	set of 5pcs. CPCS3.0DA (100%) ~ CPCS3.0DE (70%)									01	○	
M3.5X0.6	CPCS3.5HA	57	11	2.850 (100%)	2.915 (90%)	5	5.25	7	8.75	01	○	DIES
	CPCS3.5HB	57	11	2.883 (95%)	2.948 (85%)	5	5.25	7	8.75	01	○	
	CPCS3.5HC	57	11	2.915 (90%)	2.980 (80%)	5	5.25	7	8.75	01	○	
	CPCS3.5HD	57	11	2.948 (85%)	3.013 (75%)	5	5.25	7	8.75	01	○	
	CPCS3.5HE	57	11	2.980 (80%)	3.045 (70%)	5	5.25	7	8.75	01	○	CENTER DRILLS
	CPCS3.5HF	57	11	3.013 (75%)	3.078 (65%)	5	5.25	7	8.75	01	○	
	CPCS3.5HM	set of 5pcs. CPCS3.5HB (95%) ~ CPCS3.5HF (65%)									01	○
CPCS3.5HS	set of 5pcs. CPCS3.5HA (100%) ~ CPCS3.5HE (70%)									01	○	

Technical info

Special Threads, Gauges

Intro

M-MF

Code

LF
(mm)

L
(mm)

D1
(Thread engagement ratio)

D2
(Thread engagement ratio)

DCON
(mm)

L1
(mm)

L2
(mm)

L3
(mm)

Type

Stock

YMW

SP

M3.5X0.35

SL

PO

ST

M4X0.7

ROLL

CARBIDE

M4X0.5

LONG

HAND
TAPS

M4.5X0.75

EG (STI)

**SPECIAL
THREADS,
GAUGES
YMW**

M4.5X0.5

THREAD
MILLS

DIES

CENTER
DRILLS

M5X0.8

Technical
info

	Code	LF (mm)	L (mm)	D1 (Thread engagement ratio)	D2 (Thread engagement ratio)	DCON (mm)	L1 (mm)	L2 (mm)	L3 (mm)	Type	Stock
	YMW										
	CPCS3.5DA	57	11	3.121 (100%)	3.159 (90%)	5	5.25	7	8.75	01	○
	CPCS3.5DB	57	11	3.140 (95%)	3.178 (85%)	5	5.25	7	8.75	01	○
	CPCS3.5DC	57	11	3.159 (90%)	3.197 (80%)	5	5.25	7	8.75	01	○
	CPCS3.5DD	57	11	3.178 (85%)	3.216 (75%)	5	5.25	7	8.75	01	○
	CPCS3.5DE	57	11	3.197 (80%)	3.235 (70%)	5	5.25	7	8.75	01	○
	CPCS3.5DF	57	11	3.216 (75%)	3.254 (65%)	5	5.25	7	8.75	01	○
	CPCS3.5DM	set of 5pcs. CPCS3.5DB (95%) ~ CPCS3.5DF (65%)								01	○
	CPCS3.5DS	set of 5pcs. CPCS3.5DA (100%) ~ CPCS3.5DE (70%)								01	○
	CPCS4.0IA	57	11	3.242 (100%)	3.318 (90%)	5	6	8	10	01	○
	CPCS4.0IB	57	11	3.280 (95%)	3.356 (85%)	5	6	8	10	01	○
	CPCS4.0IC	57	11	3.318 (90%)	3.394 (80%)	5	6	8	10	01	○
	CPCS4.0ID	57	11	3.356 (85%)	3.432 (75%)	5	6	8	10	01	○
	CPCS4.0IE	57	11	3.394 (80%)	3.470 (70%)	5	6	8	10	01	○
	CPCS4.0IF	57	11	3.432 (75%)	3.507 (65%)	5	6	8	10	01	○
	CPCS4.0IM	set of 5pcs. CPCS4.0IB (95%) ~ CPCS4.0IF (65%)								01	○
	CPCS4.0IS	set of 5pcs. CPCS4.0IA (100%) ~ CPCS4.0IE (70%)								01	○
	CPCS4.0GA	57	11	3.459 (100%)	3.513 (90%)	5	6	8	10	01	○
	CPCS4.0GB	57	11	3.486 (95%)	3.540 (85%)	5	6	8	10	01	○
	CPCS4.0GC	57	11	3.513 (90%)	3.567 (80%)	5	6	8	10	01	○
	CPCS4.0GD	57	11	3.540 (85%)	3.594 (75%)	5	6	8	10	01	○
	CPCS4.0GE	57	11	3.567 (80%)	3.621 (70%)	5	6	8	10	01	○
	CPCS4.0GF	57	11	3.594 (75%)	3.648 (65%)	5	6	8	10	01	○
	CPCS4.0GM	set of 5pcs. CPCS4.0GB (95%) ~ CPCS4.0GF (65%)								01	○
	CPCS4.0GS	set of 5pcs. CPCS4.0GA (100%) ~ CPCS4.0GE (70%)								01	○
	CPCS4.5JA	65	14	3.688 (100%)	3.769 (90%)	5.5	6.75	9	11.25	01	○
	CPCS4.5JB	65	14	3.729 (95%)	3.810 (85%)	5.5	6.75	9	11.25	01	○
	CPCS4.5JC	65	14	3.769 (90%)	3.850 (80%)	5.5	6.75	9	11.25	01	○
	CPCS4.5JD	65	14	3.810 (85%)	3.891 (75%)	5.5	6.75	9	11.25	01	○
	CPCS4.5JE	65	14	3.850 (80%)	3.932 (70%)	5.5	6.75	9	11.25	01	○
	CPCS4.5JF	65	14	3.891 (75%)	3.972 (65%)	5.5	6.75	9	11.25	01	○
	CPCS4.5JM	set of 5pcs. CPCS4.5JB (95%) ~ CPCS4.5JF (65%)								01	○
	CPCS4.5JS	set of 5pcs. CPCS4.5JA (100%) ~ CPCS4.5JE (70%)								01	○
	CPCS4.5GA	65	14	3.959 (100%)	4.013 (90%)	5.5	6.75	9	11.25	01	○
	CPCS4.5GB	65	14	3.986 (95%)	4.040 (85%)	5.5	6.75	9	11.25	01	○
	CPCS4.5GC	65	14	4.013 (90%)	4.067 (80%)	5.5	6.75	9	11.25	01	○
	CPCS4.5GD	65	14	4.040 (85%)	4.094 (75%)	5.5	6.75	9	11.25	01	○
	CPCS4.5GE	65	14	4.067 (80%)	4.121 (70%)	5.5	6.75	9	11.25	01	○
	CPCS4.5GF	65	14	4.094 (75%)	4.148 (65%)	5.5	6.75	9	11.25	01	○
	CPCS4.5GM	set of 5pcs. CPCS4.5GB (95%) ~ CPCS4.5GF (65%)								01	○
	CPCS4.5GS	set of 5pcs. CPCS4.5GA (100%) ~ CPCS4.5GE (70%)								01	○
	CPCS5.0KA	65	14	4.134 (100%)	4.221 (90%)	5.5	7.5	10	12.5	01	○
	CPCS5.0KB	65	14	4.177 (95%)	4.264 (85%)	5.5	7.5	10	12.5	01	○
	CPCS5.0KC	65	14	4.221 (90%)	4.307 (80%)	5.5	7.5	10	12.5	01	○
	CPCS5.0KD	65	14	4.264 (85%)	4.350 (75%)	5.5	7.5	10	12.5	01	○
	CPCS5.0KE	65	14	4.307 (80%)	4.394 (70%)	5.5	7.5	10	12.5	01	○
	CPCS5.0KF	65	14	4.350 (75%)	4.437 (65%)	5.5	7.5	10	12.5	01	○
	CPCS5.0KM	set of 5pcs. CPCS5.0KB (95%) ~ CPCS5.0KF (65%)								01	○
	CPCS5.0KS	set of 5pcs. CPCS5.0KA (100%) ~ CPCS5.0KE (70%)								01	○

M-MF	Code	LF (mm)	L (mm)	D1 (Thread engagement ratio)	D2 (Thread engagement ratio)	DCON (mm)	L1 (mm)	L2 (mm)	L3 (mm)	Type	Stock	Intro
YMW												
M5X0.5	CPCS5.0GA	65	14	4.459 (100%)	4.513 (90%)	5.5	7.5	10	12.5	01	○	
	CPCS5.0GB	65	14	4.486 (95%)	4.540 (85%)	5.5	7.5	10	12.5	01	○	SP
	CPCS5.0GC	65	14	4.513 (90%)	4.567 (80%)	5.5	7.5	10	12.5	01	○	
	CPCS5.0GD	65	14	4.540 (85%)	4.594 (75%)	5.5	7.5	10	12.5	01	○	
	CPCS5.0GE	65	14	4.567 (80%)	4.621 (70%)	5.5	7.5	10	12.5	01	○	SL
	CPCS5.0GF	65	14	4.594 (75%)	4.648 (65%)	5.5	7.5	10	12.5	01	○	
	CPCS5.0GM	set of 5pcs. CPCS5.0GB (95%) ~ CPCS5.0GF (65%)									01	○
CPCS5.0GS	set of 5pcs. CPCS5.0GA (100%) ~ CPCS5.0GE (70%)									01	○	
M6X1	CPCS6.0MA	73	16.5	4.917 (100%)	5.026 (90%)	6	9	12	15	01	○	PO
	CPCS6.0MB	73	16.5	4.972 (95%)	5.080 (85%)	6	9	12	15	01	○	
	CPCS6.0MC	73	16.5	5.026 (90%)	5.134 (80%)	6	9	12	15	01	○	
	CPCS6.0MD	73	16.5	5.080 (85%)	5.188 (75%)	6	9	12	15	01	○	
	CPCS6.0ME	73	16.5	5.134 (80%)	5.242 (70%)	6	9	12	15	01	○	ST
	CPCS6.0MF	73	16.5	5.188 (75%)	5.296 (65%)	6	9	12	15	01	○	
	CPCS6.0MM	set of 5pcs. CPCS6.0MB (95%) ~ CPCS6.0MF (65%)									01	○
CPCS6.0MS	set of 5pcs. CPCS6.0MA (100%) ~ CPCS6.0ME (70%)									01	○	
M6X0.75	CPCS6.0JA	73	16.5	5.188 (100%)	5.269 (90%)	6	9	12	15	01	○	ROLL
	CPCS6.0JB	73	16.5	5.229 (95%)	5.310 (85%)	6	9	12	15	01	○	
	CPCS6.0JC	73	16.5	5.269 (90%)	5.350 (80%)	6	9	12	15	01	○	
	CPCS6.0JD	73	16.5	5.310 (85%)	5.391 (75%)	6	9	12	15	01	○	CARBIDE
	CPCS6.0JE	73	16.5	5.350 (80%)	5.432 (70%)	6	9	12	15	01	○	
	CPCS6.0JF	73	16.5	5.391 (75%)	5.472 (65%)	6	9	12	15	01	○	
	CPCS6.0JM	set of 5pcs. CPCS6.0JB (95%) ~ CPCS6.0JF (65%)									01	○
CPCS6.0JS	set of 5pcs. CPCS6.0JA (100%) ~ CPCS6.0JE (70%)									01	○	LONG
M7X1	CPCS7.0MA	99	22	5.917 (100%)	6.026 (90%)	8	10.5	14	17.5	01	○	
	CPCS7.0MB	99	22	5.972 (95%)	6.080 (85%)	8	10.5	14	17.5	01	○	
	CPCS7.0MC	99	22	6.026 (90%)	6.134 (80%)	8	10.5	14	17.5	01	○	HAND TAPS
	CPCS7.0MD	99	22	6.080 (85%)	6.188 (75%)	8	10.5	14	17.5	01	○	
	CPCS7.0ME	99	22	6.134 (80%)	6.242 (70%)	8	10.5	14	17.5	01	○	
	CPCS7.0MF	99	22	6.188 (75%)	6.296 (65%)	8	10.5	14	17.5	01	○	
	CPCS7.0MM	set of 5pcs. CPCS7.0MB (95%) ~ CPCS7.0MF (65%)									01	○
CPCS7.0MS	set of 5pcs. CPCS7.0MA (100%) ~ CPCS7.0ME (70%)									01	○	
M7X0.75	CPCS7.0JA	99	22	6.188 (100%)	6.269 (90%)	8	10.5	14	17.5	01	○	
	CPCS7.0JB	99	22	6.229 (95%)	6.310 (85%)	8	10.5	14	17.5	01	○	SPECIAL THREADS, GAUGES YMW
	CPCS7.0JC	99	22	6.269 (90%)	6.350 (80%)	8	10.5	14	17.5	01	○	
	CPCS7.0JD	99	22	6.310 (85%)	6.391 (75%)	8	10.5	14	17.5	01	○	
	CPCS7.0JE	99	22	6.350 (80%)	6.432 (70%)	8	10.5	14	17.5	01	○	THREAD MILLS
	CPCS7.0JF	99	22	6.391 (75%)	6.472 (65%)	8	10.5	14	17.5	01	○	
	CPCS7.0JM	set of 5pcs. CPCS7.0JB (95%) ~ CPCS7.0JF (65%)									01	○
CPCS7.0JS	set of 5pcs. CPCS7.0JA (100%) ~ CPCS7.0JE (70%)									01	○	
M8X1.25	CPCS8.0NA	99	22	6.647 (100%)	6.782 (90%)	8	12	16	20	01	○	DIES
	CPCS8.0NB	99	22	6.714 (95%)	6.850 (85%)	8	12	16	20	01	○	
	CPCS8.0NC	99	22	6.782 (90%)	6.917 (80%)	8	12	16	20	01	○	
	CPCS8.0ND	99	22	6.850 (85%)	6.985 (75%)	8	12	16	20	01	○	
	CPCS8.0NE	99	22	6.917 (80%)	7.053 (70%)	8	12	16	20	01	○	CENTER DRILLS
	CPCS8.0NF	99	22	6.985 (75%)	7.120 (65%)	8	12	16	20	01	○	
	CPCS8.0NM	set of 5pcs. CPCS8.0NB (95%) ~ CPCS8.0NF (65%)									01	○
CPCS8.0NS	set of 5pcs. CPCS8.0NA (100%) ~ CPCS8.0NE (70%)									01	○	

Technical info

Special Threads, Gauges

Intro

M-MF

Code

LF
(mm)

L
(mm)

D1
(Thread engagement ratio)

D2
(Thread engagement ratio)

DCON
(mm)

L1
(mm)

L2
(mm)

L3
(mm)

Type

Stock

YMW

SP

M8X1

SL

PO

ST

M8X0.75

ROLL

CARBIDE

M9X1.25

LONG

HAND
TAPS

M9X1

EG (STI)

**SPECIAL
THREADS,
GAUGES
YMW**

M9X0.75

THREAD
MILLS

DIES

CENTER
DRILLS

M10X1.5

Technical
info

	M-MF	Code	LF (mm)	L (mm)	D1 (Thread engagement ratio)	D2 (Thread engagement ratio)	DCON (mm)	L1 (mm)	L2 (mm)	L3 (mm)	Type	Stock
	YMW											
		CPCS8.0MA	99	22	6.917 (100%)	7.026 (90%)	8	12	16	20	01	○
SP		CPCS8.0MB	99	22	6.972 (95%)	7.080 (85%)	8	12	16	20	01	○
		CPCS8.0MC	99	22	7.026 (90%)	7.134 (80%)	8	12	16	20	01	○
		CPCS8.0MD	99	22	7.080 (85%)	7.188 (75%)	8	12	16	20	01	○
SL		CPCS8.0ME	99	22	7.134 (80%)	7.242 (70%)	8	12	16	20	01	○
		CPCS8.0MF	99	22	7.188 (75%)	7.296 (65%)	8	12	16	20	01	○
		CPCS8.0MM	set of 5pcs. CPCS8.0MB (95%) ~ CPCS8.0MF (65%)								01	○
		CPCS8.0MS	set of 5pcs. CPCS8.0MA (100%) ~ CPCS8.0ME (70%)								01	○
		CPCS8.0JA	99	22	7.188 (100%)	7.269 (90%)	8	12	16	20	01	○
		CPCS8.0JB	99	22	7.229 (95%)	7.310 (85%)	8	12	16	20	01	○
		CPCS8.0JC	99	22	7.269 (90%)	7.350 (80%)	8	12	16	20	01	○
		CPCS8.0JD	99	22	7.310 (85%)	7.391 (75%)	8	12	16	20	01	○
ST		CPCS8.0JE	99	22	7.350 (80%)	7.432 (70%)	8	12	16	20	01	○
		CPCS8.0JF	99	22	7.391 (75%)	7.472 (65%)	8	12	16	20	01	○
		CPCS8.0JM	set of 5pcs. CPCS8.0JB (95%) ~ CPCS8.0JF (65%)								01	○
		CPCS8.0JS	set of 5pcs. CPCS8.0JA (100%) ~ CPCS8.0JE (70%)								01	○
		CPCS9.0NA	110	27.5	7.647 (100%)	7.782 (90%)	10	13.5	18	22.5	01	○
		CPCS9.0NB	110	27.5	7.714 (95%)	7.850 (85%)	10	13.5	18	22.5	01	○
		CPCS9.0NC	110	27.5	7.782 (90%)	7.917 (80%)	10	13.5	18	22.5	01	○
CARBIDE		CPCS9.0ND	110	27.5	7.850 (85%)	7.985 (75%)	10	13.5	18	22.5	01	○
		CPCS9.0NE	110	27.5	7.917 (80%)	8.053 (70%)	10	13.5	18	22.5	01	○
		CPCS9.0NF	110	27.5	7.985 (75%)	8.120 (65%)	10	13.5	18	22.5	01	○
		CPCS9.0NM	set of 5pcs. CPCS9.0NB (95%) ~ CPCS9.0NF (65%)								01	○
LONG		CPCS9.0NS	set of 5pcs. CPCS9.0NA (100%) ~ CPCS9.0NE (70%)								01	○
		CPCS9.0MA	110	27.5	7.917 (100%)	8.026 (90%)	10	13.5	18	22.5	01	○
		CPCS9.0MB	110	27.5	7.972 (95%)	8.080 (85%)	10	13.5	18	22.5	01	○
		CPCS9.0MC	110	27.5	8.026 (90%)	8.134 (80%)	10	13.5	18	22.5	01	○
		CPCS9.0MD	110	27.5	8.080 (85%)	8.188 (75%)	10	13.5	18	22.5	01	○
		CPCS9.0ME	110	27.5	8.134 (80%)	8.242 (70%)	10	13.5	18	22.5	01	○
		CPCS9.0MF	110	27.5	8.188 (75%)	8.296 (65%)	10	13.5	18	22.5	01	○
EG (STI)		CPCS9.0MM	set of 5pcs. CPCS9.0MB (95%) ~ CPCS9.0MF (65%)								01	○
		CPCS9.0MS	set of 5pcs. CPCS9.0MA (100%) ~ CPCS9.0ME (70%)								01	○
		CPCS9.0JA	110	27.5	8.188 (100%)	8.269 (90%)	10	13.5	18	22.5	01	○
		CPCS9.0JB	110	27.5	8.229 (95%)	8.310 (85%)	10	13.5	18	22.5	01	○
		CPCS9.0JC	110	27.5	8.269 (90%)	8.350 (80%)	10	13.5	18	22.5	01	○
		CPCS9.0JD	110	27.5	8.310 (85%)	8.391 (75%)	10	13.5	18	22.5	01	○
		CPCS9.0JE	110	27.5	8.350 (80%)	8.432 (70%)	10	13.5	18	22.5	01	○
		CPCS9.0JF	110	27.5	8.391 (75%)	8.472 (65%)	10	13.5	18	22.5	01	○
		CPCS9.0JM	set of 5pcs. CPCS9.0JB (95%) ~ CPCS9.0JF (65%)								01	○
		CPCS9.0JS	set of 5pcs. CPCS9.0JA (100%) ~ CPCS9.0JE (70%)								01	○
		CPCS0100A	110	27.5	8.376 (100%)	8.538 (90%)	10	15	20	25	01	○
		CPCS0100B	110	27.5	8.457 (95%)	8.620 (85%)	10	15	20	25	01	○
		CPCS0100C	110	27.5	8.538 (90%)	8.701 (80%)	10	15	20	25	01	○
		CPCS0100D	110	27.5	8.620 (85%)	8.782 (75%)	10	15	20	25	01	○
		CPCS0100E	110	27.5	8.701 (80%)	8.863 (70%)	10	15	20	25	01	○
		CPCS0100F	110	27.5	8.782 (75%)	8.944 (65%)	10	15	20	25	01	○
		CPCS0100M	set of 5pcs. CPCS0100B (95%) ~ CPCS0100F (65%)								01	○
		CPCS0100S	set of 5pcs. CPCS0100A (100%) ~ CPCS0100E (70%)								01	○

M-MF	Code	LF (mm)	L (mm)	D1 (Thread engagement ratio)	D2 (Thread engagement ratio)	DCON (mm)	L1 (mm)	L2 (mm)	L3 (mm)	Type	Stock	
YMW												Intro
M10X1.25	CPCS010NA	110	27.5	8.647 (100%)	8.782 (90%)	10	15	20	25	01	○	
	CPCS010NB	110	27.5	8.714 (95%)	8.850 (85%)	10	15	20	25	01	○	SP
	CPCS010NC	110	27.5	8.782 (90%)	8.917 (80%)	10	15	20	25	01	○	
	CPCS010ND	110	27.5	8.850 (85%)	8.985 (75%)	10	15	20	25	01	○	
	CPCS010NE	110	27.5	8.917 (80%)	9.053 (70%)	10	15	20	25	01	○	SL
	CPCS010NF	110	27.5	8.985 (75%)	9.120 (65%)	10	15	20	25	01	○	
	CPCS010NM	set of 5pcs. CPCS010NB (95%) ~ CPCS010NF (65%)									01	○
CPCS010NS	set of 5pcs. CPCS010NA (100%) ~ CPCS010NE (70%)									01	○	
M10X1	CPCS010MA	110	27.5	8.917 (100%)	9.026 (90%)	10	15	20	25	01	○	PO
	CPCS010MB	110	27.5	8.972 (95%)	9.080 (85%)	10	15	20	25	01	○	
	CPCS010MC	110	27.5	9.026 (90%)	9.134 (80%)	10	15	20	25	01	○	
	CPCS010MD	110	27.5	9.080 (85%)	9.188 (75%)	10	15	20	25	01	○	
	CPCS010ME	110	27.5	9.134 (80%)	9.242 (70%)	10	15	20	25	01	○	ST
	CPCS010MF	110	27.5	9.188 (75%)	9.296 (65%)	10	15	20	25	01	○	
	CPCS010MM	set of 5pcs. CPCS010MB (95%) ~ CPCS010MF (65%)									01	○
CPCS010MS	set of 5pcs. CPCS010MA (100%) ~ CPCS010ME (70%)									01	○	
M10X0.75	CPCS010JA	110	27.5	9.188 (100%)	9.269 (90%)	10	15	20	25	01	○	ROLL
	CPCS010JB	110	27.5	9.229 (95%)	9.310 (85%)	10	15	20	25	01	○	
	CPCS010JC	110	27.5	9.269 (90%)	9.350 (80%)	10	15	20	25	01	○	
	CPCS010JD	110	27.5	9.310 (85%)	9.391 (75%)	10	15	20	25	01	○	CARBIDE
	CPCS010JE	110	27.5	9.350 (80%)	9.432 (70%)	10	15	20	25	01	○	
	CPCS010JF	110	27.5	9.391 (75%)	9.472 (65%)	10	15	20	25	01	○	
	CPCS010JM	set of 5pcs. CPCS010JB (95%) ~ CPCS010JF (65%)									01	○
CPCS010JS	set of 5pcs. CPCS010JA (100%) ~ CPCS010JE (70%)									01	○	LONG
M11X1.5	CPCS0110A	121	33	9.376 (100%)	9.538 (90%)	12	16.5	22	27.5	01	○	
	CPCS0110B	121	33	9.457 (95%)	9.620 (85%)	12	16.5	22	27.5	01	○	
	CPCS0110C	121	33	9.538 (90%)	9.701 (80%)	12	16.5	22	27.5	01	○	HAND TAPS
	CPCS0110D	121	33	9.620 (85%)	9.782 (75%)	12	16.5	22	27.5	01	○	
	CPCS0110E	121	33	9.701 (80%)	9.863 (70%)	12	16.5	22	27.5	01	○	
	CPCS0110F	121	33	9.782 (75%)	9.944 (65%)	12	16.5	22	27.5	01	○	
	CPCS0110M	set of 5pcs. CPCS0110B (95%) ~ CPCS0110F (65%)									01	○
CPCS0110S	set of 5pcs. CPCS0110A (100%) ~ CPCS0110E (70%)									01	○	
M11X1	CPCS011MA	121	33	9.917 (100%)	10.026 (90%)	12	16.5	22	27.5	01	○	SPECIAL THREADS, GAUGES YMW
	CPCS011MB	121	33	9.972 (95%)	10.080 (85%)	12	16.5	22	27.5	01	○	
	CPCS011MC	121	33	10.026 (90%)	10.134 (80%)	12	16.5	22	27.5	01	○	
	CPCS011MD	121	33	10.080 (85%)	10.188 (75%)	12	16.5	22	27.5	01	○	
	CPCS011ME	121	33	10.134 (80%)	10.242 (70%)	12	16.5	22	27.5	01	○	THREAD MILLS
	CPCS011MF	121	33	10.188 (75%)	10.296 (65%)	12	16.5	22	27.5	01	○	
	CPCS011MM	set of 5pcs. CPCS011MB (95%) ~ CPCS011MF (65%)									01	○
CPCS011MS	set of 5pcs. CPCS011MA (100%) ~ CPCS011ME (70%)									01	○	
M11X0.75	CPCS011JA	121	33	10.188 (100%)	10.269 (90%)	12	16.5	22	27.5	01	○	DIES
	CPCS011JB	121	33	10.229 (95%)	10.310 (85%)	12	16.5	22	27.5	01	○	
	CPCS011JC	121	33	10.269 (90%)	10.350 (80%)	12	16.5	22	27.5	01	○	
	CPCS011JD	121	33	10.310 (85%)	10.391 (75%)	12	16.5	22	27.5	01	○	
	CPCS011JE	121	33	10.350 (80%)	10.432 (70%)	12	16.5	22	27.5	01	○	CENTER DRILLS
	CPCS011JF	121	33	10.391 (75%)	10.472 (65%)	12	16.5	22	27.5	01	○	
	CPCS011JM	set of 5pcs. CPCS011JB (95%) ~ CPCS011JF (65%)									01	○
CPCS011JS	set of 5pcs. CPCS011JA (100%) ~ CPCS011JE (70%)									01	○	

Technical info

Special Threads, Gauges

Intro	M-MF	Code	LF (mm)	L (mm)	D1 (Thread engagement ratio)	D2 (Thread engagement ratio)	DCON (mm)	L1 (mm)	L2 (mm)	L3 (mm)	Type	Stock	
	YMW												
SP	M12X1.75	CPCS012PA	121	33	10.105 (100%)	10.295 (90%)	12	18	24	30	01	○	
		CPCS012PB	121	33	10.200 (95%)	10.390 (85%)	12	18	24	30	01	○	
		CPCS012PC	121	33	10.295 (90%)	10.484 (80%)	12	18	24	30	01	○	
		CPCS012PD	121	33	10.390 (85%)	10.579 (75%)	12	18	24	30	01	○	
		CPCS012PE	121	33	10.484 (80%)	10.674 (70%)	12	18	24	30	01	○	
		CPCS012PF	121	33	10.579 (75%)	10.769 (65%)	12	18	24	30	01	○	
		CPCS012PM	set of 5pcs. CPCS012PB (95%) ~ CPCS012PF (65%)									01	○
	CPCS012PS	set of 5pcs. CPCS012PA (100%) ~ CPCS012PE (70%)									01	○	
PO	M12X1.5	CPCS0120A	121	33	10.376 (100%)	10.538 (90%)	12	18	24	30	01	○	
		CPCS0120B	121	33	10.457 (95%)	10.620 (85%)	12	18	24	30	01	○	
		CPCS0120C	121	33	10.538 (90%)	10.701 (80%)	12	18	24	30	01	○	
CPCS0120D		121	33	10.620 (85%)	10.782 (75%)	12	18	24	30	01	○		
CPCS0120E		121	33	10.701 (80%)	10.863 (70%)	12	18	24	30	01	○		
CPCS0120F		121	33	10.782 (75%)	10.944 (65%)	12	18	24	30	01	○		
CPCS0120M		set of 5pcs. CPCS0120B (95%) ~ CPCS0120F (65%)									01	○	
CPCS0120S		set of 5pcs. CPCS0120A (100%) ~ CPCS0120E (70%)									01	○	
ROLL		M12X1.25	CPCS012NA	121	33	10.647 (100%)	10.782 (90%)	12	18	24	30	01	○
	CPCS012NB		121	33	10.714 (95%)	10.850 (85%)	12	18	24	30	01	○	
	CPCS012NC		121	33	10.782 (90%)	10.917 (80%)	12	18	24	30	01	○	
	CPCS012ND		121	33	10.850 (85%)	10.985 (75%)	12	18	24	30	01	○	
	CPCS012NE		121	33	10.917 (80%)	11.053 (70%)	12	18	24	30	01	○	
	CPCS012NF		121	33	10.985 (75%)	11.120 (65%)	12	18	24	30	01	○	
	CPCS012NM		set of 5pcs. CPCS012NB (95%) ~ CPCS012NF (65%)									01	○
CPCS012NS	set of 5pcs. CPCS012NA (100%) ~ CPCS012NE (70%)									01	○		
CARBIDE	M12X1		CPCS012MA	121	33	10.917 (100%)	11.026 (90%)	12	18	24	30	01	○
		CPCS012MB	121	33	10.972 (95%)	11.080 (85%)	12	18	24	30	01	○	
		CPCS012MC	121	33	11.026 (90%)	11.134 (80%)	12	18	24	30	01	○	
		CPCS012MD	121	33	11.080 (85%)	11.188 (75%)	12	18	24	30	01	○	
		CPCS012ME	121	33	11.134 (80%)	11.242 (70%)	12	18	24	30	01	○	
		CPCS012MF	121	33	11.188 (75%)	11.296 (65%)	12	18	24	30	01	○	
		CPCS012MM	set of 5pcs. CPCS012MB (95%) ~ CPCS012MF (65%)									01	○
CPCS012MS		set of 5pcs. CPCS012MA (100%) ~ CPCS012ME (70%)									01	○	
LONG		No.2-56UNC	CPCSUN2EA	41.5	5.5	1.695 (100%)	1.742 (90%)	3	3.3	4.4	5.5	01	○
	CPCSUN2EB		41.5	5.5	1.718 (95%)	1.767 (85%)	3	3.3	4.4	5.5	01	○	
	CPCSUN2EC		41.5	5.5	1.742 (90%)	1.791 (80%)	3	3.3	4.4	5.5	01	○	
	CPCSUN2ED		41.5	5.5	1.767 (85%)	1.816 (75%)	3	3.3	4.4	5.5	01	○	
	CPCSUN2EE		41.5	5.5	1.791 (80%)	1.840 (70%)	3	3.3	4.4	5.5	01	○	
	CPCSUN2EF		41.5	5.5	1.816 (75%)	1.865 (65%)	3	3.3	4.4	5.5	01	○	
	CPCSUN2EM		set of 5pcs. CPCSUN2EB (95%) ~ CPCSUN2EF (65%)									01	○
CPCSUN2ES	set of 5pcs. CPCSUN2EA (100%) ~ CPCSUN2EE (70%)									01	○		
HAND TAPS	No.2-56UNC		CPCSUN2EA	41.5	5.5	1.695 (100%)	1.742 (90%)	3	3.3	4.4	5.5	01	○
		CPCSUN2EB	41.5	5.5	1.718 (95%)	1.767 (85%)	3	3.3	4.4	5.5	01	○	
		CPCSUN2EC	41.5	5.5	1.742 (90%)	1.791 (80%)	3	3.3	4.4	5.5	01	○	
		CPCSUN2ED	41.5	5.5	1.767 (85%)	1.816 (75%)	3	3.3	4.4	5.5	01	○	
		CPCSUN2EE	41.5	5.5	1.791 (80%)	1.840 (70%)	3	3.3	4.4	5.5	01	○	
		CPCSUN2EF	41.5	5.5	1.816 (75%)	1.865 (65%)	3	3.3	4.4	5.5	01	○	
		CPCSUN2EM	set of 5pcs. CPCSUN2EB (95%) ~ CPCSUN2EF (65%)									01	○
CPCSUN2ES		set of 5pcs. CPCSUN2EA (100%) ~ CPCSUN2EE (70%)									01	○	
EG (STI)		No.2-56UNC	CPCSUN2EA	41.5	5.5	1.695 (100%)	1.742 (90%)	3	3.3	4.4	5.5	01	○
	CPCSUN2EB		41.5	5.5	1.718 (95%)	1.767 (85%)	3	3.3	4.4	5.5	01	○	
	CPCSUN2EC		41.5	5.5	1.742 (90%)	1.791 (80%)	3	3.3	4.4	5.5	01	○	
	CPCSUN2ED		41.5	5.5	1.767 (85%)	1.816 (75%)	3	3.3	4.4	5.5	01	○	
	CPCSUN2EE		41.5	5.5	1.791 (80%)	1.840 (70%)	3	3.3	4.4	5.5	01	○	
	CPCSUN2EF		41.5	5.5	1.816 (75%)	1.865 (65%)	3	3.3	4.4	5.5	01	○	
	CPCSUN2EM		set of 5pcs. CPCSUN2EB (95%) ~ CPCSUN2EF (65%)									01	○
CPCSUN2ES	set of 5pcs. CPCSUN2EA (100%) ~ CPCSUN2EE (70%)									01	○		
SPECIAL THREADS, GAUGES YMW	UNC-UNF		Code	LF (mm)	L (mm)	D1 (Thread engagement ratio)	D2 (Thread engagement ratio)	DCON (mm)	L1 (mm)	L2 (mm)	L3 (mm)	Type	Stock
	YMW												
	THREAD MILLS	No.2-56UNC	CPCSUN2EA	41.5	5.5	1.695 (100%)	1.742 (90%)	3	3.3	4.4	5.5	01	○
			CPCSUN2EB	41.5	5.5	1.718 (95%)	1.767 (85%)	3	3.3	4.4	5.5	01	○
			CPCSUN2EC	41.5	5.5	1.742 (90%)	1.791 (80%)	3	3.3	4.4	5.5	01	○
			CPCSUN2ED	41.5	5.5	1.767 (85%)	1.816 (75%)	3	3.3	4.4	5.5	01	○
			CPCSUN2EE	41.5	5.5	1.791 (80%)	1.840 (70%)	3	3.3	4.4	5.5	01	○
CPCSUN2EF			41.5	5.5	1.816 (75%)	1.865 (65%)	3	3.3	4.4	5.5	01	○	
CPCSUN2EM			set of 5pcs. CPCSUN2EB (95%) ~ CPCSUN2EF (65%)									01	○
CPCSUN2ES	set of 5pcs. CPCSUN2EA (100%) ~ CPCSUN2EE (70%)									01	○		
DIES	No.2-56UNC		CPCSUN2EA	41.5	5.5	1.695 (100%)	1.742 (90%)	3	3.3	4.4	5.5	01	○
		CPCSUN2EB	41.5	5.5	1.718 (95%)	1.767 (85%)	3	3.3	4.4	5.5	01	○	
		CPCSUN2EC	41.5	5.5	1.742 (90%)	1.791 (80%)	3	3.3	4.4	5.5	01	○	
		CPCSUN2ED	41.5	5.5	1.767 (85%)	1.816 (75%)	3	3.3	4.4	5.5	01	○	
		CPCSUN2EE	41.5	5.5	1.791 (80%)	1.840 (70%)	3	3.3	4.4	5.5	01	○	
		CPCSUN2EF	41.5	5.5	1.816 (75%)	1.865 (65%)	3	3.3	4.4	5.5	01	○	
		CPCSUN2EM	set of 5pcs. CPCSUN2EB (95%) ~ CPCSUN2EF (65%)									01	○
CPCSUN2ES		set of 5pcs. CPCSUN2EA (100%) ~ CPCSUN2EE (70%)									01	○	
CENTER DRILLS		No.2-56UNC	CPCSUN2EA	41.5	5.5	1.695 (100%)	1.742 (90%)	3	3.3	4.4	5.5	01	○
	CPCSUN2EB		41.5	5.5	1.718 (95%)	1.767 (85%)	3	3.3	4.4	5.5	01	○	
	CPCSUN2EC		41.5	5.5	1.742 (90%)	1.791 (80%)	3	3.3	4.4	5.5	01	○	
	CPCSUN2ED		41.5	5.5	1.767 (85%)	1.816 (75%)	3	3.3	4.4	5.5	01	○	
	CPCSUN2EE		41.5	5.5	1.791 (80%)	1.840 (70%)	3	3.3	4.4	5.5	01	○	
	CPCSUN2EF		41.5	5.5	1.816 (75%)	1.865 (65%)	3	3.3	4.4	5.5	01	○	
	CPCSUN2EM		set of 5pcs. CPCSUN2EB (95%) ~ CPCSUN2EF (65%)									01	○
CPCSUN2ES	set of 5pcs. CPCSUN2EA (100%) ~ CPCSUN2EE (70%)									01	○		
TECHNICAL INFO	No.2-56UNC		CPCSUN2EA	41.5	5.5	1.695 (100%)	1.742 (90%)	3	3.3	4.4	5.5	01	○
		CPCSUN2EB	41.5	5.5	1.718 (95%)	1.767 (85%)	3	3.3	4.4	5.5	01	○	
		CPCSUN2EC	41.5	5.5	1.742 (90%)	1.791 (80%)	3	3.3	4.4	5.5	01	○	
		CPCSUN2ED	41.5	5.5	1.767 (85%)	1.816 (75%)	3	3.3	4.4	5.5	01	○	
		CPCSUN2EE	41.5	5.5	1.791 (80%)	1.840 (70%)	3	3.3	4.4	5.5	01	○	
		CPCSUN2EF	41.5	5.5	1.816 (75%)	1.865 (65%)	3	3.3	4.4	5.5	01	○	
		CPCSUN2EM	set of 5pcs. CPCSUN2EB (95%) ~ CPCSUN2EF (65%)									01	○
CPCSUN2ES		set of 5pcs. CPCSUN2EA (100%) ~ CPCSUN2EE (70%)									01	○	

UNC-UNF	Code	LF (mm)	L (mm)	D1 (Thread engagement ratio)	D2 (Thread engagement ratio)	DCON (mm)	L1 (mm)	L2 (mm)	L3 (mm)	Type	Stock	
YMW												Intro
No.2-64UNF	CPCSUN2DA	41.5	5.5	1.756 (100%)	1.797 (90%)	3	3.3	4.4	5.5	01	○	
	CPCSUN2DB	41.5	5.5	1.776 (95%)	1.819 (85%)	3	3.3	4.4	5.5	01	○	SP
	CPCSUN2DC	41.5	5.5	1.797 (90%)	1.840 (80%)	3	3.3	4.4	5.5	01	○	
	CPCSUN2DD	41.5	5.5	1.819 (85%)	1.862 (75%)	3	3.3	4.4	5.5	01	○	
	CPCSUN2DE	41.5	5.5	1.840 (80%)	1.883 (70%)	3	3.3	4.4	5.5	01	○	SL
	CPCSUN2DF	41.5	5.5	1.862 (75%)	1.905 (65%)	3	3.3	4.4	5.5	01	○	
	CPCSUN2DM	set of 5pcs. CPCSUN2DB (95%) ~ CPCSUN2DF (65%)									01	○
CPCSUN2DS	set of 5pcs. CPCSUN2DA (100%) ~ CPCSUN2DE (70%)									01	○	
No.3-48UNC	CPCSUN3FA	45	7.5	1.941 (100%)	1.999 (90%)	3	3.8	5	6.3	01	○	PO
	CPCSUN3FB	45	7.5	1.971 (95%)	2.028 (85%)	3	3.8	5	6.3	01	○	
	CPCSUN3FC	45	7.5	1.999 (90%)	2.057 (80%)	3	3.8	5	6.3	01	○	
	CPCSUN3FD	45	7.5	2.028 (85%)	2.085 (75%)	3	3.8	5	6.3	01	○	
	CPCSUN3FE	45	7.5	2.057 (80%)	2.114 (70%)	3	3.8	5	6.3	01	○	ST
	CPCSUN3FF	45	7.5	2.085 (75%)	2.143 (65%)	3	3.8	5	6.3	01	○	
	CPCSUN3FM	set of 5pcs. CPCSUN3FB (95%) ~ CPCSUN3FF (65%)									01	○
CPCSUN3FS	set of 5pcs. CPCSUN3FA (100%) ~ CPCSUN3FE (70%)									01	○	
No.3-56UNF	CPCSUN3EA	45	7.5	2.025 (100%)	2.073 (90%)	3	3.8	5	6.3	01	○	ROLL
	CPCSUN3EB	45	7.5	2.049 (95%)	2.098 (85%)	3	3.8	5	6.3	01	○	
	CPCSUN3EC	45	7.5	2.073 (90%)	2.122 (80%)	3	3.8	5	6.3	01	○	
	CPCSUN3ED	45	7.5	2.098 (85%)	2.147 (75%)	3	3.8	5	6.3	01	○	CARBIDE
	CPCSUN3EE	45	7.5	2.122 (80%)	2.171 (70%)	3	3.8	5	6.3	01	○	
	CPCSUN3EF	45	7.5	2.147 (75%)	2.196 (65%)	3	3.8	5	6.3	01	○	
	CPCSUN3EM	set of 5pcs. CPCSUN3EB (95%) ~ CPCSUN3EF (65%)									01	○
CPCSUN3ES	set of 5pcs. CPCSUN3EA (100%) ~ CPCSUN3EE (70%)									01	○	LONG
No.4-40UNC	CPCSUN4HA	45	7.5	2.157 (100%)	2.226 (90%)	3	4.3	5.7	7.1	01	○	
	CPCSUN4HB	45	7.5	2.192 (95%)	2.261 (85%)	3	4.3	5.7	7.1	01	○	
	CPCSUN4HC	45	7.5	2.226 (90%)	2.295 (80%)	3	4.3	5.7	7.1	01	○	HAND TAPS
	CPCSUN4HD	45	7.5	2.261 (85%)	2.329 (75%)	3	4.3	5.7	7.1	01	○	
	CPCSUN4HE	45	7.5	2.295 (80%)	2.364 (70%)	3	4.3	5.7	7.1	01	○	
	CPCSUN4HF	45	7.5	2.329 (75%)	2.398 (65%)	3	4.3	5.7	7.1	01	○	
	CPCSUN4HM	set of 5pcs. CPCSUN4HB (95%) ~ CPCSUN4HF (65%)									01	○
CPCSUN4HS	set of 5pcs. CPCSUN4HA (100%) ~ CPCSUN4HE (70%)									01	○	
No.4-48UNF	CPCSUN4FA	45	7.5	2.271 (100%)	2.329 (90%)	3	4.3	5.7	7.1	01	○	
	CPCSUN4FB	45	7.5	2.301 (95%)	2.358 (85%)	3	4.3	5.7	7.1	01	○	SPECIAL THREADS, GAUGES YMW
	CPCSUN4FC	45	7.5	2.329 (90%)	2.387 (80%)	3	4.3	5.7	7.1	01	○	
	CPCSUN4FD	45	7.5	2.358 (85%)	2.415 (75%)	3	4.3	5.7	7.1	01	○	
	CPCSUN4FE	45	7.5	2.387 (80%)	2.444 (70%)	3	4.3	5.7	7.1	01	○	THREAD MILLS
	CPCSUN4FF	45	7.5	2.415 (75%)	2.473 (65%)	3	4.3	5.7	7.1	01	○	
	CPCSUN4FM	set of 5pcs. CPCSUN4FB (95%) ~ CPCSUN4FF (65%)									01	○
CPCSUN4FS	set of 5pcs. CPCSUN4FA (100%) ~ CPCSUN4FE (70%)									01	○	
No.5-40UNC	CPCSUN5HA	49	9	2.487 (100%)	2.556 (90%)	4	4.8	6.4	7.9	01	○	DIES
	CPCSUN5HB	49	9	2.522 (95%)	2.591 (85%)	4	4.8	6.4	7.9	01	○	
	CPCSUN5HC	49	9	2.556 (90%)	2.625 (80%)	4	4.8	6.4	7.9	01	○	
	CPCSUN5HD	49	9	2.591 (85%)	2.659 (75%)	4	4.8	6.4	7.9	01	○	
	CPCSUN5HE	49	9	2.625 (80%)	2.694 (70%)	4	4.8	6.4	7.9	01	○	CENTER DRILLS
	CPCSUN5HF	49	9	2.659 (75%)	2.728 (65%)	4	4.8	6.4	7.9	01	○	
	CPCSUN5HM	set of 5pcs. CPCSUN5HB (95%) ~ CPCSUN5HF (65%)									01	○
CPCSUN5HS	set of 5pcs. CPCSUN5HA (100%) ~ CPCSUN5HE (70%)									01	○	

Technical info

Special Threads, Gauges

Intro

UNC-UNF

Code

LF
(mm)

L
(mm)

D1
(Thread engagement ratio)

D2
(Thread engagement ratio)

DCON
(mm)

L1
(mm)

L2
(mm)

L3
(mm)

Type

Stock

YMW

SP

No.5-44UNF

SL

PO

ST

No.6-32UNC

ROLL

CARBIDE

No.6-40UNF

LONG

HAND
TAPS

No.8-32UNC

EG (STI)

SPECIAL
THREADS,
GAUGES
YMW

No.8-36UNF

THREAD
MILLS

DIES

No.10-24UNC

CENTER
DRILLS

Technical
info

	CPCSUN5GA	49	9	2.551 (100%)	2.613 (90%)	4	4.8	6.4	7.9	01	○
	CPCSUN5GB	49	9	2.581 (95%)	2.644 (85%)	4	4.8	6.4	7.9	01	○
	CPCSUN5GC	49	9	2.613 (90%)	2.675 (80%)	4	4.8	6.4	7.9	01	○
	CPCSUN5GD	49	9	2.644 (85%)	2.706 (75%)	4	4.8	6.4	7.9	01	○
	CPCSUN5GE	49	9	2.675 (80%)	2.738 (70%)	4	4.8	6.4	7.9	01	○
	CPCSUN5GF	49	9	2.706 (75%)	2.769 (65%)	4	4.8	6.4	7.9	01	○
	CPCSUN5GM	set of 5pcs. CPCSUN5GB (95%) ~ CPCSUN5GF (65%)								01	○
	CPCSUN5GS	set of 5pcs. CPCSUN5GA (100%) ~ CPCSUN5GE (70%)								01	○
	CPCSUN6JA	49	9	2.642 (100%)	2.732 (90%)	4	5.3	7	8.8	01	○
	CPCSUN6JB	49	9	2.689 (95%)	2.775 (85%)	4	5.3	7	8.8	01	○
	CPCSUN6JC	49	9	2.732 (90%)	2.818 (80%)	4	5.3	7	8.8	01	○
	CPCSUN6JD	49	9	2.775 (85%)	2.861 (75%)	4	5.3	7	8.8	01	○
	CPCSUN6JE	49	9	2.818 (80%)	2.903 (70%)	4	5.3	7	8.8	01	○
	CPCSUN6JF	49	9	2.861 (75%)	2.946 (65%)	4	5.3	7	8.8	01	○
	CPCSUN6JM	set of 5pcs. CPCSUN6JB (95%) ~ CPCSUN6JF (65%)								01	○
	CPCSUN6JS	set of 5pcs. CPCSUN6JA (100%) ~ CPCSUN6JE (70%)								01	○
	CPCSUN6HA	49	9	2.820 (100%)	2.886 (90%)	4	5.3	7	8.8	01	○
	CPCSUN6HB	49	9	2.852 (95%)	2.921 (85%)	4	5.3	7	8.8	01	○
	CPCSUN6HC	49	9	2.886 (90%)	2.955 (80%)	4	5.3	7	8.8	01	○
	CPCSUN6HD	49	9	2.921 (85%)	2.989 (75%)	4	5.3	7	8.8	01	○
	CPCSUN6HE	49	9	2.955 (80%)	3.024 (70%)	4	5.3	7	8.8	01	○
	CPCSUN6HF	49	9	2.989 (75%)	3.058 (65%)	4	5.3	7	8.8	01	○
	CPCSUN6HM	set of 5pcs. CPCSUN6HB (95%) ~ CPCSUN6HF (65%)								01	○
	CPCSUN6HS	set of 5pcs. CPCSUN6HA (100%) ~ CPCSUN6HE (70%)								01	○
	CPCSUN8JA	57	11	3.302 (100%)	3.394 (90%)	5	6.3	8.3	10.4	01	○
	CPCSUN8JB	57	11	3.351 (95%)	3.437 (85%)	5	6.3	8.3	10.4	01	○
	CPCSUN8JC	57	11	3.394 (90%)	3.480 (80%)	5	6.3	8.3	10.4	01	○
	CPCSUN8JD	57	11	3.437 (85%)	3.523 (75%)	5	6.3	8.3	10.4	01	○
	CPCSUN8JE	57	11	3.480 (80%)	3.565 (70%)	5	6.3	8.3	10.4	01	○
	CPCSUN8JF	57	11	3.523 (75%)	3.608 (65%)	5	6.3	8.3	10.4	01	○
	CPCSUN8JM	set of 5pcs. CPCSUN8JB (95%) ~ CPCSUN8JF (65%)								01	○
	CPCSUN8JS	set of 5pcs. CPCSUN8JA (100%) ~ CPCSUN8JE (70%)								01	○
	CPCSUN8IA	57	11	3.404 (100%)	3.480 (90%)	5	6.3	8.3	10.4	01	○
	CPCSUN8IB	57	11	3.441 (95%)	3.518 (85%)	5	6.3	8.3	10.4	01	○
	CPCSUN8IC	57	11	3.480 (90%)	3.556 (80%)	5	6.3	8.3	10.4	01	○
	CPCSUN8ID	57	11	3.518 (85%)	3.594 (75%)	5	6.3	8.3	10.4	01	○
	CPCSUN8IE	57	11	3.556 (80%)	3.632 (70%)	5	6.3	8.3	10.4	01	○
	CPCSUN8IF	57	11	3.594 (75%)	3.671 (65%)	5	6.3	8.3	10.4	01	○
	CPCSUN8IM	set of 5pcs. CPCSUN8IB (95%) ~ CPCSUN8IF (65%)								01	○
	CPCSUN8IS	set of 5pcs. CPCSUN8IA (100%) ~ CPCSUN8IE (70%)								01	○
	CPCSUNAMA	65	14	3.683 (100%)	3.795 (90%)	5.5	7.2	9.7	12.1	01	○
	CPCSUNAMB	65	14	3.738 (95%)	3.852 (85%)	5.5	7.2	9.7	12.1	01	○
	CPCSUNAMC	65	14	3.795 (90%)	3.909 (80%)	5.5	7.2	9.7	12.1	01	○
	CPCSUNAMD	65	14	3.852 (85%)	3.967 (75%)	5.5	7.2	9.7	12.1	01	○
	CPCSUNAME	65	14	3.909 (80%)	4.024 (70%)	5.5	7.2	9.7	12.1	01	○
	CPCSUNAMF	65	14	3.967 (75%)	4.081 (65%)	5.5	7.2	9.7	12.1	01	○
	CPCSUNAMM	set of 5pcs. CPCSUNAMB (95%) ~ CPCSUNAMF (65%)								01	○
	CPCSUNAMS	set of 5pcs. CPCSUNAMA (100%) ~ CPCSUNAME (70%)								01	○

UNC-UNF	Code	LF (mm)	L (mm)	D1 (Thread engagement ratio)	D2 (Thread engagement ratio)	DCON (mm)	L1 (mm)	L2 (mm)	L3 (mm)	Type	Stock	
YMW												Intro
No.10-32UNF	CPCSUNAJA	65	14	3.963 (100%)	4.053 (90%)	5.5	7.2	9.7	12.1	01	○	
	CPCSUNAJB	65	14	4.010 (95%)	4.096 (85%)	5.5	7.2	9.7	12.1	01	○	SP
	CPCSUNAJC	65	14	4.053 (90%)	4.139 (80%)	5.5	7.2	9.7	12.1	01	○	
	CPCSUNAJD	65	14	4.096 (85%)	4.182 (75%)	5.5	7.2	9.7	12.1	01	○	
	CPCSUNAJE	65	14	4.139 (80%)	4.224 (70%)	5.5	7.2	9.7	12.1	01	○	SL
	CPCSUNAJF	65	14	4.182 (75%)	4.267 (65%)	5.5	7.2	9.7	12.1	01	○	
	CPCSUNAJM	set of 5pcs. CPCSUNAJB (95%) ~ CPCSUNAJF (65%)									01	○
CPCSUNAJN	set of 5pcs. CPCSUNAJA (100%) ~ CPCSUNAJE (70%)									01	○	
No.12-24UNC	CPCSUNCMA	65	14	4.344 (100%)	4.455 (90%)	5.5	8.2	11	13.7	01	○	PO
	CPCSUNCMB	65	14	4.398 (95%)	4.512 (85%)	5.5	8.2	11	13.7	01	○	
	CPCSUNCMC	65	14	4.455 (90%)	4.569 (80%)	5.5	8.2	11	13.7	01	○	
	CPCSUNCMD	65	14	4.512 (85%)	4.627 (75%)	5.5	8.2	11	13.7	01	○	
	CPCSUNCME	65	14	4.569 (80%)	4.684 (70%)	5.5	8.2	11	13.7	01	○	ST
	CPCSUNCMF	65	14	4.627 (75%)	4.741 (65%)	5.5	8.2	11	13.7	01	○	
	CPCSUNCMM	set of 5pcs. CPCSUNCMB (95%) ~ CPCSUNCMF (65%)									01	○
CPCSUNCMS	set of 5pcs. CPCSUNCMA (100%) ~ CPCSUNCME (70%)									01	○	
No.12-28UNF	CPCSUNCKA	65	14	4.496 (100%)	4.602 (90%)	5.5	8.2	11	13.7	01	○	ROLL
	CPCSUNCKB	65	14	4.553 (95%)	4.651 (85%)	5.5	8.2	11	13.7	01	○	
	CPCSUNCKC	65	14	4.602 (90%)	4.700 (80%)	5.5	8.2	11	13.7	01	○	
	CPCSUNCKD	65	14	4.651 (85%)	4.749 (75%)	5.5	8.2	11	13.7	01	○	CARBIDE
	CPCSUNCKE	65	14	4.700 (80%)	4.799 (70%)	5.5	8.2	11	13.7	01	○	
	CPCSUNCKF	65	14	4.749 (75%)	4.848 (65%)	5.5	8.2	11	13.7	01	○	
	CPCSUNCKM	set of 5pcs. CPCSUNCKB (95%) ~ CPCSUNCKF (65%)									01	○
CPCSUNCKS	set of 5pcs. CPCSUNCKA (100%) ~ CPCSUNCKE (70%)									01	○	LONG
1/4-20UNC	CPCSU04NA	73	16.5	4.979 (100%)	5.113 (90%)	6	9.5	12.7	15.9	01	○	
	CPCSU04NB	73	16.5	5.044 (95%)	5.181 (85%)	6	9.5	12.7	15.9	01	○	
	CPCSU04NC	73	16.5	5.113 (90%)	5.250 (80%)	6	9.5	12.7	15.9	01	○	HAND TAPS
	CPCSU04ND	73	16.5	5.181 (85%)	5.319 (75%)	6	9.5	12.7	15.9	01	○	
	CPCSU04NE	73	16.5	5.250 (80%)	5.388 (70%)	6	9.5	12.7	15.9	01	○	
	CPCSU04NF	73	16.5	5.319 (75%)	5.456 (65%)	6	9.5	12.7	15.9	01	○	
	CPCSU04NM	set of 5pcs. CPCSU04NB (95%) ~ CPCSU04NF (65%)									01	○
CPCSU04NS	set of 5pcs. CPCSU04NA (100%) ~ CPCSU04NE (70%)									01	○	
1/4-28UNF	CPCSU04KA	73	16.5	5.360 (100%)	5.466 (90%)	6	9.5	12.7	15.9	01	○	
	CPCSU04KB	73	16.5	5.417 (95%)	5.515 (85%)	6	9.5	12.7	15.9	01	○	SPECIAL THREADS, GAUGES YMW
	CPCSU04KC	73	16.5	5.466 (90%)	5.564 (80%)	6	9.5	12.7	15.9	01	○	
	CPCSU04KD	73	16.5	5.515 (85%)	5.613 (75%)	6	9.5	12.7	15.9	01	○	
	CPCSU04KE	73	16.5	5.564 (80%)	5.663 (70%)	6	9.5	12.7	15.9	01	○	THREAD MILLS
	CPCSU04KF	73	16.5	5.613 (75%)	5.712 (65%)	6	9.5	12.7	15.9	01	○	
	CPCSU04KM	set of 5pcs. CPCSU04KB (95%) ~ CPCSU04KF (65%)									01	○
CPCSU04KS	set of 5pcs. CPCSU04KA (100%) ~ CPCSU04KE (70%)									01	○	
5/16-18UNC	CPCSU05OA	99	22	6.401 (100%)	6.563 (90%)	8	11.9	15.9	19.8	01	○	DIES
	CPCSU05OB	99	22	6.487 (95%)	6.639 (85%)	8	11.9	15.9	19.8	01	○	
	CPCSU05OC	99	22	6.563 (90%)	6.716 (80%)	8	11.9	15.9	19.8	01	○	
	CPCSU05OD	99	22	6.639 (85%)	6.792 (75%)	8	11.9	15.9	19.8	01	○	
	CPCSU05OE	99	22	6.716 (80%)	6.869 (70%)	8	11.9	15.9	19.8	01	○	CENTER DRILLS
	CPCSU05OF	99	22	6.792 (75%)	6.945 (65%)	8	11.9	15.9	19.8	01	○	
	CPCSU05OM	set of 5pcs. CPCSU05OB (95%) ~ CPCSU05OF (65%)									01	○
CPCSU05OS	set of 5pcs. CPCSU05OA (100%) ~ CPCSU05OE (70%)									01	○	

Technical info

Special Threads, Gauges

Intro

UNC-UNF

Code

LF
(mm)

L
(mm)

D1
(Thread engagement ratio)

D2
(Thread engagement ratio)

DCON
(mm)

L1
(mm)

L2
(mm)

L3
(mm)

Type

Stock

YMW

SP

5/16-24UNF

SL

PO

ST

3/8-16UNC

ROLL

CARBIDE

3/8-24UNF

LONG

HAND
TAPS

7/16-14UNC

EG (STI)

**SPECIAL
THREADS,
GAUGES
YMW**

7/16-20UNF

THREAD
MILLS

DIES

CENTER
DRILLS

1/2-13UNC

Technical
info

	Code	LF (mm)	L (mm)	D1 (Thread engagement ratio)	D2 (Thread engagement ratio)	DCON (mm)	L1 (mm)	L2 (mm)	L3 (mm)	Type	Stock
	YMW										
	CPCSU05MA	99	22	6.782 (100%)	6.907 (90%)	8	11.9	15.9	19.8	01	○
SP	CPCSU05MB	99	22	6.850 (95%)	6.964 (85%)	8	11.9	15.9	19.8	01	○
	CPCSU05MC	99	22	6.907 (90%)	7.021 (80%)	8	11.9	15.9	19.8	01	○
	CPCSU05MD	99	22	6.964 (85%)	7.079 (75%)	8	11.9	15.9	19.8	01	○
SL	CPCSU05ME	99	22	7.021 (80%)	7.136 (70%)	8	11.9	15.9	19.8	01	○
	CPCSU05MF	99	22	7.079 (75%)	7.193 (65%)	8	11.9	15.9	19.8	01	○
	CPCSU05MM	set of 5pcs. CPCSU05MB (95%) ~ CPCSU05MF (65%)								01	○
	CPCSU05MS	set of 5pcs. CPCSU05MA (100%) ~ CPCSU05ME (70%)								01	○
	CPCSU06PA	110	27.5	7.798 (100%)	7.978 (90%)	10	14.3	19.1	23.8	01	○
PO	CPCSU06PB	110	27.5	7.892 (95%)	8.064 (85%)	10	14.3	19.1	23.8	01	○
	CPCSU06PC	110	27.5	7.978 (90%)	8.150 (80%)	10	14.3	19.1	23.8	01	○
	CPCSU06PD	110	27.5	8.064 (85%)	8.236 (75%)	10	14.3	19.1	23.8	01	○
ST	CPCSU06PE	110	27.5	8.150 (80%)	8.322 (70%)	10	14.3	19.1	23.8	01	○
	CPCSU06PF	110	27.5	8.236 (75%)	8.408 (65%)	10	14.3	19.1	23.8	01	○
	CPCSU06PM	set of 5pcs. CPCSU06PB (95%) ~ CPCSU06PF (65%)								01	○
	CPCSU06PS	set of 5pcs. CPCSU06PA (100%) ~ CPCSU06PE (70%)								01	○
	CPCSU06MA	110	27.5	8.382 (100%)	8.494 (90%)	10	14.3	19.1	23.8	01	○
	CPCSU06MB	110	27.5	8.437 (95%)	8.551 (85%)	10	14.3	19.1	23.8	01	○
	CPCSU06MC	110	27.5	8.494 (90%)	8.608 (80%)	10	14.3	19.1	23.8	01	○
CARBIDE	CPCSU06MD	110	27.5	8.551 (85%)	8.666 (75%)	10	14.3	19.1	23.8	01	○
	CPCSU06ME	110	27.5	8.608 (80%)	8.723 (70%)	10	14.3	19.1	23.8	01	○
	CPCSU06MF	110	27.5	8.666 (75%)	8.780 (65%)	10	14.3	19.1	23.8	01	○
	CPCSU06MM	set of 5pcs. CPCSU06MB (95%) ~ CPCSU06MF (65%)								01	○
	CPCSU06MS	set of 5pcs. CPCSU06MA (100%) ~ CPCSU06ME (70%)								01	○
	CPCSU07QA	121	33	9.144 (100%)	9.345 (90%)	12	16.7	22.2	27.8	01	○
	CPCSU07QB	121	33	9.247 (95%)	9.443 (85%)	12	16.7	22.2	27.8	01	○
	CPCSU07QC	121	33	9.345 (90%)	9.542 (80%)	12	16.7	22.2	27.8	01	○
	CPCSU07QD	121	33	9.443 (85%)	9.640 (75%)	12	16.7	22.2	27.8	01	○
	CPCSU07QE	121	33	9.542 (80%)	9.738 (70%)	12	16.7	22.2	27.8	01	○
	CPCSU07QF	121	33	9.640 (75%)	9.836 (65%)	12	16.7	22.2	27.8	01	○
	CPCSU07QM	set of 5pcs. CPCSU07QB (95%) ~ CPCSU07QF (65%)								01	○
	CPCSU07QS	set of 5pcs. CPCSU07QA (100%) ~ CPCSU07QE (70%)								01	○
	CPCSU07NA	121	33	9.729 (100%)	9.876 (90%)	12	16.7	22.2	27.8	01	○
	CPCSU07NB	121	33	9.807 (95%)	9.944 (85%)	12	16.7	22.2	27.8	01	○
	CPCSU07NC	121	33	9.876 (90%)	10.013 (80%)	12	16.7	22.2	27.8	01	○
	CPCSU07ND	121	33	9.944 (85%)	10.082 (75%)	12	16.7	22.2	27.8	01	○
	CPCSU07NE	121	33	10.013 (80%)	10.151 (70%)	12	16.7	22.2	27.8	01	○
	CPCSU07NF	121	33	10.082 (75%)	10.219 (65%)	12	16.7	22.2	27.8	01	○
	CPCSU07NM	set of 5pcs. CPCSU07NB (95%) ~ CPCSU07NF (65%)								01	○
	CPCSU07NS	set of 5pcs. CPCSU07NA (100%) ~ CPCSU07NE (70%)								01	○
	CPCSU08RA	121	33	10.592 (100%)	10.796 (90%)	12	19.1	25.4	31.8	01	○
	CPCSU08RB	121	33	10.691 (95%)	10.902 (85%)	12	19.1	25.4	31.8	01	○
	CPCSU08RC	121	33	10.796 (90%)	11.008 (80%)	12	19.1	25.4	31.8	01	○
	CPCSU08RD	121	33	10.902 (85%)	11.114 (75%)	12	19.1	25.4	31.8	01	○
	CPCSU08RE	121	33	11.008 (80%)	11.219 (70%)	12	19.1	25.4	31.8	01	○
	CPCSU08RF	121	33	11.114 (75%)	11.325 (65%)	12	19.1	25.4	31.8	01	○
	CPCSU08RM	set of 5pcs. CPCSU08RB (95%) ~ CPCSU08RF (65%)								01	○
	CPCSU08RS	set of 5pcs. CPCSU08RA (100%) ~ CPCSU08RE (70%)								01	○

UNC-UNF	Code	LF (mm)	L (mm)	D1 (Thread engagement ratio)	D2 (Thread engagement ratio)	DCON (mm)	L1 (mm)	L2 (mm)	L3 (mm)	Type	Stock	
YMW												
1/2-20UNF	CPCSU08NA	121	33	11.329 (100%)	11.463 (90%)	12	19.1	25.4	31.8	01	○	
	CPCSU08NB	121	33	11.394 (95%)	11.531 (85%)	12	19.1	25.4	31.8	01	○	
	CPCSU08NC	121	33	11.463 (90%)	11.600 (80%)	12	19.1	25.4	31.8	01	○	
	CPCSU08ND	121	33	11.531 (85%)	11.669 (75%)	12	19.1	25.4	31.8	01	○	
	CPCSU08NE	121	33	11.600 (80%)	11.738 (70%)	12	19.1	25.4	31.8	01	○	
	CPCSU08NF	121	33	11.669 (75%)	11.806 (65%)	12	19.1	25.4	31.8	01	○	
	CPCSU08NM	set of 5pcs. CPCSU08NB (95%) ~ CPCSU08NF (65%)									01	○
	CPCSU08NS	set of 5pcs. CPCSU08NA (100%) ~ CPCSU08NE (70%)									01	○

Intro

SP

SL

PO

ST

ROLL

CARBIDE

LONG

HAND
TAPS

EG (STI)

SPECIAL
THREADS,
GAUGES
YMWTHREAD
MILLS

DIES

CENTER
DRILLSTechnical
info

Intro

CPR-S

Inspection Tools

SP

Check Pins (Straight Type) for Bored Hole for Forming Taps

SL

HSS

PO

ST

ROLL

CARBIDE

LONG

HAND
TAPS

EG (STI)

SPECIAL
THREADS,
GAUGES
YMW

THREAD
MILLS

DIES

CENTER
DRILLS

Technical
info



FEATURES

HSS material increases considerably the Check Pins life.

CPR-S allows accurate checking of bored hole diameter and length.

For forming tap.

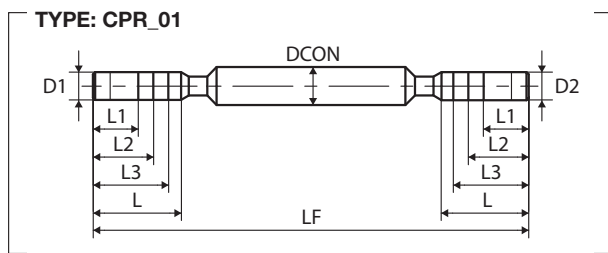

M-MF	Code	LF (mm)	L (mm)	D1	D2	DCON (mm)	L1 (mm)	L2 (mm)	L3 (mm)	Type	Stock
YMW											
M2X0.4	CPRS2.0E	41.5	5.5	1.79	1.84	3	3	4	5	01	○
M2X0.25	CPRS2.0B	41.5	5.5	1.89	1.92	3	3	4	5	01	○
M2.5X0.45	CPRS2.5F	45	7.5	2.27	2.34	3	3.75	5	6.25	01	○
M2.5X0.35	CPRS2.5D	45	7.5	2.34	2.38	3	3.75	5	6.25	01	○
M2.6X0.45	CPRS2.6F	45	7.5	2.37	2.44	3	3.9	5.2	6.5	01	○
M3X0.5	CPRS3.0G	49	9	2.75	2.82	4	4.5	6	7.5	01	○
M3X0.35	CPRS3.0D	49	9	2.84	2.88	4	4.5	6	7.5	01	○
M3.5X0.6	CPRS3.5H	57	11	3.19	3.27	5	5.25	7	8.75	01	○
M3.5X0.35	CPRS3.5D	57	11	3.34	3.38	5	5.25	7	8.75	01	○
M4X0.7	CPRS4.0I	57	11	3.65	3.72	5	6	8	10	01	○
M4X0.5	CPRS4.0G	57	11	3.76	3.83	5	6	8	10	01	○
M5X0.8	CPRS5.0K	65	14	4.59	4.67	5.5	7.5	10	12.5	01	○
M5X0.5	CPRS5.0G	65	14	4.76	4.83	5.5	7.5	10	12.5	01	○
M6X1	CPRS6.0M	73	16.5	5.49	5.59	6	9	12	15	01	○
M6X0.75	CPRS6.0J	73	16.5	5.61	5.69	6	9	12	15	01	○
M7X1	CPRS7.0M	99	22	6.49	6.59	8	10.5	14	17.5	01	○
M7X0.75	CPRS7.0J	99	22	6.62	6.70	8	10.5	14	17.5	01	○
M8X1.25	CPRS8.0N	99	22	7.36	7.49	8	12	16	20	01	○
M8X1	CPRS8.0M	99	22	7.49	7.59	8	12	16	20	01	○
M8X0.75	CPRS8.0J	99	22	7.62	7.70	8	12	16	20	01	○
M10X1.5	CPRS0100	110	27.5	9.22	9.34	10	15	20	25	01	○
M10X1.25	CPRS010N	110	27.5	9.35	9.49	10	15	20	25	01	○
M10X1	CPRS010M	110	27.5	9.49	9.59	10	15	20	25	01	○
M12X1.75	CPRS012P	121	33	11.09	11.23	12	18	24	30	01	○
M12X1.5	CPRS012O	121	33	11.22	11.34	12	18	24	30	01	○
M12X1.25	CPRS012N	121	33	11.36	11.50	12	18	24	30	01	○
M12X1	CPRS012M	121	33	11.49	11.59	12	18	24	30	01	○
UNC-UNF	Code	LF (mm)	L (mm)	D1	D2	DCON (mm)	L1 (mm)	L2 (mm)	L3 (mm)	Type	Stock
YMW											
No.2-56UNC	CPRSUN2E	41.5	5.5	1.96	2.04	3	3.3	4.4	5.5	01	○
No.2-64UNF	CPRSUN2D	41.5	5.5	1.98	2.06	3	3.3	4.4	5.5	01	○
No.3-48UNC	CPRSUN3F	45	7.5	2.25	2.35	3	3.8	5	6.3	01	○
No.3-56UNF	CPRSUN3E	45	7.5	2.29	2.37	3	3.8	5	6.3	01	○
No.4-40UNC	CPRSUN4H	49	9	2.54	2.64	4	4.3	5.7	7.1	01	○
No.4-48UNF	CPRSUN4F	49	9	2.59	2.68	4	4.3	5.7	7.1	01	○
No.5-40UNC	CPRSUN5H	49	9	2.87	2.97	4	4.8	6.4	7.9	01	○
No.5-44UNF	CPRSUN5G	49	9	2.90	2.99	4	4.8	6.4	7.9	01	○
No.6-32UNC	CPRSUN6J	57	11	3.11	3.22	5	5.3	7	8.8	01	○
No.6-40UNF	CPRSUN6H	57	11	3.19	3.29	5	5.3	7	8.8	01	○
No.8-32UNC	CPRSUN8J	57	11	3.78	3.89	5	6.3	8.3	10.4	01	○
No.8-36UNF	CPRSUN8I	57	11	3.81	3.91	5	6.3	8.3	10.4	01	○
No.10-24UNC	CPRSUNAM	65	14	4.30	4.44	5.5	7.2	9.7	12.1	01	○
No.10-32UNF	CPRSUNAJ	65	14	4.44	4.53	5.5	7.2	9.7	12.1	01	○
No.12-24UNC	CPRSUNCM	73	16.5	4.96	5.07	6	8.2	11	13.7	01	○
No.12-28UNF	CPRSUNCK	73	16.5	5.03	5.13	6	8.2	11	13.7	01	○
1/4-20UNC	CPRSUN4N	73	16.5	5.73	5.86	6	9.5	12.7	15.9	01	○

Intro

SP

SL

PO

ST

ROLL

CARBIDE

LONG

HAND TAPS

EG (STI)

SPECIAL THREADS, GAUGES YMW

THREAD MILLS

DIES

CENTER DRILLS

Technical info

Special Threads, Gauges

Intro

	UNC-UNF	Code	LF (mm)	L (mm)	D1	D2	DCON (mm)	L1 (mm)	L2 (mm)	L3 (mm)	Type	Stock
	YMW											
	1/4-28UNF	CPRSU04K	73	16.5	5.91	6.00	6	9.5	12.7	15.9	01	○
SP	5/16-18UNC	CPRSU050	99	22	7.23	7.38	8	12	16	20	01	○
	5/16-24UNF	CPRSU05M	99	22	7.42	7.53	8	12	16	20	01	○
	3/8-16UNC	CPRSU06P	110	27.5	8.72	8.89	10	14.3	19.1	23.8	01	○
SL	3/8-24UNF	CPRSU06M	110	27.5	8.99	9.10	10	14.3	19.1	23.8	01	○
	7/16-14UNC	CPRSU07Q	121	33	10.20	10.40	12	16.7	22.2	27.8	01	○
	7/16-20UNF	CPRSU07N	121	33	10.48	10.62	12	16.7	22.2	27.8	01	○
	1/2-13UNC	CPRSU08R	121	33	11.70	11.92	12	19.1	25.4	31.8	01	○
PO	1/2-20UNF	CPRSU08N	121	33	12.06	12.20	12	19.1	25.4	31.8	01	○

ST

ROLL

CARBIDE

LONG

HAND
TAPS

EG (STI)

SPECIAL
THREADS,
GAUGES
YMW

THREAD
MILLS

DIES

CENTER
DRILLS

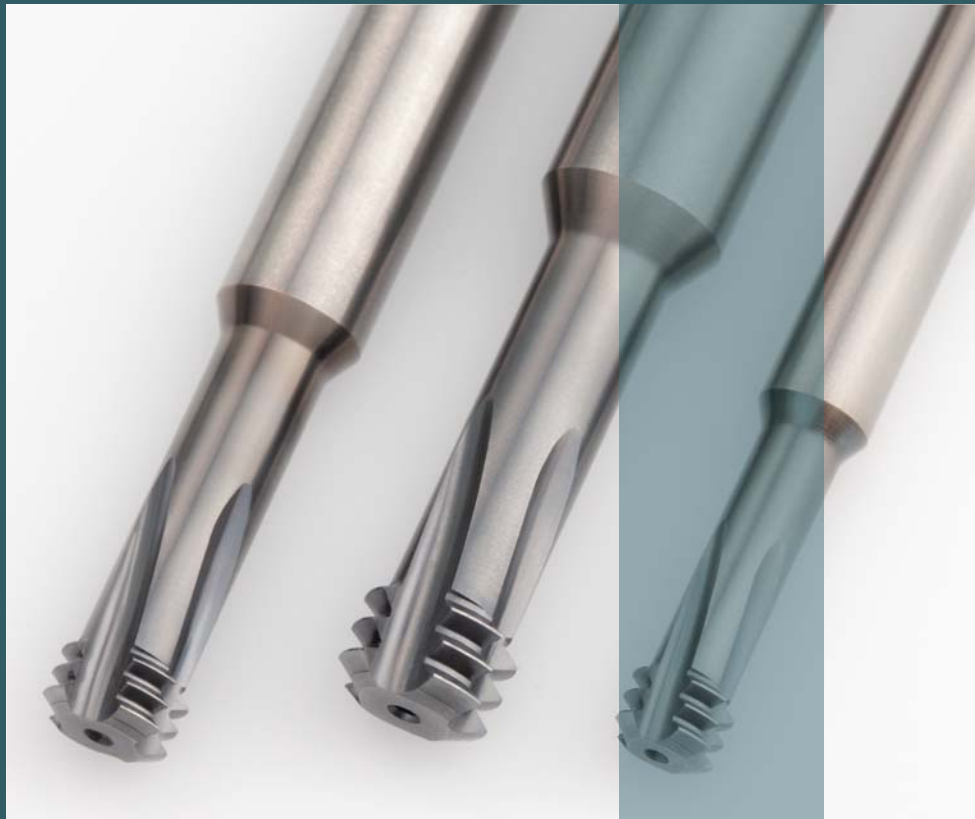

Technical
info

THREAD MILLS



THREAD MILLS - YMW **586**

Selection Chart

	Thread Mills			
	PRML	PRML TI		
	HF CARBIDE COATING	HF CARBIDE COATING		
Intro				
SP				
SL				
PO				
ST				
ROLL				
	YMW	YMW		
CARBIDE	M	587	589	
	MF	587	589	
	UNC/UNF	587	589	
	UNS, 8, 12, 20, 32UN			
	UNEF			
	G (BSP)			
	Rp (BSPP)			
	Rc (BSPT)			
	LONG	NPT		
		NPTF		
NPSC, NPSM, NPSF				
BSW				
HAND TAPS	EG(STI), M, MF, UNC/UNF			
	Pg			
	Tr			
	S miniature			
	Special threads			
	Vc (m/min)			
EG (STI)	P1	★		
	P2	★		
	P3	★		
	P4	★		
	P5	★		
	P6	★		
	P7		★	
	P8			
THREAD MILLS	M1		★	
	M2		★	
	M3		★	
	K1	★		
DIES	K2	★		
	K3			
	K4			
	N1			
CENTER DRILLS	N2			
	N3			
	N4			
	N5			
	S1 (<25 HRC)			
	S2 (<35 HRC)			
Technical info	S3 (35 ÷ 45 HRC)			
	S5		★	
	H (45 ÷ 55 HRC)			
	H (55 ÷ 63 HRC)			

★ 1st choice ☆ suitable

Intro

SP

SL

PO

ST

ROLL

CARBIDE

LONG

HAND
TAPS

EG (STI)

SPECIAL
THREADS,
GAUGES

**THREAD
MILLS**

DIES

CENTER
DRILLS

Technical
info

Intro

PRML



SP

Premium Thread Mills

SL



FEATURES

Ultra-fine micrograin carbide

Specific design and special coating for extraordinary thread surface finishing.

Low cutting resistance and reduced side forces, allow to produce internal threads with high accuracy and straightness.

PO

RECOMMENDED APPLICATIONS

ISO		ISO	
P1	★	K1	★
P2	★	K2	★
P3	★		
P4	★		
P5	★		
P6	★		

★ 1st choice ☆ suitable



WATCH THE VIDEO

ST

ROLL

CARBIDE

Product Features

Work-materials	Vc (m/min)	Feed per tooth fz(mm/t)
Thermal Refined Steel 35 to 45HRC	40÷100	0.02÷0.05
Thermal Refined Steel 25 to 35HRC	40÷100	0.03÷0.06
Grey Cast Iron	40÷100	0.02÷0.05
Nodular Cast Iron	40÷100	0.02÷0.05
Alloy Steel	40÷100	0.04÷0.06
High Carbon Steel	40÷100	0.04÷0.06
Medium Carbon Steel	60÷100	0.03÷0.05
Low Carbon Steel	60÷100	0.03÷0.05

The PRML is a left hand cutting tool.

The tool rotates counter clockwise.

The PRML feeds in the Z axis from the top as shown below.

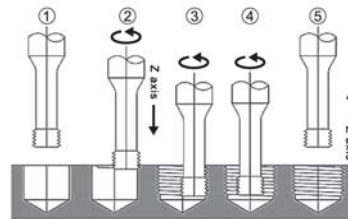

LONG

HAND TAPS

Process Data

PRML 9.0P1.75 M12x1.75

Work-material	42CrMo4 - 1.7225 (30HRC)
Cutting Speed	100 m/min
Feed per tooth fz	0.06 mm/t
Cutting Depth	24 mm
Hole diameter	ø10.3
Number of insection	1
Machine	Machining Center (BT30)
Lubricant	Water soluble oil (x20)

Degradation of Pitch Diameter

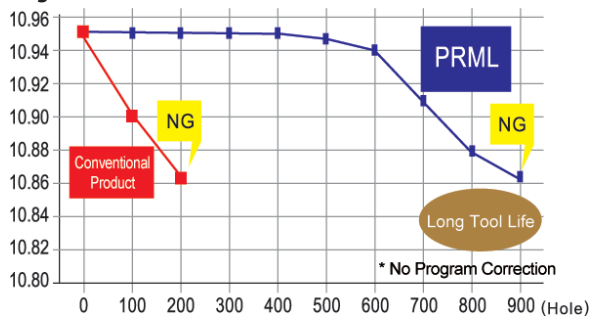

EG (STI)

SPECIAL THREADS, GAUGES

THREAD MILLS
YMW

DIES

Internal coolant

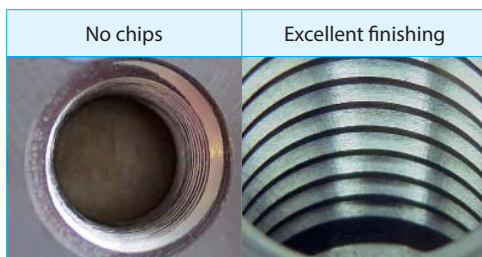

External coolant

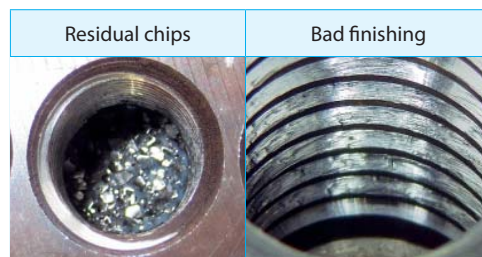

CENTER DRILLS

Technical info

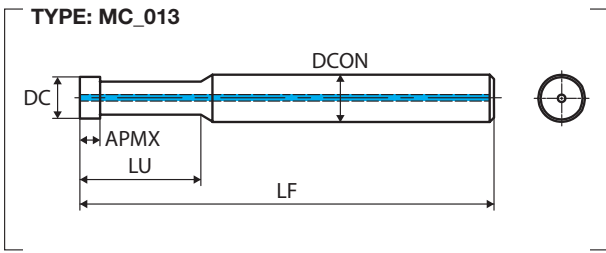

DC x TP	Minimum thread size	Maximum threading depth (mm)	Code	DC (mm)	TP (mm)	LF (mm)	APMX (mm)	LU (mm)	DCON (mm)	ZEFP	Type	Stock
YMW		M-MF										
3.5X0.8	M5X0.8	10	MH3.5KNEXLM	3.5	0.8	60	2.4	12	6	3	013	○
4X1	M6X1	12	MH4.0MNEXLM	4	1	60	3	14	6	3	013	○
4X0.75	M6X0.75	12	MH4.0JNEXLM	4	0.75	60	2.3	14	6	3	013	○
6X1.25	M8X1.25	16	MH6.0NNEXLM	6	1.25	70	3.8	18	6	4	013	○
6X1	M8X1	16	MH6.0MNEXLM	6	1	70	3	18	6	4	013	○
7.5X1.5	M10X1.5	20	MH7.5ONEXLM	7.5	1.5	80	4.5	22	8	4	013	○
7.5X1.25	M10X1.25	20	MH7.5NNEXLM	7.5	1.25	80	3.8	22	8	4	013	○
7.5X1	M10X1	20	MH7.5MNEXLM	7.5	1	80	3	22	8	4	013	○
9X1.75	M12X1.75	24	MH9.0PNEXLM	9	1.75	90	5.3	26	10	4	013	○
9X1.5	M12X1.5	24	MH9.0ONEXLM	9	1.5	90	4.5	26	10	4	013	○
9X1.25	M12X1.25	24	MH9.0NNEXLM	9	1.25	90	3.8	26	10	4	013	○

DC x TPI	Minimum thread size	Maximum threading depth (mm)	Code	DC (mm)	TPI (threads per inch)	LF (mm)	APMX (mm)	LU (mm)	DCON (mm)	ZEFP	Type	Stock
YMW		UNC-UNF										
3.5X24	No.10-24	9.7	MH3.5MNEXLU	3.5	24	60	3.2	11.7	6	3	013	○
3.5X32	No.10-32	9.7	MH3.5JNEXLU	3.5	32	60	2.4	11.7	6	3	013	○
4.5X20	1/4-20	12.7	MH4.5NNEXLU	4.5	20	60	3.8	14.7	6	4	013	○
4.5X28	1/4-28	12.7	MH4.5KNEXLU	4.5	28	60	2.7	14.7	6	4	013	○
5.8X18	5/16-18	15.9	MH5.8ONEXLU	5.8	18	70	4.2	17.9	6	4	013	○
5.8X24	5/16-24	19.1	MH5.8MNEXLU	5.8	24	70	3.2	21.1	6	4	013	○
6X16	3/8-16	19.1	MH6.0PNEXLU	6	16	70	4.8	21.1	6	4	013	○
8X14	7/16-14	22.2	MH8.0QNEXLU	8	14	80	5.4	24.2	8	4	013	○
8X20	7/16-20	25.4	MH8.0NNEXLU	8	20	90	3.8	27.4	8	4	013	○
9X13	1/2-13	25.4	MH9.0RNEXLU	9	13	90	5.9	27.4	10	4	013	○

Intro

SP

SL

PO

ST

ROLL

CARBIDE

LONG

HAND TAPS

EG (STI)

SPECIAL THREADS, GAUGES

THREAD MILLS

YMW

DIES

CENTER DRILLS

Technical info

Intro

PRML TI



SP

Premium Thread Mills

SL



PO

RECOMMENDED APPLICATIONS

ISO	ISO	ISO
P7 ★	M1 ★	S5 ★
	M2 ★	
	M3 ★	

★ 1st choice ☆ suitable

ST

ROLL

CARBIDE

Product Features

Work-materials	Vc (m/min)	Feed per flute fz (mm/t)
Titanium alloys	40÷60	0.02÷0.06
Austenitic stainless steel	60÷80	0.06÷0.08
Martensitic stainless steel	40÷60	0.02÷0.06

LONG

HAND TAPS

Speed:
 $RPM = 1000 \times Vc / 3.14 / \text{PRML TI diameter (Dc)}$
 $F \text{ (mm/min)} = fz \times \text{Number of flutes} \times RPM \times (\text{internal nominal diameter} - \text{PRML TI diameter (Dc)}) / \text{Thread nominal diameter}.$

EG (STI)

Process Data

Process conditions: 6.0 P1.0 (Code: MH6.0MNIWLM)

Work-material	TiAl6V4
Cutting Speed	50 m/min
Feed per flute fz	0.04 mm/t
Threading length	10 mm
Hole diameter	ø7.0
Number of passes	1
Machine	Machining Center (BT30)
Lubricant	Water soluble oil (x20)

SPECIAL THREADS, GAUGES

THREAD MILLS
YMW

DIES

CENTER DRILLS

Technical info

FEATURES

Ultra-fine micrograin carbide

Specific design and special coating for Titanium base alloys and stainless steel .

Low cutting resistance and reduced side forces, allow to produce internal threads with high accuracy and straightness.

The PRML TI is a left hand cutter, please use a counterclockwise spindle rotation. Process the thread from top to bottom like 2 to 3. For programming, please visit our website.

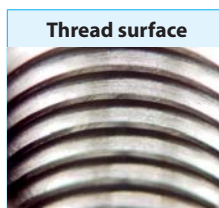
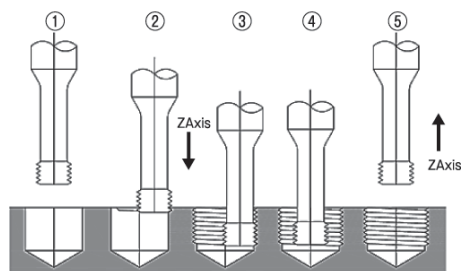

Excellent thread surface even after several holes threaded

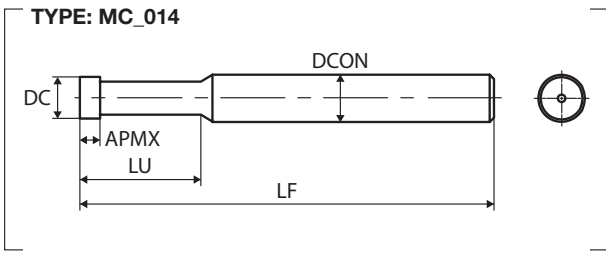

DC x TP	Minimum thread size	Maximum threading depth (mm)	Code	DC (mm)	TP (mm)	LF (mm)	APMX (mm)	LU (mm)	DCON (mm)	ZEFP	Type	Stock
YMW		M-MF										
6X1.25	M8X1.25	16	MH6.ONNIWLM	6	1.25	70	3.8	18	6	4	014	○
6X1	M8X1	16	MH6.0MNIWLM	6	1	70	3	18	6	4	014	○
7.5X1.5	M10X1.5	20	MH7.5ONIWLM	7.5	1.5	80	4.5	22	8	4	014	○
7.5X1.25	M10X1.25	20	MH7.5NNIWLM	7.5	1.25	80	3.8	22	8	4	014	○
7.5X1	M10X1	20	MH7.5MNIWLM	7.5	1	80	3	22	8	4	014	○
9X1.75	M12X1.75	24	MH9.0PNIWLM	9	1.75	90	5.3	26	10	4	014	○
9X1.5	M12X1.5	24	MH9.0ONIWLM	9	1.5	90	4.5	26	10	4	014	○
9X1.25	M12X1.25	24	MH9.ONNIWLM	9	1.25	90	3.8	26	10	4	014	○

DC x TPI	Minimum thread size	Maximum threading depth (mm)	Code	DC (mm)	TPI (threads per inch)	LF (mm)	APMX (mm)	LU (mm)	DCON (mm)	ZEFP	Type	Stock
YMW		UNC-UNF										
5.8X18	5/16-18	15.9	MH5.8ONIWLU	5.8	18	70	4.2	17.9	6	4	014	○
5.8X24	5/16-24	19.1	MH5.8MNIWLU	5.8	24	70	3.2	21.1	6	4	014	○
6X16	3/8-16	19.1	MH6.0PNIWLU	6	16	70	4.8	21.1	6	4	014	○
8X14	7/16-14	22.2	MH8.0QNIWLU	8	14	80	5.4	24.2	8	4	014	○
8X20	7/16-20	25.4	MH8.ONNIWLU	8	20	90	3.8	27.4	8	4	014	○
9X13	1/2-13	25.4	MH9.0RNIWLU	9	13	90	5.9	27.4	10	4	014	○

Intro

SP

SL

PO

ST

ROLL

CARBIDE

LONG

HAND TAPS

EG (STI)

SPECIAL THREADS, GAUGES

THREAD MILLS

YMW

DIES

CENTER DRILLS

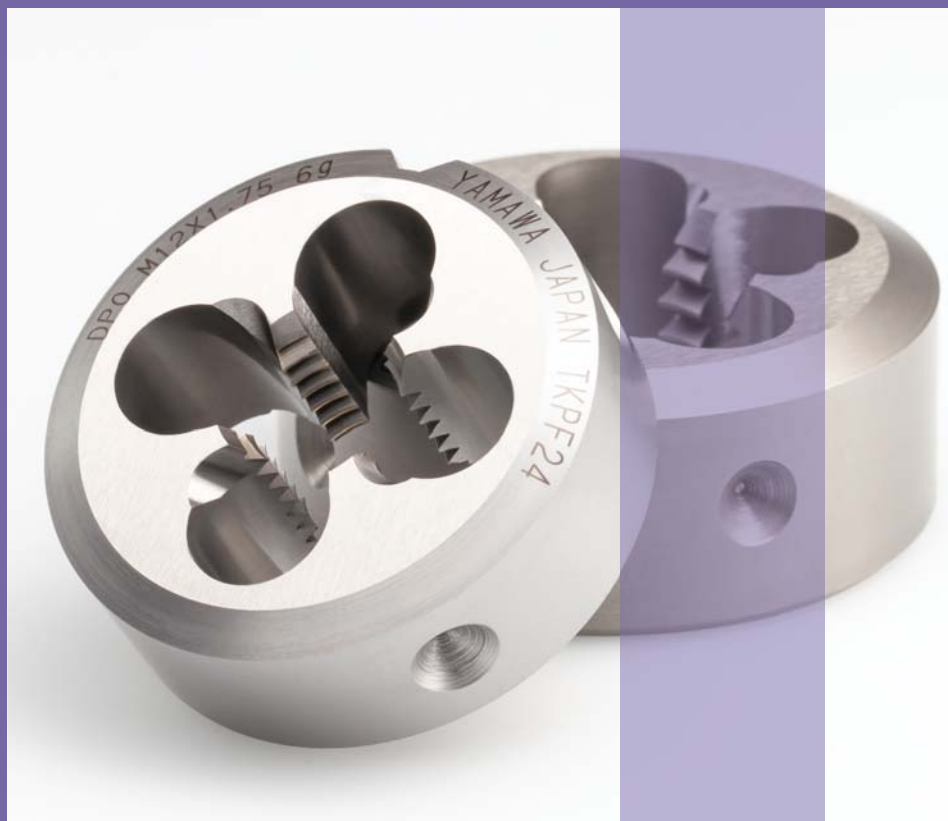

Technical info

DIES



DIES - DIN **594**
DIES - JIS **598**

Selection Chart

	Dies	
	DPO	HS-D
Intro		
SP	HSS	HSS OX
SL		
PO		
ST		
ROLL		
	DIN	JIS
	M	594 599
	MF	595 600
	UNC/UNF	596
CARBIDE	UNS, 8, 12, 20, 32UN	
	UNEF	
	G (BSP)	597
	Rp (BSPP)	
	Rc (BSPT)	
LONG	NPT	597
	NPTF	
	NPSC, NPSM, NPSF	
	BSW	
	EG(STI), M, MF, UNC/UNF	
HAND TAPS	Pg	
	Tr	
	S miniature	
	Special threads	
	Vc (m/min)	
EG (STI)	P1 ★ 2÷5	★ 3÷5
	P2 ★ ≤3	★ ≤3
	P3	
	P4	
SPECIAL THREADS, GAUGES	P5	
	P6	
	P7	★ ≤2
	P8	
THREAD MILLS	M1	★ ≤2
	M2	★ ≤2
	M3	
	K1	
	K2	
	K3	
	K4	
DIES	N1	
	N2	
	N3	
	N4 ★ ≤5	
	N5	
CENTER DRILLS	S1 (<25 HRC)	
	S2 (<35 HRC)	
	S3 (35 ÷ 45 HRC)	
	S5	
	H (45 ÷ 55 HRC)	
Technical info	H (55 ÷ 63 HRC)	

★ 1st choice ☆ suitable

Intro

SP

SL

PO

ST

ROLL

CARBIDE

LONG

HAND
TAPS

EG (STI)

SPECIAL
THREADS,
GAUGES

THREAD
MILLS

DIES

CENTER
DRILLS

Technical
info

Intro

DPO

SP

HSS Spiral Pointed Dies



SL



FEATURES

Spiral pointed (PO) design allows very smooth chip ejection.

PO

RECOMMENDED TAPPING SPEEDS DEPENDING ON MATERIALS

ISO	Vc (m/min)	★	ISO	Vc (m/min)	★
P1	2÷5	★	N4	≤5	★
P2	≤3	★			

ST

★ 1st choice ☆ suitable

ROLL

CARBIDE

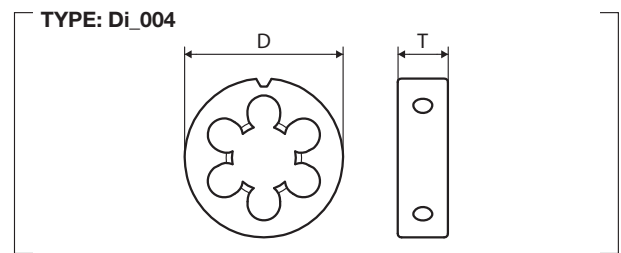
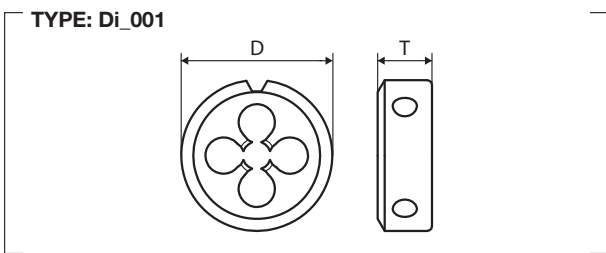

LONG

HAND TAPS

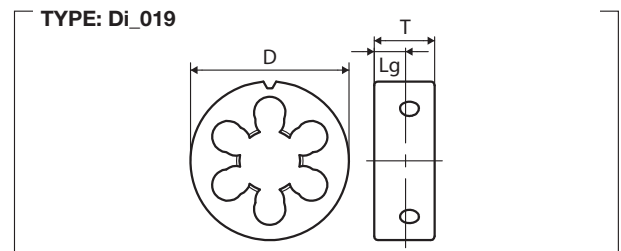
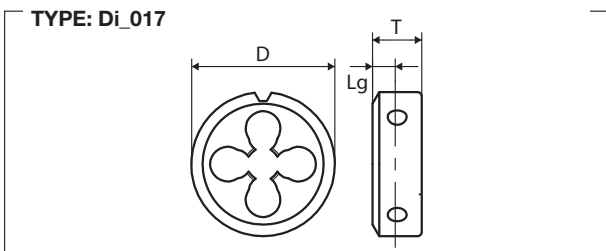

EG (STI)

SPECIAL THREADS, GAUGES

THREAD MILLS

DIES

DIN

CENTER DRILLS

Technical info

M	TCTR (tolerance)	Bar Ø (mm)	Code	THCHT (chamfer)	D (mm)	T (mm)	Clearance holes	Type	Stock
DIN 223									
M1X0.25	6g	0.95	PDD1.0BLNEBC	1.5P	16	5	3	001	○
M1.1X0.25	6g	1.05	PDD1.1BLNEBC	1.5P	16	5	3	001	○
M1.2X0.25	6g	1.15	PDD1.2BLNEBC	1.5P	16	5	3	001	○
M1.4X0.3	6g	1.34	PDD1.4CLNEBC	1.5P	16	5	3	001	○
M1.6X0.35	6g	1.52	PDD1.6DLNEBC	1.5P	16	5	3	001	●
M1.7X0.35	6g	1.62	PDD1.7DLNEBC	1.5P	16	5	3	001	○
M1.8X0.35	6g	1.72	PDD1.8DLNEBC	1.5P	16	5	3	001	○
M2X0.4	6g	1.91	PDD2.0ELNEBC	1.5P	16	5	3	001	●
M2.2X0.45	6g	2.11	PDD2.2FLNEBC	1.5P	16	5	3	001	○
M2.3X0.4	6g	2.21	PDD2.3ELNEBC	1.5P	16	5	3	001	○

M	TCTR (tolerance)	Bar Ø (mm)	Code	THCHT (chamfer)	D (mm)	T (mm)	Clearance holes	Type	Stock
DIN 223									
M2.5X0.45	6g	2.41	PDD2.5FLNEBC	1.5P	16	5	3	001	●
M2.6X0.45	6g	2.51	PDD2.6FLNEBC	1.5P	16	5	3	001	○
M3X0.5	6g	2.90	PDE3.0GLNEBC	1.5P	20	5	3	001	●
M3.5X0.6	6g	3.39	PDE3.5HLNEBC	1.5P	20	5	3	001	○
M4X0.7	6g	3.87	PDE4.0ILNEBC	1.5P	20	5	3	001	●
M5X0.8	6g	4.86	PDE5.0KLNEBC	1.5P	20	7	4	001	●
M6X1	6g	5.84	PDE6.0MLNEBC	1.5P	20	7	4	001	●
M7X1	6g	6.84	PDG7.0MLNEBC	1.5P	25	9	4	001	●
M8X1.25	6g	7.81	PDG8.0NLNEBC	1.5P	25	9	4	001	●
M9X1.25	6g	8.81	PDG9.0NLNEBC	1.5P	25	9	5	001	○
M10X1.5	6g	9.79	PDH0100LNEBC	1.5P	30	11	4	001	●
M11X1.5	6g	10.79	PDH0110LNEBC	1.5P	30	11	5	001	○
M12X1.75	6g	11.80	PDJ012PLNEBC	1.5P	38	14	4	001	●
M14X2	6g	13.80	PDJ014QLNEBC	1.5P	38	14	5	001	●
M16X2	6g	15.80	PDL016QLNEBC	1.5P	45	18	5	001	●
M18X2.5	6g	17.70	PDL018RLNEBC	1.5P	45	18	5	001	●
M20X2.5	6g	19.70	PDL020RLNEBC	1.5P	45	18	5	001	●
M22X2.5	6g	21.70	PDP022RLNEBC	1.5P	55	16	5	001	●
M24X3	6g	23.70	PDP024SLNEBC	1.5P	55	16	5	001	●
M27X3	6g	26.70	PDS027SLNEBC	1.5P	65	25	6	004	●
M30X3.5	6g	29.60	PDS030TLNEBC	1.5P	65	18	6	004	●
M33X3.5	6g	32.60	PDS033TLNEBC	1.5P	65	25	8	004	○
M36X4	6g	35.60	PDS036ULNEBC	1.5P	65	25	8	004	○
MF	TCTR (tolerance)	Bar Ø (mm)	Code	THCHT (chamfer)	D (mm)	T (mm)	Clearance holes	Type	Stock
DIN 223									
M2X0.25	6g	1.93	PDD2.0BLNEBC	1.5P	16	5	3	001	○
M2.5X0.35	6g	2.42	PDD2.5DLNEBC	1.5P	16	5	3	001	○
M3X0.35	6g	2.92	PDE3.0DLNEBC	1.5P	20	5	3	001	○
M4X0.5	6g	3.90	PDE4.0GLNEBC	1.5P	20	5	3	001	○
M5X0.5	6g	4.90	PDE5.0GLNEBC	1.5P	20	5	4	001	○
M6X0.75	6g	5.87	PDE6.0JLNEBC	1.5P	20	7	4	001	○
M6X0.5	6g	5.89	PDE6.0GLNEBC	1.5P	20	5	4	001	○
M7X0.75	6g	6.87	PDG7.0JLNEBC	1.5P	25	9	4	001	○
M8X1	6g	7.84	PDG8.0MLNEBC	1.5P	25	9	4	001	●
M8X0.75	6g	7.87	PDG8.0JLNEBC	1.5P	25	9	4	001	○
M8X0.5	6g	7.89	PDG8.0GLNEBC	1.5P	25	9	4	001	○
M9X1	6g	8.84	PDG9.0MLNEBC	1.5P	25	9	5	001	○
M10X1.25	6g	9.81	PDH010NLNEBC	1.5P	30	11	4	001	●
M10X1	6g	9.84	PDH010MLNEBC	1.5P	30	11	4	001	●
M10X0.75	6g	9.87	PDH010JLNEBC	1.5P	30	11	4	001	○
M10X0.5	6g	9.89	PDH010GLNEBC	1.5P	30	11	4	001	○
M12X1.5	6g	11.80	PDJ0120LNEBC	1.5P	38	10	4	001	●
M12X1.25	6g	11.80	PDJ012NLNEBC	1.5P	38	10	4	001	●
M12X1	6g	11.84	PDJ012MLNEBC	1.5P	38	10	4	001	●
M12X0.75	6g	11.86	PDJ012JLNEBC	1.5P	38	10	4	001	○
M12X0.5	6g	11.88	PDJ012GLNEBC	1.5P	38	10	4	001	○

Intro

SP

SL

PO

ST

ROLL

CARBIDE

LONG

HAND
TAPS

EG (STI)

SPECIAL
THREADS,
GAUGESTHREAD
MILLS

DIES

DIN

CENTER
DRILLSTechnical
info

Intro

	MF	TCTR (tolerance)	Bar Ø (mm)	Code	THCHT (chamfer)	D (mm)	T (mm)	Clearance holes	Type	Stock
DIN 223										
SP	M14X1.5	6g	13.80	PDJ0140LNEBC	1.5P	38	10	5	001	●
	M14X1.25	6g	13.82	PDJ014NLNEBC	1.5P	38	10	5	001	○
	M14X1	6g	13.84	PDJ014MLNEBC	1.5P	38	10	5	001	○
SL	M15X1.5	6g	14.80	PDJ0150LNEBC	1.5P	38	10	5	001	○
	M16X1.5	6g	15.80	PDL0160LNEBC	1.5P	45	14	5	001	●
	M16X1	6g	15.84	PDL016MLNEBC	1.5P	45	14	5	001	○
PO	M18X2	6g	17.80	PDL018QLNEBC	1.5P	45	14	5	001	○
	M18X1.5	6g	17.80	PDL0180LNEBC	1.5P	45	14	5	001	●
	M18X1	6g	17.84	PDL018MLNEBC	1.5P	45	14	5	001	○
ST	M20X2	6g	19.80	PDL020QLNEBC	1.5P	45	14	5	001	○
	M20X1.5	6g	19.80	PDL0200LNEBC	1.5P	45	14	5	001	●
	M20X1	6g	19.84	PDL020MLNEBC	1.5P	45	14	5	001	○
ROLL	M22X2	6g	21.80	PDP022QLNEBC	1.5P	55	16	5	001	○
	M22X1.5	6g	21.80	PDP0220LNEBC	1.5P	55	16	5	001	●
	M22X1	6g	21.84	PDP022MLNEBC	1.5P	55	16	5	001	○
CARBIDE	M24X2	6g	23.80	PDP024QLNEBC	1.5P	55	16	5	001	●
	M24X1.5	6g	23.80	PDP0240LNEBC	1.5P	55	16	5	001	●
	M24X1	6g	23.84	PDP024MLNEBC	1.5P	55	16	5	001	○
LONG	M26X1.5	6g	25.80	PDP0260LNEBC	1.5P	55	16	6	001	○
	M27X2	6g	26.80	PDS027QLNEBC	1.5P	65	18	6	004	○
	M27X1.5	6g	26.80	PDS0270LNEBC	1.5P	65	18	6	004	○
HAND TAPS	M27X1	6g	26.84	PDS027MLNEBC	1.5P	65	18	6	004	○
	M28X2	6g	27.80	PDS028QLNEBC	1.5P	65	18	6	004	○
	M28X1.5	6g	27.80	PDS0280LNEBC	1.5P	65	18	6	004	○
EG (STI)	M30X1.5	6g	29.80	PDS0300LNEBC	1.5P	65	18	6	004	○

HAND TAPS

	UNC	TCTR (tolerance)	Bar Ø (mm)	Code	THCHT (chamfer)	D (mm)	T (mm)	Clearance holes	Type	Stock
DIN 2568										
SPECIAL THREADS, GAUGES	No.1-64UNC	2A	1.77	PDDUN1DGNEBC	1.5P	16	5	3	001	○
	No.2-56UNC	2A	2.09	PDDUN2EGNEBC	1.5P	16	5	3	001	○
	No.3-48UNC	2A	2.41	PDDUN3FGNEBC	1.5P	16	5	3	001	○
THREAD MILLS	No.4-40UNC	2A	2.73	PDEUN4HGNEBC	1.5P	20	5	3	001	○
	No.5-40UNC	2A	3.06	PDEUN5HGNEBC	1.5P	20	5	3	001	○
	No.6-32UNC	2A	3.37	PDEUN6JGNEBC	1.5P	20	7	3	001	○
DIES	No.8-32UNC	2A	4.03	PDEUN8JGNEBC	1.5P	20	7	3	001	○
	No.10-24UNC	2A	4.66	PDEUNAMGNEBC	1.5P	20	7	4	001	○
	No.12-24UNC	2A	5.32	PDEUNCMGNEBC	1.5P	20	7	4	001	○
DIN	1/4-20UNC	2A	6.17	PDGU04NGNEBC	1.5P	25	9	4	001	○
	5/16-18UNC	2A	7.74	PDGU050GNEBC	1.5P	25	9	4	001	○
	3/8-16UNC	2A	9.31	PDHU06PGNEBC	1.5P	30	11	4	001	○
CENTER DRILLS	7/16-14UNC	2A	10.88	PDHU07QGNEBC	1.5P	30	11	5	001	○
	1/2-13UNC	2A	12.40	PDJU08RGNEBC	1.5P	38	14	4	001	○
	9/16-12UNC	2A	14.00	PDJU09SGNEBC	1.5P	38	14	5	001	○
TECHNICAL INFO	5/8-11UNC	2A	15.60	PDLU10UGNEBC	1.5P	45	18	5	001	○
	3/4-10UNC	2A	18.80	PDLU12VGNEBC	1.5P	45	18	5	001	○
	7/8-9UNC	2A	21.90	PDPU14WGNEBC	1.5P	55	22	5	001	○
	1 -8UNC	2A	25.10	PDPU16XGNEBC	1.5P	55	22	5	001	○

Technical info

UNF	TCTR (tolerance)	Bar Ø (mm)	Code	THCHT (chamfer)	D (mm)	T (mm)	Clearance holes	Type	Stock
DIN 2568									
No.0-8UNF	2A	1.45	PDDUN0BGNEBC	1.5P	16	5	3	001	○
No.1-72UNF	2A	1.77	PDDUN1CGNEBC	1.5P	16	5	3	001	○
No.2-64UNF	2A	2.10	PDDUN2DGNEBC	1.5P	16	5	3	001	○
No.3-56UNF	2A	2.42	PDDUN3EGNEBC	1.5P	16	5	3	001	○
No.4-48UNF	2A	2.74	PDEUN4FGNEBC	1.5P	20	5	3	001	○
No.5-44UNF	2A	3.07	PDEUN5GGNEBC	1.5P	20	5	3	001	○
No.6-40UNF	2A	3.39	PDEUN6HGNEBC	1.5P	20	5	3	001	○
No.8-36UNF	2A	4.04	PDEUN8IGNEBC	1.5P	20	7	3	001	○
No.10-32UNF	2A	4.69	PDEUNAJGNEBC	1.5P	20	7	4	001	○
No.12-28UNF	2A	5.34	PDEUNCKGNEBC	1.5P	20	7	4	001	○
1/4-28UNF	2A	6.20	PDGU04KGNEBC	1.5P	25	9	4	001	○
5/16-24UNF	2A	7.77	PDGU05MGNEBC	1.5P	25	9	4	001	○
3/8-24UNF	2A	9.36	PDHU06MGNEBC	1.5P	30	11	4	001	○
7/16-20UNF	2A	10.93	PDHU07NGNEBC	1.5P	30	11	5	001	○
1/2-20UNF	2A	12.50	PDJU08NGNEBC	1.5P	38	10	4	001	○
9/16-18UNF	2A	14.10	PDJU09OGNEBC	1.5P	38	10	5	001	○
5/8-18UNF	2A	15.70	PDLU100GNEBC	1.5P	45	14	5	001	○
3/4-16UNF	2A	18.80	PDLU12PGNEBC	1.5P	45	14	5	001	○
7/8-14UNF	2A	22.00	PDPU14QGNEBC	1.5P	55	16	5	001	○
1-12UNF	2A	25.10	PDPU16SGNEBC	1.5P	55	16	5	001	○

G(BSP)	TCTR (tolerance)	Bar Ø (mm)	Code	THCHT (chamfer)	D (mm)	T (mm)	Clearance holes	Type	Stock
DIN 5158									
1/8-28	-	9.57	PVHG0020NEBC	2P	30	11	4	001	●
1/4-19	-	13.00	PVJG0040NEBC	2P	38	10	5	001	●
3/8-19	-	16.50	PVLG0060NEBC	2P	45	14	5	001	●
1/2-14	-	20.70	PVLG0080NEBC	2P	45	16	5	001	●
5/8-14	-	22.70	PVPG0100NEBC	2P	55	16	5	001	○
3/4-14	-	26.20	PVPG0120NEBC	2P	55	16	6	001	●
7/8-14	-	30.00	PVSG0140NEBC	2P	65	18	6	004	○
1-11	-	33.00	PVSG0160NEBC	2P	65	18	8	004	●
1 1/4-11	-	41.60	PVUG0200NEBC	2P	75	20	8	004	○
1 1/2-11	-	47.50	PVXG0240NEBC	2P	90	22	8	004	○

NPT	TCTR (tolerance)	Bar Ø (mm)	Code	THCHT (chamfer)	D (mm)	T (mm)	Clearance holes	Type	Stock
DIN 223									
1/8-27	-		PDJNT020NEBC	2P	38	10	4	017	○
1/4-18	-		PDJNT040NEBC	2P	38	15	5	017	○
3/8-18	-		PDLNT060NEBC	2P	45	15	5	017	○
1/2-14	-		PDLNT080NEBC	2P	45	19	6	017	○
3/4-14	-		PDSNT120NEBC	2P	65	20	6	019	○
1-11 1/2	-		PDSNT160NEBC	2P	65	25	8	019	○

Intro

SP

SL

PO

ST

ROLL

CARBIDE

LONG

HAND TAPS

EG (STI)

SPECIAL THREADS, GAUGES

THREAD MILLS

DIES

DIN

CENTER DRILLS

Technical info

Intro

HS-D

SP

HSS Round Dies for Automatic Lathe for Stainless Steel

SL



PO

RECOMMENDED TAPPING SPEEDS DEPENDING ON MATERIALS

ISO	Vc (m/min)	★	ISO	Vc (m/min)	★
P1	3÷5	★	M1	≤2	★
P2	≤3	★	M2	≤2	★
P7	≤2	★			

★ 1st choice ☆ suitable

ST

ROLL

CARBIDE

LONG

HAND TAPS

EG (STI)

SPECIAL THREADS, GAUGES

THREAD MILLS

DIES

JIS

CENTER DRILLS

Technical info



FEATURES

HSS material for stable and long life.
OX treatment reduces welding trouble.

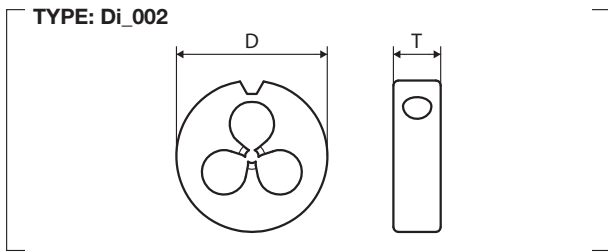

M	TCTR (tolerance)	Bar Ø (mm)	Code	THCHT (chamfer)	D (mm)	T (mm)	Clearance holes	Type	Stock
JIS									
M1X0.25	P1	0.95	HBP1.0B	2P	10	3	3	002	○
	P1	0.95	HDP1.0B	2P	16	5	3	002	○
	P2	0.95	HBQ1.0B	2P	10	3	3	002	○
	P2	0.95	HDQ1.0B	2P	16	5	3	002	○
M1.1X0.25	P1	1.05	HBP1.1B	2P	10	3	3	002	○
	P1	1.05	HDP1.1B	2P	16	5	3	002	○
	P2	1.05	HBQ1.1B	2P	10	3	3	002	○
	P2	1.05	HDQ1.1B	2P	16	5	3	002	○
M1.2X0.25	P1	1.15	HBP1.2B	2P	10	3	3	002	○
	P1	1.15	HDP1.2B	2P	16	5	3	002	○
	P2	1.15	HBQ1.2B	2P	10	3	3	002	○
	P2	1.15	HDQ1.2B	2P	16	5	3	002	○
M1.4X0.3	P1	1.34	HBP1.4C	2P	10	3	3	002	○
	P1	1.34	HDP1.4C	2P	16	5	3	002	○
	P2	1.34	HBQ1.4C	2P	10	3	3	002	○
	P2	1.34	HDQ1.4C	2P	16	5	3	002	○
M1.6X0.35	P1	1.52	HBP1.6D	2P	10	3	3	002	○
	P1	1.52	HDP1.6D	2P	16	5	3	002	○
	P2	1.52	HBQ1.6D	2P	10	3	3	002	○
	P2	1.52	HDQ1.6D	2P	16	5	3	002	○
M1.7X0.35	P1	1.63	HBP1.7D	2P	10	3	3	002	○
	P1	1.63	HDP1.7D	2P	16	5	3	002	○
	P2	1.63	HBQ1.7D	2P	10	3	3	002	○
	P2	1.63	HDQ1.7D	2P	16	5	3	002	○
M1.8X0.35	P1	1.72	HBP1.8D	2P	10	3	3	002	○
	P1	1.72	HDP1.8D	2P	16	5	3	002	○
	P2	1.72	HBQ1.8D	2P	10	3	3	002	○
	P2	1.72	HDQ1.8D	2P	16	5	3	002	○
M2X0.4	P1	1.91	HBP2.0E	2P	10	3	3	002	○
	P1	1.91	HDP2.0E	2P	16	5	4	002	○
	P1	1.91	HEP2.0E	2P	20	7	4	002	○
	P2	1.91	HBQ2.0E	2P	10	3	3	002	○
	P2	1.91	HDQ2.0E	2P	16	5	4	002	○
	P2	1.91	HEQ2.0E	2P	20	7	4	002	○
M2.2X0.45	P1	2.11	HBP2.2F	2P	10	3	3	002	○
	P1	2.11	HDP2.2F	2P	16	5	4	002	○
	P2	2.11	HBQ2.2F	2P	10	3	3	002	○
	P2	2.11	HDQ2.2F	2P	16	5	4	002	○
M2.3X0.4	P1	2.21	HBP2.3E	2P	10	3	3	002	○
	P1	2.21	HDP2.3E	2P	16	5	4	002	○
	P2	2.21	HBQ2.3E	2P	10	3	3	002	○
	P2	2.21	HDQ2.3E	2P	16	5	4	002	○

Intro

SP

SL

PO

ST

ROLL

CARBIDE

LONG

HAND TAPS

EG (STI)

SPECIAL THREADS, GAUGES

THREAD MILLS

DIES

JIS

CENTER DRILLS

Technical info

Intro

SP

SL

PO

ST

ROLL

CARBIDE

LONG

HAND
TAPS

EG (STI)

SPECIAL
THREADS,
GAUGES

THREAD
MILLS

DIES

JIS

CENTER
DRILLS

Technical
info

M	TCTR (tolerance)	Bar Ø (mm)	Code	THCHT (chamfer)	D (mm)	T (mm)	Clearance holes	Type	Stock
JIS									
M2.5X0.45	P1	2.41	HBP2.5F	2P	10	3	3	002	○
	P1	2.41	HDP2.5F	2P	16	5	4	002	○
	P1	2.41	HEP2.5F	2P	20	7	4	002	○
	P2	2.41	HBQ2.5F	2P	10	3	3	002	○
	P2	2.41	HDQ2.5F	2P	16	5	4	002	○
	P2	2.41	HEQ2.5F	2P	20	7	4	002	○
M2.6X0.45	P1	2.51	HBP2.6F	2P	10	3	3	002	○
	P1	2.51	HDP2.6F	2P	16	5	4	002	○
	P1	2.51	HEP2.6F	2P	20	7	4	002	○
	P2	2.51	HBQ2.6F	2P	10	3	3	002	○
	P2	2.51	HDQ2.6F	2P	16	5	4	002	○
	P2	2.51	HEQ2.6F	2P	20	7	4	002	○
M3X0.5	P1	2.90	HDP3.0G	2P	16	5	4	002	○
	P1	2.90	HEP3.0G	2P	20	7	4	002	○
	P2	2.90	HDQ3.0G	2P	16	5	4	002	○
	P2	2.90	HEQ3.0G	2P	20	7	4	002	○
M3.5X0.6	P1	3.39	HDP3.5H	2P	16	5	4	002	○
	P1	3.39	HEP3.5H	2P	20	7	4	002	○
	P2	3.39	HDQ3.5H	2P	16	5	4	002	○
	P2	3.39	HEQ3.5H	2P	20	7	4	002	○
M4X0.7	P1	3.87	HDP4.0I	2P	16	5	4	002	○
	P1	3.87	HEP4.0I	2P	20	7	4	002	○
	P2	3.87	HDQ4.0I	2P	16	5	4	002	○
	P2	3.87	HEQ4.0I	2P	20	7	4	002	○
M5X0.8	P1	4.86	HEP5.0K	2P	20	7	4	002	○
	P2	4.86	HEQ5.0K	2P	20	7	4	002	○
M6X1	P1	5.86	HEP6.0M	2P	20	7	4	002	○
	P2	5.86	HEQ6.0M	2P	20	7	4	002	○
M8X1.25	P1	7.83	HEP8.0N	2P	20	7	5	002	○
	P1	7.83	HGP8.0N	2P	25	9	4	002	○
	P2	7.83	HEQ8.0N	2P	20	7	5	002	○
	P2	7.83	HGQ8.0N	2P	25	9	4	002	○
M10X1.5	P1	9.82	HGP0100	2P	25	9	5	002	○
	P2	9.82	HGQ0100	2P	25	9	5	002	○
MF									
JIS									
M2X0.25	P1	1.94	HBP2.0B	2P	10	3	3	002	○
	P1	1.94	HDP2.0B	2P	16	5	4	002	○
	P2	1.94	HBQ2.0B	2P	10	3	3	002	○
	P2	1.94	HDQ2.0B	2P	16	5	4	002	○
M2.5X0.35	P1	2.42	HBP2.5D	2P	10	3	3	002	○
	P1	2.42	HDP2.5D	2P	16	5	4	002	○
	P2	2.42	HBQ2.5D	2P	10	3	3	002	○
	P2	2.42	HDQ2.5D	2P	16	5	4	002	○

MF	TCTR (tolerance)	Bar Ø (mm)	Code	THCHT (chamfer)	D (mm)	T (mm)	Clearance holes	Type	Stock
JIS									
M2.6X0.35	P1	2.51	HBP2.6D	2P	10	3	3	002	○
	P1	2.51	HDP2.6D	2P	16	5	4	002	○
	P2	2.51	HBQ2.6D	2P	10	3	3	002	○
	P2	2.51	HDQ2.6D	2P	16	5	4	002	○
M3X0.35	P1	2.91	HDP3.0D	2P	16	5	4	002	○
	P1	2.91	HEP3.0D	2P	20	7	4	002	○
	P2	2.91	HDQ3.0D	2P	16	5	4	002	○
	P2	2.91	HEQ3.0D	2P	20	7	4	002	○
M4X0.5	P1	3.89	HDP4.0G	2P	16	5	4	002	○
	P1	3.89	HEP4.0G	2P	20	7	4	002	○
	P2	3.89	HDQ4.0G	2P	16	5	4	002	○
	P2	3.89	HEQ4.0G	2P	20	7	4	002	○
M5X0.5	P1	4.89	HEP5.0G	2P	20	7	4	002	○
	P2	4.89	HEQ5.0G	2P	20	7	4	002	○
M6X0.75	P1	5.88	HEP6.0J	2P	20	7	4	002	○
	P2	5.88	HEQ6.0J	2P	20	7	4	002	○
M6X0.5	P1	5.90	HEP6.0G	2P	20	7	4	002	○
	P2	5.90	HEQ6.0G	2P	20	7	4	002	○
M7X0.75	P1	6.88	HEP7.0J	2P	20	7	4	002	○
	P2	6.88	HEQ7.0J	2P	20	7	4	002	○
M7X0.5	P1	6.90	HEP7.0G	2P	20	7	4	002	○
	P2	6.90	HEQ7.0G	2P	20	7	4	002	○
M8X1	P1	7.87	HEP8.0M	2P	20	7	5	002	○
	P1	7.87	HGP8.0M	2P	25	9	4	002	○
	P2	7.87	HEQ8.0M	2P	20	7	5	002	○
	P2	7.87	HGQ8.0M	2P	25	9	4	002	○
M8X0.75	P1	7.87	HEP8.0J	2P	20	7	5	002	○
	P1	7.87	HGP8.0J	2P	25	9	4	002	○
	P2	7.87	HEQ8.0J	2P	20	7	5	002	○
	P2	7.87	HGQ8.0J	2P	25	9	4	002	○
M8X0.5	P1	7.89	HEP8.0G	2P	20	7	5	002	○
	P2	7.89	HEQ8.0G	2P	20	7	5	002	○
M9X1	P1	8.87	HEP9.0M	2P	20	7	5	002	○
	P2	8.87	HEQ9.0M	2P	20	7	5	002	○
M9X0.75	P1	8.87	HEP9.0J	2P	20	7	5	002	○
	P2	8.87	HEQ9.0J	2P	20	7	5	002	○
M10X1.25	P1	9.85	HGP010N	2P	25	9	5	002	○
	P2	9.85	HGQ010N	2P	25	9	5	002	○
M10X1	P1	9.86	HGP010M	2P	25	9	5	002	○
	P2	9.86	HGQ010M	2P	25	9	5	002	○

Intro

SP

SL

PO

ST

ROLL

CARBIDE

LONG

HAND TAPS

EG (STI)

SPECIAL THREADS, GAUGES

THREAD MILLS

DIES

JIS

CENTER DRILLS

Technical info

CENTER DRILLS



CD - DIN **606**
CD - YMW **608**

Selection Chart

Intro

SP

SL

PO

ST

ROLL

CARBIDE

LONG

HAND TAPS

EG (STI)









SPECIAL THREADS, GAUGES

THREAD MILLS

DIES

CENTER DRILLS

Technical info

Center Drills								
CD-A	CD-SL	CD-R	AUCES	AUCDS	MHCDS	NC-SD V	AUPEQ	
HSS	HSS	HSS	HSS COATING	HSS COATING	HSS-Co COATING	HSS-Co COATING	HSS COATING	
								
DIN 606	YMW 609	DIN 607	YMW 611	YMW 613	YMW 615	YMW 617	YMW 619	
Application field								
P1	★	★	★	★	★		★	★
P2	★	★	★	★	★	★	★	★
P3	★	★	★	★	★	★	★	★
P4					★	★	★	★
P5						★		
P6								
P7	☆	☆	☆	★	☆		★	★
P8								
M1	☆	☆	☆	★	☆		★	★
M2	☆	☆	☆	★	☆		★	★
M3								
K1	☆	☆	☆	☆	★		★	★
K2	☆	☆	☆	☆	★		★	★
K3								
K4								
N1	☆	☆	☆	★	☆		★	★
N2	☆	☆	☆	★	☆		★	★
N3	☆	☆	☆	★	☆		★	★
N4	☆	☆	☆	★	☆		★	★
N5								
S1 (<25 HRC)								
S2 (<35 HRC)								
S3 (35 ÷ 45 HRC)								
S5								
H (45 ÷ 55 HRC)								
H (55 ÷ 63 HRC)								

★ 1st choice ☆ suitable

Center Drills

AUPES

HSS

COATING



YMW

621

Application field

★	P1
★	P2
★	P3
★	P4
	P5
	P6
★	P7
	P8
★	M1
★	M2
	M3
★	K1
★	K2
	K3
	K4
★	N1
★	N2
★	N3
★	N4
	N5
	S1 (<35 HRC)
	S2 (<35 HRC)
	S3 (35 ÷ 45 HRC)
	S5
	H (45 ÷ 55 HRC)
	H (55 ÷ 63 HRC)

Intro

SP

SL

PO

ST

ROLL

CARBIDE

LONG

HAND TAPS

EG (STI)

SPECIAL THREADS, GAUGES

THREAD MILLS

DIES

CENTER DRILLS

Technical info

Intro

CD-A



SP

Low helix center drills A type 60°

SL

HSS

FEATURES

Low helix type A.
For middle hardness materials.

PO

ST

ROLL

CARBIDE

LONG

HAND TAPS

EG (STI)

SPECIAL THREADS, GAUGES

THREAD MILLS

DIES

CENTER DRILLS

DIN

Technical info

	P1	P2	P3	M1 M2 P7
Work-materials	Low carbon steel	Carbon and low alloy steel	Medium alloy steel	Stainless steel
Vc (m/min)	15÷30	15÷30	10÷25	5÷12
DC	fn (mm/rev)	fn (mm/rev)	fn (mm/rev)	fn (mm/rev)
1	0.02÷0.07	0.02÷0.07	0.02÷0.07	0.02÷0.07
1.5	0.02÷0.07	0.02÷0.07	0.02÷0.07	0.02÷0.07
2	0.02÷0.07	0.02÷0.07	0.02÷0.07	0.02÷0.07
2.5	0.02÷0.07	0.02÷0.07	0.02÷0.07	0.02÷0.07
3	0.04÷0.12	0.04÷0.12	0.04÷0.12	0.04÷0.12
4	0.04÷0.12	0.04÷0.12	0.04÷0.12	0.04÷0.12
5	0.06÷0.17	0.06÷0.17	0.06÷0.17	0.06÷0.17
6.3	0.06÷0.17	0.06÷0.17	0.06÷0.17	0.06÷0.17
8	0.10÷0.20	0.10÷0.20	0.10÷0.20	0.10÷0.20
10	0.10÷0.20	0.10÷0.20	0.10÷0.20	0.10÷0.20

TYPE: CD_001

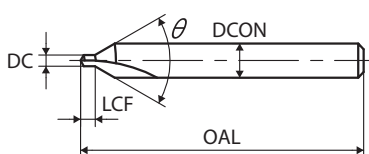

TYPE: CD_002

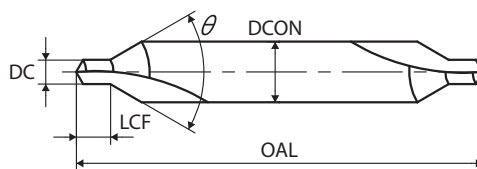
DC x θ x DCON

Code

DC (mm)

DCON (mm)

OAL (mm)

LCF (mm)

Type

Stock

DIN 333

0.5 x 60° x 3.15	00210.5	0.5	3.15	25	0.8	001	●
0.8 x 60° x 3.15	00210.8	0.8	3.15	25	1.1	001	○
1 x 60° x 3.15	00211.0	1	3.15	31.5	1.3	002	●
1.25 x 60° x 3.15	00211.2	1.25	3.15	31.5	1.6	002	○
1.6 x 60° x 4	00211.6	1.6	4	35.5	2	002	●
2 x 60° x 5	00212.0	2	5	40	2.5	002	●
2.5 x 60° x 6.3	00212.5	2.5	6.3	45	3.1	002	●
3.15 x 60° x 8	00213.1	3.15	8	50	3.9	002	●
4 x 60° x 10	00214.0	4	10	56	5	002	●
5 x 60° x 12.5	00215.0	5	12.5	63	6.3	002	●
6.3 x 60° x 16	00216.3	6.3	16	71	8	002	●
8 x 60° x 20	00218.0	8	20	80	10.1	002	●
10 x 60° x 25	0021010	10	25	100	12.8	002	●

CD-R



Intro

Low helix center drills R type

HSS

FEATURES

Low helix type R.
For middle hardness materials.

	P1	P2	P3	M1 M2 P7
Work-materials	Low carbon steel	Carbon and low alloy steel	Medium alloy steel	Stainless steel
Vc (m/min)	15÷30	15÷30	10÷25	5÷12
DC	fn (mm/rev)	fn (mm/rev)	fn (mm/rev)	fn (mm/rev)
1	0.02÷0.07	0.02÷0.07	0.02÷0.07	0.02÷0.07
1.5	0.02÷0.07	0.02÷0.07	0.02÷0.07	0.02÷0.07
2	0.02÷0.07	0.02÷0.07	0.02÷0.07	0.02÷0.07
2.5	0.02÷0.07	0.02÷0.07	0.02÷0.07	0.02÷0.07
3	0.04÷0.12	0.04÷0.12	0.04÷0.12	0.04÷0.12
4	0.04÷0.12	0.04÷0.12	0.04÷0.12	0.04÷0.12
5	0.06÷0.17	0.06÷0.17	0.06÷0.17	0.06÷0.17
6.3	0.06÷0.17	0.06÷0.17	0.06÷0.17	0.06÷0.17
8	0.10÷0.20	0.10÷0.20	0.10÷0.20	0.10÷0.20
10	0.10÷0.20	0.10÷0.20	0.10÷0.20	0.10÷0.20

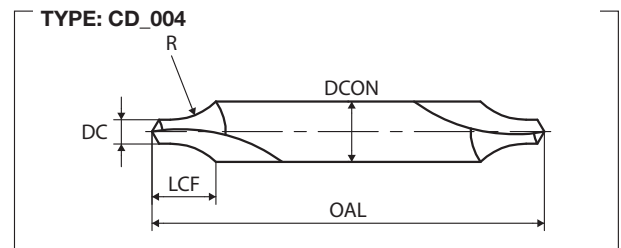
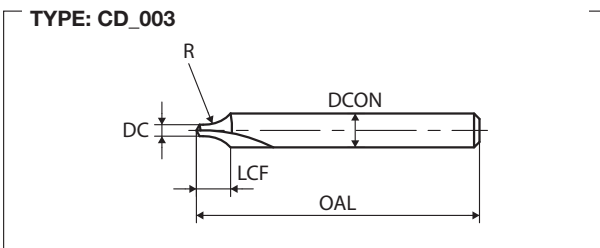

DC x R x DCON	Code	DC (mm)	DCON (mm)	OAL (mm)	LCF (mm)	Rmax (mm)	Rmin (mm)	Type	Stock
DIN 333									
0.5 x R x 3.15	00230.5	0.5	3.15	25	2.12	1.6	1.25	003	○
0.8 x R x 3.15	00230.8	0.8	3.15	25	2.65	2.5	2	003	○
1 x R x 3.15	00231.0	1	3.15	31.5	3	3.15	2.5	004	○
1.25 x R x 3.15	00231.2	1.25	3.15	31.5	3.35	4	3.15	004	○
1.6 x R x 4	00231.6	1.6	4	35.5	4.25	5	4	004	○
2 x R x 5	00232.0	2	5	40	5.3	6.3	5	004	●
2.5 x R x 6.3	00232.5	2.5	6.3	45	6.7	8	6.3	004	●
3.15 x R x 8	00233.1	3.15	8	50	8.5	10	8	004	●
4 x R x 10	00234.0	4	10	56	10.6	12.5	10	004	●
5 x R x 12.5	00235.0	5	12.5	63	13.2	16	12.5	004	●
6.3 x R x 16	00236.3	6.3	16	71	17	20	16	004	●
8 x R x 20	00238.0	8	20	80	21.2	25	20	004	○
10 x R x 25	0023010	10	25	100	26.5	31.5	25	004	●

SP

SL

PO

ST

ROLL

CARBIDE

LONG

HAND TAPS

EG (STI)

SPECIAL THREADS, GAUGES

THREAD MILLS

DIES

CENTER DRILLS
DIN

Technical info

Intro

CD-SL

SP

Long Shank Low Helix Center Drills-Type A 60°

SL

HSS

PO

ST

ROLL

CARBIDE

LONG

HAND
TAPS

EG (STI)

SPECIAL
THREADS,
GAUGES

THREAD
MILLS

DIES

CENTER
DRILLS
YMW

Technical
info



FEATURES

Long shank and low helix type A.
For middle hardness materials.

	P1	P2	P3	M1 M2 P7
Work-materials	Low carbon steel	Carbon and low alloy steel	Medium alloy steel	Stainless steel
Vc (m/min)	15÷30	15÷30	10÷25	5÷12
DC	fn (mm/rev)	fn (mm/rev)	fn (mm/rev)	fn (mm/rev)
1	0.02÷0.07	0.02÷0.07	0.02÷0.07	0.02÷0.07
1.5	0.02÷0.07	0.02÷0.07	0.02÷0.07	0.02÷0.07
2	0.02÷0.07	0.02÷0.07	0.02÷0.07	0.02÷0.07
2.5	0.02÷0.07	0.02÷0.07	0.02÷0.07	0.02÷0.07
3	0.04÷0.12	0.04÷0.12	0.04÷0.12	0.04÷0.12
4	0.04÷0.12	0.04÷0.12	0.04÷0.12	0.04÷0.12
5	0.06÷0.17	0.06÷0.17	0.06÷0.17	0.06÷0.17
6.3	0.06÷0.17	0.06÷0.17	0.06÷0.17	0.06÷0.17
8	0.10÷0.20	0.10÷0.20	0.10÷0.20	0.10÷0.20
10	0.10÷0.20	0.10÷0.20	0.10÷0.20	0.10÷0.20

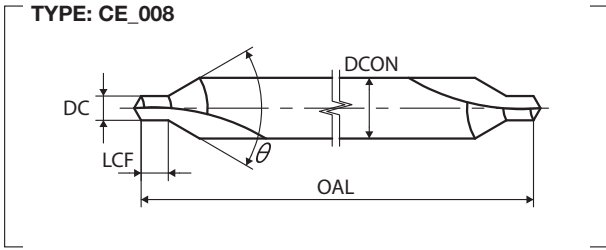

DC x θ x DCON	Code	DC (mm)	DCON (mm)	OAL (mm)	LCF (mm)	Type	Stock
YMW							
1 x 60° x 4	CDL1.0	1	4	100	1	008	○
	CDM1.0	1	4	150	1	008	○
1.5 x 60° x 5	CDL1.5	1.5	5	100	1.5	008	○
	CDM1.5	1.5	5	150	1.5	008	○
2 x 60° x 6	CDL2.0	2	6	100	2	008	●
	CDM2.0	2	6	150	2	008	○
2.5 x 60° x 8	CDL2.5	2.5	8	100	2.5	008	●
	CDM2.5	2.5	8	150	2.5	008	○
3 x 60° x 8	CDL3.0	3	8	100	3	008	●
	CDM3.0	3	8	150	3	008	○
	CDN3.0	3	8	200	3	008	○
4 x 60° x 10	CDL4.0	4	10	100	4.5	008	●
	CDM4.0	4	10	150	4.5	008	○
	CDN4.0	4	10	200	4.5	008	○
5 x 60° x 12	CDL5.0	5	12	100	5.5	008	●
	CDM5.0	5	12	150	5.5	008	○
	CDN5.0	5	12	200	5.5	008	○

Intro

SP

SL

PO

ST

ROLL

CARBIDE

LONG

HAND TAPS

EG (STI)

SPECIAL THREADS, GAUGES

THREAD MILLS

DIES

CENTER DRILLS
YMW

Technical info

Intro

AUCES



SP

High helical fluted A type 60° Single-Ended Center Drills, Coated

SL



FEATURES

Easy positioning and high precision machining.
High helix for low hardness workpiece materials.

PO

ST

ROLL

CARBIDE

LONG

HAND TAPS

EG (STI)

SPECIAL THREADS, GAUGES

THREAD MILLS

DIES

CENTER DRILLS
YMW

Technical
info

	P1	P2	P3	M1 M2 P7	K1	K2	N1	N2 N4	N3
Work-materials	Low carbon steel	Carbon and low alloy steel	Medium alloy steel	Stainless steel	Grey cast iron	Nodular cast iron	Aluminium	Aluminium die cast	Copper
Vc (m/min)	15÷40	20÷40	20÷40	10÷20	20÷40	20÷40	20÷40	20÷40	20÷40
DC	fn (mm/rev)	fn (mm/rev)	fn (mm/rev)	fn (mm/rev)	fn (mm/rev)	fn (mm/rev)	fn (mm/rev)	fn (mm/rev)	fn (mm/rev)
1	0.02÷0.07	0.02÷0.07	0.02÷0.07	0.02÷0.07	0.02÷0.07	0.02÷0.07	0.02÷0.07	0.02÷0.07	0.02÷0.07
1.5	0.02÷0.07	0.02÷0.07	0.02÷0.07	0.02÷0.07	0.02÷0.07	0.02÷0.07	0.02÷0.07	0.02÷0.07	0.02÷0.07
2	0.02÷0.07	0.02÷0.07	0.02÷0.07	0.02÷0.07	0.02÷0.07	0.02÷0.07	0.02÷0.07	0.02÷0.07	0.02÷0.07
2.5	0.02÷0.07	0.02÷0.07	0.02÷0.07	0.02÷0.07	0.02÷0.07	0.02÷0.07	0.02÷0.07	0.02÷0.07	0.02÷0.07
3	0.04÷0.12	0.04÷0.12	0.04÷0.12	0.04÷0.12	0.04÷0.12	0.04÷0.12	0.04÷0.12	0.04÷0.12	0.04÷0.12
4	0.04÷0.12	0.04÷0.12	0.04÷0.12	0.04÷0.12	0.04÷0.12	0.04÷0.12	0.04÷0.12	0.04÷0.12	0.04÷0.12
5	0.06÷0.17	0.06÷0.17	0.06÷0.17	0.06÷0.17	0.06÷0.17	0.06÷0.17	0.06÷0.17	0.06÷0.17	0.06÷0.17
6	0.06÷0.17	0.06÷0.17	0.06÷0.17	0.06÷0.17	0.06÷0.17	0.06÷0.17	0.06÷0.17	0.06÷0.17	0.06÷0.17

Product Features



Higher DC and DCON accuracy for great improvement in drilling precision and surface roughness



Shorter LCF for higher speed and feed

DOUBLE-ENDED TYPE

Smaller flexibility in the overhang portion
Minimum clamping length

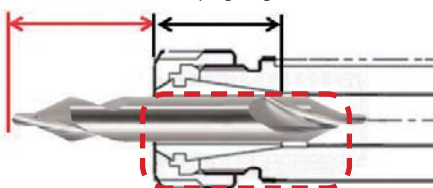

SINGLE-ENDED TYPE

The extended shank gives more overhang flexibility
Minimum clamping length

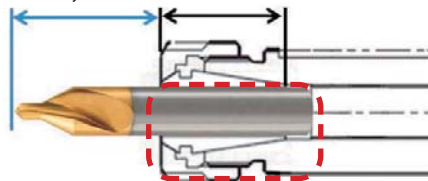

Process Data

PRODUCT	AUCES, single-ended Coated Center Drills	Market alternative, double-ended Coated Center Drills
Size	Ø3x60°x8	
Workpiece material	Ck50 (96-98HRB)	
Drilling speed	30m/min	10m/min
Feed	0.12mm/rev	0.05mm/rev
Drilling length	6mm	6.5mm
Lubricant	Water soluble oil (x20)	
Machine	Machining center vertical type	

Conditions	AUCES	Market alternative
Ck50 Cutting Speed: 10m/min Feed:0.5mm/rev		
Ck50 Cutting Speed: 30m/min Feed:0.12mm/rev		

Size	Ø1x60°x4
Workpiece material	Ck50
Drilling Length	30m/min
Feed	0.04mm/rev
Lubricant	Water soluble oil (x20)
Machine	Machining center vertical type

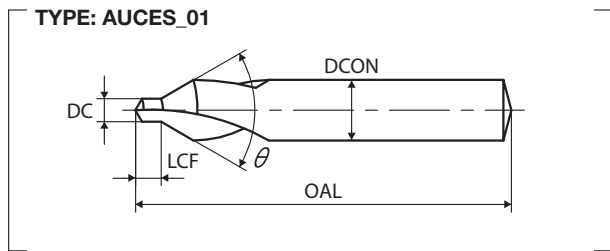

DC x θ x DCON	Code	DC (mm)	DCON (mm)	OAL (mm)	LCF (mm)	Type	Stock
YMW							
1 x 60° x 4	YH61.00ZNEVD	1	4	35	1.1	01	●
1.5 x 60° x 5	YH61.50ZNEVE	1.5	5	40	1.6	01	●
2 x 60° x 6	YH62.00ZNEVF	2	6	45	2.1	01	●
2.5 x 60° x 8	YH62.50ZNEVI	2.5	8	50	2.7	01	●
3 x 60° x 8	YH63.00ZNEVI	3	8	50	3.2	01	●
4 x 60° x 10	YH64.00ZNEVJ	4	10	55	4.3	01	●
5 x 60° x 12	YH65.00ZNEVM	5	12	65	5.3	01	●
6 x 60° x 16	YH66.00ZNEVP	6	16	70	6.4	01	●

- Intro
- SP
- SL
- PO
- ST
- ROLL
- CARBIDE
- LONG
- HAND TAPS
- EG (STI)
- SPECIAL THREADS, GAUGES
- THREAD MILLS
- DIES
- CENTER DRILLS
YMW
- Technical info

Intro

AUCDS



SP

Low helical fluted A type 60° Single-Ended Center Drills, Coated

SL



FEATURES

Easy positioning and high precision machining.
Low helix for medium hardness workpiece materials.

PO

	P2	P3	P4	K1	K2
Work-materials	Carbon and low alloy steel	Medium alloy steel	High alloy	Grey cast iron	Nodular cast iron
Vc (m/min)	20÷40	20÷40	30÷40	10÷40	10÷40
DC	fn (mm/rev)	fn (mm/rev)	fn (mm/rev)	fn (mm/rev)	fn (mm/rev)
1	0.02÷0.07	0.02÷0.07	0.02÷0.07	0.02÷0.07	0.02÷0.07
1.5	0.02÷0.07	0.02÷0.07	0.02÷0.07	0.02÷0.07	0.02÷0.07
2	0.02÷0.07	0.02÷0.07	0.02÷0.07	0.02÷0.07	0.02÷0.07
2.5	0.02÷0.07	0.02÷0.07	0.02÷0.07	0.02÷0.07	0.02÷0.07
3	0.04÷0.12	0.04÷0.12	0.04÷0.12	0.04÷0.12	0.04÷0.12
4	0.04÷0.12	0.04÷0.12	0.04÷0.12	0.04÷0.12	0.04÷0.12
5	0.06÷0.17	0.06÷0.17	0.06÷0.17	0.06÷0.17	0.06÷0.17
6	0.06÷0.17	0.06÷0.17	0.06÷0.17	0.06÷0.17	0.06÷0.17

LONG

Product Features

HAND TAPS

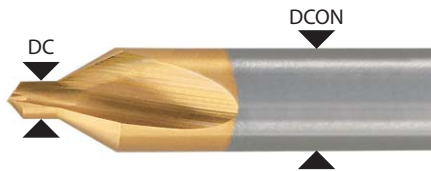

Higher DC and DCON accuracy for great improvement in drilling precision and surface roughness

EG (STI)

SPECIAL THREADS, GAUGES



Shorter LCF for higher speed and feed

THREAD MILLS

DIES

DOUBLE-ENDED TYPE

Smaller flexibility in the overhang portion
Minimum clamping length

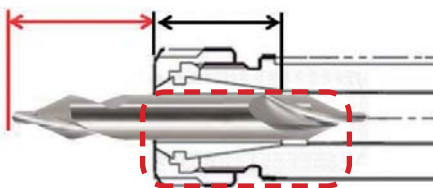

SINGLE-ENDED TYPE

The extended shank gives more overhang flexibility
Minimum clamping length

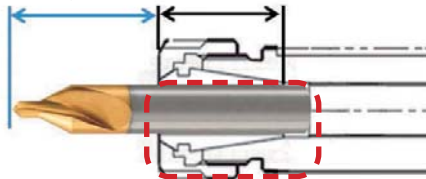

CENTER DRILLS
YMW

Technical info

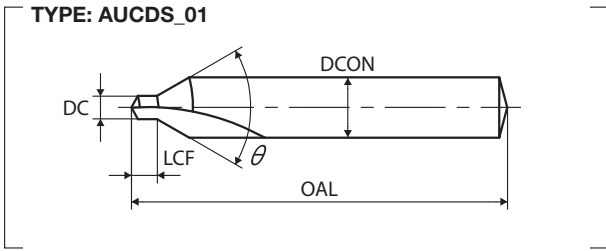

DC x θ x DCON	Code	DC (mm)	DCON (mm)	OAL (mm)	LCF (mm)	Type	Stock
YMW							
1 x 60° x 4	YL61.00ZNEVD	1	4	35	1.1	01	●
1.5 x 60° x 5	YL61.50ZNEVE	1.5	5	40	1.6	01	●
2 x 60° x 6	YL62.00ZNEVF	2	6	45	2.1	01	●
2.5 x 60° x 8	YL62.50ZNEVI	2.5	8	50	2.7	01	●
3 x 60° x 8	YL63.00ZNEVI	3	8	50	3.2	01	●
4 x 60° x 10	YL64.00ZNEVJ	4	10	55	4.3	01	●
5 x 60° x 12	YL65.00ZNEVM	5	12	65	5.3	01	●
6 x 60° x 16	YL66.00ZNEVP	6	16	70	6.4	01	●

Intro

SP

SL

PO

ST

ROLL

CARBIDE

LONG

HAND TAPS

EG (STI)

SPECIAL THREADS, GAUGES

THREAD MILLS

DIES

CENTER DRILLS
YMW

Technical info

Intro

MHCDS



SP

Center Drills for Medium Hardness Carbon Steel for High Speed machining, HSSCo Coated

SL

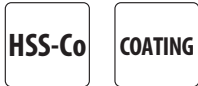

FEATURES

Single-ended center drills for high accuracy in center hole drilling.

Easy positioning and high precision machining.

HSSCo and special coating for long and stable life even on medium hard materials.

PO

ST

	P2	P3 P4
Work-materials	Carbon and low alloy steel	Medium alloy steel
Vc (m/min)	30÷45	30÷45
DC	fn (mm/rev)	fn (mm/rev)
1	0.10	0.10
1.5	0.10	0.10
2	0.15	0.15
2.5	0.15	0.15
3	0.15	0.15
4	0.20	0.20
5	0.20	0.20
6	0.20	0.20

ROLL

CARBIDE

LONG

Cutting Data

HAND TAPS

EG (STI)

SPECIAL THREADS, GAUGES

THREAD MILLS

DIES

CENTER DRILLS
YMW

Technical info

Great extension of tool life with MHCDS

The pictures on the right show the different damage of MHCDS and a market alternative cutting edge after 480 holes machined at the same cutting condition. As shown, the MHCDS has smaller wear and edge damage allowing the MHCDS to run much further than a standard center drill.

Cutting Condition

Size: 3x60°x8
Material: Ck60 - 1.1221
Machine: NC lathe
Cutting speed: 30m/min
Feed: 0.15mm/rev
Lubricant : water soluble oil



Market alternative

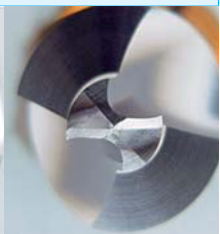

MHCDS

Great improvement in surface roughness and circularity with MHCDS

Enlarged picture

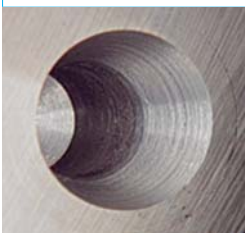

Under the cutting condition stated above, the surface finish of center-drilled hole has been greatly improved. Circularity of center drilled hole as well as run-out tolerance of turning axis has been improved.

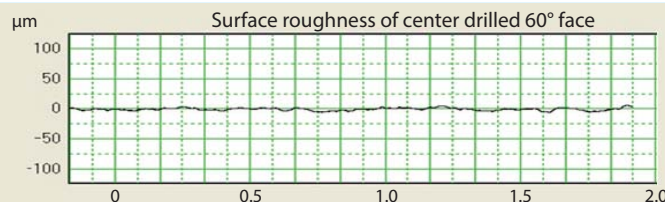

Circularity of center drilled 60° face

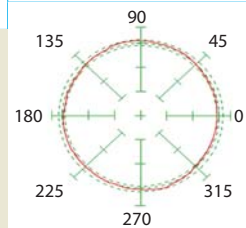

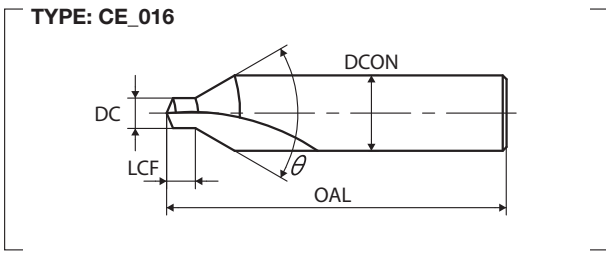

DC x θ x DCON	Code	DC (mm)	DCON (mm)	OAL (mm)	LCF (mm)	Type	Stock
YMW							
1 x 60° x 4	VMHCD1.0S	1	4	30	1	016	●
1.5 x 60° x 5	VMHCD1.5S	1.5	5	30	1.5	016	●
2 x 60° x 6	VMHCD2.0S	2	6	30	1.9	016	●
2.5 x 60° x 8	VMHCD2.5S	2.5	8	40	2.4	016	●
3 x 60° x 8	VMHCD3.0S	3	8	40	2.8	016	●
4 x 60° x 10	VMHCD4.0S	4	10	45	3.8	016	●
5 x 60° x 12	VMHCD5.0S	5	12	55	4.6	016	●
6 x 60° x 16	VMHCD6.0S	6	16	65	5.5	016	●

Intro

SP

SL

PO

ST

ROLL

CARBIDE

LONG

HAND TAPS

EG (STI)

SPECIAL THREADS, GAUGES

THREAD MILLS

DIES

CENTER DRILLS
YMW

Technical info

Intro

NC-SD V



SP

NC Starting Drills for Chamfering (90°) and Center Positioning (125°), Coated

SL

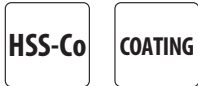

FEATURES

90° type for hole chamfering.
125° for center positioning, improves drill performance.
HSSCo and special coating for stable and long life.

PO

ST

ROLL

CARBIDE

	P1	P2	P3	M1 M2 P7	K1	K2	N1	N2 N3 N4
Work-materials	Low carbon steel	Carbon and low alloy steel	Medium alloy steel	Stainless steel	Grey cast iron	Nodular cast iron	Aluminium	Aluminium die cast
Vc (m/min)	25÷40	25÷32	15÷25	7÷12	20÷35	20÷35	60÷90	60÷90
DC	fn (mm/rev)	fn (mm/rev)	fn (mm/rev)	fn (mm/rev)	fn (mm/rev)	fn (mm/rev)	fn (mm/rev)	fn (mm/rev)
1	0.03÷0.06	0.03÷0.06	0.03÷0.06	0.03÷0.06	0.03÷0.06	0.03÷0.06	0.03÷0.06	0.03÷0.06
1.5	0.05÷0.10	0.05÷0.10	0.05÷0.10	0.05÷0.10	0.05÷0.10	0.05÷0.10	0.05÷0.10	0.05÷0.10
2	0.08÷0.15	0.08÷0.15	0.08÷0.15	0.08÷0.15	0.08÷0.15	0.08÷0.15	0.08÷0.15	0.08÷0.15
2.5	0.10÷0.18	0.10÷0.18	0.10÷0.18	0.10÷0.18	0.10÷0.18	0.10÷0.18	0.10÷0.18	0.10÷0.18
3	0.15÷0.20	0.15÷0.20	0.15÷0.20	0.15÷0.20	0.15÷0.20	0.15÷0.20	0.15÷0.20	0.15÷0.20
4	0.15÷0.25	0.15÷0.25	0.15÷0.25	0.15÷0.25	0.15÷0.25	0.15÷0.25	0.15÷0.25	0.15÷0.25
5	0.15÷0.30	0.15÷0.30	0.15÷0.30	0.15÷0.30	0.15÷0.30	0.15÷0.30	0.15÷0.30	0.15÷0.30
6	0.20÷0.30	0.20÷0.30	0.20÷0.30	0.20÷0.30	0.20÷0.30	0.20÷0.30	0.20÷0.30	0.20÷0.30

LONG

HAND TAPS

EG (STI)

Normal drill

NC-SD V 90°

Drilling process is finished.

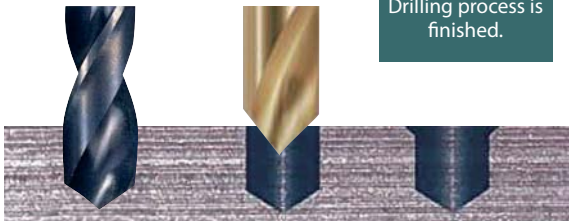

NC-SD 125°

Normal drill

Drilling process is finished.



Difference between starting drills and center drills

For positioning, center drills can also be used. However in the case of center drill, since cutting edge of normal drill first hits the material, this can cause chipping on cutting edge and slant drilling.



SPECIAL THREADS, GAUGES

THREAD MILLS

DIES

CENTER DRILLS
YMW

Technical info

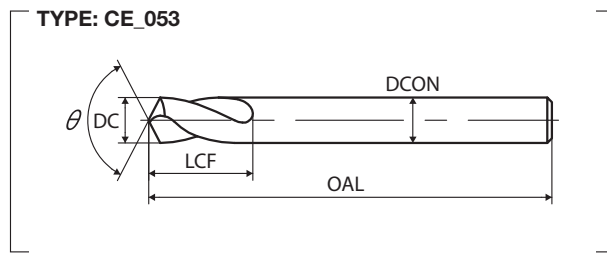
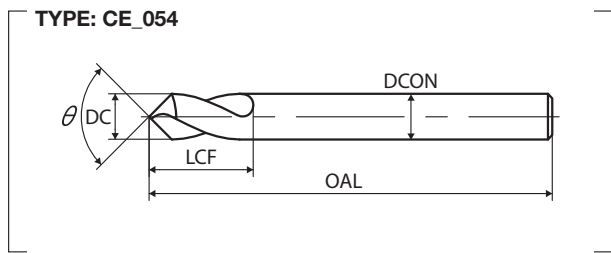

DC x θ x DCON	Code	DC (mm)	DCON (mm)	OAL (mm)	LCF (mm)	Type	Stock
YMW							
3 x 90°	CS-D3.0QTI	3	3	46	10	054	●
4 x 90°	CS-D4.0QTI	4	4	55	12	054	●
5 x 90°	CS-D5.0QTI	5	5	62	13	054	●
6 x 90°	CS-D6.0QTI	6	6	66	15	054	●
8 x 90°	CS-D8.0QTI	8	8	79	20	054	●
10 x 90°	CS-D010QTI	10	10	89	23	054	●
12 x 90°	CS-D012QTI	12	12	102	26	054	●
16 x 90°	CS-D016QTI	16	16	115	32	054	●
20 x 90°	CS-D020QTI	20	20	131	40	054	●
25 x 90°	CS-D025QTI	25	25	151	50	054	○

DC x θ x DCON	Code	DC (mm)	DCON (mm)	OAL (mm)	LCF (mm)	Type	Stock
YMW							
3 x 125°	CS-D3.0TI	3	3	46	10	053	○
4 x 125°	CS-D4.0TI	4	4	55	12	053	○
5 x 125°	CS-D5.0TI	5	5	62	13	053	○
6 x 125°	CS-D6.0TI	6	6	66	15	053	●
8 x 125°	CS-D8.0TI	8	8	79	20	053	●
10 x 125°	CS-D010TI	10	10	89	23	053	●
12 x 125°	CS-D012TI	12	12	102	26	053	●
16 x 125°	CS-D016TI	16	16	115	32	053	●

Intro

SP

SL

PO

ST

ROLL

CARBIDE

LONG

HAND TAPS

EG (STI)

SPECIAL THREADS, GAUGES

THREAD MILLS

DIES

CENTER DRILLS
YMW

Technical info

Intro

AUPEQ



SP

Single-Ended Point Drills PE-90°, Coated

SL



FEATURES

For positioning, chamfering hole, chamfering outer edge and V slotting.

HSS and special coating for high speed machining and excellent surface finishing.

PO

ST

ROLL

CARBIDE

	P1		P2		P3		P4		M1 M2 P7		N1 N2	
Workpiece Material	Soft Steels St.44-2 - 1.0044		Carbon steels Ck50 - 1.1206		Alloy steels 42CrMo4 - 1.7225		Thermal refined steels		Stainless steels AISI304 - 1.4301 - X5CrNi18-9		Aluminium alloy castings G-AISI8Cu3 - A380	
Vc (m/min)	38÷48		28÷38		26÷33		13÷17		13÷20		84÷120	
Diameter (mm)	RPM	Feed (mm/rev)	RPM	Feed (mm/rev)	RPM	Feed (mm/rev)	RPM	Feed (mm/rev)	RPM	Feed (mm/rev)	RPM	Feed (mm/rev)
3	4550	0.04÷0.08	3500	0.04÷0.08	3150	0.04÷0.08	1800	0.03÷0.06	1750	0.04÷0.08	10800	0.10÷0.22
4	3400	0.05÷0.10	2650	0.05÷0.10	2350	0.05÷0.10	1200	0.04÷0.08	1300	0.05÷0.10	8100	0.12÷0.26
6	2300	0.06÷0.12	1750	0.06÷0.12	1550	0.06÷0.12	800	0.05÷0.10	900	0.06÷0.12	5400	0.15÷0.30
8	1700	0.08÷0.15	1300	0.08÷0.15	1150	0.08÷0.15	600	0.06÷0.12	650	0.08÷0.15	4050	0.18÷0.35
10	1350	0.10÷0.18	1050	0.10÷0.18	950	0.10÷0.18	500	0.08÷0.15	500	0.10÷0.18	3250	0.21÷0.40
12	1150	0.12÷0.22	900	0.12÷0.22	800	0.12÷0.22	400	0.10÷0.18	450	0.12÷0.22	2700	0.25÷0.45
16	850	0.16÷0.26	650	0.16÷0.26	600	0.16÷0.26	300	0.12÷0.22	350	0.16÷0.26	2050	0.32÷0.50
20	700	0.20÷0.35	500	0.20÷0.35	450	0.20÷0.35	250	0.16÷0.26	250	0.20÷0.35	1800	0.40÷0.60

Difference in clamping and overhang portion

LONG

HAND TAPS

EG (STI)

DOUBLE-ENDED TYPE

Smaller flexibility in the overhang portion
Minimum clamping portion

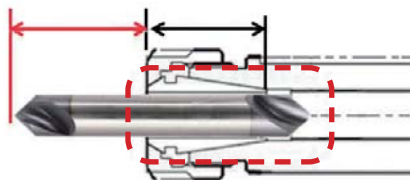

SINGLE-ENDED TYPE

The extended shank gives more overhang flexibility
Minimum clamping portion

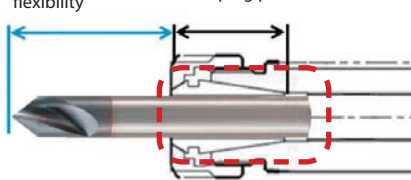

SPECIAL THREADS, GAUGES

THREAD MILLS

DIES

Process data

Size	Ø12x90°
Workpiece material	42CrMo4 - 1.7225
Part for process	15° slant surface
Drilling speed	25m/min
Feed	0.15mm/rev
Lubricant	Water soluble oil (x20)
Machine	Machining center

Positioning accuracy on 15° slant surface

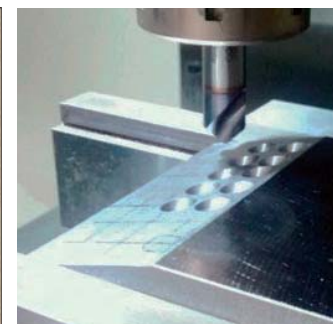
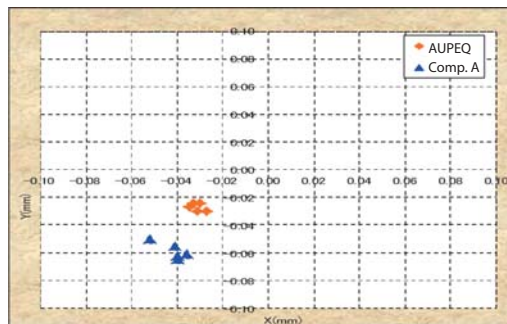

CENTER DRILLS
YMW

Technical info

Application

• HOLE CENTERING OR CHAMFERING

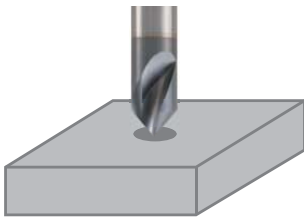

• CORNER CHAMFERING

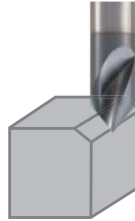

• V SLOTTING

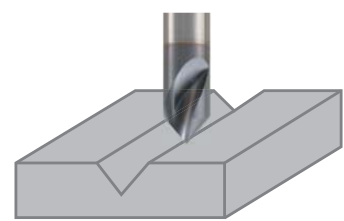

Production process

Point drilling

Hole centering and chamfering performed at the same time

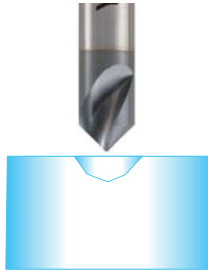

Drilling



Tapping



TYPE: AUPEQ_01

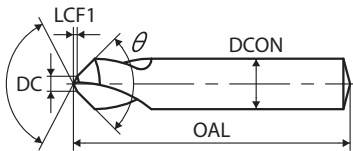

DC x θ x DCON	Code	DC (mm)	DCON (mm)	OAL (mm)	LCF (mm)	Type	Stock
YMW							
3.0 x 0.5 x 90°	PZ93.00ZNETZ	0.5	3	35	0.13	01	●
4.0 x 1.0 x 90°	PZ94.00ZNETZ	1	4	35	0.26	01	●
6.0 x 2.0 x 90°	PZ96.00ZNETZ	2	6	45	0.52	01	●
8.0 x 2.5 x 90°	PZ98.00ZNETZ	2.5	8	50	0.65	01	●
10.0 x 3.0 x 90°	PZ910.0ZNETZ	3	10	55	0.78	01	●
12.0 x 3.5 x 90°	PZ912.0ZNETZ	3.5	12	65	0.91	01	●
16.0 x 4.0 x 90°	PZ916.0ZNETZ	4	16	70	1.04	01	●
20.0 x 5.0 x 90°	PZ920.0ZNETZ	5	20	80	1.30	01	●

Intro

SP

SL

PO

ST

ROLL

CARBIDE

LONG

HAND TAPS

EG (STI)

SPECIAL THREADS, GAUGES

THREAD MILLS

DIES

CENTER DRILLS
YMW

Technical info

Intro

AUPES



SP

Single-ended Point Drills PE-60°, Coated

SL



FEATURES

For positioning, chamfering hole, chamfering outer edge and V slotting.

HSS and special coating for high speed machining and excellent surface finishing.

PO

ST

ROLL

CARBIDE

	P1		P2		P3		P4		M1 M2 P7		N1 N2	
Workpiece Material	Soft Steels St.44-2 - 1.0044		Carbon steels Ck50 - 1.1206		Alloy steels 42CrMo4 - 1.7225		Thermal refined steels		Stainless steels AISI304 - 1.4301 - X5CrNi18-9		Aluminium alloy castings G-AISi8Cu3 - A380	
Vc (m/min)	38÷48		28÷38		26÷33		13÷17		13÷20		84÷120	
Diameter (mm)	RPM	Feed (mm/rev)	RPM	Feed (mm/rev)	RPM	Feed (mm/rev)	RPM	Feed (mm/rev)	RPM	Feed (mm/rev)	RPM	Feed (mm/rev)
3	4550	0.04÷0.08	3500	0.04÷0.08	3150	0.04÷0.08	1800	0.03÷0.06	1750	0.04÷0.08	10800	0.10÷0.22
4	3400	0.05÷0.10	2650	0.05÷0.10	2350	0.05÷0.10	1200	0.04÷0.08	1300	0.05÷0.10	8100	0.12÷0.26
6	2300	0.06÷0.12	1750	0.06÷0.12	1550	0.06÷0.12	800	0.05÷0.10	900	0.06÷0.12	5400	0.15÷0.30
8	1700	0.08÷0.15	1300	0.08÷0.15	1150	0.08÷0.15	600	0.06÷0.12	650	0.08÷0.15	4050	0.18÷0.35
10	1350	0.10÷0.18	1050	0.10÷0.18	950	0.10÷0.18	500	0.08÷0.15	500	0.10÷0.18	3250	0.21÷0.40
12	1150	0.12÷0.22	900	0.12÷0.22	800	0.12÷0.22	400	0.10÷0.18	450	0.12÷0.22	2700	0.25÷0.45
16	850	0.16÷0.26	650	0.16÷0.26	600	0.16÷0.26	300	0.12÷0.22	350	0.16÷0.26	2050	0.32÷0.50
20	700	0.20÷0.35	500	0.20÷0.35	450	0.20÷0.35	250	0.16÷0.26	250	0.20÷0.35	1800	0.40÷0.60

Difference in clamping and overhang portion

LONG

HAND TAPS

EG (STI)

DOUBLE-ENDED TYPE

Smaller flexibility in the overhang portion
Minimum clamping portion

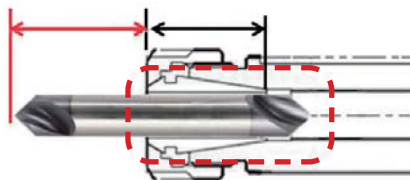

SINGLE-ENDED TYPE

The extended shank gives more overhang flexibility
Minimum clamping portion

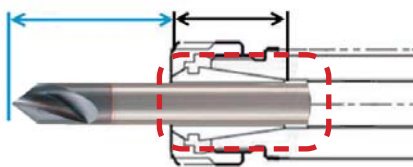

SPECIAL THREADS, GAUGES

THREAD MILLS

DIES

Process data

Size	Ø12x90°
Workpiece material	42CrMo4 - 1.7225
Part for process	15° slant surface
Drilling speed	25m/min
Feed	0.15mm/rev
Lubricant	Water soluble oil (x20)
Machine	Machining center

Positioning accuracy on 15° slant surface

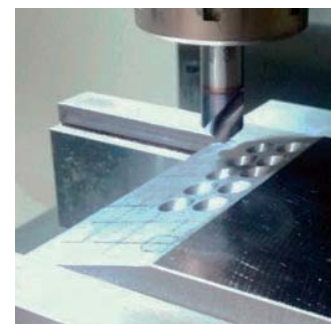
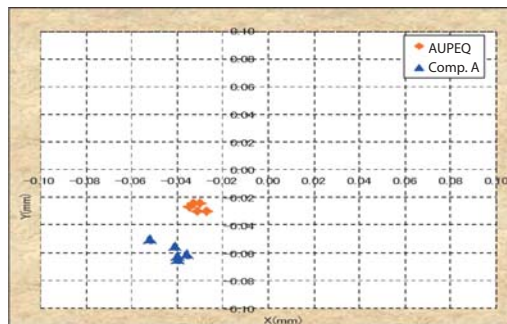

CENTER DRILLS
YMW

Technical
info

Application

• HOLE CENTERING OR CHAMFERING

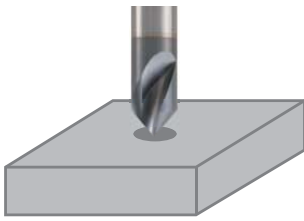

• CORNER CHAMFERING

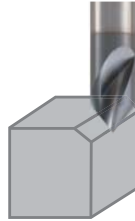

• V SLOTTING

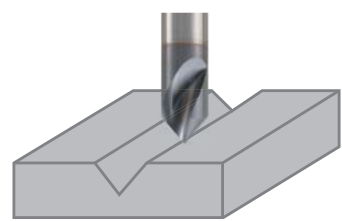

Production process

Point drilling

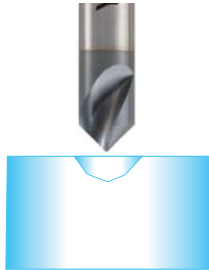

Hole centering and chamfering performed at the same time

Drilling



Tapping



TYPE: AUPES_01

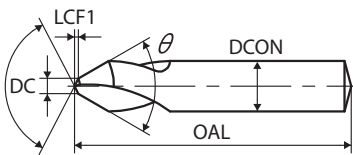

DC x θ x DCON	Code	DC (mm)	DCON (mm)	OAL (mm)	LCF (mm)	Type	Stock
YMW							
3.0 x 0.5 x 60°	PZ63.00ZNETZ	0.5	3	35	0.13	01	●
4.0 x 1.0 x 60°	PZ64.00ZNETZ	1	4	35	0.26	01	●
6.0 x 2.0 x 60°	PZ66.00ZNETZ	2	6	45	0.52	01	●
8.0 x 2.5 x 60°	PZ68.00ZNETZ	2.5	8	50	0.65	01	●
10.0 x 3.0 x 60°	PZ610.0ZNETZ	3	10	55	0.78	01	●
12.0 x 3.5 x 60°	PZ612.0ZNETZ	3.5	12	65	0.91	01	●
16.0 x 4.0 x 60°	PZ616.0ZNETZ	4	16	70	1.04	01	●
20.0 x 5.0 x 60°	PZ620.0ZNETZ	5	20	80	1.30	01	●

Intro

SP

SL

PO

ST

ROLL

CARBIDE

LONG

HAND TAPS

EG (STI)

SPECIAL THREADS, GAUGES

THREAD MILLS

DIES

CENTER DRILLS
YMW

Technical info

TECHNICAL INFO

Index

1. Terminology of Taps	626
2. ISO 13399	627
3. Flutes	628
4. Cutting edge and thread relief	629
5. Tapping Torque	630
6. Recommended Tapping Speed	633
7. Tapping speed and Revolutions	634
8. Internal Thread Tolerance and Classes of Taps	635
9. Comparison of pitch diameter tolerance	636
10. Tap Thread Limits (JIS, DIN, ANSI)	652
11. Differences between UN and UNJ threads	672
12. Recommended drill sizes for tapping internal UN and UNJ threads	673
13. Introduction to Thread Forming Taps (Roll Taps)	674
14. Materials used for Cutting Tools	676
15. Surface Treatment	678
16. Carbide Taps	681
17. Taps for Pipe Threads	683
18. Selecting different tap holder combinations by machine feed system	690
19. The mechanism for a tap to cut oversize on an internal thread	692
20. Troubleshooting	694
21. Thread Series	698
22. Basic Profile of Threads	700
23. Symbols for Standard Threads	703
24. Drill size and recommended hole size for cutting taps	706
25. Drill size and recommended hole size for forming taps	718
26. Bar diameter for cutting dies	720
27. Lineup arranged by size	724
28. ISO 513 work materials	738

1. Terminology of Taps

Intro

SP

SL

PO

ST

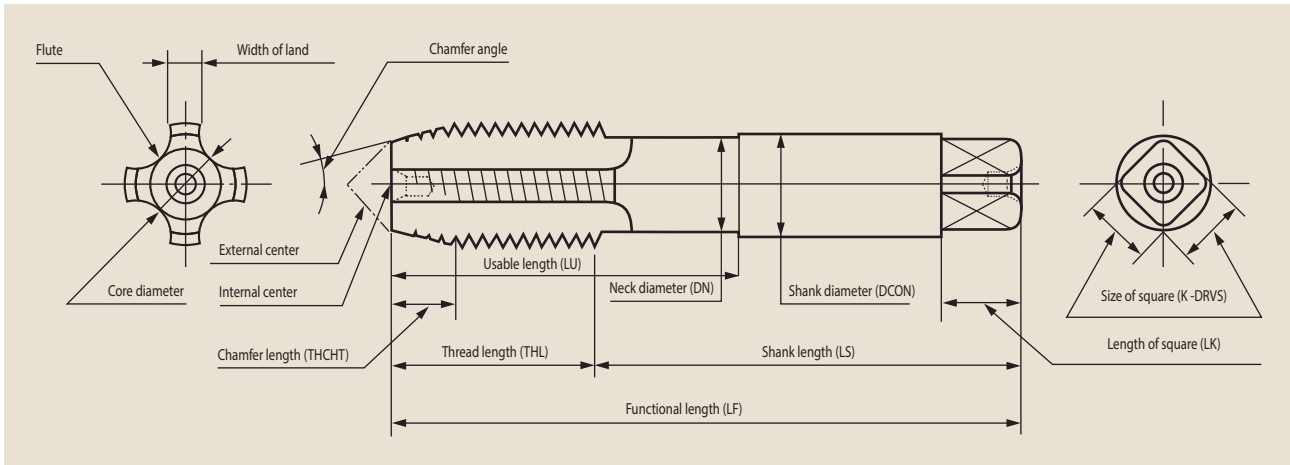

Chamfer relief

Threads relief and cutting angle

ROLL

CARBIDE

LONG

HAND TAPS

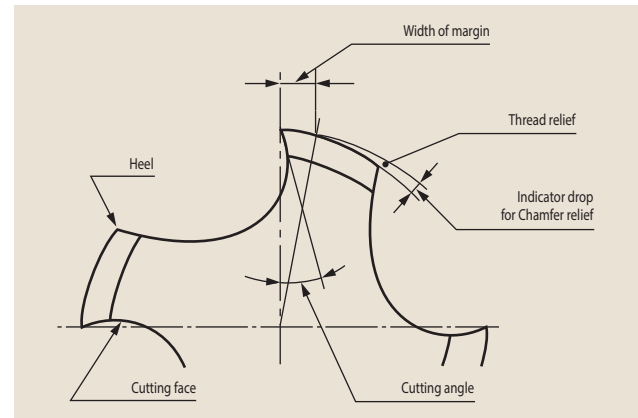
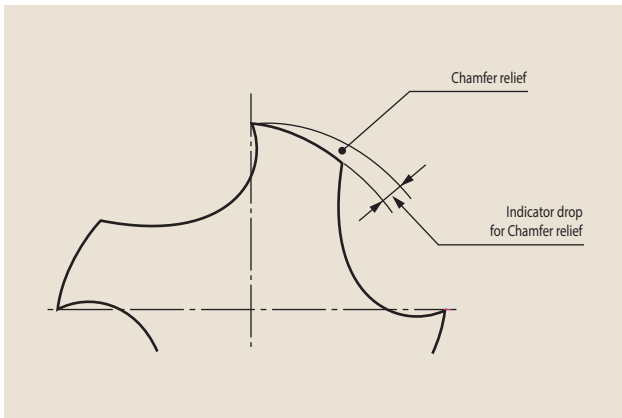

Edge angle, including chamfer relief, thread relief, cutting angle and others, as well as heat treatment, have important functions affecting workpiece shape, tool life, surface finish of internal screw thread, and so on.

EG (STI)

Chamfer of straight fluted taps

SPECIAL THREADS, GAUGES

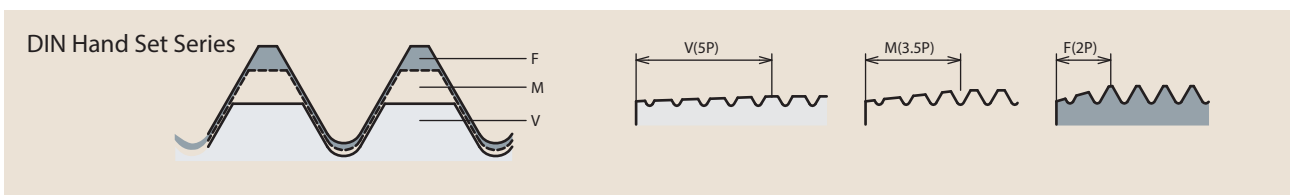

THREAD MILLS

Serial taps come in sets of three (DIN352, DIN351) or two (DIN2181, DIN5157) to complete screw threads by cutting work materials in incremental steps. The first tap (V) and the second tap (M) cut screw threads under size. Then, the third tap (F) completes the screw threads.

DIES

CENTER DRILLS

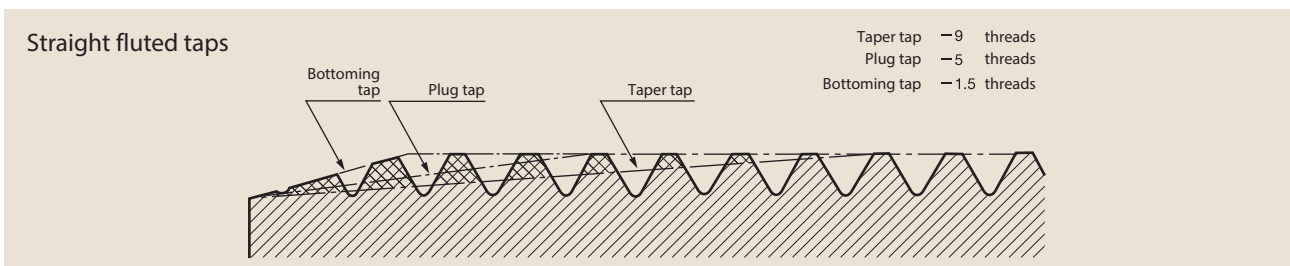

Technical info

In general, tap chamfer is the most important part of taps to create internal thread. The function of full thread part of taps is to make a guidance.

2. ISO 13399

Intro

APMX	Maximum depth of cut
BSG	Basic standard group
DC	Cutting diameter
DCON	Connection diameter
DN	Neck diameter
FHA	Flute helix angle
LF	Functional length
LK	Square length
LS	Shank length
LT	Chamfer+full thread length
LU	Usable length
K (DRVS)	Drive (square) size
NOF	Number of flutes
TCDCON	Connection diameter tolerance
TCTR	Thread tolerance class
TDZ	Thread size
THCHT	Type of chamfer
THL	Thread length
TP	Thread pitch
TPI	Thread per inch
ZEFP	Peripheral effective cutting edge count

SP

SL

PO

ST

ROLL

CARBIDE

ISO 13399 denomination for taps

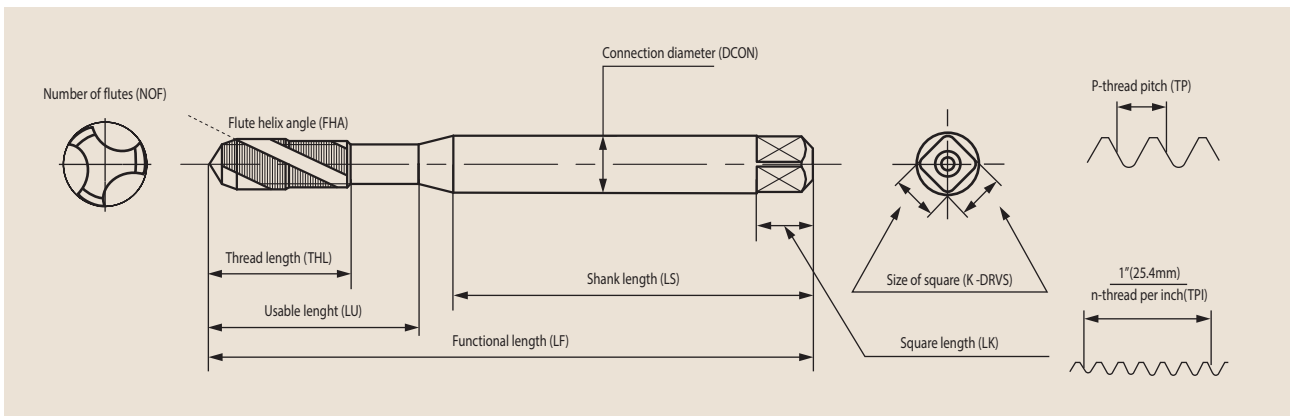

LONG

HAND TAPS

EG (STI)

SPECIAL THREADS, GAUGES

ISO 13399 denomination for thread mills

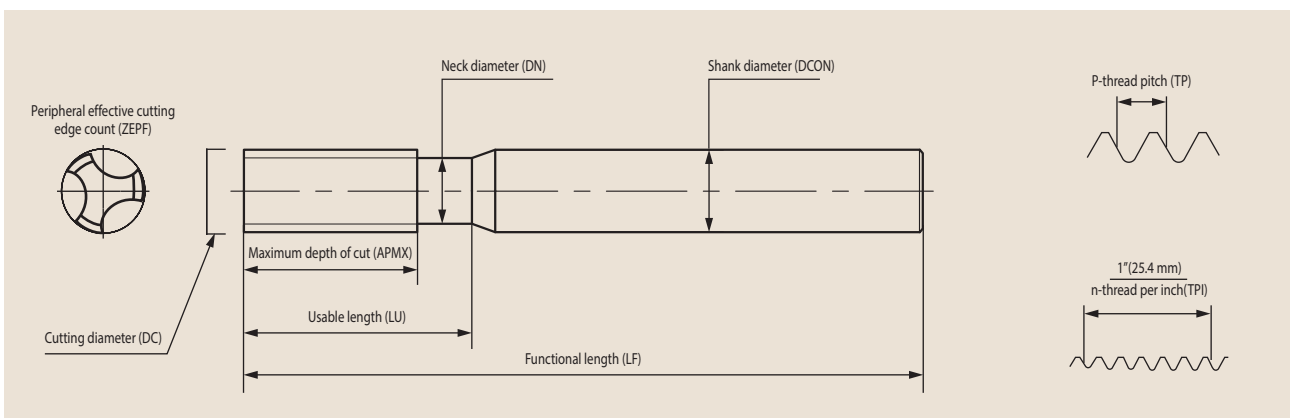

THREAD MILLS

DIES

CENTER DRILLS

Technical info

3. Flutes

Intro

Major functions of flutes are

1) Chips' pocket, 2) lubricant supply route, 3) rake angle formation, 4) to determine cutting amount in relation to the number of chamfer threads. All are very important. Taps' flutes are classified into following groups by tapping methods, fluting method, tapping direction, and hand of screw thread.

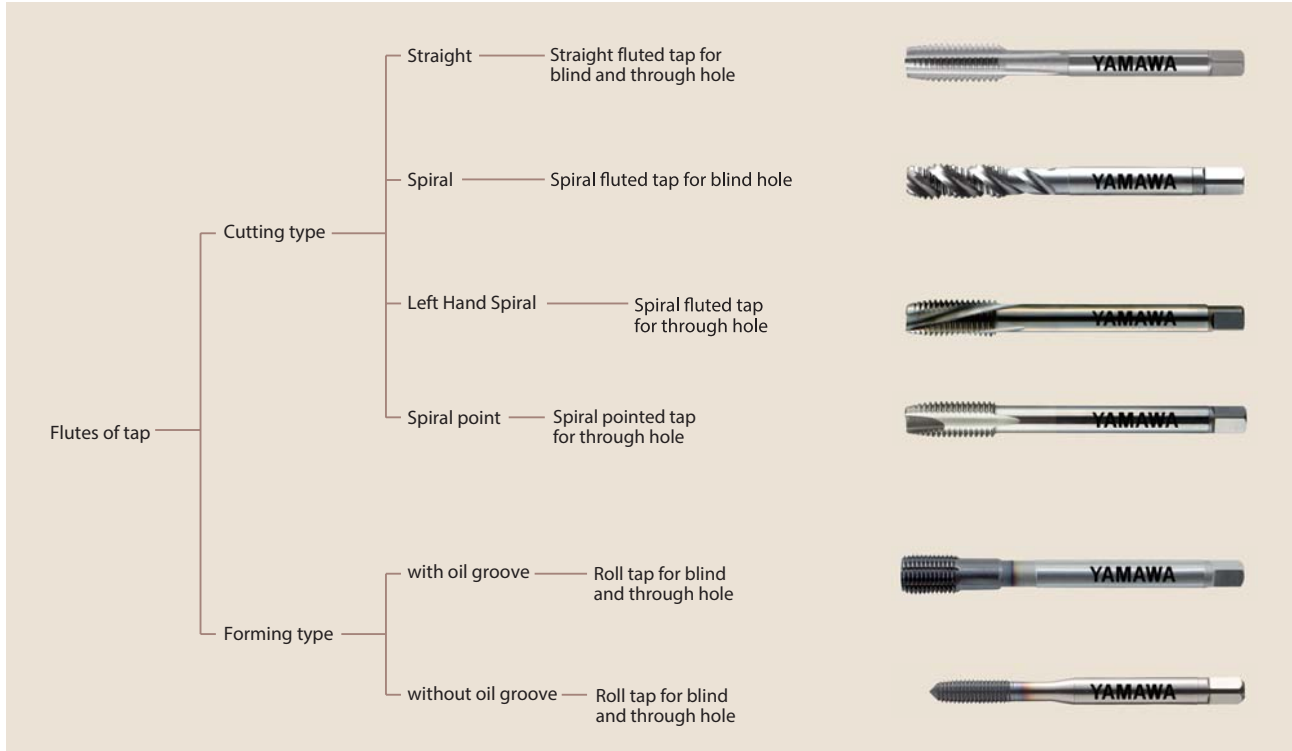

SL

PO

ST

ROLL

CARBIDE

LONG

HAND TAPS

Type of Flute

Type of tap	Cutting type		Type of tap	Forming type
Flute			Flute	
Straight Flute			With oil groove	
Spiral Flute			Without oil groove	
Spiral Point Flute				

EG (STI)

SPECIAL THREADS, GAUGES

THREAD MILLS

DIES

CENTER DRILLS

In general, the number of flutes for cutting taps usually increases as the diameter becomes larger. However, it is also influenced by tap's strength and rigidity, the accommodation of chip, the amount of cutting, and lubricant supply system.

Technical info

4. Cutting angle and thread relief

Cutting angle and Chamfer relief angle

θ : Cutting angle γ : Chamfer relief angle

Chordal Hook Angle	Rake Angle	Tangential Hook Angle
<p>Cutting angle of hook face. The angle between the center line passing the cutting edge and the straight line linking the cutting edge with the thread root.</p>	<p>Cutting angle of rake face. The angle between the center line passing the cutting edge and the straight line linking the cutting edge with thread root.</p>	<p>Cutting angle of hook face. The angle between the center line passing the cutting edge and the straight line tangent to the rake face on the cutting edge.</p>

Thread relief

S: Indicator drop for thread relief

Concentric-unrelieved	Con-eccentric thread relief	Eccentric thread relief
<p>No relief exists at land. Start (A) and heel (B) of thread land have same concentricity.</p>	<p>Radial relief in the thread form starts at the back of a concentric margin.</p>	<p>Radial relief in the thread form starts at the cutting edge and continues to the heel.</p>

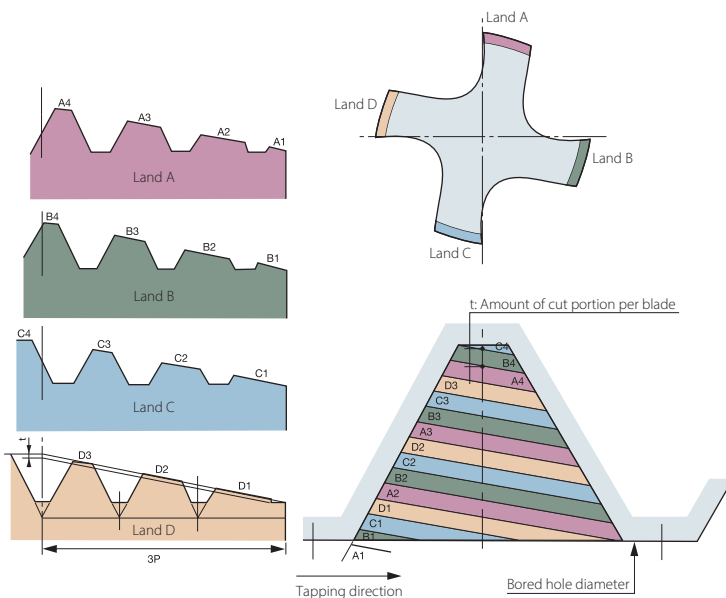

The amount of cut portion

Please refer to the pictures shown. For the taps with 4 flutes and 3 threads chamfer, the cutting operation progresses in order from the edge of A1, B1, C1, D1... A2, B2...A4. Tap end is usually smaller than the size of bored hole, and A1 may not make any cutting operation.

Intro
SP
SL
PO
ST
ROLL
CARBIDE
LONG
HAND TAPS
EG (STI)
SPECIAL THREADS, GAUGES
THREAD MILLS
DIES
CENTER DRILLS
Technical info

5. Tapping Torque

Intro

SP

Tapping Torque of Cutting Taps

The torque starts increasing as the threads of the chamfer enter the workpiece material. It reaches the highest level when all the threads of the chamfer cut into workpiece material, and is in plateau until the chamfer cuts through the workpiece. After that, the torque decreases until the end of tapping.

SL

Tapping Torque Equation for Cutting Taps

$$T_c = \frac{\tan\theta}{24000} \cdot k_c \times K(D-D_o)^2 \times (D+2D_o)$$

T_c : Tapping Torque (Nm)
k_c : Specific cutting resistance (N/mm²)
K : Correction coefficient depending on tap geometry and chips
D : Nominal Diameter of Tap (mm)
D_o : Bored hole diameter (mm)
θ : Thread half angle (°)

k_c and K : Refer to Table 1 and Table 2

PO

ST

ROLL

CARBIDE

Table 1 Specific cutting resistance of each material

Materials to be cut		Specific cutting resistance k _c N/mm ²
Material symbols	Hardness	N/mm ²
5t44-2	133HB	3700
Ck 15	141HB	3600
Ck 35	162HB	3700
Ck 45	188HB	3900
Ck 60	188HB	4000
42 CrMo 4	193HB	3600
	30HRC	4900
	40HRC	5500
X 6 CrNi 18 10	209HB	4200
C 105 W2	175HB	5300
CnZn40	-	2300
G-AlSi8Cu3	-	1300
GG-25	193HB	2900

Table 2 Correction coefficient depending on each tap geometry

Materials to be cut	Coefficient K					
	Steel		Cast iron + Aluminium alloys		Brass	
Kinds of tap	coarse	fine	coarse	fine	coarse	fine
Straight fluted tap 5P	1.35	1.15	1.25	1.08	1.60	1.12
Straight fluted tap 1.5P	1.43	1.50	1.30	1.25	1.68	-
Spiral fluted tap	1.15	1.25	1.05	1.10	0.85	-
Spiral pointed tap	0.95	1.00	0.80	1.00	0.75	1.00

LONG

HAND TAPS

EG (STI)

SPECIAL THREADS, GAUGES

THREAD MILLS

DIES

CENTER DRILLS

Technical info

Cutting Torque Line

Cutting torque line for different kinds of taps (straight fluted tap, spiral fluted tap, spiral pointed tap) is shown below.

Tap	: HSS ISO2(6H) M8×1.25	Bored hole size	: 6.8 mm
Cutting speed	: 6 m/min	Cutting oil	: Oil
Workpiece material	: Ck60	Machine	: Drilling machine
Tapping type	: 10 mm Through hole	Measurement equipment	: Piezoelectric torque tester

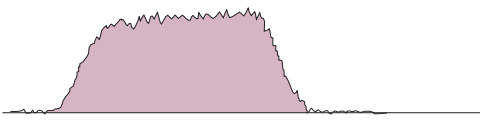
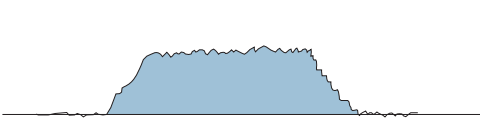
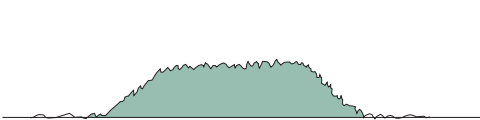
Type of tap	Torque line	Description
Straight fluted tap	5P 	Plateau is observed since whole chamfer threads enter the workpiece material.
	1.5P (1.5 threads) 	Plateau is also observed since whole short chamfer threads enter the workpiece material. Tapping process time is shorter than that of the 5P tap.
Spiral fluted tap (2.5 threads)		Spiral fluted tap pulls out the chips, good choice for blind hole tapping. The cutting torque of spiral fluted taps is lower than that of the hand taps.
Spiral pointed tap (5 threads)		Spiral pointed tap pushes out the chips forward. It is good choice for through hole use. Cutting torque is the smallest among the different tap shapes.

The cutting torque changes depending on the kind of taps, cutting chamfer, number of flutes, workpiece materials and their hardness, lubrication types, and chips.

Comparison of Cutting Torque by Different Type of Taps

Cutting torque of straight fluted tap (HT), and spiral fluted tap (SP), and spiral pointed tap (PO) differs, shown in the chart below.

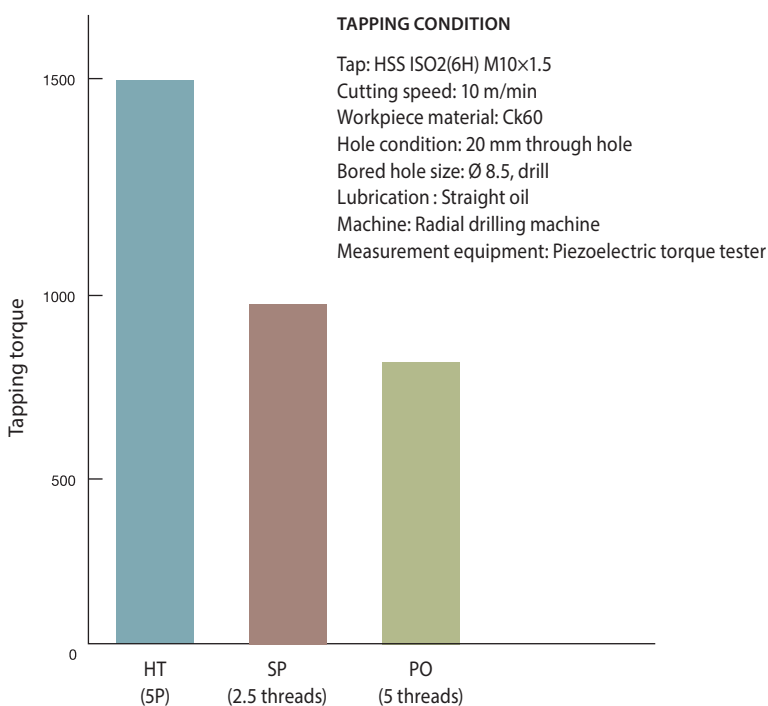

If the cutting torque of straight fluted tap is assumed as 100, the cutting torque of other taps is as follows :

Straight fluted Tap	: 100
Spiral fluted Tap	: 70-75
Spiral Pointed Tap	: 60-65

- SP
- SL
- PO
- ST
- ROLL
- CARBIDE
- LONG
- HAND TAPS
- EG (STI)
- SPECIAL THREADS, GAUGES
- THREAD MILLS
- DIES
- CENTER DRILLS

5. Tapping Torque

Intro

Calculation for Tapping Torque of Roll Taps

SP

It is hard to calculate the tapping torque for roll taps because they contain more complicated factor than the cutting taps.

According to our experience, the tapping torque of roll taps is twice or three times larger than that of the cutting taps in general.

SL

Major factors increasing or decreasing the tapping torque of roll taps are :

- (1) Mechanical characteristic of workpiece (Tensile strength, hardness, spring back feature, work hardening index). As the tensile strength gets larger, the threading torque becomes larger.
- (2) Size and length of bored hole: bored hole size is usually defined to obtain 75% thread height of basic thread profile (thread engagement). Roll taps may be shuttered due to the excessive tapping torque when the bored hole size is made smaller to obtain higher thread height. Tapping torque gets larger as the efficient length of internal screw becomes longer because there is an increase in friction coefficient caused by spring back of workpiece material.
- (3) Tapping process (tapping speed, lubricant, and rigidity of main spindle).
- (4) Surface treatment of taps (oxidizing, nitriding, TiN, and TiCN coatings).

PO

ST

Tapping Torque Equation for Forming Taps

The following equation provides an estimation of the tapping torque for standard forming taps, based on the tensile strength of the workpiece material.

ROLL

Condition : Effective length of internal screw is 1.5D. Thread height is 75%.

Tapping Torque Equation for Forming Taps

$$T = K_f \times D_c \times P^2 / 1000$$

T : Tapping Torque (Nm)
D_c : Nominal Diameter of Tap (mm)
P : Pitch (mm)
K_f : Deforming resistance (N/mm²)

CARBIDE

LONG

HAND
TAPS

EG (STI)

SPECIAL
THREADS,
GAUGES

THREAD
MILLS

DIES

CENTER
DRILLS

Workpiece Materials	Deforming resistance
	N/mm ²
General Structure Steels, Low Carbon Steels	750-850
Medium Carbon Steels, Alloy Steels	1150-1350
Stainless Steels	1100-1300
Wrought Aluminum	250-350
Aluminum Die Castings	380-530
Coppers, Wrought Copper Alloys	750-1050

Technical
info

6. Recommended Tapping Speed

Tapping Speed

The following machining conditions affect tapping speed: kind of taps, workpieces, number of chamfered threads, materials, hole condition and lubricant. It is necessary to select the suitable tapping speed by paying attention to these conditions. When work material has excellent workability, when there is a little depth of tapping, or when tapping lubricant can be sufficient, select rather higher tapping speed. When workability of work material is unknown, to be safe, try nearly the lowest tapping speed at first, and then increase the speed gradually. Following speed is basically for the cutting condition under the use of cutting oil. In case of water soluble cutting oil, please reduce the speed by 30%.

Workpiece Materials		Tapping Speed - Vc(m/min)				
		Spiral Fluted	Spiral Pointed	Roll Taps	Straight Fluted	Cemented Carbide
Low Carbon Steels	St44, C10~C25	8~15	10~20	8~15	6~10	-
Medium Carbon Steels	C25~C45	6~12	8~14	7~12	5~9	-
High Carbon Steels	C45~C58	5~10	8~12	5~10	5~8	-
Alloy Steels	CrMo~NiCrMo	5~10	7~10	5~10	5~8	-
Thermal refined steels	20~45HRC	3~5	4~7	-	3~6	-
Stainless Steels	AISI	3~8	4~9	6~15	3~7	-
Tool Steels	1.2311, 1.2344	5~8	6~10	-	5~9	-
Cast Steels	SC	6~10	8~13	-	6~10	-
Cast Irons	GG	-	-	-	12~17	15~25
Ductile Cast Irons	GGG	5~10	5~10	-	5~8	12~20
Coppers	Cu	8~12	8~13	25~35	7~11	15~33
Brass · Brass Casting	Bs · BsC	11~22	13~25	25~35	10~20	23~33
Phosphor Bronze · Phosphor Bronze Casting	PB · PBC	8~15	10~18	25~35	8~15	18~33
Wrought Aluminum	Al	15~25	20~25	25~35	15~20	23~40
Aluminum Alloy Castings	AlSi	11~22	12~24	15~25	10~20	15~25
Magnesium Alloy Castings	MC	7~15	10~20	-	7~15	12~20
Zinc Alloy Diecastings	ZDC	7~15	10~20	15~25	7~15	12~20
Thermosetting Plastic	Bakelite (phenol-PF)	11~17	12~18	-	10~15	15~25
Thermoplastic resin	PVC, Nylon	11~17	12~18	-	10~15	15~25
Titanium Alloys	Ti-6Al-AV etc	6~9	6~8	-	-	-
Nickel Base Alloys	Hastelloy, Inconel, Waspaloy	3~6	3~6	-	-	-

Formula

Tapping Speed (Vc)

$$Vc = \frac{\pi \cdot Dc \cdot n}{1000} \text{ (m/min)}$$

n : Revolutions per minute (min⁻¹)

π : 3.14

Dc : Nominal diameter of tap (mm)

Revolution per minute (n)

$$n = \frac{1000 \cdot Vc}{\pi \cdot Dc} \text{ (min}^{-1}\text{)}$$

Vc : Tapping Speed (m/min)

Dc : Nominal diameter of tap (mm)

π : 3.14

Intro

SP

SL

PO

ST

ROLL

CARBIDE

LONG

HAND TAPS

EG (STI)

SPECIAL THREADS, GAUGES

THREAD MILLS

DIES

CENTER DRILLS

Technical info

7. Tapping speed and Revolutions

Intro

Conversion table

SP

SL

PO

ST

ROLL

CARBIDE

LONG

HAND
TAPS

EG (STI)

SPECIAL
THREADS,
GAUGES

THREAD
MILLS

DIES

CENTER
DRILLS

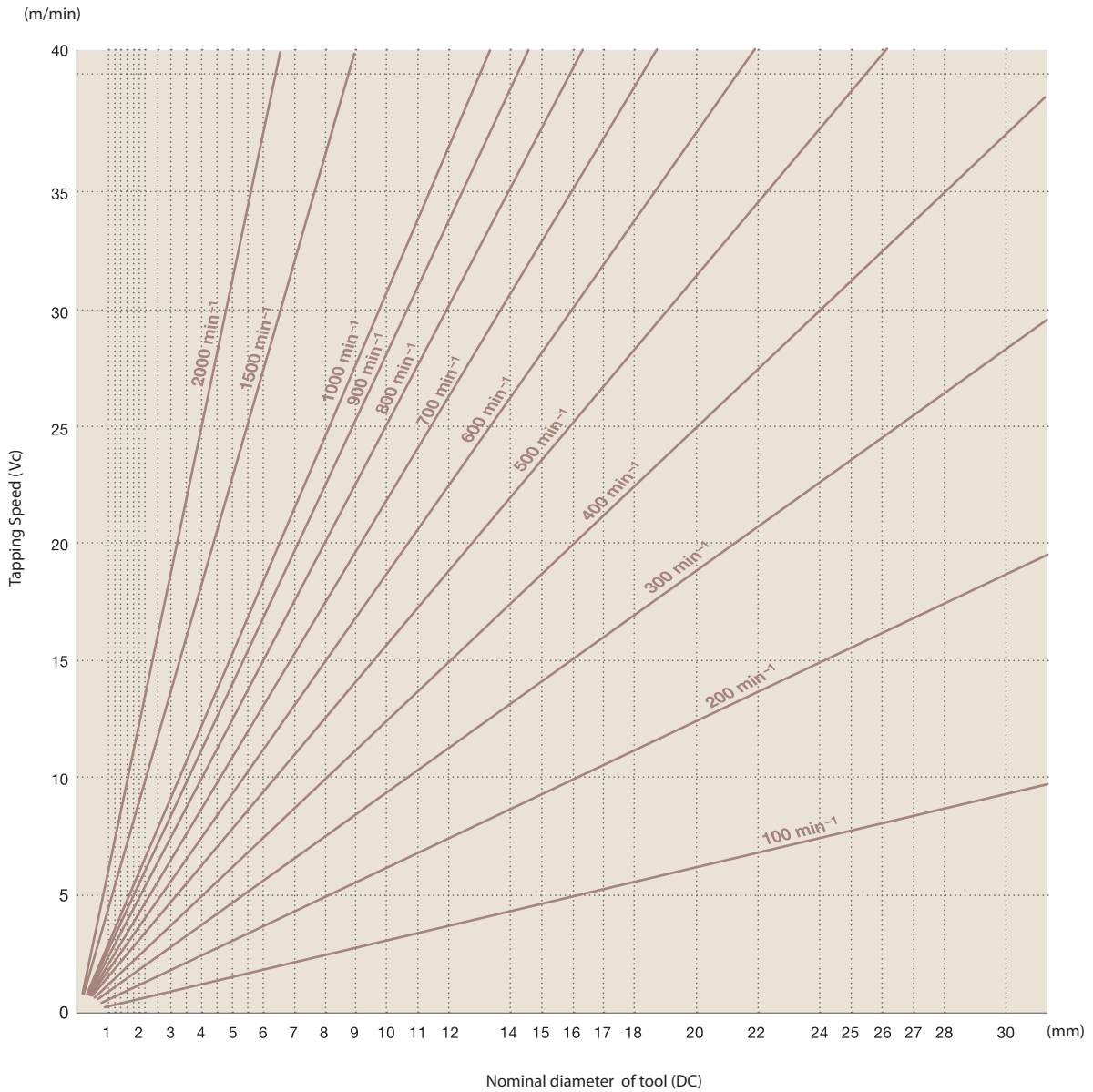

Technical
info

8. Internal Thread Tolerance and Classes of Taps

Intro

DIN EN 22857		DIN 802	Internal thread tolerance range				
Denomination	Characteristic						
Class 1	ISO 1	4H	4H	5H	-	-	-
Class 2	ISO 2	6H	4G	5G	6H	-	-
Class 3	ISO 3	6G	-	-	6G	7H	8H
-	-	7G	-	-	-	7G	8G

SP

SL

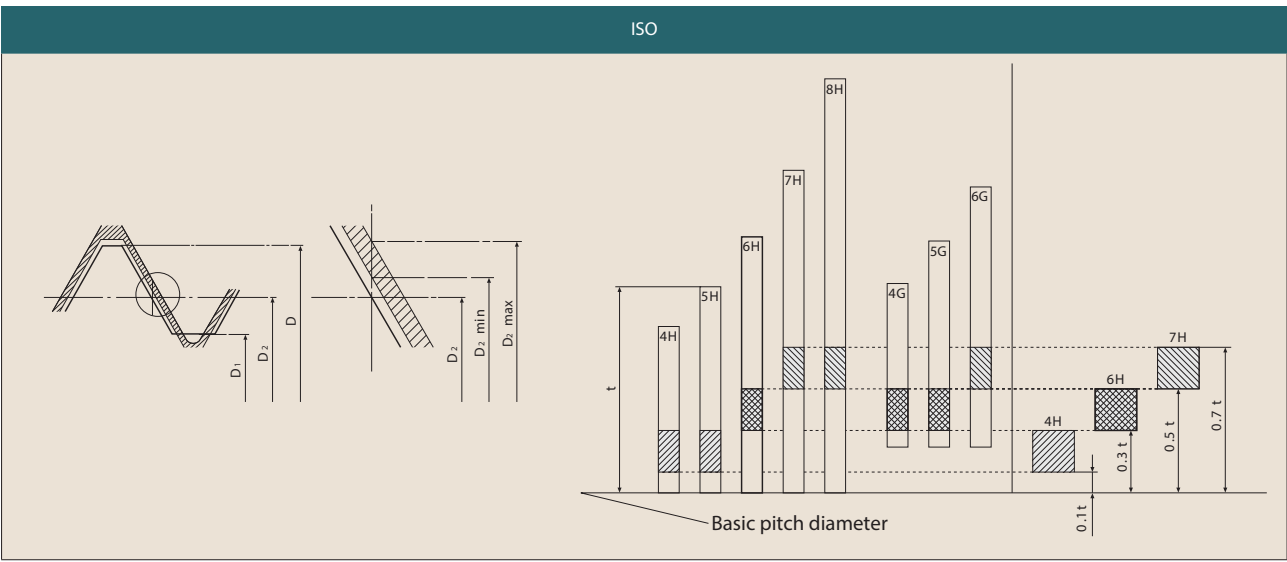

PO

ST

ROLL

CARBIDE

LONG

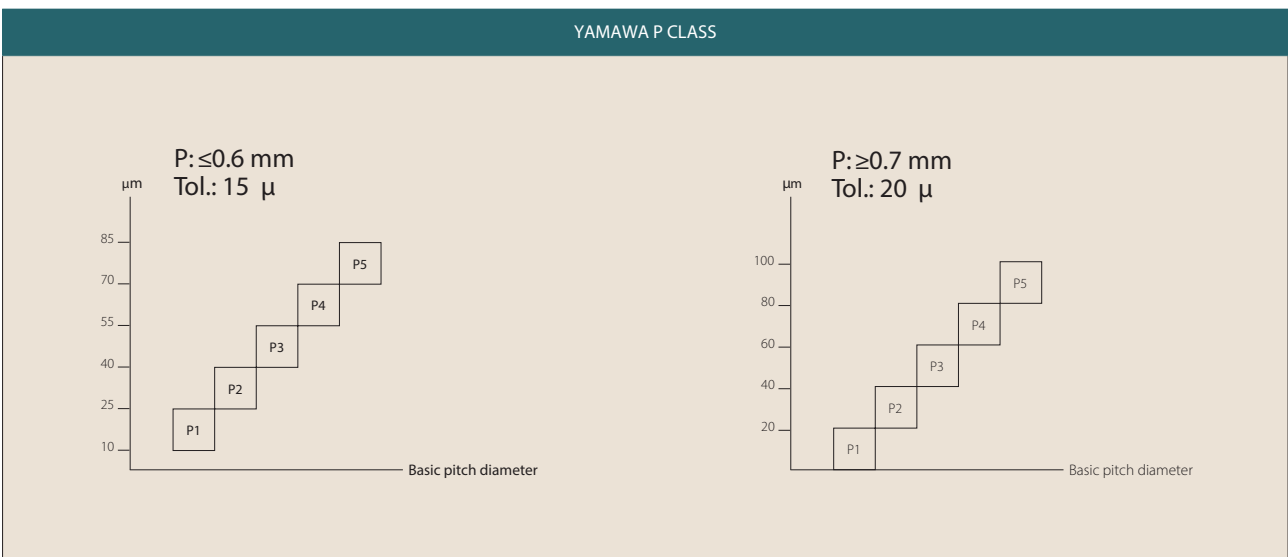

HAND TAPS

EG (STI)

SPECIAL THREADS, GAUGES

THREAD MILLS

DIES

CENTER DRILLS

ISO2X (6HX)	
ISO3X (6GX)	
$p = 0.2 \text{ mm} \sim 0.7 \text{ mm}$	$x = +15 \mu$
$p = 0.75 \text{ mm} \sim 1 \text{ mm}$	$x = +20 \mu$
$p = 1.25 \text{ mm} \sim 2.5 \text{ mm}$	$x = +25 \mu$
$p = 2.5 \text{ mm} \sim$	$x = +30 \mu$

Technical info

9. Comparison of pitch diameter tolerance

Intro

For Cutting Tap Metric Coarse Thread (M)

SP

Basic Pitch Dia.

(+) μm

0 | 20 | 40 | 60 | 80 | 100 | 120 | 140 | 160 | 180 | 200 | 220 | 240 | 260 | 280 | 300 | 320 | 340 | 360 | 380 | 400 | 420

SL

M1 × 0.25
M1.1 × 0.25
M1.2 × 0.25

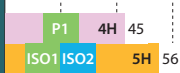

PO

M1.4 × 0.3

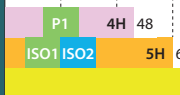

ST

M1.6 × 0.35
M1.7 × 0.35
M1.8 × 0.35

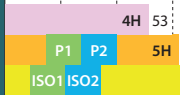

ROLL

M2 × 0.4
M2.3 × 0.4

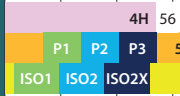

CARBIDE

M2.2 × 0.45
M2.5 × 0.45
M2.6 × 0.45

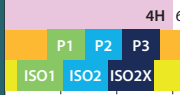

LONG

M3 × 0.5



HAND, TAPS

M3.5 × 0.6

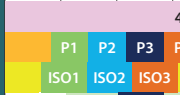

EG (STI)

M4 × 0.75
M4.5 × 0.75

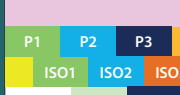

SPECIAL THREADS, GAUGES

M5 × 0.8



THREAD MILLS

M6 × 1
M7 × 1

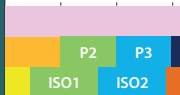

DIES

M8 × 1.25
M9 × 1.25

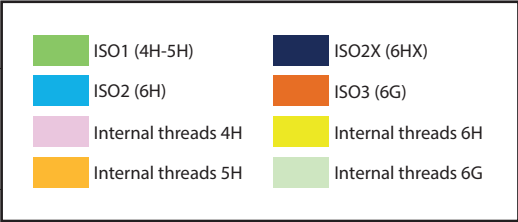
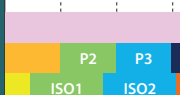

CENTER DRILLS

Technical info

For Cutting Tap Metric Coarse Thread (M)

Basic Pitch
Dia.

(+) μm

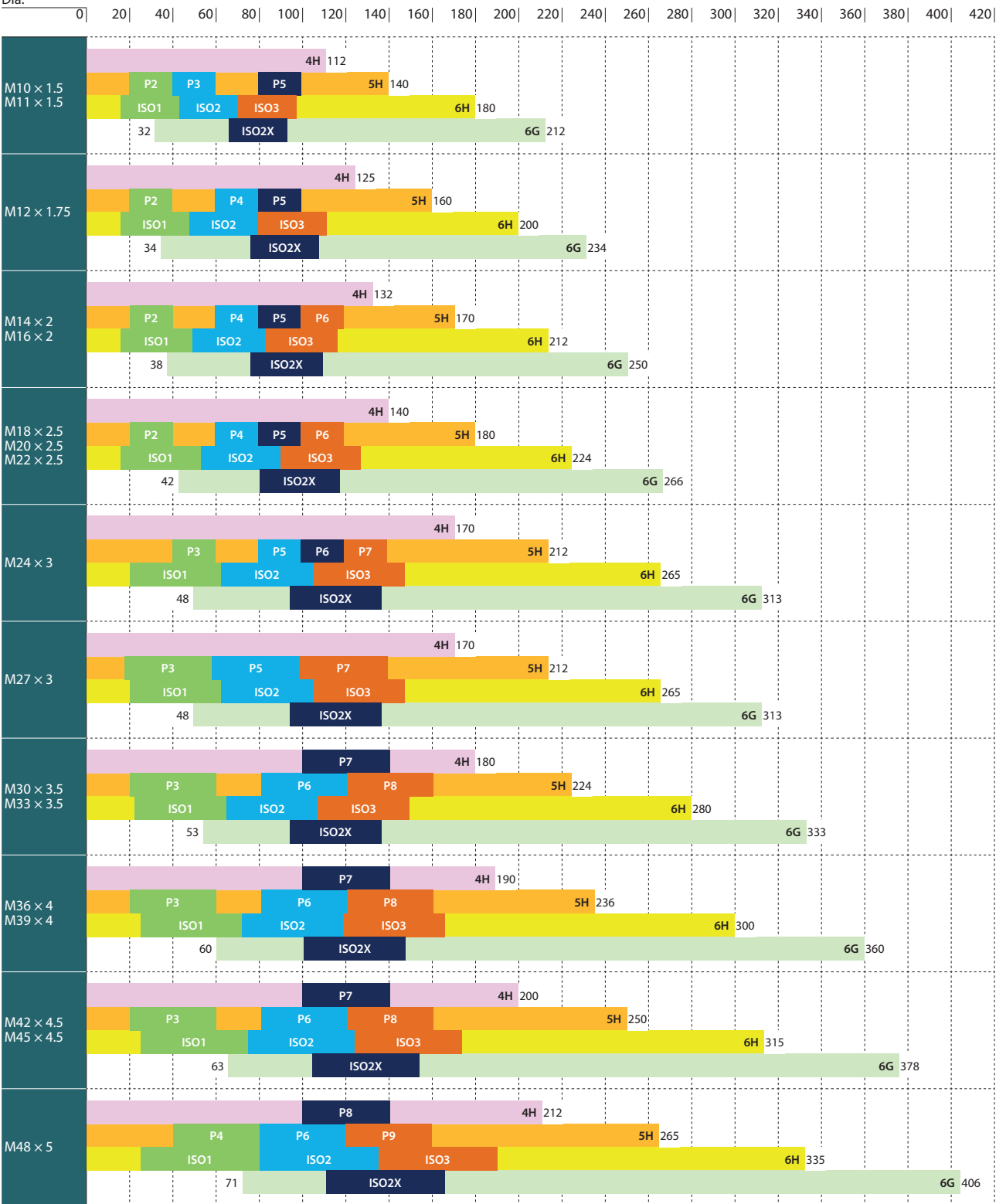

- SP
- SL
- PO
- ST
- ROLL
- CARBIDE
- LONG
- HAND TAPS
- EG (STI)
- SPECIAL THREADS, GAUGES
- THREAD MILLS
- DIES
- CENTER DRILLS

Technical info

9. Comparison of pitch diameter tolerance

Intro

For Cutting Tap Metric Fine Thread (MF)

SP

Basic Pitch
Dia.

(+) μm

0 | 20 | 40 | 60 | 80 | 100 | 120 | 140 | 160 | 180 | 200 | 220 | 240 | 260 | 280 | 300 | 320 | 340 | 360 | 380 | 400 | 420

SL

MF1 × 0.2
MF1.1 × 0.2
MF1.2 × 0.2
MF1.4 × 0.2

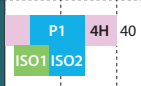

PO

MF1.6 × 0.2
MF1.7 × 0.2
MF1.8 × 0.2

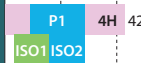

ST

MF2 × 0.25
MF2.2 × 0.25
MF2.3 × 0.25



ROLL

MF2.5 × 0.35
MF2.6 × 0.35

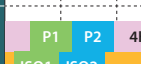

CARBIDE

MF3 × 0.35
MF3.5 × 0.35

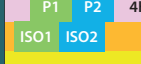

LONG

MF4 × 0.5
MF4.5 × 0.5
MF5 × 0.5
MF5.5 × 0.5



HAND, TAPS

MF6 × 0.5
MF7 × 0.5
MF8 × 0.5
MF9 × 0.5
MF10 × 0.5



EG (STI)

MF6 × 0.75
MF7 × 0.75
MF8 × 0.75
MF9 × 0.75
MF10 × 0.75
MF11 × 0.75

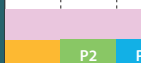

SPECIAL THREADS, GAUGES

MF8 × 1
MF9 × 1
MF10 × 1
MF11 × 1

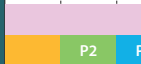

THREAD MILLS

MF10 × 1.25
MF11 × 1.25

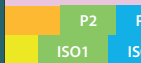

DIES

MF12 × 0.75

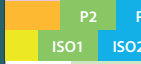

CENTER DRILLS

MF12 × 1
MF14 × 1
MF16 × 1
MF18 × 1
MF20 × 1
MF22 × 1

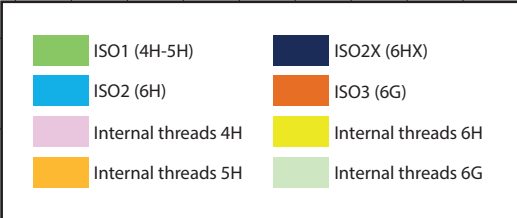
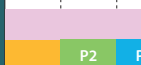

Technical info

For Cutting Tap Metric Fine Thread (MF)

Basic Pitch Dia. (+) μm

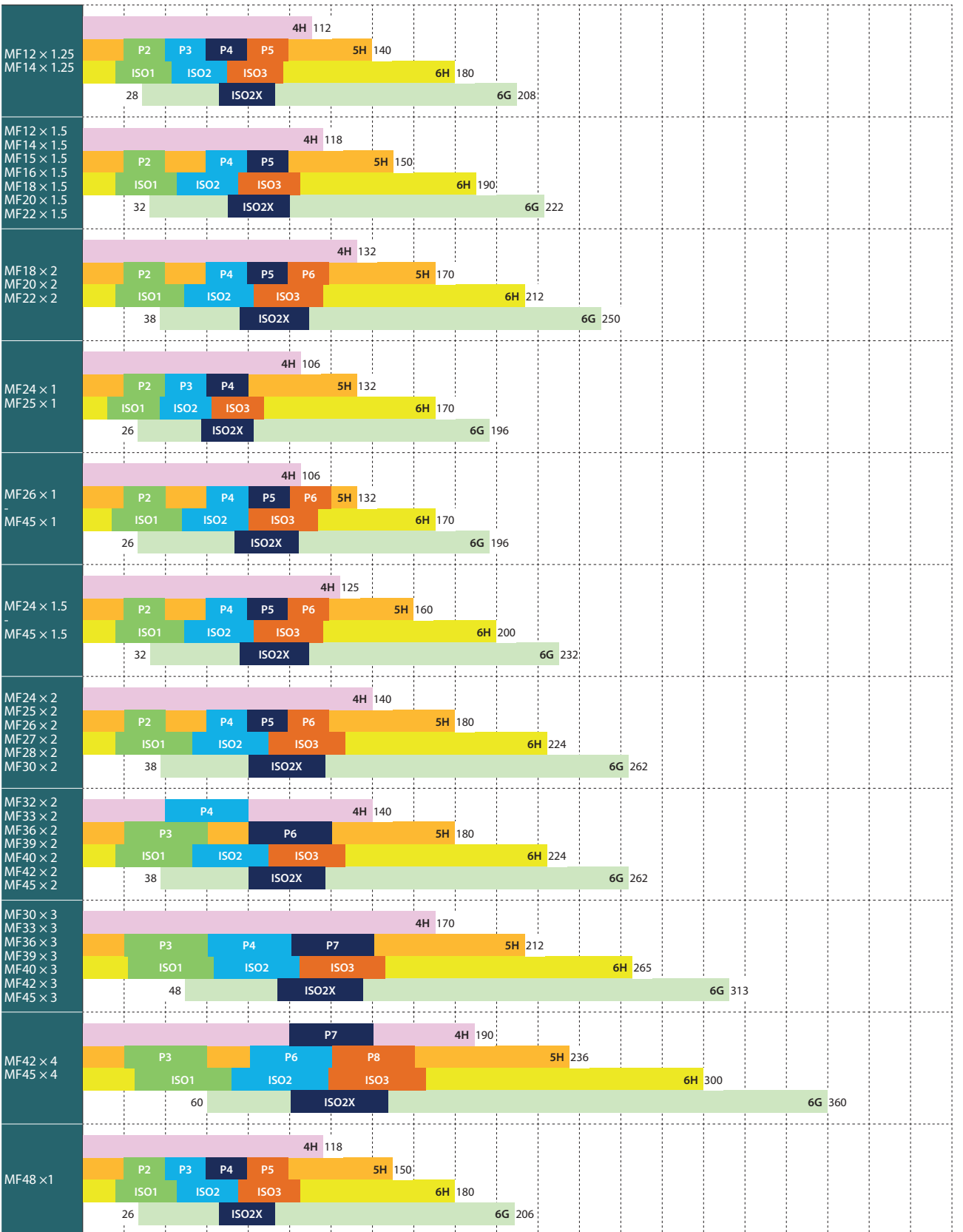

- SP
- SL
- PO
- ST
- ROLL
- CARBIDE
- LONG
- HAND TAPS
- EG (STI)
- SPECIAL THREADS, GAUGES
- THREAD MILLS
- DIES
- CENTER DRILLS

Technical info

9. Comparison of pitch diameter tolerance

Intro

For Cutting Tap Metric Fine Thread (MF)

SP

Basic Pitch
Dia.

(+) μm

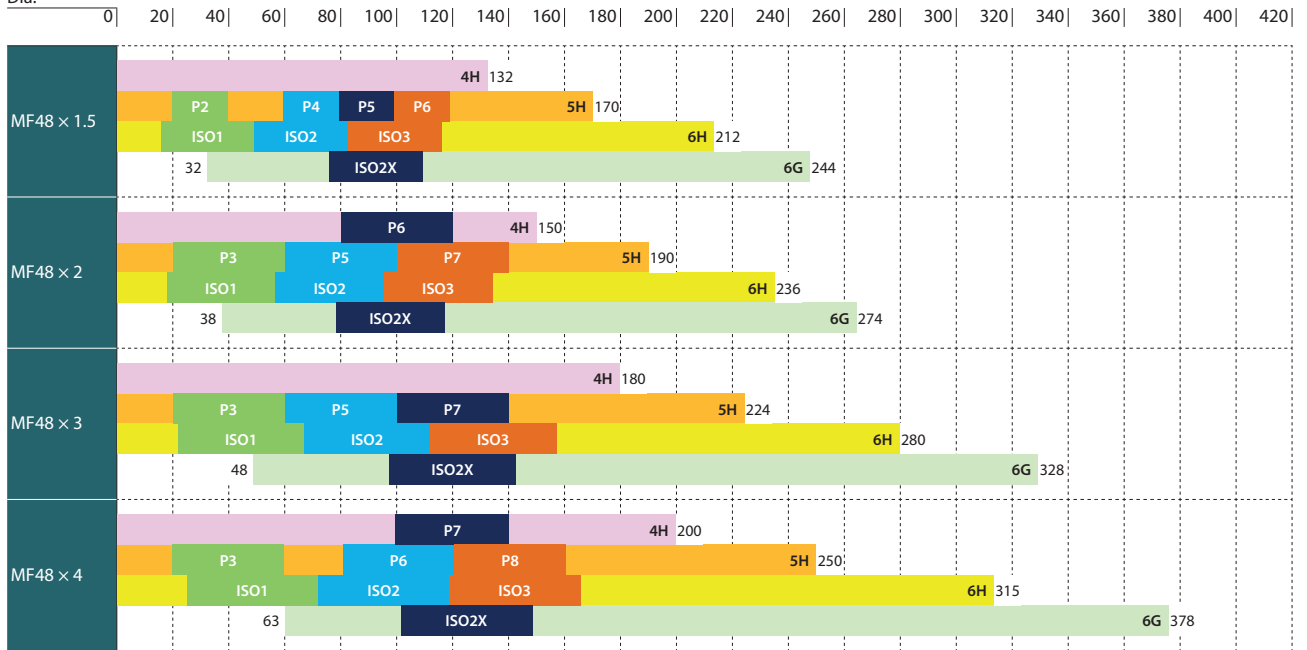

LONG

HAND,
TAPS

EG (STI)

SPECIAL
THREADS,
GAUGES

THREAD
MILLS

DIES

CENTER
DRILLS

Technical
info

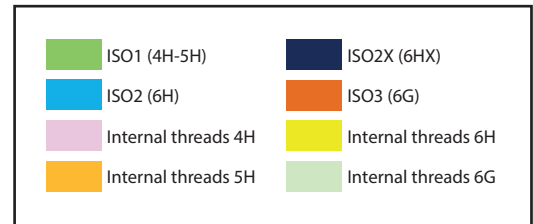

For Cutting Tap Unified Coarse Thread (UNC)

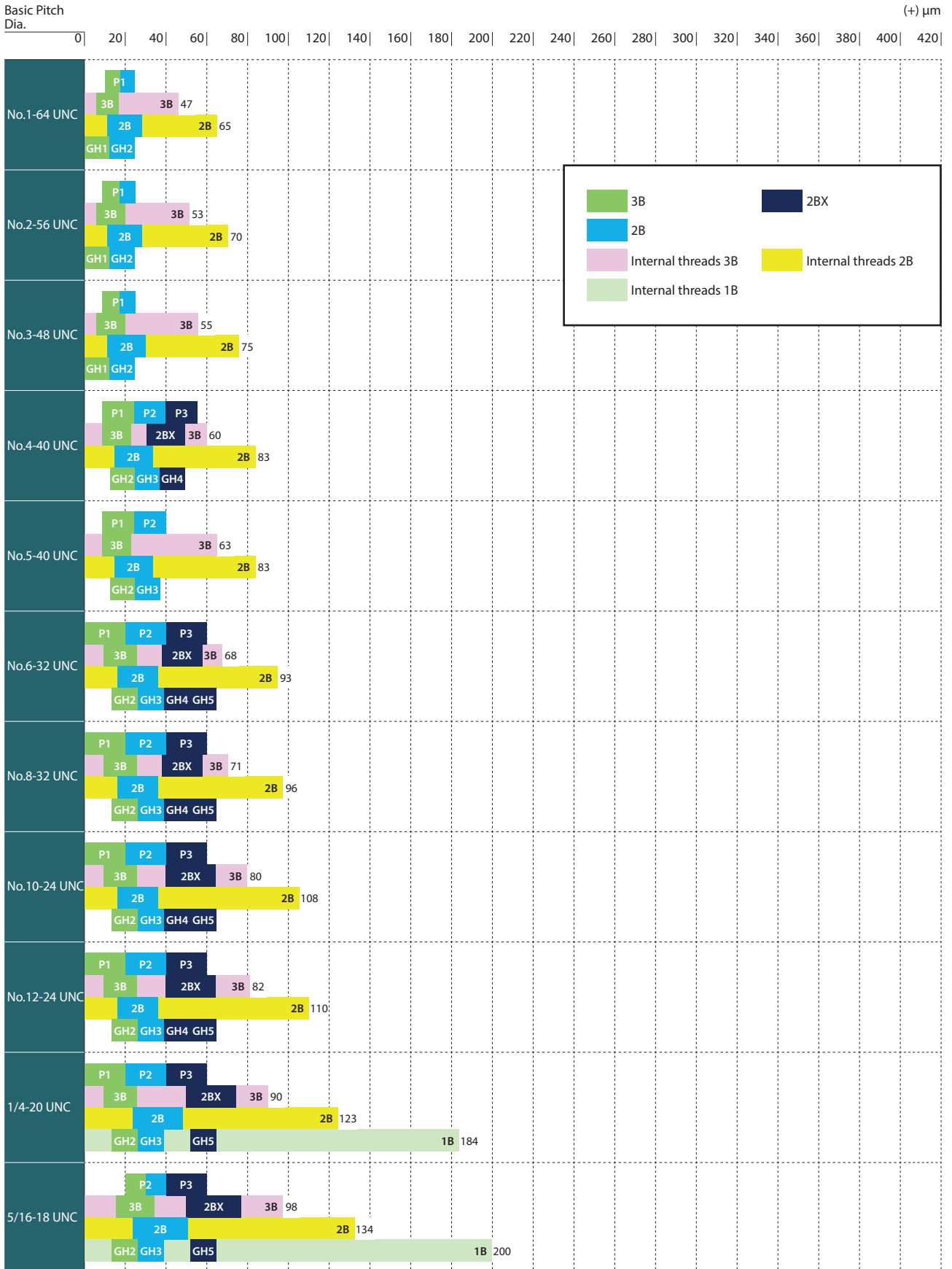

9. Comparison of pitch diameter tolerance

Intro

For Cutting Tap Unified Coarse Thread (UNC)

SP

Basic Pitch
Dia.

(+) μm

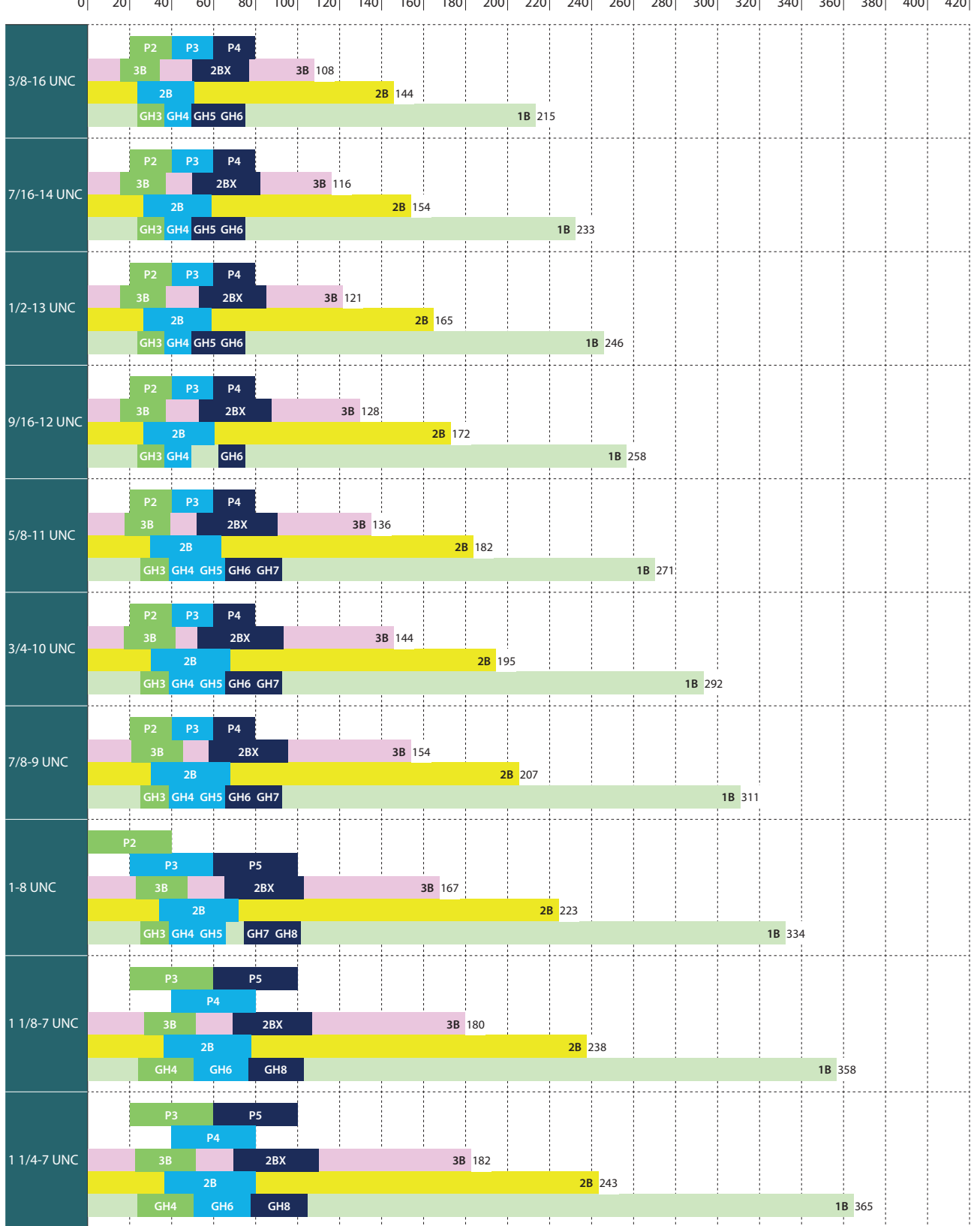

Technical info

For Cutting Tap Unified Coarse Thread (UNC)

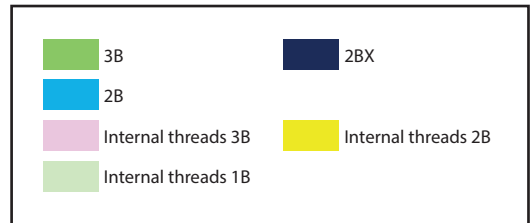
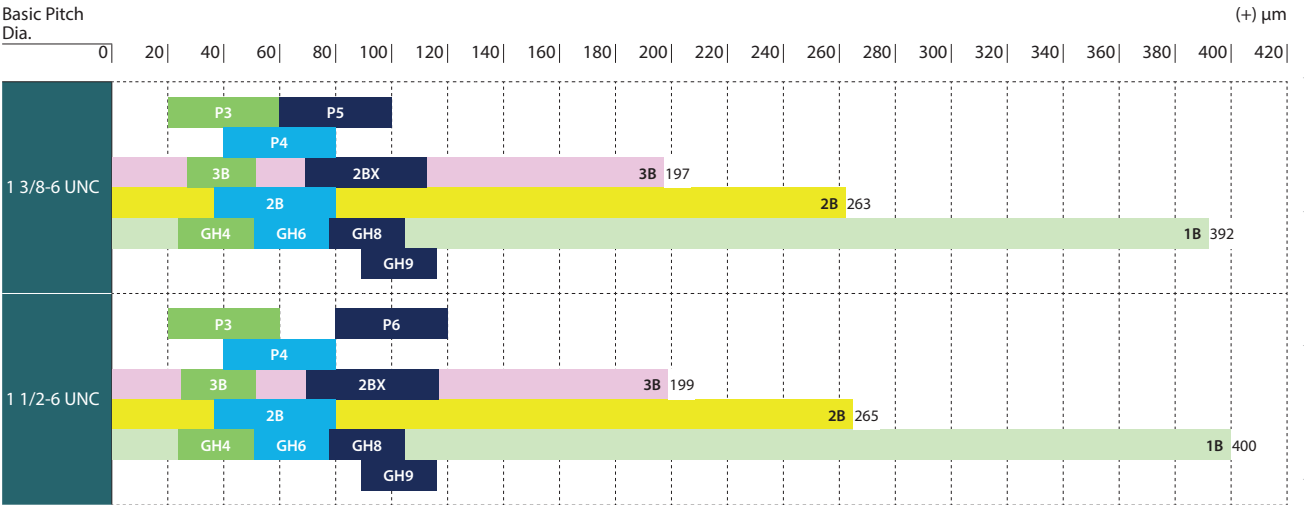

9. Comparison of pitch diameter tolerance

Intro

For Cutting Tap Unified Fine Thread (UNF)

SP

Basic Pitch
Dia.

(+) μm

0 | 20 | 40 | 60 | 80 | 100 | 120 | 140 | 160 | 180 | 200 | 220 | 240 | 260 | 280 | 300 | 320 | 340 | 360 | 380 | 400 | 420

SL

No.0-80 UNF



PO

No.1-72 UNF

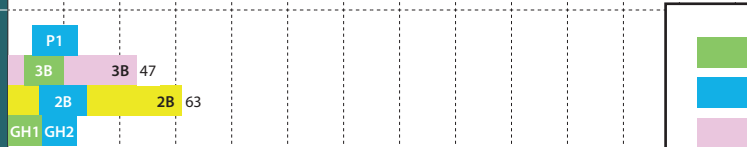

ST

No.2-64 UNF

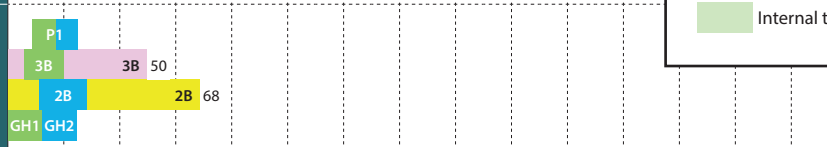

ROLL

No.3-56 UNF

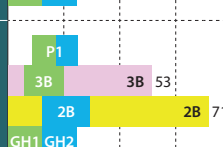

CARBIDE

No.4-48 UNF

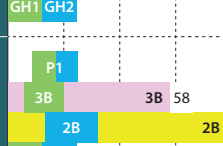

LONG

No.5-44 UNF

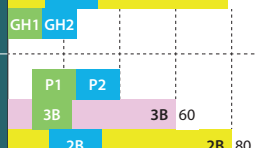

HAND, TAPS

No.6-40 UNF

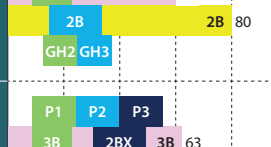

EG (STI)

No.8-36 UNF

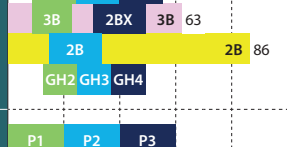

SPECIAL THREADS, GAUGES

No.10-32 UNF

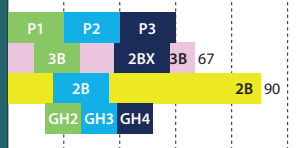

THREAD MILLS

No.12-28 UNF

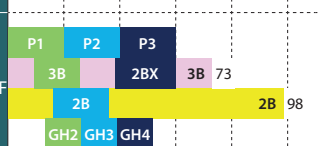

DIES

1/4-28 UNF

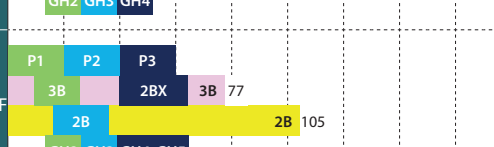

CENTER DRILLS

1/4-28 UNF

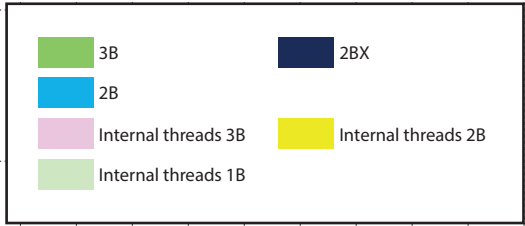

Technical info

For Cutting Tap Unified Fine Thread (UNF)

Basic Pitch Dia. (+) μm

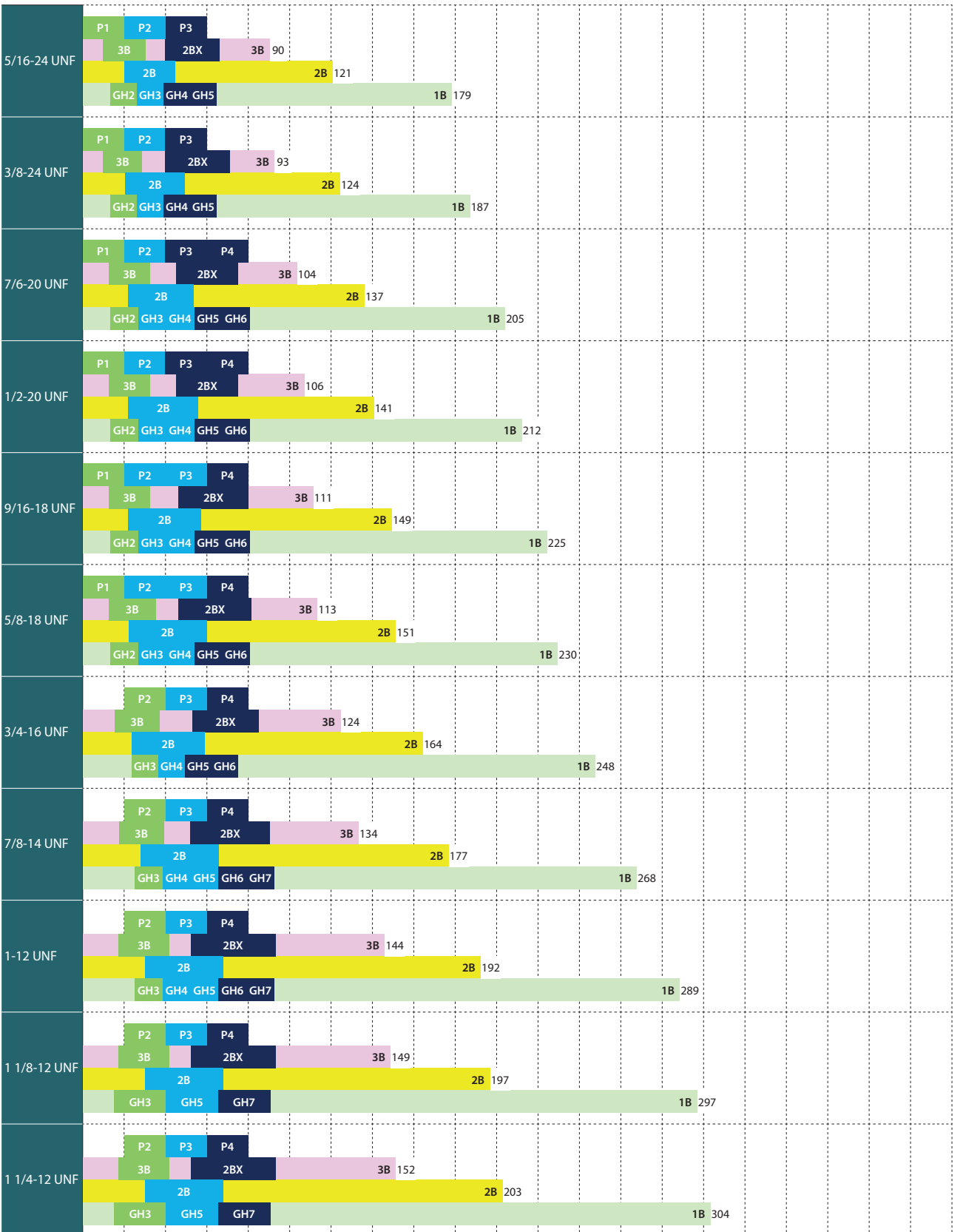

- SP
- SL
- PO
- ST
- ROLL
- CARBIDE
- LONG
- HAND TAPS
- EG (STI)
- SPECIAL THREADS, GAUGES
- THREAD MILLS
- DIES
- CENTER DRILLS

Technical info

9. Comparison of pitch diameter tolerance

Intro

For Cutting Tap Unified Fine Thread (UNF)

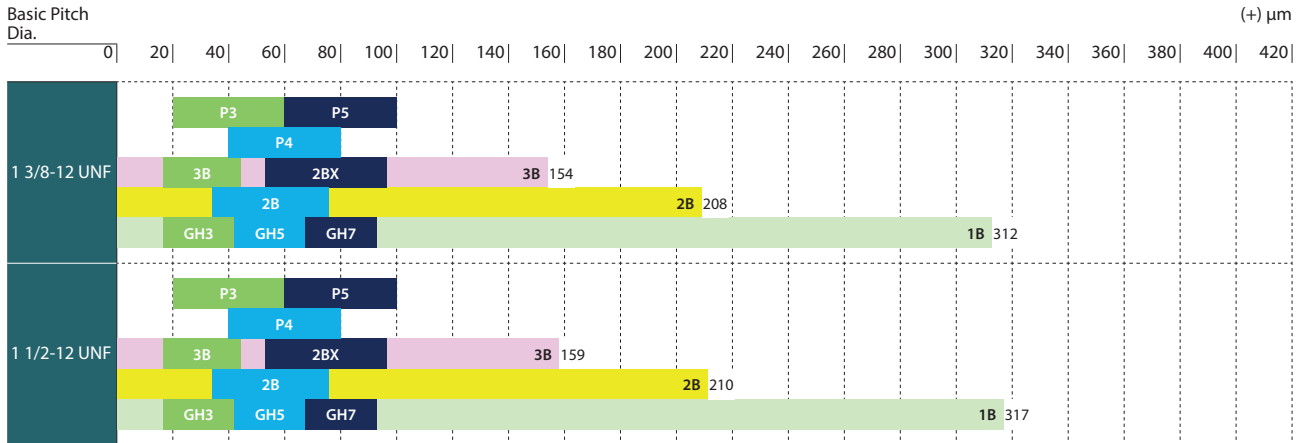

ROLL

CARBIDE

LONG

HAND,
TAPS

EG (STI)

SPECIAL
THREADS,
GAUGES

THREAD
MILLS

DIES

CENTER
DRILLS

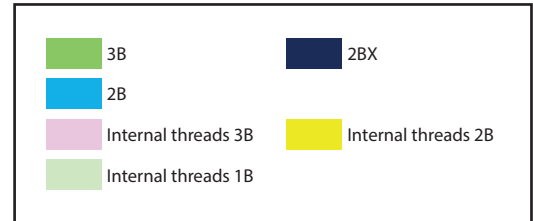

Technical
info

For Forming Tap Metric Coarse Thread (M)

Basic Pitch
Dia.

(+) μm

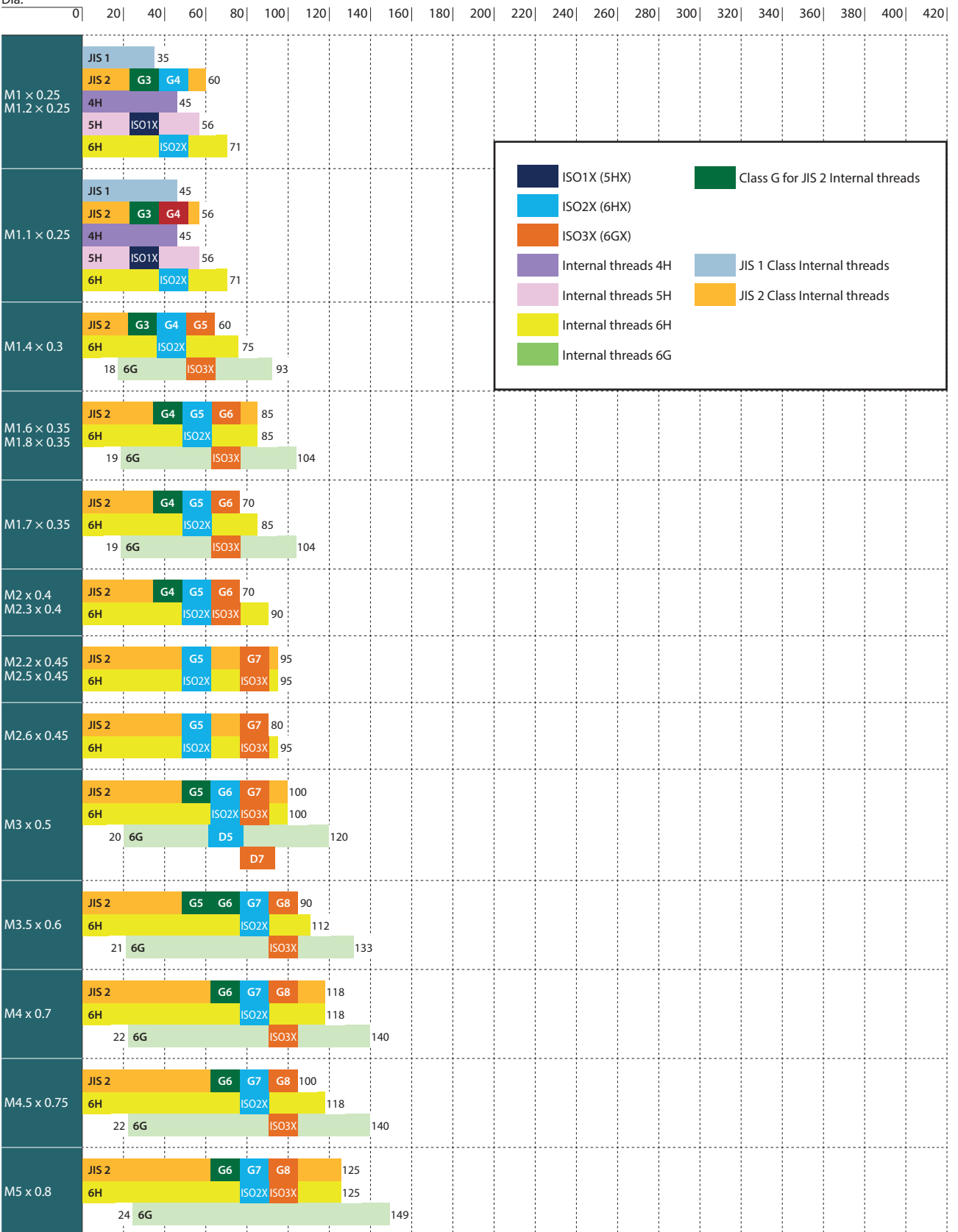

9. Comparison of pitch diameter tolerance

Intro

For Forming Tap Metric Coarse Thread (M)

SP

Basic Pitch
Dia.

(+) μm

0 | 20 | 40 | 60 | 80 | 100 | 120 | 140 | 160 | 180 | 200 | 220 | 240 | 260 | 280 | 300 | 320 | 340 | 360 | 380 | 400 | 420

SL

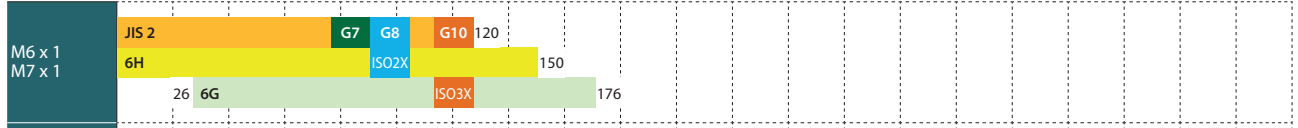

PO

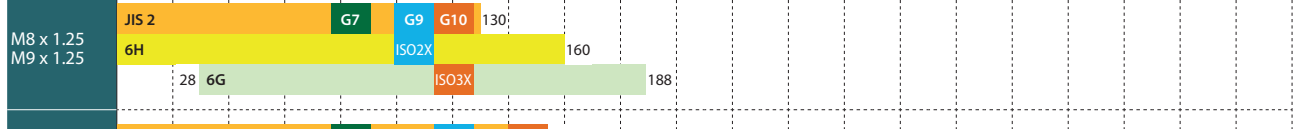

ST

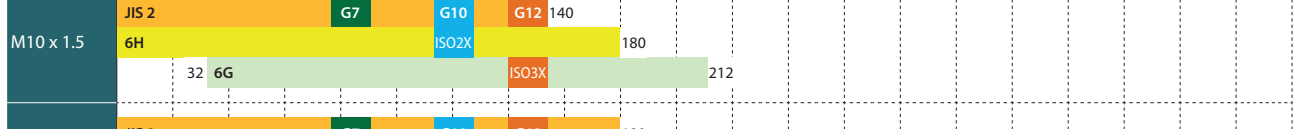

ROLL

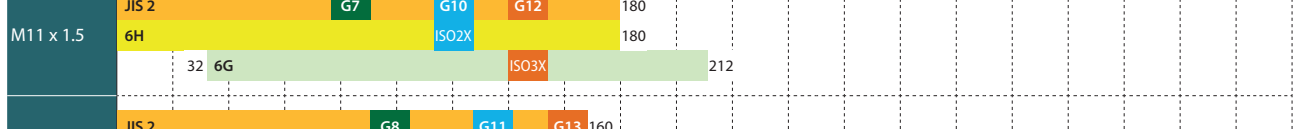

CARBIDE

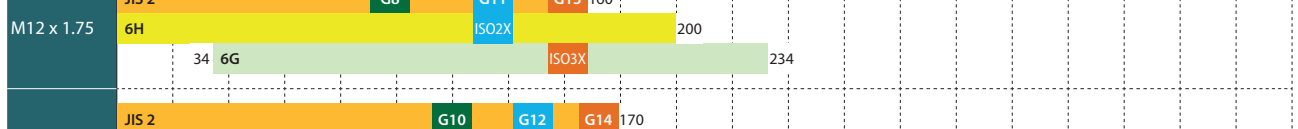

LONG

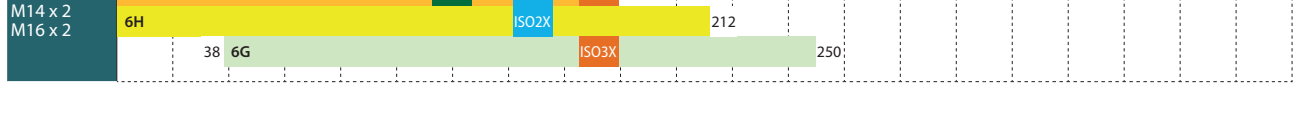

HAND,
TAPS

EG (STI)

SPECIAL
THREADS,
GAUGES

THREAD
MILLS

DIES

CENTER
DRILLS

Technical
info

For Forming Tap Metric Fine Thread (MF)

Basic Pitch
Dia.

(+) μm

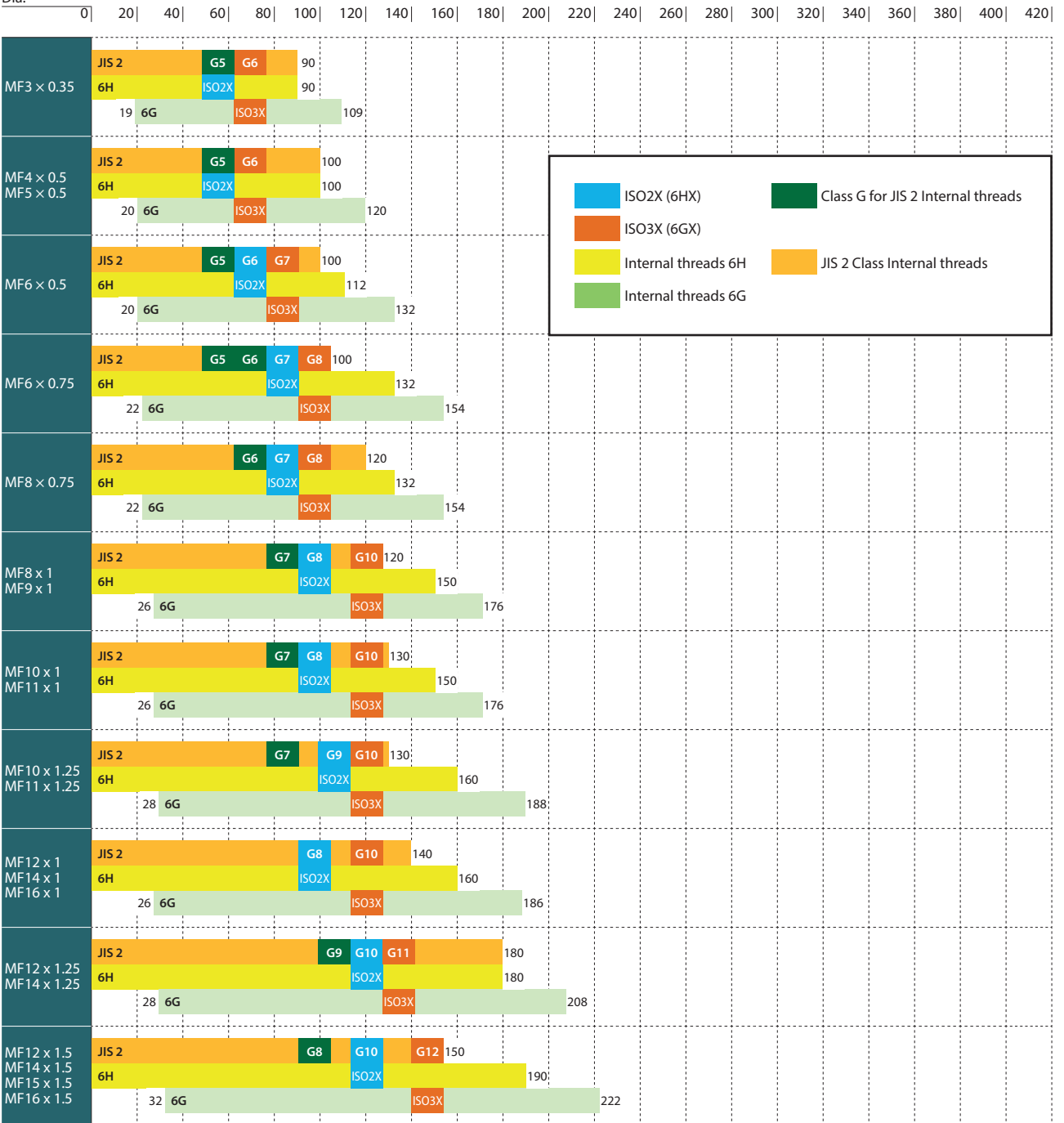

9. Comparison of pitch diameter tolerance

Intro For Forming Tap Unified Coarse Thread (UNC)

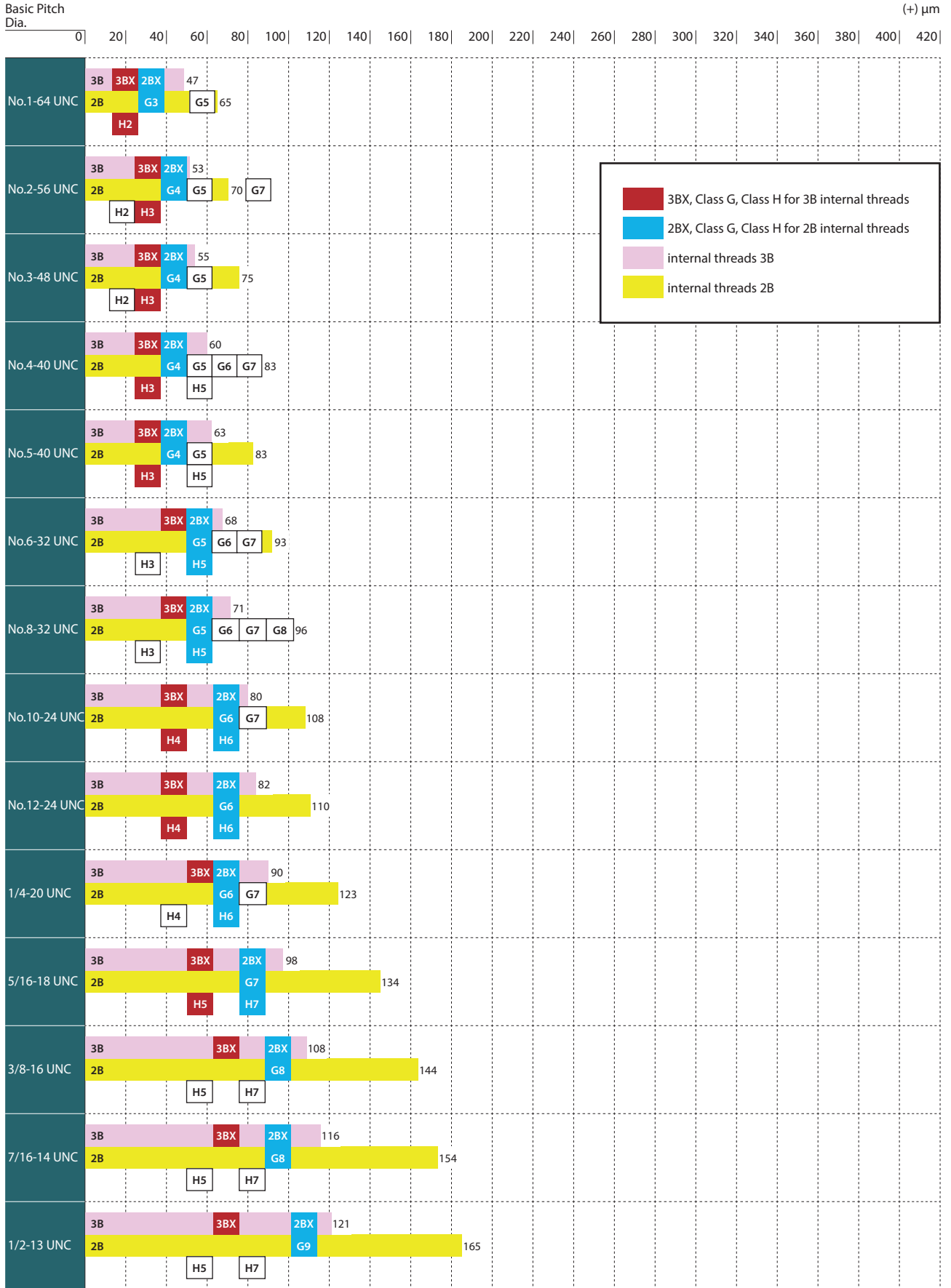

Technical info

For Forming Tap Unified Fine Thread (UNF)

Basic Pitch Dia. (+) μm

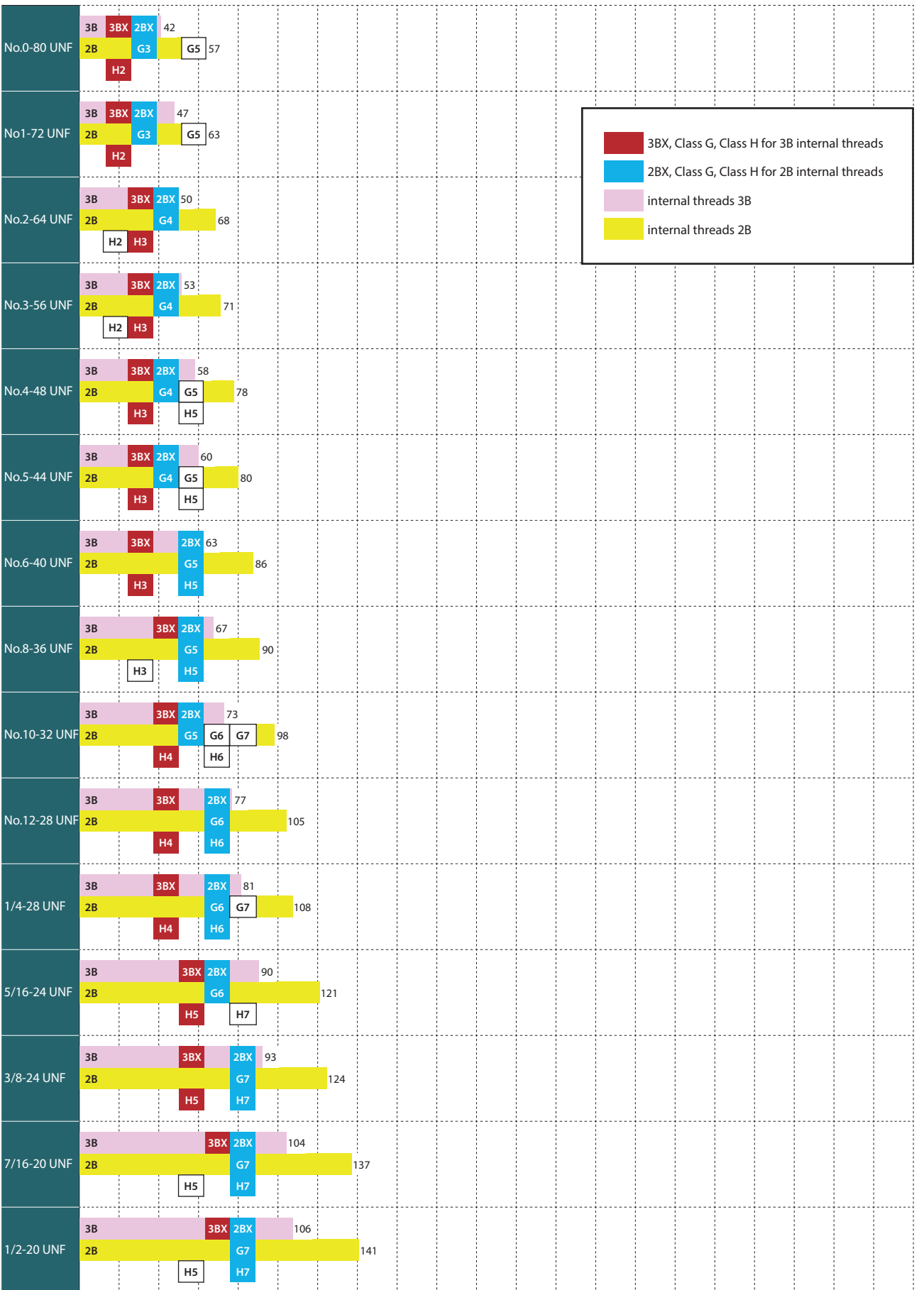

Intro

SP

SL

PO

ST

ROLL

CARBIDE

LONG

HAND TAPS

EG (STI)

SPECIAL THREADS, GAUGES

THREAD MILLS

DIES

CENTER DRILLS

Technical info

10. Tap Thread Limits (JIS, DIN, ANSI)

Intro

Metric Threads (M, MF)

Unit: mm

SP	Size	Kind of tap	Class	Major diameter		Pitch Diameter			Minor diameter
				Basic Size	Basic Size	Upper Tolerance (µm) +	Lower Tolerance (µm) +	Tolerance (µm)	Basic Size
SL	M1×0.25	cutting tap	P1	1.000	0.838	25	10	15	0.729
			ISO1			17	6	11	
			ISO2			28	17	11	
		forming tap	G3			38	26	12	
			G4			51	38	13	
			ISO1X			38	26	12	
PO	M1×0.2	cutting tap	P1	1.000	0.870	25	10	15	0.783
			ISO1			15	5	10	
			ISO2			25	15	10	
		forming tap	G4			51	38	13	
			ISO1X			38	26	12	
			ISO2X			51	38	13	
ST	M1.1×0.25	cutting tap	P1	1.100	0.938	25	10	15	0.829
			ISO1			17	6	11	
			ISO2			28	17	11	
		forming tap	G3			38	26	12	
			G4			51	38	13	
			ISO1X			38	26	12	
ROLL	M1.1×0.2	cutting tap	P1	1.100	0.970	25	10	15	0.883
			ISO1			15	5	10	
			ISO2			25	15	10	
		forming tap	G4			51	38	13	
			ISO1X			38	26	12	
			ISO2X			51	38	13	
CARBIDE	M1.2×0.25	cutting tap	P1	1.200	1.038	25	10	15	0.929
			ISO1			17	6	11	
			ISO2			28	17	11	
		forming tap	G4			51	38	13	
			ISO1X			38	26	12	
			ISO2X			51	38	13	
LONG	M1.2×0.2	cutting tap	P1	1.200	1.070	25	10	15	0.983
			ISO1			15	5	10	
			ISO2			25	15	10	
		forming tap	G3			38	26	12	
			G4			51	38	13	
			ISO1X			38	26	12	
HAND TAPS	M1.4×0.3	cutting tap	P1	1.400	1.205	25	10	15	1.075
			ISO1			18	6	12	
			ISO2			30	18	12	
		forming tap	G3			38	26	12	
			G4			51	38	13	
			G5			64	51	13	
SPECIAL THREADS, GAUGES	M1.4×0.2	cutting tap	P1	1.400	1.270	25	10	15	1.183
			ISO1			15	5	10	
			ISO2			25	15	10	
		forming tap	G3			38	26	12	
			G4			51	38	13	
			G5			64	51	13	
THREAD MILLS	M1.6×0.35	cutting tap	P1	1.600	1.373	25	10	15	1.221
			ISO1			20	7	13	
			ISO2			34	20	14	
		forming tap	G4			51	38	13	
			G5			64	51	13	
			G6			76	64	12	
DIES	M1.6×0.25	cutting tap	P1	1.600	1.373	25	10	15	1.221
			ISO1			20	7	13	
			ISO2			34	20	14	
		forming tap	G4			51	38	13	
			G5			64	51	13	
			G6			76	64	12	
CENTER DRILLS	M2×0.4	cutting tap	P1	2.000	1.740	25	10	15	1.567
			ISO1			21	7	14	
			ISO2			36	21	15	
		forming tap	G3			38	26	12	
			G4			51	38	13	
			G5			64	51	13	
SPECIAL THREADS, GAUGES	M2×0.4	cutting tap	P1	2.000	1.740	25	10	15	1.567
			ISO1			21	7	14	
			ISO2			36	21	15	
		forming tap	G3			38	26	12	
			G4			51	38	13	
			G5			64	51	13	
THREAD MILLS	M2×0.25	cutting tap	P1	2.000	1.838	25	10	15	1.729
			ISO1			18	6	12	
			ISO2			30	18	12	
		forming tap	G3			38	26	12	
			G4			51	38	13	
			G5			64	51	13	
DIES	M2.2×0.45	cutting tap	P1	2.200	1.908	25	10	15	1.713
			ISO1			23	8	15	
			ISO2			38	23	15	
		forming tap	G3			38	26	12	
			G4			51	38	13	
			G5			64	51	13	
SPECIAL THREADS, GAUGES	M2.2×0.45	cutting tap	P1	2.200	1.908	25	10	15	1.713
			ISO1			23	8	15	
			ISO2			38	23	15	
		forming tap	G3			38	26	12	
			G4			51	38	13	
			G5			64	51	13	

SP	Size	Kind of tap	Class	Major diameter		Pitch Diameter			Minor diameter
				Basic Size	Basic Size	Upper Tolerance (µm) +	Lower Tolerance (µm) +	Tolerance (µm)	Basic Size
SL	M1.6×0.2	cutting tap	P1	1.600	1.470	25	10	15	1.383
			ISO1			15	5	10	
			ISO2			25	15	10	
		forming tap	P1			25	10	15	
			P2			40	25	15	
			ISO1			20	7	13	
PO	M1.7×0.35	cutting tap	P1	1.700	1.473	25	10	15	1.321
			ISO1			20	7	13	
			ISO2			34	20	14	
		forming tap	G4			51	38	13	
			G5			64	51	13	
			G6			76	64	12	
ST	M1.7×0.2	cutting tap	P1	1.700	1.570	25	10	15	1.483
			ISO1			15	5	10	
			ISO2			25	15	10	
		forming tap	P1			25	10	15	
			P2			40	25	15	
			ISO1			20	7	13	
ROLL	M1.8×0.35	cutting tap	P1	1.800	1.573	25	10	15	1.421
			ISO1			20	7	13	
			ISO2			34	20	14	
		forming tap	G4			51	38	13	
			G5			64	51	13	
			G6			76	64	12	
CARBIDE	M1.8×0.2	cutting tap	P1	1.800	1.670	25	10	15	1.583
			ISO1			15	5	10	
			ISO2			25	15	10	
		forming tap	P1			25	10	15	
			P2			40	25	15	
			P3			55	40	15	
HAND TAPS	M2×0.4	cutting tap	P1	2.000	1.740	25	10	15	1.567
			ISO1			21	7	14	
			ISO2			36	21	15	
		forming tap	G3			38	26	12	
			G4			51	38	13	
			G5			64	51	13	
SPECIAL THREADS, GAUGES	M2×0.4	cutting tap	P1	2.000	1.740	25	10	15	1.567
			ISO1			21	7	14	
			ISO2			36	21	15	
		forming tap	G3			38	26	12	
			G4			51	38	13	
			G5			64	51	13	
THREAD MILLS	M2×0.25	cutting tap	P1	2.000	1.838	25	10	15	1.729
			ISO1			18	6	12	
			ISO2			30	18	12	
		forming tap	P1			25	10	15	
			P2			40	25	15	
			P3			55	40	15	
DIES	M2.2×0.45	cutting tap	P1	2.200	1.908	25	10	15	1.713
			ISO1			23	8	15	
			ISO2			38	23	15	
		forming tap	G3			38	26	12	
			G4			51	38	13	
			G5			64	51	13	
SPECIAL THREADS, GAUGES	M2.2×0.45	cutting tap	P1	2.200	1.908	25	10	15	1.713
			ISO1			23	8	15	
			ISO2			38	23	15	
		forming tap	G3			38	26	12	
			G4			51	38	13	
			G5			64	51	13	

Technical info

Metric Threads (M, MF)

Unit: mm

Size	Kind of tap	Class	Major diameter		Pitch Diameter			Minor diameter
			Basic Size	Basic Size	Upper Tolerance (μm) +	Lower Tolerance (μm) +	Tolerance (μm)	Basic Size
M2.2×0.25	cutting tap	P1	2.200	2.038	25	10	15	1.929
		P2			40	25	15	
		ISO1			18	6	12	
		ISO2			30	18	12	
M2.3×0.4	cutting tap	P1	2.300	2.040	25	10	15	1.867
		P2			40	25	15	
		P3			55	40	15	
		ISO1			21	7	14	
		ISO2			36	21	15	
		ISO2X			51	36	15	
M2.3×0.25	cutting tap	P1	2.300	2.138	25	10	15	2.029
		P2			40	25	15	
		ISO1			18	6	12	
		ISO2			30	18	12	
M2.5×0.45	cutting tap	P1	2.500	2.208	25	10	15	2.013
		P2			40	25	15	
		P3			55	40	15	
		ISO1			23	8	15	
		ISO2			38	23	15	
		ISO2X			53	38	15	
	forming tap	G5	64	51	13			
		G7	89	76	13			
		ISO2X	64	51	13			
		ISO3X	89	76	13			
M2.5×0.35	cutting tap	P1	2.500	2.273	25	10	15	2.121
		P2			40	25	15	
		ISO1			20	7	13	
		ISO2			34	20	14	
M2.6×0.45	cutting tap	P1	2.600	2.308	25	10	15	2.113
		P2			40	25	15	
		P3			55	40	15	
		ISO1			23	8	15	
		ISO2			38	23	15	
		ISO2X			53	38	15	
	forming tap	G5	64	51	13			
		G7	89	76	13			
		ISO2X	64	51	13			
		ISO3X	89	76	13			
M2.6×0.35	cutting tap	P1	2.600	2.373	25	10	15	2.221
		P2			40	25	15	
		ISO1			20	7	13	
		ISO2			34	20	14	
M3×0.5	cutting tap	P1	3.000	2.675	25	10	15	2.459
		P2			40	25	15	
		P3			55	40	15	
		ISO1			24	8	16	
		ISO2			40	24	16	
		ISO2X			55	39	16	
	forming tap	ISO3	56	40	16			
		G5	64	51	13			
		G6	76	64	12			
		G7	89	76	13			
forming tap	ISO2X	76	64	12				
	ISO3X	89	76	13				

Size	Kind of tap	Class	Major diameter		Pitch Diameter			Minor diameter	
			Basic Size	Basic Size	Upper Tolerance (μm) +	Lower Tolerance (μm) +	Tolerance (μm)	Basic Size	
M3×0.35	cutting tap	P1	3.000	2.773	25	10	15	2.621	
		P2			40	25	15		
		ISO1			21	7	14		
		ISO2			36	21	15		
	forming tap	G5	64	51	13				
		G6	76	64	12				
M3.5×0.6	cutting tap	P1	3.500	3.110	25	10	15	2.850	
		P2			40	25	15		
		P3			55	40	15		
		ISO1			27	9	18		
		ISO2			45	27	18		
		ISO2X			60	42	18		
	forming tap	ISO3	63	45	18				
		G5	64	51	13				
		G6	76	64	12				
		G7	89	76	13				
forming tap	G8	102	89	13					
	ISO2X	89	76	13					
	ISO3X	102	89	13					
	M3.5×0.35	cutting tap	P1	3.500	3.273	25	10	15	3.121
P2			40			25	15		
ISO1			21			7	14		
ISO2			36			21	15		
M4×0.7	cutting tap	P1	4.000	3.545	20	0	20	3.242	
		P2			40	20	20		
		P3			60	40	20		
		ISO1			29	10	19		
		ISO2			48	29	19		
		ISO2X			63	44	19		
	forming tap	ISO3	67	48	19				
		G6	76	64	13				
		G7	89	76	13				
		G8	102	89	13				
forming tap	ISO2X	89	76	13					
	ISO3X	102	89	13					
	M4×0.5	cutting tap	P1	4.000	3.675	25	10	15	3.459
			P2			40	25	15	
P3			55			40	15		
ISO1			24			8	16		
forming tap		ISO2	40			24	16		
		ISO3	56			40	16		
G5	64	51	13						
G6	76	64	12						
G7	89	76	13						
ISO2X	64	51	13						
ISO3X	76	64	12						

SP

SL

PO

ST

ROLL

CARBIDE

LONG

HAND TAPS

EG (STI)

SPECIAL THREADS, GAUGES

THREAD MILLS

DIES

CENTER DRILLS

Technical info

10. Tap Thread Limits (JIS, DIN, ANSI)

Intro

Metric Threads (M, MF)

Unit: mm

SP	Size	Kind of tap	Class	Major diameter		Pitch Diameter			Minor diameter
				Basic Size	Basic Size	Upper Tolerance (μm) +	Lower Tolerance (μm) +	Tolerance (μm)	Basic Size
SL	M4.5×0.75	cutting tap	P1	4.500	4.013	20	0	20	3.688
			P2			40	20	20	
			P3			60	40	20	
			ISO1			29	10	19	
			ISO2			48	29	19	
			ISO2X			63	44	19	
			ISO3			67	48	19	
		forming tap	G6	76	64	13			
			G7	89	76	13			
			G8	102	89	13			
ST		forming tap	ISO2X			89	76	13	
			ISO3X			102	89	13	
ROLL	M4.5×0.5	cutting tap	P1	4.500	4.175	25	10	15	3.959
			P2			40	25	15	
			P3			55	40	15	
			ISO1			24	8	16	
			ISO2			40	24	16	
			ISO3			56	40	16	
CARBIDE	M5×0.8	cutting tap	P1	5.000	4.480	20	0	20	4.134
			P2			40	20	20	
			P3			60	40	20	
			ISO1			30	10	20	
			ISO2			50	30	20	
			ISO2X			70	50	20	
			ISO3			70	50	20	
		forming tap	G7	89	76	13			
			G8	102	89	13			
			ISO2X	89	76	13			
HAND TAPS		forming tap	ISO3X			102	89	13	
EG (STI)	M5×0.5	cutting tap	P1	5.000	4.675	25	10	15	4.459
			P2			40	25	15	
			P3			55	40	15	
			ISO1			24	8	16	
			ISO2			40	24	16	
			ISO3			56	40	16	
			forming tap			G5	64	51	
		G6		76	64	12			
		ISO2X		64	51	13			
		SPECIAL THREADS, GAUGES		forming tap	ISO3X			76	64
THREAD MILLS	M5.5×0.5	cutting tap	P1	5.500	5.175	25	10	15	4.959
			P2			40	25	15	
			P3			55	40	15	
			ISO1			24	8	16	
			ISO2			40	24	16	
DIES			ISO3			56	40	16	

SP	Size	Kind of tap	Class	Major diameter		Pitch Diameter			Minor diameter
				Basic Size	Basic Size	Upper Tolerance (μm) +	Lower Tolerance (μm) +	Tolerance (μm)	Basic Size
SL	M6×1	cutting tap	P2	6.000	5.350	40	20	20	4.917
			P3			60	40	20	
			P4			80	60	20	
			ISO1			35	12	23	
			ISO2			59	35	24	
			ISO2X			79	55	24	
			ISO3			83	59	24	
		forming tap	G7	89	76	13			
			G8	102	89	13			
			G10	127	114	13			
ST		forming tap	ISO2X			102	89	13	
			ISO3X			127	114	13	
ROLL	M6×0.75	cutting tap	P2	6.000	5.513	40	20	20	5.188
			P3			60	40	20	
			P4			80	60	20	
			ISO1			32	11	21	
			ISO2			53	32	21	
			ISO3			74	53	21	
		forming tap	G5	64	51	13			
			G6	76	64	12			
			G7	89	76	13			
			G8	102	89	13			
HAND TAPS		forming tap	ISO2X			89	76	13	
			ISO3X			102	89	13	
EG (STI)	M6×0.5	cutting tap	P1	6.000	5.675	25	10	15	5.459
			P2			40	25	15	
			P3			55	40	15	
			ISO1			27	9	18	
			ISO2			45	27	18	
			ISO3			63	45	18	
			forming tap			G5	64	51	
		G6		76	64	12			
		G7		89	76	13			
		SPECIAL THREADS, GAUGES		forming tap	ISO2X			76	64
ISO3X						89	76	13	

CENTER DRILLS

Technical info

Metric Threads (M, MF)

Unit: mm

Size	Kind of tap	Class	Major diameter		Pitch Diameter			Minor diameter	
			Basic Size	Basic Size	Upper Tolerance (μm) +	Lower Tolerance (μm) +	Tolerance (μm)	Basic Size	
M7×1	cutting tap	P2	7.000	6.350	40	20	20	5.917	
		P3			60	40	20		
		P4			80	60	20		
		ISO1			35	12	23		
		ISO2			59	35	24		
		ISO2X			79	55	24		
	forming tap	ISO3			83	59	24		
		G8			102	89	13		
		G10			127	114	13		
		ISO2X			102	89	13		
		ISO3X			127	114	13		
M7×0.75	cutting tap	P2	7.000	6.513	40	20	20	6.188	
		P3			60	40	20		
		P4			80	60	20		
		ISO1			32	11	21		
		ISO2			53	32	21		
		ISO3			74	53	21		
M7×0.5	cutting tap	P1	7.000	6.675	25	10	15	6.459	
		P2			40	25	15		
		P3			55	40	15		
		ISO1			27	9	18		
		ISO2			45	27	18		
		ISO3			63	45	18		
M8×1.25	cutting tap	P2	8.000	7.188	40	20	20	6.647	
		P3			60	40	20		
		P4			80	60	20		
		ISO1			38	13	25		
		ISO2			63	38	25		
		ISO2X			88	63	25		
	forming tap	ISO3			88	63	25		
		G9			114	102	12		
		G10			127	114	13		
		ISO2X			114	102	12		
		ISO3X			127	114	13		
M8×1	cutting tap	P2	8.000	7.350	40	20	20	6.917	
		P3			60	40	20		
		P4			80	60	20		
		ISO1			35	12	23		
		ISO2			59	35	24		
		ISO2X			79	55	24		
		ISO3			83	59	24		
		forming tap			G7	89	76		13
					G8	102	89		13
	G10				127	114	13		
	ISO2X				102	89	13		
	ISO3X				127	114	13		

Size	Kind of tap	Class	Major diameter		Pitch Diameter			Minor diameter
			Basic Size	Basic Size	Upper Tolerance (μm) +	Lower Tolerance (μm) +	Tolerance (μm)	Basic Size
M8×0.75	cutting tap	P2	8.000	7.513	40	20	20	7.188
		P3			60	40	20	
		P4			80	60	20	
		ISO1			32	11	21	
		ISO2			53	32	21	
		ISO3			74	53	21	
	forming tap	G6			76	64	12	
		G7			89	76	13	
		G8			102	89	13	
		ISO2X			89	76	13	
		ISO3X			102	89	13	
M8×0.5	cutting tap	P1	8.000	7.675	25	10	15	7.459
		P2			40	25	15	
		P3			55	40	15	
		ISO1			27	9	18	
		ISO2			45	27	18	
		ISO3			63	45	18	
M9×1.25	cutting tap	P2	9.000	8.188	40	20	20	7.647
		P3			60	40	20	
		P4			80	60	20	
		ISO1			38	13	25	
		ISO2			63	38	25	
		ISO2X			88	63	25	
	forming tap	ISO3			88	63	25	
		G7			89	76	13	
		G9			114	102	12	
		G10			127	114	13	
		ISO2X			114	102	12	
		ISO3X			127	114	13	
M9×1	cutting tap	P2	9.000	8.350	40	20	20	7.917
		P3			60	40	20	
		P4			80	60	20	
		ISO1			35	12	23	
		ISO2			59	35	24	
		ISO2X			79	55	24	
	forming tap	ISO3			83	59	24	
		G8			102	89	13	
		G10			127	114	13	
		ISO2X			102	89	13	
ISO3X	127	114	13					

- SP
- SL
- PO
- ST
- ROLL
- CARBIDE
- LONG
- HAND TAPS
- EG (STI)
- SPECIAL THREADS, GAUGES
- THREAD MILLS
- DIES
- CENTER DRILLS

10. Tap Thread Limits (JIS, DIN, ANSI)

Intro

Metric Threads (M, MF)

Unit: mm

SP

SL

PO

ST

ROLL

CARBIDE

LONG

HAND TAPS

EG (STI)

SPECIAL THREADS, GAUGES

THREAD MILLS

DIES

CENTER DRILLS

Size	Kind of tap	Class	Major diameter		Pitch Diameter			Minor diameter	
			Basic Size	Basic Size	Upper Tolerance (μm) +	Lower Tolerance (μm) +	Tolerance (μm)	Basic Size	
M9×0.75	cutting tap	P2	9.000	8.513	40	20	20	8.188	
		P3			60	40	20		
		P4			80	60	20		
		ISO1			32	11	21		
		ISO2			53	32	21		
		ISO3			74	53	21		
M10×1.5	cutting tap	P2	10.000	9.026	40	20	20	8.376	
		P3			60	40	20		
		P5			100	80	20		
		ISO1			42	14	28		
		ISO2			70	42	28		
		ISO2X			95	67	28		
	forming tap	ISO3	98	70	28				
		G10	127	114	13				
		G12	152	140	12				
		ISO2X	127	114	13				
		ISO3X	152	140	12				
M10×1.25	cutting tap	P2	10.000	9.188	40	20	20	8.647	
		P3			60	40	20		
		P4			80	60	20		
		ISO1			38	13	25		
		ISO2			63	38	25		
		ISO2X			88	63	25		
	forming tap	ISO3	88	63	25				
		G7	89	76	13				
		G9	114	102	12				
		G10	127	114	13				
		ISO2X	114	102	12				
		ISO3X	127	114	13				
M10×1	cutting tap	P2	10.000	9.350	40	20	20	8.917	
		P3			60	40	20		
		P4			80	60	20		
		ISO1			35	12	23		
		ISO2			59	35	24		
		ISO2X			79	55	24		
	forming tap	ISO3	83	59	24				
		G7	89	76	13				
		G8	102	89	13				
		G10	127	114	13				
		ISO2X	102	89	13				
		ISO3X	127	114	13				
M10×0.75	cutting tap	P2	10.000	9.513	40	20	20	9.188	
		P3			60	40	20		
		P4			80	60	20		
		ISO1			32	11	21		
		ISO2			53	32	21		
		ISO3			74	53	21		

Size	Kind of tap	Class	Major diameter		Pitch Diameter			Minor diameter
			Basic Size	Basic Size	Upper Tolerance (μm) +	Lower Tolerance (μm) +	Tolerance (μm)	Basic Size
M10×0.5	cutting tap	P1	10.000	9.675	25	10	15	9.459
		P2			40	25	15	
		P3			55	40	15	
		ISO1			27	9	18	
		ISO2			45	27	18	
		ISO3			63	45	18	
M11×1.5	cutting tap	P2	11.000	10.026	40	20	20	9.376
		P3			60	40	20	
		P5			100	80	20	
		ISO1			42	14	28	
		ISO2			70	42	28	
		ISO2X			95	67	28	
	forming tap	ISO3	98	70	28			
		G7	89	76	13			
		G10	127	114	13			
		ISO2X	127	114	13			
		ISO3X	152	140	12			
M11×1	cutting tap	P2	11.000	10.350	40	20	20	9.917
		P3			60	40	20	
		P4			80	60	20	
		ISO1			35	12	23	
		ISO2			59	35	24	
		ISO2X			79	55	24	
	forming tap	ISO3	83	59	24			
		G7	89	76	13			
		G8	102	89	13			
		G10	127	114	13			
		ISO2X	102	89	13			
		ISO3X	127	114	13			
M11×0.75	cutting tap	P2	11.000	10.513	40	20	20	10.188
		P3			60	40	20	
		P4			80	60	20	
		ISO1			32	11	21	
		ISO2			53	32	21	
		ISO3			74	53	21	
M12×1.75	cutting tap	P2	12.000	10.863	40	20	20	10.106
		P4			80	60	20	
		P5			100	80	20	
		ISO1			48	16	32	
		ISO2			80	48	32	
		ISO2X			105	73	32	
	forming tap	ISO3	112	80	32			
		G8	102	89	13			
		G11	140	127	13			
		G13	165	152	13			
		ISO2X	140	127	13			
		ISO3X	165	152	13			

Technical info

Metric Threads (M, MF)

Unit: mm

Size	Kind of tap	Class	Major diameter		Pitch Diameter			Minor diameter					
			Basic Size	Basic Size	Upper Tolerance (µm) +	Lower Tolerance (µm) +	Tolerance (µm)	Basic Size					
M12×1.5	cutting tap	P2	12.000	11.026	40	20	20	10.376					
		P4			80	60	20						
		P5			100	80	20						
		ISO1			45	15	30						
		ISO2			75	45	30						
		ISO2X			100	70	30						
		ISO3			105	75	30						
	forming tap	G8			102	89	13						
		G10			127	114	13						
		G12			152	140	12						
		ISO2X			127	114	13						
		ISO3X			152	140	12						
		M12×1.25			cutting tap	P2	12.000		11.188	40	20	20	10.647
						P3				60	40	20	
P4	80		60	20									
P5	100		80	20									
ISO1	42		14	28									
ISO2	70		42	28									
ISO2X	95		67	28									
forming tap	ISO3		98	70	28								
	G9		114	102	13								
	G10		127	114	13								
	G11		140	127	13								
	ISO2X		127	114	13								
	ISO3X		140	127	13								
	M12×1		cutting tap	P2	12.000	11.350		40		20	20	10.917	
P3		60		40			20						
P4		80		60			20						
ISO1		38		13			25						
ISO2		63		38			25						
ISO2X		83		58			25						
ISO3		88		63			25						
forming tap		G8	102	89			13						
		G10	127	114			13						
		ISO2X	102	89			13						
		ISO3X	127	114			13						
		M12×0.75	cutting tap	P2			12.000	11.513	40	20	20		11.188
				P3					60	40	20		
				P4					80	60	20		
ISO1	34			11	23								
ISO2	56			34	22								
ISO3	78			56	22								
forming tap	G8			102	89	13							
	G10		127	114	13								
	ISO2X		102	89	13								
	ISO3X		127	114	13								
	M14×2		cutting tap	P2	14.000	12.701			40	20	20	11.835	
				P4					80	60	20		
				P5					100	80	20		
P6				120					100	20			
ISO1		51		17			34						
ISO2		85		51			34						
ISO2X		110		76			34						
forming tap		ISO3	119	85			34						

Size	Kind of tap	Class	Major diameter		Pitch Diameter			Minor diameter					
			Basic Size	Basic Size	Upper Tolerance (µm) +	Lower Tolerance (µm) +	Tolerance (µm)	Basic Size					
M14×2	forming tap	G10	14.000	12.701	127	114	13	11.835					
		G12			152	140	12						
		G14			178	165	13						
		ISO2X			152	140	12						
		ISO3X			178	165	13						
		M14×1.5			cutting tap	P2	14.000		13.026	40	20	20	12.376
P3	60		40	20									
P5	100		80	20									
ISO1	45		15	30									
ISO2	75		45	30									
ISO2X	100		70	30									
ISO3	105		75	30									
forming tap	G9		114	102	13								
	G10		127	114	13								
	G12		152	140	12								
	ISO2X		127	114	13								
	ISO3X		152	140	12								
	M14×1.25		cutting tap	P2	14.000	13.188		40		20	20	12.647	
				P3				60		40	20		
P4		80		60			20						
P5		100		80			20						
ISO1		42		14			28						
ISO2		70		42			28						
ISO2X		95		67			28						
forming tap		ISO3	98	70			28						
		G9	114	102			13						
		G10	127	114			13						
		G11	140	127			13						
		ISO2X	127	114			13						
		ISO3X	140	127			13						
		M14×1	cutting tap	P2			14.000	13.350	40	20	20		12.917
P3	60			40	20								
P4	80			60	20								
ISO1	38			13	25								
ISO2	63			38	25								
ISO2X	83			58	25								
ISO3	88			63	25								
forming tap	G8		102	89	13								
	G10		127	114	13								
	ISO2X		102	89	13								
	ISO3X		127	114	13								
	M15×1.5		cutting tap	P2	15.000	14.026			40	20	20	13.376	
				P3					60	40	20		
				P5					100	80	20		
ISO1		45		15			30						
ISO2		75		45			30						
ISO2X		100		70			30						
ISO3		105		75			30						
forming tap		G9	114	102			13						
		G10	127	114			13						
		G12	152	140			12						
		ISO2X	127	114			13						
		ISO3X	152	140			12						

- SP
- SL
- PO
- ST
- ROLL
- CARBIDE
- LONG
- HAND TAPS
- EG (STI)
- SPECIAL THREADS, GAUGES
- THREAD MILLS
- DIES
- CENTER DRILLS

Technical info

10. Tap Thread Limits (JIS, DIN, ANSI)

Intro

Metric Threads (M, MF)

Unit: mm

SP	Size	Kind of tap	Class	Major diameter		Pitch Diameter			Minor diameter						
				Basic Size	Basic Size	Upper Tolerance (μm) +	Lower Tolerance (μm) +	Tolerance (μm)	Basic Size						
SL	M16x2	cutting tap	P2	16.000	14.701	40	20	20	13.835						
			P4			80	60	20							
			P5			100	80	20							
			P6			120	100	20							
			ISO1			51	17	34							
			ISO2			85	51	34							
			ISO2X			110	76	34							
			ISO3			119	85	34							
			ST			forming tap	G10	16.000		14.701	127	114	13	13.835	
							G12				152	140	12		
G14	178	165		13											
ISO2X	152	140		12											
ISO3X	178	165		13											
G12	156	115		41											
ROLL	M16x1.5	cutting tap	P2	16.000	15.026	40	20	20	14.376						
			P3			60	40	20							
			P5			100	80	20							
			ISO1			45	15	30							
			ISO2			75	45	30							
			ISO2X			100	70	30							
			ISO3			105	75	30							
			CARBIDE			forming tap	G9	16.000		15.026	114	102	13	14.376	
							G10				127	114	13		
							G12				152	140	12		
ISO2X	127	114		13											
ISO3X	152	140		12											
G12	156	115		41											
LONG	M16x1.5	cutting tap	P2	16.000	15.026	40	20	20	14.376						
			P3			60	40	20							
			P5			100	80	20							
			ISO1			45	15	30							
			ISO2			75	45	30							
			ISO2X			100	70	30							
			ISO3			105	75	30							
			HAND TAPS			forming tap	G9	16.000		15.026	114	102	13	14.376	
							G10				127	114	13		
							G12				152	140	12		
ISO2X	127	114		13											
ISO3X	152	140		12											
G12	156	115		41											
EG (STI)	M16x1	cutting tap	P2	16.000	15.350	40	20	20	14.917						
			P3			60	40	20							
			P4			80	60	20							
			ISO1			38	13	25							
			ISO2			63	38	25							
			ISO2X			83	58	25							
			ISO3			88	63	25							
			SPECIAL THREADS, GAUGES			forming tap	G8	16.000		15.350	102	89	13	14.917	
							G10				127	114	13		
							ISO2X				102	89	13		
ISO3X	127	114		13											
G10	127	114		13											
G12	152	140		12											
THREAD MILLS	M18x2.5	cutting tap	P2	18.000	16.376	40	20	20	15.294						
			P4			80	60	20							
			P5			100	80	20							
			P6			120	100	20							
			ISO1			54	18	36							
			ISO2			90	54	36							
			ISO2X			115	79	36							
			ISO3			126	90	36							
			DIES			M18x2	cutting tap	P2		18.000	16.701	40	20	20	15.835
								P4				80	60	20	
P5	100	80		20											
P6	120	100		20											
ISO1	51	17		34											
ISO2	85	51		34											
ISO2X	110	76		34											
ISO3	119	85		34											

SP	Size	Kind of tap	Class	Major diameter		Pitch Diameter			Minor diameter						
				Basic Size	Basic Size	Upper Tolerance (μm) +	Lower Tolerance (μm) +	Tolerance (μm)	Basic Size						
SL	M18x1.5	cutting tap	P2	18.000	17.026	40	20	20	16.376						
			P3			60	40	20							
			P5			100	80	20							
			ISO1			45	15	30							
			ISO2			75	45	30							
			ISO2X			100	70	30							
			ISO3			105	75	30							
			ST			M18x1	cutting tap	P2		18.000	17.350	40	20	20	16.917
								P3				60	40	20	
								P4				80	60	20	
ISO1	38	13		25											
ISO2	63	38		25											
ISO2X	83	58		25											
ROLL	M20x2.5	cutting tap	P2	20.000	18.376	40	20	20	17.294						
			P4			80	60	20							
			P5			100	80	20							
			P6			120	100	20							
			ISO1			54	18	36							
			ISO2			90	54	36							
CARBIDE	forming tap	G9	20.000	18.701	114	102	13	17.835							
		G10			127	114	13								
		G12			152	140	12								
		ISO2X			127	114	13								
		ISO3X			152	140	12								
		G12			156	115	41								
LONG	M20x2	cutting tap	P2	20.000	18.701	40	20	20	17.835						
			P4			80	60	20							
			P5			100	80	20							
			P6			120	100	20							
			ISO1			51	17	34							
			ISO2			85	51	34							
			ISO2X			110	76	34							
			ISO3			119	85	34							
			EG (STI)			M20x1.5	cutting tap	P2		20.000	19.026	40	20	20	18.376
								P3				60	40	20	
P5	100	80		20											
ISO1	45	15		30											
ISO2	75	45		30											
ISO2X	100	70		30											
ISO3	105	75		30											
HAND TAPS	M20x1	cutting tap		P2	20.000			19.350	40			20	20	18.917	
				P3					60			40	20		
				P4					80			60	20		
			ISO1	38		13	25								
			ISO2	63		38	25								
			ISO2X	83		58	25								
			ISO3	88		63	25								
			SPECIAL THREADS, GAUGES	forming tap		G9	20.000		18.701	114	102	13	17.835		
						G10				127	114	13			
						ISO2X				127	114	13			
ISO3X	152	140			12										
G10	127	114			13										
G12	152	140			12										
ISO2X	127	114			13										
ISO3X	152	140			12										
THREAD MILLS	M22x2.5	cutting tap	P2	22.000	20.376	40	20	20	19.294						
			P4			80	60	20							
			P6			120	100	20							
			ISO1			54	18	36							
			ISO2			90	54	36							
			ISO2X			115	79	36							
			ISO3			126	90	36							

Technical info

Metric Threads (M, MF)

Unit: mm

Size	Kind of tap	Class	Major diameter		Pitch Diameter			Minor diameter
			Basic Size	Basic Size	Upper Tolerance (μm) +	Lower Tolerance (μm) +	Tolerance (μm)	Basic Size
M22×2	cutting tap	P2	22.000	20.701	40	20	20	19.835
		P4			80	60	20	
		P5			100	80	20	
		P6			120	100	20	
		ISO1			51	17	34	
		ISO2			85	51	34	
		ISO2X			110	76	34	
		ISO3			119	85	34	
		M22×1.5			cutting tap	P2	22.000	
P3	60		40	20				
P5	100		80	20				
ISO1	45		15	30				
ISO2	75		45	30				
ISO2X	100		70	30				
ISO3	105		75	30				
M22×1	cutting tap	P2	22.000	21.350	40	20	20	20.917
		P3			60	40	20	
		P4			80	60	20	
		ISO1			38	13	25	
		ISO2			63	38	25	
		ISO2X			83	58	25	
M24×3	cutting tap	P3	24.000	22.051	60	40	20	20.752
		P5			100	80	20	
		P6			120	100	20	
		P7			140	120	20	
		ISO1			64	21	43	
		ISO2			106	64	42	
		ISO2X			136	94	42	
		ISO3			148	106	42	
M24×2	cutting tap	P2	24.000	22.701	40	20	20	21.835
		P4			80	60	20	
		P5			100	80	20	
		P6			120	100	20	
		ISO1			54	18	36	
		ISO2			90	54	36	
		ISO2X			115	79	36	
		ISO3			126	90	36	
M24×1.5	cutting tap	P2	24.000	23.026	40	20	20	22.376
		P4			80	60	20	
		P5			100	80	20	
		P6			120	100	20	
		ISO1			48	16	32	
		ISO2			80	48	32	
		ISO2X			105	73	32	
		ISO3			112	80	32	
M24×1	cutting tap	P2	24.000	23.350	40	20	20	22.917
		P3			60	40	20	
		P4			80	60	20	
		ISO1			40	14	26	
		ISO2			66	40	26	
		ISO2X			86	60	26	
		ISO3			92	66	26	

Size	Kind of tap	Class	Major diameter		Pitch Diameter			Minor diameter
			Basic Size	Basic Size	Upper Tolerance (μm) +	Lower Tolerance (μm) +	Tolerance (μm)	Basic Size
M25×2	cutting tap	P2	25.000	23.701	40	20	20	22.835
		P4			80	60	20	
		P5			100	80	20	
		P6			120	100	20	
		ISO1			54	18	36	
		ISO2			90	54	36	
		ISO2X			115	79	36	
		ISO3			126	90	36	
		M25×1.5			cutting tap	P2	25.000	
P4	80		60	20				
P5	100		80	20				
P6	120		100	20				
ISO1	48		16	32				
ISO2	80		48	32				
ISO2X	105		73	32				
M25×1	cutting tap	P2	25.000	24.350	40	20	20	23.917
		P3			60	40	20	
		P4			80	60	20	
		ISO1			40	14	26	
		ISO2			66	40	26	
		ISO2X			86	60	26	
M26×2	cutting tap	P2	26.000	24.701	40	20	20	23.835
		P4			80	60	20	
		P5			100	80	20	
		P6			120	100	20	
		ISO1			54	18	36	
		ISO2			90	54	36	
		ISO2X			115	79	36	
		ISO3			126	90	36	
M26×1.5	cutting tap	P2	26.000	25.026	40	20	20	24.376
		P4			80	60	20	
		P5			100	80	20	
		P6			120	100	20	
		ISO1			48	16	32	
		ISO2			80	48	32	
		ISO2X			105	73	32	
		ISO3			112	80	32	
M26×1	cutting tap	P2	26.000	25.350	40	20	20	24.917
		P3			60	40	20	
		P4			80	60	20	
		ISO1			40	14	26	
		ISO2			66	40	26	
		ISO2X			86	60	26	
		ISO3			92	66	26	
M27×3	cutting tap	P3	27.000	25.051	60	20	40	23.752
		P5			100	60	40	
		P6			120	80	40	
		P7			140	100	40	
		ISO1			64	21	43	
		ISO2			106	64	42	
		ISO2X			136	94	42	
		ISO3			148	106	42	

SP
SL
PO
ST
ROLL
CARBIDE
LONG
HAND TAPS
EG (STI)
SPECIAL THREADS, GAUGES
THREAD MILLS
DIES
CENTER DRILLS

Technical info

10. Tap Thread Limits (JIS, DIN, ANSI)

Intro

Metric Threads (M, MF)

Unit: mm

SP	Size	Kind of tap	Class	Major diameter		Pitch Diameter			Minor diameter
				Basic Size	Basic Size	Upper Tolerance (µm) +	Lower Tolerance (µm) +	Tolerance (µm)	Basic Size
SL	M27×2	cutting tap	P2	27.000	25.701	40	20	20	24.835
			P4			80	60	20	
			P5			100	80	20	
			P6			120	100	20	
			ISO1			54	18	36	
			ISO2			90	54	36	
			ISO2X			115	79	36	
			ISO3			126	90	36	
PO	M27×1.5	cutting tap	P2	27.000	26.026	40	20	20	25.376
			P4			80	60	20	
			P5			100	80	20	
			P6			120	100	20	
			ISO1			48	16	32	
			ISO2			80	48	32	
			ISO2X			105	73	32	
			ISO3			112	80	32	
ST	M27×1	cutting tap	P2	27.000	26.350	40	20	20	25.917
			P3			60	40	20	
			P4			80	60	20	
			P6			120	100	20	
			ISO1			40	14	26	
			ISO2			66	40	26	
			ISO2X			86	60	26	
			ISO3			92	66	26	
ROLL	M28×2	cutting tap	P2	28.000	26.701	40	20	20	25.835
			P4			80	60	20	
			P5			100	80	20	
			P6			120	100	20	
			ISO1			54	18	36	
			ISO2			90	54	36	
			ISO2X			115	79	36	
			ISO3			126	90	36	
CARBIDE	M28×1.5	cutting tap	P2	28.000	27.026	40	20	20	26.376
			P4			80	60	20	
			P5			100	80	20	
			P6			120	100	20	
			ISO1			48	16	32	
			ISO2			80	48	32	
			ISO2X			105	73	32	
			ISO3			112	80	32	
LONG	M28×1	cutting tap	P2	28.000	27.350	40	20	20	26.917
			P3			60	40	20	
			P4			80	60	20	
			P6			120	100	20	
			ISO1			40	14	26	
			ISO2			66	40	26	
			ISO2X			86	60	26	
			ISO3			92	66	26	
HAND TAPS	M30×3	cutting tap	P3	30.000	28.051	60	20	40	26.752
			P5			100	60	40	
			P7			140	100	40	
			ISO1			64	21	43	
			ISO2			106	64	42	
			ISO2X			136	94	42	
			ISO3			148	106	42	
			EG (STI)			M30×2	cutting tap	P2	
P4	80	60		20					
P5	100	80		20					
P6	120	100		20					
ISO1	54	18		36					
ISO2	90	54		36					
ISO2X	115	79		36					
ISO3	126	90		36					
SPECIAL THREADS, GAUGES	M30×1.5	cutting tap	P2	30.000	29.026	40	20	20	28.376
			P4			80	60	20	
			P5			100	80	20	
			P6			120	100	20	
			ISO1			48	16	32	
			ISO2			80	48	32	
			ISO2X			105	73	32	
			ISO3			112	80	32	
THREAD MILLS	M30×1	cutting tap	P2	30.000	29.350	40	20	20	28.917
			P3			60	40	20	
			P4			80	60	20	
			P6			120	100	20	
			ISO1			40	14	26	
			ISO2			66	40	26	
			ISO2X			86	60	26	
			ISO3			92	66	26	
DIES	M32×2	cutting tap	P3	32.000	30.701	60	20	40	29.835
			P4			80	40	40	
			P6			120	80	40	
			ISO1			54	18	36	
			ISO2			90	54	36	
			ISO2X			115	79	36	
			ISO3			126	90	36	
			CENTER DRILLS			M32×1.5	cutting tap	P2	
P4	80	60		20					
P5	100	80		20					
P6	120	100		20					
ISO1	48	16		32					
ISO2	80	48		32					
ISO2X	105	73		32					
ISO3	112	80		32					
TECHNICAL INFO	M30×3.5	cutting tap	P3	30.000	27.727	60	20	40	26.211
			P6			120	80	40	
			P7			140	100	40	
			P8			160	120	40	
			ISO1			67	22	45	
			ISO2			112	67	45	
			ISO2X			142	97	45	
			ISO3			157	112	45	

SP	Size	Kind of tap	Class	Major diameter		Pitch Diameter			Minor diameter
				Basic Size	Basic Size	Upper Tolerance (µm) +	Lower Tolerance (µm) +	Tolerance (µm)	Basic Size
SL	M30×3	cutting tap	P3	30.000	28.051	60	20	40	26.752
			P5			100	60	40	
			P7			140	100	40	
			ISO1			64	21	43	
			ISO2			106	64	42	
			ISO2X			136	94	42	
			ISO3			148	106	42	
			PO			M30×2	cutting tap	P2	
P4	80	60		20					
P5	100	80		20					
P6	120	100		20					
ISO1	54	18		36					
ISO2	90	54		36					
ISO2X	115	79		36					
ISO3	126	90		36					
ST	M30×1.5	cutting tap	P2	30.000	29.026	40	20	20	28.376
			P4			80	60	20	
			P5			100	80	20	
			P6			120	100	20	
			ISO1			48	16	32	
			ISO2			80	48	32	
			ISO2X			105	73	32	
			ISO3			112	80	32	
ROLL	M30×1	cutting tap	P2	30.000	29.350	40	20	20	28.917
			P3			60	40	20	
			P4			80	60	20	
			P6			120	100	20	
			ISO1			40	14	26	
			ISO2			66	40	26	
			ISO2X			86	60	26	
			ISO3			92	66	26	
CARBIDE	M32×2	cutting tap	P3	32.000	30.701	60	20	40	29.835
			P4			80	40	40	
			P6			120	80	40	
			ISO1			54	18	36	
			ISO2			90	54	36	
			ISO2X			115	79	36	
			ISO3			126	90	36	
			LONG			M32×1.5	cutting tap	P2	
P4	80	60		20					
P5	100	80		20					
P6	120	100		20					
ISO1	48	16		32					
ISO2	80	48		32					
ISO2X	105	73		32					
ISO3	112	80		32					
HAND TAPS	M32×1	cutting tap	P2	32.000	31.350	40	20	20	30.917
			P3			60	40	20	
			P4			80	60	20	
			P6			120	100	20	
			ISO1			40	14	26	
			ISO2			66	40	26	
			ISO2X			86	60	26	
			ISO3			92	66	26	

Technical info

Metric Threads (M, MF)

Unit: mm

Size	Kind of tap	Class	Major diameter		Pitch Diameter			Minor diameter
			Basic Size	Basic Size	Upper Tolerance (μm) +	Lower Tolerance (μm) +	Tolerance (μm)	Basic Size
M33×3.5	cutting tap	P3	33.000	30.727	60	20	40	29.211
		P6			120	80	40	
		P7			140	100	40	
		P8			160	120	40	
		ISO1			67	22	45	
		ISO2			112	67	45	
		ISO2X			142	97	45	
		ISO3			157	112	45	
		M33×3			cutting tap	P3	33.000	
P5	100		60	40				
P7	140		100	40				
ISO1	64		21	43				
ISO2	106		64	42				
ISO2X	136		94	42				
M33×2	cutting tap	P3	33.000	31.701	60	20	40	30.835
		P4			80	40	40	
		P6			120	80	40	
		ISO1			54	18	36	
		ISO2			90	54	36	
		ISO2X			115	79	36	
M33×1.5	cutting tap	P2	33.000	32.026	40	20	20	31.376
		P4			80	60	20	
		P5			100	80	20	
		P6			120	100	20	
		ISO1			48	16	32	
		ISO2			80	48	32	
		ISO2X			105	73	32	
		ISO3			112	80	32	
		M33×1			cutting tap	P2	33.000	
P3	60		40	20				
P4	80		60	20				
ISO1	40		14	26				
ISO2	66		40	26				
ISO2X	86		60	26				
ISO3	92		66	26				
M35×1.5	cutting tap	P2	35.000	34.026	40	20	20	33.376
		P4			80	60	20	
		P5			100	80	20	
		P6			120	100	20	
		ISO1			48	16	32	
		ISO2			80	48	32	
		ISO2X			105	73	32	
		ISO3			112	80	32	
M35×1	cutting tap	P2	35.000	34.350	40	20	20	33.917
		P3			60	40	20	
		P4			80	60	20	
		ISO1			40	14	26	
		ISO2			66	40	26	
		ISO2X			86	60	26	
		ISO3			92	66	26	

Size	Kind of tap	Class	Major diameter		Pitch Diameter			Minor diameter
			Basic Size	Basic Size	Upper Tolerance (μm) +	Lower Tolerance (μm) +	Tolerance (μm)	Basic Size
M36×4	cutting tap	P3	36.000	33.402	60	20	40	31.670
		P6			120	80	40	
		P7			140	100	40	
		P8			160	120	40	
		ISO1			71	24	47	
		ISO2			118	71	47	
		ISO2X			148	101	47	
		ISO3			165	118	47	
		M36×3			cutting tap	P3	36.000	
P5	100		60	40				
P7	140		100	40				
ISO1	64		21	43				
ISO2	106		64	42				
ISO2X	136		94	42				
M36×2	cutting tap	P3	36.000	34.701	60	20	40	33.835
		P4			80	40	40	
		P6			120	80	40	
		ISO1			54	18	36	
		ISO2			90	54	36	
		ISO2X			115	79	36	
M36×1.5	cutting tap	P2	36.000	35.026	40	20	20	34.376
		P4			80	60	20	
		P5			100	80	20	
		P6			120	100	20	
		ISO1			48	16	32	
		ISO2			80	48	32	
		ISO2X			105	73	32	
		ISO3			112	80	32	
		M36×1			cutting tap	P2	36.000	
P3	60		40	20				
P4	80		60	20				
ISO1	40		14	26				
ISO2	66		40	26				
ISO2X	86		60	26				
ISO3	92		66	26				
M38×1.5	cutting tap	P2	38.000	37.026	40	20	20	36.376
		P4			80	60	20	
		P5			100	80	20	
		P6			120	100	20	
		ISO1			48	16	32	
		ISO2			80	48	32	
		ISO2X			105	73	32	
		ISO3			112	80	32	
M38×1	cutting tap	P2	38.000	37.350	40	20	20	36.917
		P3			60	40	20	
		P4			80	60	20	
		ISO1			40	14	26	
		ISO2			66	40	26	
		ISO2X			86	60	26	
		ISO3			92	66	26	

- SP
- SL
- PO
- ST
- ROLL
- CARBIDE
- LONG
- HAND TAPS
- EG (STI)
- SPECIAL THREADS, GAUGES
- THREAD MILLS
- DIES
- CENTER DRILLS

Technical info

10. Tap Thread Limits (JIS, DIN, ANSI)

Intro

Metric Threads (M, MF)

Unit: mm

SP	Size	Kind of tap	Class	Major diameter		Pitch Diameter			Minor diameter
				Basic Size	Basic Size	Upper Tolerance (μm) +	Lower Tolerance (μm) +	Tolerance (μm)	Basic Size
SL	M39×4	cutting tap	P3	39.000	36.402	60	20	40	34.670
			P6			120	80	40	
			P7			140	100	40	
			P8			160	120	40	
			ISO1			71	24	47	
			ISO2			118	71	47	
			ISO2X			148	101	47	
			ISO3			165	118	47	
ST	M39×3	cutting tap	P3	39.000	37.051	60	20	40	35.752
			P5			100	60	40	
			P7			140	100	40	
			ISO1			64	21	43	
			ISO2			106	64	42	
			ISO2X			136	94	42	
ROLL	M39×2	cutting tap	P3	39.000	37.701	60	20	40	36.835
			P4			80	40	40	
			P6			120	80	40	
			ISO1			54	18	36	
			ISO2			90	54	36	
			ISO2X			115	79	36	
HAND TAPS	M39×1.5	cutting tap	P2	39.000	38.026	40	20	20	37.376
			P4			80	60	20	
			P5			100	80	20	
			P6			120	100	20	
			ISO1			48	16	32	
			ISO2			80	48	32	
			ISO2X			105	73	32	
			ISO3			112	80	32	
EG (STI)	M39×1	cutting tap	P2	39.000	38.350	40	20	20	37.917
			P3			60	40	20	
			P4			80	60	20	
			ISO1			40	14	26	
			ISO2			66	40	26	
			ISO2X			86	60	26	
THREAD MILLS	M40×3	cutting tap	P3	40.000	38.051	60	20	40	36.752
			P5			100	60	40	
			P7			140	100	40	
			ISO1			64	21	43	
			ISO2			106	64	42	
			ISO2X			136	94	42	
DIES	M40×2	cutting tap	P3	40.000	38.701	60	20	40	37.835
			P4			80	40	40	
			P6			120	80	40	
			ISO1			54	18	36	
			ISO2			90	54	36	
			ISO2X			115	79	36	
CENTER DRILLS	M40×1	cutting tap	P3	40.000	38.701	60	20	40	37.835
			P4			80	40	40	
			P6			120	80	40	
			ISO1			54	18	36	
			ISO2			90	54	36	
			ISO2X			115	79	36	

SP	Size	Kind of tap	Class	Major diameter		Pitch Diameter			Minor diameter
				Basic Size	Basic Size	Upper Tolerance (μm) +	Lower Tolerance (μm) +	Tolerance (μm)	Basic Size
SL	M40×1.5	cutting tap	P2	40.000	39.026	40	20	20	38.376
			P4			80	60	20	
			P5			100	80	20	
			P6			120	100	20	
			ISO1			48	16	32	
			ISO2			80	48	32	
			ISO2X			105	73	32	
			ISO3			112	80	32	
ST	M42×4.5	cutting tap	P3	42.000	39.077	60	20	40	37.129
			P6			120	80	40	
			P7			140	100	40	
			P8			160	120	40	
			ISO1			75	25	50	
			ISO2			125	75	50	
ROLL	M42×4	cutting tap	P3	42.000	39.402	60	20	40	37.670
			P6			120	80	40	
			P7			140	100	40	
			P8			160	120	40	
			ISO1			71	24	47	
			ISO2			118	71	47	
HAND TAPS	M42×3	cutting tap	P3	42.000	40.051	60	20	40	38.752
			P5			100	60	40	
			P7			140	100	40	
			ISO1			64	21	43	
			ISO2			106	64	42	
			ISO2X			136	94	42	
EG (STI)	M42×2	cutting tap	P3	42.000	40.701	60	20	40	39.835
			P4			80	40	40	
			P6			120	80	40	
			ISO1			54	18	36	
			ISO2			90	54	36	
			ISO2X			115	79	36	
THREAD MILLS	M42×1.5	cutting tap	P2	42.000	41.026	40	20	20	40.376
			P4			80	60	20	
			P5			100	80	20	
			P6			120	100	20	
			ISO1			48	16	32	
			ISO2			80	48	32	
DIES	M42×1	cutting tap	P2	42.000	41.350	40	20	20	40.917
			P3			60	40	20	
			P4			80	60	20	
			ISO1			40	14	26	
			ISO2			66	40	26	
			ISO2X			86	60	26	
CENTER DRILLS	M42×1	cutting tap	P2	42.000	41.350	40	20	20	40.917
			P3			60	40	20	
			P4			80	60	20	
			ISO1			40	14	26	
			ISO2			66	40	26	
			ISO2X			86	60	26	

Technical info

Metric Threads (M, MF)

Unit: mm

Size	Kind of tap	Class	Major diameter		Pitch Diameter			Minor diameter					
			Basic Size	Basic Size	Upper Tolerance (μm) +	Lower Tolerance (μm) +	Tolerance (μm)	Basic Size					
M45×4.5	cutting tap	P3	45.000	42.077	60	20	40	40.129					
		P6			120	80	40						
		P7			140	100	40						
		P8			160	120	40						
		ISO1			75	25	50						
		ISO2			125	75	50						
		ISO2X			155	105	50						
		ISO3			175	125	50						
		M45×4			cutting tap	P3	45.000		42.402	60	20	40	40.670
P6	120		80	40									
P7	140		100	40									
P8	160		120	40									
ISO1	71		24	47									
ISO2	118		71	47									
ISO2X	148		101	47									
ISO3	165		118	47									
M45×3	cutting tap		P3	45.000		43.051		60		20	40	41.752	
		P5	100		60		40						
		P7	140		100		40						
		ISO1	64		21		43						
		ISO2	106		64		42						
		ISO2X	136		94		42						
		ISO3	148		106		42						
		M45×2	cutting tap		P3		45.000	43.701	60	20	40		42.835
					P4				80	40	40		
P6	120			80	40								
ISO1	54			18	36								
ISO2	90			54	36								
ISO2X	115			79	36								
ISO3	126			90	36								
M45×1.5	cutting tap			P2	45.000	44.026			40	20	20	43.376	
				P4					80	60	20		
		P5	100	80			20						
		P6	120	100			20						
		ISO1	48	16			32						
		ISO2	80	48			32						
		ISO2X	105	73			32						
		ISO3	112	80			32						
		M45×1	cutting tap	P2			45.000	44.350	40	20	20		43.917
P3	60			40	20								
P4	80			60	20								
ISO1	40			14	26								
ISO2	66			40	26								
ISO2X	86			60	26								
ISO3	92			66	26								
M48×5	cutting tap			P4	48.000	44.752			80	40	40	42.587	
				P6					120	80	40		
		P8	160	120			40						
		P9	180	140			40						
		ISO1	80	27			53						
		ISO2	133	80			53						
		ISO2X	163	110			53						
		ISO3	186	133			53						

Size	Kind of tap	Class	Major diameter		Pitch Diameter			Minor diameter					
			Basic Size	Basic Size	Upper Tolerance (μm) +	Lower Tolerance (μm) +	Tolerance (μm)	Basic Size					
M48×4	cutting tap	P3	48.000	45.402	60	20	40	43.670					
		P6			120	80	40						
		P7			140	100	40						
		P8			160	120	40						
		ISO1			71	24	47						
		ISO2			118	71	47						
		ISO2X			148	101	47						
		ISO3			165	118	47						
		M48×3			cutting tap	P3	48.000		46.051	60	20	40	44.752
P5	100		60	40									
P7	140		100	40									
ISO1	67		22	45									
ISO2	112		67	45									
ISO2X	142		97	45									
ISO3	157		112	45									
M48×2	cutting tap		P3	48.000		46.701		60		20	40	45.835	
			P5					100		60	40		
		P6	120		80		40						
		P7	140		100		40						
		ISO1	57		19		38						
		ISO2	95		57		38						
		ISO2X	120		82		38						
		ISO3	133		95		38						
		M48×1.5	cutting tap		P2		48.000	47.026	40	20	20		46.376
P4	80			60	20								
P5	100			80	20								
P6	120			100	20								
ISO1	48			16	32								
ISO2	80			48	32								
ISO2X	105			73	32								
ISO3	112			80	32								
M48×1	cutting tap			P2	48.000	47.350			40	20	20	46.917	
		P3	60	40			20						
		P4	80	60			20						
		P5	100	80			20						
		ISO1	45	15			30						
		ISO2	75	45			30						
		ISO2X	95	65			30						
		ISO3	105	75			30						

SP

SL

PO

ST

ROLL

CARBIDE

LONG

HAND TAPS

EG (STI)

SPECIAL THREADS, GAUGES

THREAD MILLS

DIES

CENTER DRILLS

Technical info

10. Tap Thread Limits (JIS, DIN, ANSI)

Intro

Unified Threads (UNC/UNF)

Unit: mm

SP	Size	Kind of tap	Class	Major diameter		Pitch Diameter			Minor diameter			
				Basic Size	Basic Size	Upper Tolerance (μm) +	Lower Tolerance (μm) +	Tolerance (μm)	Basic Size			
SL	No.0-80UNF	cutting tap	P1	1.524	1.318	25	10	15	1.181			
			3B			16	6	10				
			2B			26	11	15				
			GH1			12.7	0	12.7				
			GH2			25.4	12.7	12.7				
		forming tap	3BX	1.524	1.318	25	13	12	1.181			
			2BX			38	25	13				
			G3			38	25	13				
			G5			64	51	13				
			H2			25.4	12.7	12.7				
PO	No.1-64UNC	cutting tap	P1	1.854	1.598	25	10	15	1.425			
			3B			17	7	10				
			2B			28	12	16				
			GH1			12.7	0	12.7				
			GH2			25.4	12.7	12.7				
		forming tap	3BX	1.854	1.598	25	13	12	1.425			
			2BX			38	25	13				
			G3			38	25	13				
			G5			64	51	13				
			H2			25.4	12.7	12.7				
ST	No.1-72UNF	cutting tap	P1	1.854	1.626	25	10	15	1.473			
			3B			17	7	10				
			2B			28	12	16				
			GH1			12.7	0	12.7				
			GH2			25.4	12.7	12.7				
		forming tap	3BX	1.854	1.626	25	13	12	1.473			
			2BX			38	25	13				
			G3			38	25	13				
			G5			64	51	13				
			H2			25.4	12.7	12.7				
ROLL	No.2-56UNC	cutting tap	P1	2.184	1.890	25	10	15	1.694			
			3B			19	7	12				
			2B			30	13	17				
			GH1			12.7	0	12.7				
			GH2			25.4	12.7	12.7				
		forming tap	3BX	2.184	1.890	38	25	13	1.694			
			2BX			51	38	13				
			G4			51	38	13				
			G5			64	51	13				
			G7			89	76	13				
CARBIDE	No.2-64UNF	cutting tap	P1	2.184	1.928	25	10	15	1.755			
			3B			17	6	11				
			2B			29	12	17				
			GH1			12.7	0	13				
			GH2			25.4	12.7	13				
		forming tap	3BX	2.184	1.928	38	25	13	1.755			
			2BX			51	38	13				
			G4			51	38	13				
			H2			25.4	12.7	12.7				
			H3			38.1	25.4	12.7				
LONG	No.3-48UNC	cutting tap	P1	2.515	2.172	25	10	15	1.941			
			3B			20	8	12				
			2B	2.515	2.172	32	14	18				
			GH1			12.7	0	12.7				
			GH2			25.4	12.7	12.7				
		forming tap	3BX			38	25	13	1.941			
			2BX			51	38	13				
			G4	2.515	2.172	51	38	13				
			G5			64	51	13				
			H2			25.4	12.7	12.7				
HAND TAPS	No.3-56UNF	cutting tap	P1	2.515	2.220	25	10	15	2.024			
			3B			19	7	12				
			2B	2.515	2.220	31	13	18				
			GH1			12.7	0	12.7				
			GH2			25.4	12.7	12.7				
		forming tap	3BX			38	25	13	2.024			
			2BX			51	38	13				
			G4	2.515	2.220	51	38	13				
			H2			25.4	12.7	12.7				
			H3			38.1	25.4	12.7				
EG (STI)	No.4-40UNC	cutting tap	P1	2.845	2.433	25	10	15	2.156			
			P2			40	25	15				
			P3			55	40	15				
			3B			22	10	12				
			2B	2.845	2.433	34	16	18				
		forming tap	2BX			49	31	18				
			GH2			25.4	12.7	12.7				
			GH3			38.1	25.4	12.7				
			GH4			50.8	38.1	12.7				
			3BX			38	25	13	2.156			
SPECIAL THREADS, GAUGES	No.4-48UNF	forming tap	2BX			51	38	13				
			G4	2.845	2.433	51	38	13				
			G5			64	51	13				
			G6			76	64	12				
			G7			89	76	13				
		cutting tap	H3			38.1	25.4	12.7				
			H5			63.5	50.8	12.7				
			P1			25	10	15	2.271			
			3B			20	8	12				
			2B	2.845	2.502	32	14	18				
THREAD MILLS	No.4-48UNC	cutting tap	GH1			12.7	0	12.7				
			GH2			25.4	12.7	12.7				
			3BX			38	25	13	2.271			
			2BX			51	38	13				
			G4	2.845	2.502	51	38	13				
		forming tap	G5			64	51	13				
			H3			38.1	25.4	12.7				
			H5			63.5	50.8	12.7				
			DIES	No.2-64UNF	cutting tap	P1	2.184	1.928	25	10	15	1.755
			3B					17	6	11		
2B			29			12	17					
GH1			12.7			0	13					
GH2			25.4			12.7	13					
forming tap	3BX	2.184	1.928		38	25	13	1.755				
	2BX				51	38	13					
	G4				51	38	13					
	H2				25.4	12.7	12.7					
	H3				38.1	25.4	12.7					
CENTER DRILLS	No.2-64UNF	cutting tap	P1	2.184	1.928	25	10	15	1.755			
			3B			17	6	11				
			2B			29	12	17				
			GH1			12.7	0	13				
			GH2			25.4	12.7	13				
		forming tap	3BX	2.184	1.928	38	25	13	1.755			
			2BX			51	38	13				
			G4			51	38	13				
			H2			25.4	12.7	12.7				
			H3			38.1	25.4	12.7				

SP	Size	Kind of tap	Class	Major diameter		Pitch Diameter			Minor diameter			
				Basic Size	Basic Size	Upper Tolerance (μm) +	Lower Tolerance (μm) +	Tolerance (μm)	Basic Size			
SL	No.3-48UNC	cutting tap	P1			25	10	15				
			3B			20	8	12				
			2B	2.515	2.172	32	14	18	1.941			
			GH1			12.7	0	12.7				
			GH2			25.4	12.7	12.7				
		forming tap	3BX			38	25	13	1.941			
			2BX			51	38	13				
			G4	2.515	2.172	51	38	13				
			G5			64	51	13				
			H2			25.4	12.7	12.7				
PO	No.3-56UNF	cutting tap	P1			25	10	15				
			3B			19	7	12				
			2B	2.515	2.220	31	13	18	2.024			
			GH1			12.7	0	12.7				
			GH2			25.4	12.7	12.7				
		forming tap	3BX			38	25	13	2.024			
			2BX			51	38	13				
			G4	2.515	2.220	51	38	13				
			H2			25.4	12.7	12.7				
			H3			38.1	25.4	12.7				
ST	No.4-40UNC	cutting tap	P1			25	10	15				
			P2			40	25	15				
			P3			55	40	15				
			3B			22	10	12				
			2B	2.845	2.433	34	16	18	2.156			
		forming tap	2BX			49	31	18				
			GH2			25.4	12.7	12.7				
			GH3			38.1	25.4	12.7				
			GH4			50.8	38.1	12.7				
			3BX			38	25	13	2.156			
ROLL	No.4-48UNF	forming tap	2BX			51	38	13				
			G4	2.845	2.433	51	38	13				
			G5			64	51	13				
			G6			76	64	12				
			G7			89	76	13				
		cutting tap	H3			38.1	25.4	12.7				
			H5			63.5	50.8	12.7				
			P1			25	10	15	2.271			
			3B			20	8	12				
			2B	2.845	2.502	32	14	18				
HAND TAPS	No.4-48UNC	cutting tap	GH1			12.7	0	12.7				
			GH2			25.4	12.7	12.7				
			3BX			38	25	13	2.271			
			2BX			51	38	13				
			G4	2.845	2.502	51	38	13				
		forming tap	G5			64	51	13				
			H3			38.1	25.4	12.7				
			H5			63.5	50.8	12.7				
			DIES	No.2-64UNF	cutting tap	P1	2.184	1.928	25	10	15	1.755
			3B					17	6	11		
2B			29			12	17					
GH1			12.7			0	13					
GH2			25.4			12.7	13					
forming tap	3BX	2.184	1.928		38	25	13	1.755				
	2BX				51	38	13					
	G4				51	38	13					
	H2				25.4	12.7	12.7					
	H3				38.1	25.4	12.7					
CENTER DRILLS	No.2-64UNF	cutting tap	P1	2.184	1.928	25	10	15	1.755			
			3B			17	6	11				
			2B			29	12	17				
			GH1			12.7	0	13				
			GH2			25.4	12.7	13				
		forming tap	3BX	2.184	1.928	38	25	13	1.755			
			2BX			51	38	13				
			G4			51	38	13				
			H2			25.4						

Unified Threads (UNC/UNF)

Unit: mm

Size	Kind of tap	Class	Major diameter		Pitch Diameter			Minor diameter					
			Basic Size	Basic Size	Upper Tolerance (μm) +	Lower Tolerance (μm) +	Tolerance (μm)		Basic Size				
No.5-40UNC	cutting tap	P1	3.175	2.764	25	10	15	2.487					
		P2			40	25	15						
		3B			22	10	12						
		2B			35	16	19						
		GH2			25.4	12.7	12.7						
		GH3			38.1	25.4	12.7						
	forming tap	3BX	3.175	2.764	38	25	13	2.487					
		2BX			51	38	13						
		G4			51	38	13						
		G5			64	51	13						
		H3			38.1	25.4	12.7						
		H5			63.5	50.8	12.7						
No.5-44UNF	cutting tap	P1	3.175	2.799	25	10	15	2.550					
		P2			40	25	15						
		3B			21	9	12						
		2B			34	15	19						
		GH2			25.4	12.7	12.7						
		GH3			38.1	25.4	12.7						
	forming tap	3BX	3.175	2.799	38	25	13	2.550					
		2BX			51	38	13						
		G4			51	38	13						
		G5			64	51	13						
		H3			38.1	25.4	12.7						
		H5			63.5	50.8	12.7						
No.6-32UNC	cutting tap	P1	3.505	2.990	20	0	20	2.647					
		P2			40	20	20						
		P3			60	40	20						
		3B			25	11	14						
		2B			38	18	20						
		2BX			58	38	20						
		GH2			25.4	12.7	12.7						
		GH3			38.1	25.4	12.7						
		GH4			50.8	38.1	12.7						
	forming tap	3BX	3.505	2.990	51	38	13	2.647					
		2BX			64	51	13						
		G5			64	51	13						
		G6			76	64	12						
		G7			89	76	13						
		H3			38.1	25.4	12.7						
		H5			63.5	50.8	12.7						
		No.6-40UNF			cutting tap	P1	3.505		3.094	25	10	15	2.817
						P2				40	25	15	
P3	55		40	15									
3B	23		9	14									
2B	36		16	20									
2BX	51		31	20									
GH2	25.4		12.7	12.7									
GH3	38.1		25.4	12.7									
GH4	50.8		38.1	12.7									

Size	Kind of tap	Class	Major diameter		Pitch Diameter			Minor diameter
			Basic Size	Basic Size	Upper Tolerance (μm) +	Lower Tolerance (μm) +	Tolerance (μm)	
No.6-40UNF	forming tap	3BX	3.505	3.094	38	25	13	2.817
		2BX			64	51	13	
		G5			64	51	13	
		H3			38.1	25.4	12.7	
		H5			63.5	50.8	12.7	
No.8-32UNC	cutting tap	P1	4.166	3.650	20	0	20	3.307
		P2			40	20	20	
		P3			60	40	20	
		3B			25	11	14	
		2B			39	18	21	
		2BX			59	38	21	
		GH2			25.4	12.7	12.7	
		GH3			38.1	25.4	12.7	
		GH4			50.8	38.1	12.7	
	forming tap	3BX	4.166	3.650	51	38	13	3.307
		2BX			64	51	13	
		G5			64	51	13	
		G6			76	64	12	
		G7			89	76	13	
		H3			38.1	25.4	12.7	
No.8-36UNF	cutting tap	P1	4.166	3.708	20	0	20	3.401
		P2			40	20	20	
		P3			60	40	20	
		3B			24	10	14	
		2B			38	17	21	
		2BX			58	37	21	
		GH2			25.4	12.7	12.7	
		GH3			38.1	25.4	12.7	
		GH4			50.8	38.1	12.7	
	forming tap	3BX	4.166	3.708	51	38	13	3.401
		2BX			64	51	13	
		G5			64	51	13	
		H3			38.1	25.4	12.7	
		H5			63.5	50.8	12.7	
		No.10-24UNC			cutting tap	P1	4.826	
P2	40		20	20				
P3	60		40	20				
3B	27		13	14				
2B	42		20	22				
2BX	62		40	22				
GH2	25.4		12.7	12.7				
GH3	38.1		25.4	12.7				
GH4	50.8		38.1	12.7				
forming tap	3BX		4.826	4.138	51	38	13	3.680
	2BX				76	64	12	
	G6				76	64	12	
	G7				89	76	13	
	H4				50.8	38.1	12.7	
	H6				76.2	63.5	12.7	

- SP
- SL
- PO
- ST
- ROLL
- CARBIDE
- LONG
- HAND TAPS
- EG (STI)
- SPECIAL THREADS, GAUGES
- THREAD MILLS
- DIES
- CENTER DRILLS

Technical info

10. Tap Thread Limits (JIS, DIN, ANSI)

Intro

Unified Threads (UNC/UNF)

Unit: mm

SP	Size	Kind of tap	Class	Major diameter		Pitch Diameter			Minor diameter		
				Basic Size	Basic Size	Upper Tolerance (μm) +	Lower Tolerance (μm) +	Tolerance (μm)	Basic Size		
SL	No.10-32UNF	cutting tap	P1	4.826	4.310	20	0	20	3.967		
			P2			40	20	20			
			P3			60	40	20			
			3B			25	11	14			
			2B			40	18	22			
			2BX			60	38	22			
			GH2			25.4	12.7	12.7			
			GH3			38.1	25.4	12.7			
ST	No.10-32UNF	forming tap	3BX	4.826	4.310	51	38	13	3.967		
			2BX			64	51	13			
			G5			64	51	13			
			G6			76	64	12			
			G7			89	76	13			
			H4			50.8	38.1	12.7			
ROLL	No.10-32UNF	forming tap	H6	4.826	4.310	76.2	63.5	12.7	3.967		
			H4			50.8	38.1	12.7			
			H6			76.2	63.5	12.7			
			H4			50.8	38.1	12.7			
CARBIDE	No.12-24UNC	cutting tap	P1	5.486	4.798	20	0	20	4.341		
			P2			40	20	20			
			P3			60	40	20			
			3B			28	12	16			
			2B			43	20	23			
			2BX			63	40	23			
		LONG	No.12-24UNC	cutting tap	GH2	5.486	4.798	25.4	12.7	12.7	4.341
					GH3			38.1	25.4	12.7	
					GH4			50.8	38.1	12.7	
					GH5			63.5	50.8	12.7	
					GH2			25.4	12.7	12.7	
					GH3			38.1	25.4	12.7	
HAND TAPS	No.12-24UNC	forming tap	3BX	5.486	4.798	51	38	13	4.341		
			2BX			76	64	12			
			G6			76	64	12			
			H4			50.8	38.1	12.7			
			H6			76.2	63.5	12.7			
			H4			50.8	38.1	12.7			
EG (STI)	No.12-28UNF	cutting tap	P1	5.486	4.897	20	0	20	4.503		
			P2			40	20	20			
			P3			60	40	20			
			3B			27	11	16			
			2B			42	19	23			
			2BX			62	39	23			
		SPECIAL THREADS, GAUGES	No.12-28UNF	cutting tap	GH2	5.486	4.897	25.4	12.7	12.7	4.503
					GH3			38.1	25.4	12.7	
					GH4			50.8	38.1	12.7	
					GH5			63.5	50.8	12.7	
					GH2			25.4	12.7	12.7	
					GH3			38.1	25.4	12.7	
THREAD MILLS	No.12-28UNF	forming tap	3BX	5.486	4.897	51	38	13	4.503		
			2BX			76	64	12			
			G6			76	64	12			
			H4			50.8	38.1	12.7			
			H6			76.2	63.5	12.7			
			H4			50.8	38.1	12.7			
DIES	No.12-28UNF	forming tap	H6	5.486	4.897	76.2	63.5	12.7	4.503		
			H4			50.8	38.1	12.7			
			H6			76.2	63.5	12.7			
			H4			50.8	38.1	12.7			
			H6			76.2	63.5	12.7			
			H4			50.8	38.1	12.7			

SP	Size	Kind of tap	Class	Major diameter		Pitch Diameter			Minor diameter		
				Basic Size	Basic Size	Upper Tolerance (μm) +	Lower Tolerance (μm) +	Tolerance (μm)	Basic Size		
SL	1/4-20UNC	cutting tap	P1	6.350	5.524	20	0	20	4.976		
			P2			40	20	20			
			P3			60	40	20			
			3B			30	14	16			
			2B			46	22	24			
			2BX			71	47	24			
			GH2			25.4	12.7	12.7			
			GH3			38.1	25.4	12.7			
ST	1/4-20UNC	forming tap	3BX	6.350	5.524	64	51	13	4.976		
			2BX			76	64	12			
			G6			76	64	12			
			G7			89	76	13			
			H4			50.8	38.1	12.7			
			H6			76.2	63.5	12.7			
CARBIDE	1/4-28UNF	cutting tap	P1	6.350	5.761	20	0	20	5.367		
			P2			40	20	20			
			P3			60	40	20			
			3B			27	11	16			
			2B			43	19	24			
			2BX			63	39	24			
		LONG	1/4-28UNF	cutting tap	GH2	6.350	5.761	25.4	12.7	12.7	5.367
					GH3			38.1	25.4	12.7	
					GH4			50.8	38.1	12.7	
					GH5			63.5	50.8	12.7	
					GH2			25.4	12.7	12.7	
					GH3			38.1	25.4	12.7	
HAND TAPS	1/4-28UNF	forming tap	3BX	6.350	5.761	51	38	13	5.367		
			2BX			76	64	12			
			G6			76	64	12			
			G7			89	76	13			
			H4			50.8	38.1	12.7			
			H6			76.2	63.5	12.7			
EG (STI)	5/16-18UNC	cutting tap	P2	7.938	7.021	40	20	20	6.411		
			P3			60	40	20			
			3B			32	14	18			
			2B			49	23	26			
			2BX			74	48	26			
			GH2			25.4	12.7	12.7			
		SPECIAL THREADS, GAUGES	5/16-18UNC	cutting tap	GH3	7.938	7.021	38.1	25.4	12.7	6.411
					GH5			63.5	50.8	12.7	
					GH2			25.4	12.7	12.7	
					GH3			38.1	25.4	12.7	
					GH5			63.5	50.8	12.7	
					GH2			25.4	12.7	12.7	
THREAD MILLS	5/16-18UNC	forming tap	3BX	7.938	7.021	64	51	13	6.411		
			2BX			89	76	13			
			G7			89	76	13			
			H5			63.5	50.8	12.7			
			H7			88.9	76.2	12.7			
			H5			63.5	50.8	12.7			

CENTER DRILLS

Technical info

Unified Threads (UNC/UNF)

Unit: mm

Size	Kind of tap	Class	Major diameter		Pitch Diameter			Minor diameter
			Basic Size	Basic Size	Upper Tolerance (μm) +	Lower Tolerance (μm) +	Tolerance (μm)	Basic Size
5/16-24UNF	cutting tap	P1	7.938	7.249	20	0	20	6.792
		P2			40	20	20	
		P3			60	40	20	
		3B			29	11	18	
		2B			46	20	26	
		2BX			66	40	26	
		GH2			25.4	12.7	12.7	
		GH3			38.1	25.4	12.7	
		GH4			50.8	38.1	12.7	
		GH5			63.5	50.8	12.7	
	forming tap	3BX	7.938	7.249	64	51	13	6.792
		2BX			76	64	12	
		G6			76	64	12	
		H5			63.5	50.8	12.7	
H7		88.9			76.2	12.7		
3/8-16UNC	cutting tap	P2	9.525	8.494	40	20	20	7.805
		P3			60	40	20	
		P4			80	60	20	
		3B			34	16	18	
		2B			53	25	28	
		2BX			78	50	28	
		GH3			38.1	25.4	12.7	
		GH4			50.8	38.1	12.7	
		GH5			63.5	50.8	12.7	
		GH6			76.2	63.5	12.7	
	forming tap	3BX	9.525	8.494	76	64	12	7.805
		2BX			102	89	13	
		G8			102	89	13	
		H5			63.5	50.8	12.7	
H7	88.9	76.2	12.7					
3/8-24UNF	cutting tap	P1	9.525	8.837	20	0	20	8.379
		P2			40	20	20	
		P3			60	40	20	
		3B			29	11	18	
		2B			48	20	28	
		2BX			68	40	28	
		GH2			25.4	12.7	12.7	
		GH3			38.1	25.4	12.7	
		GH4			50.8	38.1	12.7	
		GH5			63.5	50.8	12.7	
	forming tap	3BX	9.525	8.837	64	51	13	8.379
		2BX			89	76	13	
		G7			89	76	13	
		H5			63.5	50.8	12.7	
H7	88.9	76.2	12.7					

Size	Kind of tap	Class	Major diameter		Pitch Diameter			Minor diameter
			Basic Size	Basic Size	Upper Tolerance (μm) +	Lower Tolerance (μm) +	Tolerance (μm)	Basic Size
7/16-14UNC	cutting tap	P2	11.112	9.934	40	20	20	9.149
		P3			60	40	20	
		P4			80	60	20	
		3B			37	17	20	
		2B			56	27	29	
		2BX			81	52	29	
		GH3			38.1	25.4	12.7	
		GH4			50.8	38.1	12.7	
		GH5			63.5	50.8	12.7	
		GH6			76.2	63.5	12.7	
	forming tap	3BX	11.112	9.934	76	64	12	9.149
		2BX			102	89	13	
G8		102			89	13		
H5		63.5			50.8	12.7		
H7	88.9	76.2	12.7					
7/16-20UNF	cutting tap	P1	11.112	10.287	20	0	20	9.738
		P2			40	20	20	
		P3			60	40	20	
		P4			80	60	20	
		3B			32	12	20	
		2B			51	22	29	
		2BX			76	47	29	
		GH2			25.4	12.7	12.7	
		GH3			38.1	25.4	12.7	
		GH4			50.8	38.1	12.7	
	GH5	63.5	50.8	12.7				
	GH6	76.2	63.5	12.7				
	forming tap	3BX	11.112	10.287	76	64	12	9.738
		2BX			89	76	13	
G7		89			76	13		
H5		63.5			50.8	12.7		
H7	88.9	76.2	12.7					
1/2-13UNC	cutting tap	P2	12.700	11.430	40	20	20	10.584
		P3			60	40	20	
		P4			80	60	20	
		3B			38	18	20	
		2B			58	28	30	
		2BX			83	53	30	
		GH3			38.1	25.4	12.7	
		GH4			50.8	38.1	12.7	
		GH5			63.5	50.8	12.7	
		GH6			76.2	63.5	12.7	
	forming tap	3BX	12.700	11.430	76	64	12	10.584
		2BX			114	102	12	
		G9			114	102	12	
		H5			63.5	50.8	12.7	
H7	88.9	76.2	12.7					

SP

SL

PO

ST

ROLL

CARBIDE

LONG

HAND TAPS

EG (STI)

SPECIAL THREADS, GAUGES

THREAD MILLS

DIES

CENTER DRILLS

Technical info

10. Tap Thread Limits (JIS, DIN, ANSI)

Intro

Unified Threads (UNC/UNF)

Unit: mm

SP	Size	Kind of tap	Class	Major diameter		Pitch Diameter			Minor diameter
				Basic Size	Basic Size	Upper Tolerance (µm) +	Lower Tolerance (µm) +	Tolerance (µm)	
SL	1/2-20UNF	cutting tap	P1	12.700	11.874	20	0	20	11.326
			P2			40	20	20	
			P3			60	40	20	
			P4			80	60	20	
			3B			32	12	20	
			2B			52	22	30	
			2BX			77	47	30	
			GH2			25.4	12.7	12.7	
			GH3			38.1	25.4	12.7	
			GH4			50.8	38.1	12.7	
ST	1/2-20UNF	cutting tap	GH5	12.700	11.874	63.5	50.8	12.7	11.326
			GH6			76.2	63.5	12.7	
			3BX			76	64	12	
			2BX			89	76	13	
			G7			89	76	13	
			H5			63.5	50.8	12.7	
ROLL	1/2-20UNF	forming tap	H7	12.700	11.874	88.9	76.2	12.7	11.326
			H5			63.5	50.8	12.7	
			G7			89	76	13	
			2BX			89	76	13	
CARBIDE	9/16-12UNC	cutting tap	P2	14.288	12.913	40	20	20	11.996
			P3			60	40	20	
			P4			80	60	20	
			3B			39	19	20	
			2B			60	29	31	
			2BX			85	54	31	
			GH3			38.1	25.4	12.7	
			GH4			50.8	38.1	12.7	
			GH6			76.2	63.5	12.7	
			LONG			9/16-12UNC	cutting tap	GH6	
GH4	50.8	38.1		12.7					
GH3	38.1	25.4		12.7					
2BX	85	54		31					
2B	60	29		31					
3B	39	19		20					
P4	80	60		20					
P3	60	40		20					
P2	40	20		20					
HAND TAPS	9/16-18UNF	cutting tap		P1	14.288			13.371	20
			P2	40		20	20		
			P3	60		40	20		
			P4	80		60	20		
			3B	33		13	20		
			2B	55		23	32		
			2BX	80		48	32		
			GH2	25.4		12.7	12.7		
			GH3	38.1		25.4	12.7		
			GH4	50.8		38.1	12.7		
EG (STI)	9/16-18UNF	cutting tap	GH5	14.288	13.371	63.5	50.8	12.7	12.761
			GH6			76.2	63.5	12.7	
			GH4			50.8	38.1	12.7	
			GH3			38.1	25.4	12.7	
			2BX			80	48	32	
			2B			55	23	32	
SPECIAL THREADS, GAUGES	9/16-18UNF	cutting tap	3B	14.288	13.371	33	13	20	12.761
			P4			80	60	20	
			P3			60	40	20	
			P2			40	20	20	
			P1			20	0	20	
			P1			20	0	20	
THREAD MILLS	5/8-11UNC	cutting tap	P2	15.875	14.376	40	20	20	13.376
			P3			60	40	20	
			P4			80	60	20	
			3B			41	19	22	
			2B			63	30	33	
			2BX			88	55	33	
			GH3			38.1	25.4	12.7	
DIES	5/8-11UNC	cutting tap	GH4	15.875	14.376	50.8	38.1	12.7	13.376
			GH5			63.5	50.8	12.7	
			GH6			76.2	63.5	12.7	
			GH7			88.9	76.2	12.7	
			GH6			76.2	63.5	12.7	
CENTER DRILLS	5/8-11UNC	cutting tap	GH7	15.875	14.376	88.9	76.2	12.7	13.376
			GH6			76.2	63.5	12.7	
			GH5			63.5	50.8	12.7	
			GH4			50.8	38.1	12.7	
			GH3			38.1	25.4	12.7	
			2BX			88	55	33	
			2B			63	30	33	

SP	Size	Kind of tap	Class	Major diameter		Pitch Diameter			Minor diameter
				Basic Size	Basic Size	Upper Tolerance (µm) +	Lower Tolerance (µm) +	Tolerance (µm)	
SL	5/8-18UNF	cutting tap	P1	15.875	14.958	20	0	20	14.348
			P2			40	20	20	
			P3			60	40	20	
			P4			80	60	20	
			3B			34	12	22	
			2B			56	23	33	
			2BX			81	48	33	
			GH2			25.4	12.7	12.7	
			GH3			38.1	25.4	12.7	
			GH4			50.8	38.1	12.7	
ST	5/8-18UNF	cutting tap	GH5	15.875	14.958	63.5	50.8	12.7	14.348
			GH6			76.2	63.5	12.7	
			3B			34	12	22	
			2B			56	23	33	
			2BX			81	48	33	
			GH2			25.4	12.7	12.7	
ROLL	3/4-10UNC	cutting tap	P2	19.050	17.399	40	20	20	16.299
			P3			60	40	20	
			P4			80	60	20	
			3B			43	19	24	
			2B			66	31	35	
			2BX			91	56	35	
			GH3			38.1	25.4	12.7	
			GH4			50.8	38.1	12.7	
			GH5			63.5	50.8	12.7	
			GH6			76.2	63.5	12.7	
CARBIDE	3/4-10UNC	cutting tap	GH7	19.050	17.399	88.9	76.2	12.7	16.299
			GH6			76.2	63.5	12.7	
			GH5			63.5	50.8	12.7	
			GH4			50.8	38.1	12.7	
			GH3			38.1	25.4	12.7	
			2BX			91	56	35	
			2B			66	31	35	
LONG	3/4-16UNF	cutting tap	P2	19.050	18.019	40	20	20	17.330
			P3			60	40	20	
			P4			80	60	20	
			3B			35	13	22	
			2B			60	25	35	
			2BX			85	50	35	
			GH3			38.1	25.4	12.7	
			GH4			50.8	38.1	12.7	
			GH5			63.5	50.8	12.7	
			GH6			76.2	63.5	12.7	
HAND TAPS	3/4-16UNF	cutting tap	GH6	19.050	18.019	76.2	63.5	12.7	17.330
			GH5			63.5	50.8	12.7	
			GH4			50.8	38.1	12.7	
			GH3			38.1	25.4	12.7	
			2BX			85	50	35	
			2B			60	25	35	
			3B			35	13	22	
EG (STI)	3/4-16UNF	cutting tap	P3	19.050	18.019	60	40	20	17.330
			P4			80	60	20	
			P2			40	20	20	
			3B			35	13	22	
			2B			60	25	35	
			2BX			85	50	35	
			GH3			38.1	25.4	12.7	
			GH4			50.8	38.1	12.7	
			GH5			63.5	50.8	12.7	
			GH6			76.2	63.5	12.7	
SPECIAL THREADS, GAUGES	3/4-16UNF	cutting tap	GH6	19.050	18.019	76.2	63.5	12.7	17.330
			GH5			63.5	50.8	12.7	
			GH4			50.8	38.1	12.7	
			GH3			38.1	25.4	12.7	
			2BX			85	50	35	
			2B			60	25	35	
			3B			35	13	22	
THREAD MILLS	7/8-9UNC	cutting tap	P2	22.225	20.391	40	20	20	19.169
			P3			60	40	20	
			P4			80	60	20	
			3B			45	21	24	
			2B			70	33	37	
			2BX			95	58	37	
			GH3			38.1	25.4	12.7	
DIES	7/8-9UNC	cutting tap	GH4	22.225	20.391	50.8	38.1	12.7	19.169
			GH5			63.5	50.8	12.7	
			GH6			76.2	63.5	12.7	
			GH7			88.9	76.2	12.7	
			GH6			76.2	63.5	12.7	
			GH5			63.5	50.8	12.7	
			GH4			50.8	38.1	12.7	
CENTER DRILLS	7/8-14UNF	cutting tap	P2	22.225	21.046	40	20	20	20.262
			P3			60	40	20	
			P4			80	60	20	
			3B			39	15	24	
			2B			64	27	37	
			2BX			89	52	37	
			GH3			38.1	25.4	12.7	
			GH4			50.8	38.1	12.7	
			GH5			63.5	50.8	12.7	
			GH6			76.2	63.5	12.7	
SPECIAL THREADS, GAUGES	7/8-14UNF	cutting tap	GH7	22.225	21.046	88.9	76.2	12.7	20.262
			GH6			76.2	63.5	12.7	
			GH5			63.5	50.8	12.7	
			GH4			50.8	38.1	12.7	

Technical info

Unified Threads (UNC/UNF)

Unit: mm

Size	Kind of tap	Class	Major diameter		Pitch Diameter			Minor diameter
			Basic Size	Basic Size	Upper Tolerance (μm) +	Lower Tolerance (μm) +	Tolerance (μm)	Basic Size
1-8UNC	cutting tap	P2	25.400	23.338	40	0	40	21.963
		P3			60	20	40	
		P5			100	60	40	
		3B			48	22	26	
		2B			73	35	38	
		2BX			103	65	38	
		GH3			38.1	25.4	12.7	
		GH4			50.8	38.1	12.7	
		GH5			63.5	50.8	12.7	
		GH7			88.9	76.2	12.7	
		GH8			101.6	88.9	12.7	
1-12UNF	cutting tap	P2	25.400	24.026	40	20	20	23.109
		P3			60	40	20	
		P4			80	60	20	
		3B			42	16	26	
		2B			67	29	38	
		2BX			92	54	38	
		GH3			38.1	25.4	12.7	
		GH4			50.8	38.1	12.7	
		GH5			63.5	50.8	12.7	
		GH6			76.2	63.5	12.7	
		GH7			88.9	76.2	12.7	
1-1/8-7UNC	cutting tap	P3	28.575	26.218	60	20	40	24.648
		P4			80	40	40	
		P5			100	60	40	
		3B			51	25	26	
		2B			78	38	40	
		2BX			108	68	40	
		GH4			50.8	25.4	25.4	
		GH6			76.2	50.8	25.4	
		GH8			101.6	76.2	25.4	
1-1/8-12UNF	cutting tap	P2	28.575	27.201	40	20	20	26.284
		P3			60	40	20	
		P4			80	60	20	
		3B			42	15	27	
		2B			69	29	40	
		2BX			94	54	40	
		GH3			38.1	12.7	25.4	
		GH5			63.5	38.1	25.4	
		GH7			88.9	63.5	25.4	
1-1/4-7UNC	cutting tap	P3	31.750	29.393	60	20	40	27.823
		P4			80	40	40	
		P5			100	60	40	
		3B			52	24	28	
		2B			79	38	41	
		2BX			109	68	41	
		GH4			50.8	25.4	25.4	
		GH6			76.2	50.8	25.4	
		GH8			101.6	76.2	25.4	

Size	Kind of tap	Class	Major diameter		Pitch Diameter			Minor diameter
			Basic Size	Basic Size	Upper Tolerance (μm) +	Lower Tolerance (μm) +	Tolerance (μm)	Basic Size
1-1/4-12UNF	cutting tap	P2	31.750	30.376	40	20	20	29.459
		P3			60	40	20	
		P4			80	60	20	
		3B			43	15	28	
		2B			70	29	41	
		2BX			95	54	41	
		GH3			38.1	12.7	25.4	
		GH5			63.5	38.1	25.4	
		GH7			88.9	63.5	25.4	
1-3/8-6UNC	cutting tap	P3	34.925	32.174	60	20	40	30.343
		P4			80	40	40	
		P5			100	60	40	
		3B			55	27	28	
		2B			83	41	42	
		2BX			113	71	42	
		GH4			50.8	25.4	25.4	
		GH6			76.2	50.8	25.4	
		GH8			101.6	76.2	25.4	
GH9	114.3	88.9	25.4					
1-3/8-12UNF	cutting tap	P3	34.925	33.551	60	20	40	32.634
		P4			80	40	40	
		P5			100	60	40	
		3B			43	15	28	
		2B			71	29	42	
		2BX			96	54	42	
		GH3			38.1	12.7	25.4	
GH5	63.5	38.1	25.4					
GH7	88.9	63.5	25.4					
1-1/2-6UNC	cutting tap	P3	38.100	35.349	60	20	40	33.518
		P4			80	40	40	
		P6			120	80	40	
		3B			56	26	30	
		2B			85	41	44	
		2BX			115	71	44	
		GH4			50.8	25.4	25.4	
		GH6			76.2	50.8	25.4	
		GH8			101.6	76.2	25.4	
GH9	114.3	88.9	25.4					
1-1/2-12UNF	cutting tap	P3	38.100	36.726	60	20	40	35.809
		P4			80	40	40	
		P5			100	60	40	
		3B			44	14	30	
		2B			73	29	44	
		2BX			98	54	44	
		GH3			38.1	12.7	25.4	
		GH5			63.5	38.1	25.4	
GH7	88.9	63.5	25.4					

SP

SL

PO

ST

ROLL

CARBIDE

LONG

HAND TAPS

EG (STI)

SPECIAL THREADS, GAUGES

THREAD MILLS

DIES

CENTER DRILLS

Technical info

10. Tap Thread Limits (JIS, DIN, ANSI)

Intro

Whitworth Threads (BSW)

Unit: mm

Size	Class	Major diameter	Pitch Diameter				Minor diameter
		Basic Size	Basic Size	Upper Tolerance (μm) +	Lower Tolerance (μm) +	Basic Size	
1/8 W 40	P1	3.175	2.768	25	10	2.362	
5/32 W 32	P2	3.969	3.460	40	20	2.952	
3/16 W 24	P2	4.762	4.085	40	20	3.407	
7/32 W 24	P2	5.556	4.879	40	20	4.201	
1/4 W 20	P2	6.350	5.537	40	20	4.724	
5/16 W 18	P2	7.938	7.034	40	20	6.130	
3/8 W 16	P2	9.525	8.509	40	20	7.493	
7/16 W 14	P3	11.112	9.950	60	40	8.788	
1/2 W 12	P3	12.700	11.345	60	40	9.990	
9/16 W 12	P3	14.288	12.933	60	40	11.578	
5/8 W 11	P3	15.875	14.396	60	40	12.917	
3/4 W 10	P3	19.050	17.424	60	40	15.798	
7/8 W 9	P3	22.225	20.418	60	40	18.611	
1 W 8	P3	25.400	23.367	60	20	21.334	
1 1/8 W 7	P4	28.575	26.252	80	40	23.929	
1 1/4 W 7	P4	31.750	29.427	80	40	27.104	
1 3/8 W 6	P4	34.925	32.214	80	40	29.503	
1 1/2 W 6	P4	38.100	35.389	80	40	32.678	
1 5/8 W 5	P4	41.275	38.022	80	40	34.769	
1 3/4 W 5	P4	44.450	41.197	80	40	37.944	
1 7/8 W 4.5	P4	47.625	44.011	80	40	40.397	
2 W 4.5	P4	50.800	47.186	80	40	43.572	

SP

SL

PO

ST

ROLL

CARBIDE

LONG

HAND TAPS

EG (STI)

SPECIAL THREADS, GAUGES

THREAD MILLS

DIES

CENTER DRILLS

Technical info

Parallel Pipe Threads G(BSP)

Unit: mm

Size	Class	Major diameter	Pitch Diameter				Minor diameter
		Basic Size	Basic Size	Upper Tolerance (μm) +	Lower Tolerance (μm) +	Basic Size	
G 1/8 - 28	-	9.728	9.147	43	21	8.566	
G 1/4 - 19	-	13.157	12.301	50	25	11.445	
G 3/8 - 19	-	16.662	15.806	50	25	14.950	
G 1/2 - 14	-	20.955	19.793	57	28	18.631	
G 5/8 - 14	-	22.911	21.749	57	28	20.587	
G 3/4 - 14	-	26.441	25.279	57	28	24.117	
G 7/8 - 14	-	30.201	29.039	57	28	27.877	
G 1 - 11	-	33.249	31.770	72	36	30.291	
G 1 1/4 - 11	-	41.910	40.431	72	36	38.952	
G 1 1/2 - 11	-	47.803	46.324	72	36	44.845	

Parallel Pipe Threads PF(G)

Unit: mm

Size	Class	Major diameter	Pitch Diameter				Minor diameter
		Basic Size	Basic Size	Upper Tolerance (μm) +	Lower Tolerance (μm) +	Basic Size	
PF 1/16 - 28	II	7.723	7.142	40	20	6.561	
PF 1/8 - 28	II	9.728	9.147	40	20	8.566	
PF 1/4 - 19	II	13.157	12.301	50	25	11.445	
PF 3/8 - 19	II	16.662	15.806	50	25	14.950	
PF 1/2 - 14	II	20.955	19.793	55	25	18.631	
PF 5/8 - 14	II	22.911	21.749	55	25	20.587	
PF 3/4 - 14	II	26.441	25.279	55	25	24.117	
PF 7/8 - 14	II	30.201	29.039	55	25	27.877	
PF 1 - 11	II	33.249	31.770	60	30	30.291	
PF 1 1/4 - 11	II	41.910	40.431	65	30	38.952	
PF 1 1/2 - 11	II	47.803	46.324	65	30	44.845	
PF 2 - 11	II	59.614	58.135	75	35	56.656	
PF 2 1/2 - 11	II	75.184	73.705	80	40	72.226	
PF 3 - 11	II	87.884	86.405	85	40	84.926	
PF 3 1/2 - 11	II	100.330	98.851	85	40	97.372	
PF 4 - 11	II	113.030	111.551	85	40	110.072	

Parallel Internal Pipe Threads Rp(BSPP)-PS

Unit: mm

Size	Class	Major diameter	Pitch Diameter				Minor diameter
		Basic Size	Basic Size	Upper Tolerance (μm) +	Lower Tolerance (μm) +	Basic Size	
PS 1/16 - 28	II	7.723	7.142	30	50	6.561	
PS 1/8 - 28	II	9.728	9.147	30	50	8.566	
PS 1/4 - 19	II	13.157	12.301	50	75	11.445	
PS 3/8 - 19	II	16.662	15.806	50	75	14.950	
PS 1/2 - 14	II	20.955	19.793	85	115	18.631	
PS 5/8 - 14	II	22.911	21.749	85	115	20.587	
PS 3/4 - 14	II	26.441	25.279	85	115	24.117	
PS 7/8 - 14	II	30.201	29.039	85	115	27.877	
PS 1 - 11	II	33.249	31.770	120	150	30.291	
PS 1 1/4 - 11	II	41.910	40.431	115	150	38.952	
PS 1 1/2 - 11	II	47.803	46.324	115	150	44.845	
PS 2 - 11	II	59.614	58.135	105	145	56.656	
PS 2 1/2 - 11	II	75.184	73.705	140	180	72.226	
PS 3 - 11	II	87.884	86.405	135	180	84.926	
PS 4 - 11	II	113.030	111.551	135	180	110.072	

Helical Coil Wire Thread Inserts,
Metric Threads EG(STI)M-MF

Unit: mm

Size	Class	Major diameter		Pitch Diameter		Minor diameter	
		Basic Size	Basic Size	Upper Tolerance (µm) +	Lower Tolerance (µm) +	Basic Size	Basic Size
STI M 2.6 x 0.45	lb	3.185	2.892	18	6	2.698	
STI M 3 x 0.5	lb	3.650	3.324	18	6	3.108	
	G3			38	25		
STI M 4 x 0.7	lb	4.909	4.454	18	6	4.151	
	G4			51	38		
STI M 5 x 0.8	lb	6.039	5.519	18	6	5.173	
	G4			51	38		
STI M 6 x 1	lb	7.299	6.649	18	6	6.216	
	G4			51	38		
STI M 8 x 1.25	lb	9.624	8.812	18	6	8.271	
	G4			51	38		
STI M 10 x 1.5	lb	11.948	10.974	22	7	10.324	
	G5			64	51		
STI MF 10 x 1.25	lb	11.624	10.812	18	6	10.271	
STI MF 10 x 1	lb	11.299	10.649	18	6	10.216	
STI M 12 x 1.75	lb	14.273	13.136	22	7	12.379	
	G6			76	64		
STI MF 12 x 1.5	lb	13.948	12.974	21	7	12.324	
STI MF 12 x 1.25	lb	13.624	12.812	21	7	12.271	
STI M 14 x 2	lb	16.598	15.299	22	7	14.433	
STI MF 14 x 1.5	lb	15.948	14.974	21	7	14.324	
STI M 16 x 2	lb	18.598	17.299	22	7	16.433	
STI MF 16 x 1.5	lb	17.948	16.974	21	7	16.324	
STI M 18 x 2.5	lb	21.248	19.624	30	10	18.542	
STI MF 18 x 1.5	lb	19.948	18.974	24	8	18.324	
STI M 20 x 2.5	lb	23.248	21.624	30	10	20.542	
STI MF 20 x 1.5	lb	21.948	20.974	24	8	20.324	
STI M 22 x 2.5	lb	25.248	23.624	30	10	22.542	
STI MF 22 x 1.5	lb	23.948	22.974	24	8	22.324	
STI M 24 x 3	lb	27.897	25.948	30	10	24.649	
STI MF 24 x 1.5	lb	25.948	24.974	24	8	24.324	

Miniature Screw Threads (S)

Unit: mm

Size	Class	Major diameter		Pitch Diameter		Minor diameter	
		Basic Size	Basic Size	Upper Tolerance (µm) +	Lower Tolerance (µm) +	Basic Size	Basic Size
S 0.5 x 0.125	-	0.500	0.419	15	7	0.380	
S 0.6 x 0.15	-	0.600	0.503	15	7	0.456	
	GS2			23	13		
S 0.7 x 0.175	-	0.700	0.586	20	10	0.532	
	GS3			28	18		
S 0.8 x 0.2	-	0.800	0.670	20	10	0.608	
	GS3			28	18		
S 0.9 x 0.225	-	0.900	0.754	20	10	0.684	
	GS4			33	23		

Helical Coil Wire Thread Inserts,
Unified Threads EG(STI) UNC/UNF

Unit: mm

Size	Class	Major diameter		Pitch Diameter		Minor diameter	
		Basic Size	Basic Size	Upper Tolerance (µm) +	Lower Tolerance (µm) +	Basic Size	Basic Size
STI No. 2 - 56 UNC	lb	2.773	2.479	18	6	2.283	
	GH2			25.4	12.7		
STI No. 4 - 40 UNC	lb	3.670	3.258	18	6	2.981	
	GH2			25.4	12.7		
STI No. 4 - 48 UNF	lb	3.532	3.189	18	6	2.958	
STI No. 5 - 40 UNC	lb	4.000	3.589	18	6	3.312	
STI No. 6 - 32 UNC	lb	4.536	4.021	18	6	3.678	
	GH3			38.1	25.4		
STI No. 6 - 40 UNF	lb	4.330	3.919	18	6	3.642	
STI No. 8 - 32 UNC	lb	5.197	4.681	18	6	4.338	
	GH3			38.1	25.4		
STI No. 8 - 36 UNF	lb	5.083	4.625	18	6	4.318	
STI No. 10 - 24 UNC	lb	6.201	5.513	18	6	5.055	
	GH2			25.4	12.7		
STI No. 10 - 32 UNF	lb	5.857	5.341	18	6	4.998	
	GH2			25.4	12.7		
STI No. 12 - 24 UNC	lb	6.861	6.173	18	6	5.716	
STI 1/4 - 20 UNC	lb	8.000	7.174	22	7	6.626	
	GH3			38.1	25.4		
STI 1/4 - 28 UNF	lb	7.528	6.939	18	6	6.545	
	GH2			25.4	12.7		
STI 5/16 - 18 UNC	lb	9.771	8.854	22	7	8.244	
	GH3			38.1	25.4		
STI 5/16 - 24 UNF	lb	9.313	8.624	18	6	8.167	
STI 3/8 - 16 UNC	lb	11.587	10.556	22	7	9.867	
	GH3			38.1	25.4		
STI 3/8 - 24 UNF	lb	10.900	10.212	18	6	9.754	
STI 7/16 - 14 UNC	lb	13.469	12.291	30	10	11.506	
	GH3			38.1	25.4		
STI 7/16 - 20 UNF	lb	12.762	11.937	18	6	11.388	
	GH3			38.1	25.4		
STI 1/2 - 13 UNC	lb	15.238	13.968	30	10	13.122	
	GH3			38.1	25.4		
STI 1/2 - 20 UNF	lb	14.350	13.524	18	6	12.976	
STI 5/8 - 11 UNC	lb	18.875	17.376	30	10	16.376	
STI 5/8 - 18 UNF	lb	17.708	16.791	21	7	16.181	
STI 3/4 - 16 UNF	lb	21.112	20.081	21	7	19.392	

European Steel Conduit Threads (Pg)

Unit: mm

Size	Class	Major diameter		Pitch Diameter		Minor diameter	
		Basic Size	Basic Size	Upper Tolerance (µm) +	Lower Tolerance (µm) +	Basic Size	Basic Size
Pg 7 - 20	-	12.50	11.89	60	30	11.28	
Pg 9 - 18	-	15.20	14.53	60	30	13.86	
Pg 11 - 18	-	18.60	17.93	60	30	17.26	
Pg 13.5 - 18	-	20.40	19.73	60	30	19.06	
Pg 16 - 18	-	22.50	21.83	60	30	21.16	
Pg 21 - 16	-	28.30	27.54	100	50	26.78	
Pg 29 - 16	-	37.00	36.24	100	50	35.48	

SP

SL

PO

ST

ROLL

CARBIDE

LONG

HAND TAPS

EG (STI)

SPECIAL THREADS, GAUGES

THREAD MILLS

DIES

CENTER DRILLS

Technical info

11. Differences between UN and UNJ threads

Intro

SP

The minor diameter of both the external and internal screw threads of a UNJ thread are larger than that of a UN thread. This design is to enhance the bending and shearing strength of an external thread as per the diagrams below.

UNJ screw thread (MIL-S-8879, AS8879 and ISO3161) is one of the Unified screw threads standard and was established for fastening parts of commercial and military aircrafts with threaded components called "Air-fastener". UNJ threads have only one combination of 3A class external threads and 3B class internal threads per size and both are the smallest tolerance for Unified threads to ensure that air fasteners are securely fastened for excessive loads.

SL

The external screw threads of a UNJ have rounded root with radius of specific tolerance for added strength. Yamawa (YMW) taps manufactured for UN threads can be used to produce internal UNJ threads per MIL-S-8879, AS 8879 and ISO 3161.

Internal threads require a minor diameter bore larger than those recommended for UN threads. This larger minor diameter prevents interference of external and internal threads within the tolerance for UNJ standards.

PO

Tapping conditions must be highly accurate to produce an internal screw thread within a 3B class of thread. Thread results can be influenced by tapping conditions such as feed mechanism of tapping, machine, etc.

Tapping machines with synchronized tapping attachment are strongly recommended.

ST

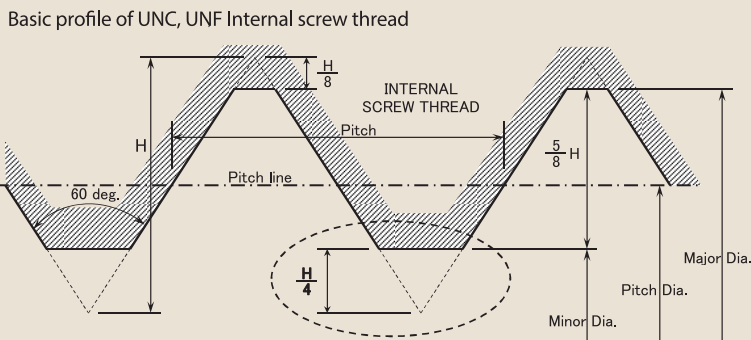

ROLL

CARBIDE

LONG

HAND TAPS

EG (STI)

SPECIAL THREADS, GAUGES

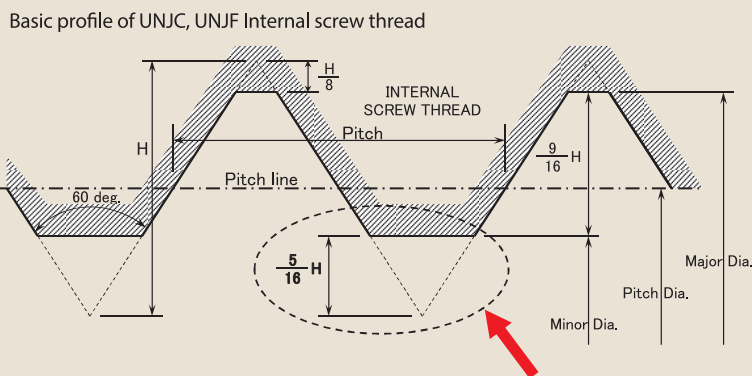

(1) Feature of UNJ threads:

Larger minor diameter (larger core diameter) and rounded root make the external screw threads of a UNJ stronger than a UN thread. Internal UNJ threads require a minor diameter bore larger than those recommended for UN threads while staying within the tolerance of the minor diameter for UNJ standards.

(2) Example:

Limit size for minor diameter of Unified internal threads

1/4-20UNC (2B) Min: 0.1960" (or 4.979 mm) - Max: 0.2070" (or 5.257 mm)

1/4-20UNJC (3B) Min: 0.2013" (or 5.114 mm) - Max: 0.2121" (or 5.387 mm)

THREAD MILLS

DIES

CENTER DRILLS

Technical info

12. Recommended drill sizes for tapping internal UN and UNJ threads

Intro

SP

SL

PO

ST

ROLL

CARBIDE

LONG

HAND TAPS

EG (STI)

SPECIAL THREADS, GAUGES

THREAD MILLS

DIES

CENTER DRILLS

Technical info

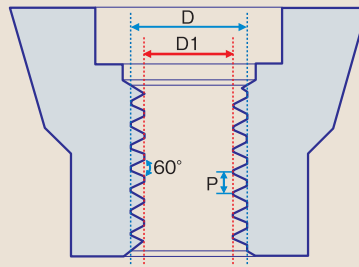

Size	UNC/UNF (ANSI B 1.1)						UNJC/UNJF (SAE AS8879D)					
	Minor diameter D1		Drill size	GH* tap class suitable for 2B thread tolerance		Minor diameter D1		Drill size	GH* tap class suitable for 3B thread tolerance			
	Max.	Min.				Max.	Min.					
No. 2 - 56 UNC/UNJC	1.871	1.695	1.80	GH2		1.859	1.743	1.81	GH1	GH2		
No. 2 - 64 UNF/UNJF	1.912	1.756	1.85	GH2		1.902	1.799	1.86	GH1	GH2		
No. 3 - 48 UNC/UNJC	2.146	1.941	2.10	GH2		2.136	1.999	2.10	GH1	GH2		
No. 3 - 56 UNF/UNJF	2.197	2.025	2.10	GH2		2.189	2.073	2.10	GH1	GH2		
No. 4 - 40 UNC/UNJC	2.385	2.157	2.30	GH2	GH3	2.392	2.228	2.30	GH1	GH2		
No. 4 - 48 UNF/UNJF	2.458	2.271	2.40	GH2		2.466	2.330	2.40	GH1	GH2		
No. 5 - 40 UNC/UNJC	2.697	2.487	2.60	GH2		2.722	2.558	2.60	GH1	GH2		
No. 5 - 44 UNF/UNJF	2.740	2.551	2.70	GH2		2.763	2.614	2.70	GH1	GH2		
No. 6 - 32 UNC/UNJC	2.895	2.642	2.80	GH3	GH4	2.938	2.734	2.85	GH2	GH3		
No. 6 - 40 UNF/UNJF	3.022	2.820	2.90	GH2		3.053	2.888	3.00	GH1	GH2		
No. 8 - 32 UNC/UNJC	3.530	3.302	3.40	GH3	GH4	3.599	3.394	3.50	GH2	GH3		
No. 8 - 36 UNF/UNJF	3.606	3.404	3.50	GH3		3.662	3.480	3.60	GH2	GH3		
No. 10 - 24 UNC/UNJC	3.962	3.683	3.90	GH3	GH5	4.064	3.795	4.00	GH2	GH3		
No. 10 - 32 UNF/UNJF	4.165	3.963	4.10	GH3	GH4	4.254	4.054	4.20	GH2	GH3		
No. 12 - 24 UNC/UNJC	4.597	4.344	4.50	GH3		4.704	4.456	4.60	GH2	GH3		
No. 12 - 28 UNF/UNJF	4.724	4.496	4.60	GH3		4.815	4.603	4.70	GH2	GH3		
1/4 - 20 UNC/UNJC	5.257	4.979	5.10	GH3	GH5	5.387	5.114	5.30	GH2	GH3		
1/4 - 28 UNF/UNJF	5.588	5.360	5.50	GH3	GH4	5.661	5.467	5.60	GH2	GH3		
5/16 - 18 UNC/UNJC	6.731	6.401	6.60	GH3	GH5	6.832	6.564	6.70	GH2	GH3		
5/16 - 24 UNF/UNJF	7.035	6.782	6.90	GH3	GH4	7.109	6.907	7.00	GH2	GH3		
3/8 - 16 UNC/UNJC	8.153	7.798	8.00	GH3	GH5	8.255	7.979	8.10	GH3			
3/8 - 24 UNF/UNJF	8.636	8.382	8.50	GH3	GH5	8.679	8.494	8.60	GH2	GH3		
7/16 - 14 UNC/UNJC	9.550	9.144	9.40	GH4	GH5	9.639	9.348	9.50	GH3			
7/16 - 20 UNF/UNJF	10.033	9.729	9.90	GH3	GH4	10.083	9.876	10.00	GH2	GH3		
1/2 - 13 UNC/UNJC	11.023	10.592	10.90	GH4	GH5	11.094	10.798	11.00	GH3			
1/2 - 20 UNF/UNJF	11.607	11.329	11.50	GH3	GH4	11.661	11.464	11.60	GH3			
9/16 - 12 UNC/UNJC	12.446	11.989	12.20	GH4		12.481	12.228	12.40	GH3			
9/16 - 18 UNF/UNJF	13.081	12.751	12.90	GH4		13.121	12.914	13.00	GH3			
5/8 - 11 UNC/UNJC	13.868	13.386	13.60	GH4	GH5	13.903	13.628	13.80	GH3			
5/8 - 18 UNF/UNJF	14.681	14.351	14.50	GH4	GH5	14.701	14.501	14.60	GH3			
3/4 - 10 UNC/UNJC	16.840	16.307	16.60	GH4	GH5	16.880	16.577	16.70	GH3			
3/4 - 16 UNF/UNJF	17.678	17.323	17.50	GH4	GH5	17.721	17.506	17.60	GH3			

* The most suitable GH tap class to cut accurate 2B, 3B (UNJ) and 2B oversized internal threads tolerance, depends on application conditions and work-piece materials. Yamawa GH class system offers a wide range of alternative tap classes allowing each customer to select the most suitable one according to application requirement.

13. Introduction to Thread Forming Taps (Roll Taps)

Intro

SP

Thread Forming Taps are the tools used for producing internal threads by a thread forming process. Currently, Yamawa's Thread Forming Taps have a good reputation by being used in many areas. They are widely used along with the diversity of workpieces and with the change into miniaturization of workpieces. Followings are the features of Thread Forming Taps (Roll Taps) which are not available with cutting taps.

Features of Roll Taps

SL

- Tapping without producing chips. They are suitable for blind and through hole tapping. In producing internal threads with no chips, they save you a time for chip disposal.
- Roll taps are stronger than cutting taps due to their design. The effect of fluteless design gives a large cross-section area to the tap, and there is no worry of chip jamming, which makes Roll taps very tough against breakage.

PO

- Roll taps produce excellent pitch diameter well within pitch diameter tolerances. Material deformation process produces the internal threads with good surface finish as well as precise pitch diameter.
- High efficiency and tool life. The configuration of the lobes at the crests of the tap threads makes high speed tapping possible and extends tool life compared with cutting taps. The addition of a supplemental tap surface treatment, such as Oxidizing, Nitriding, TiN, and TiCN can extend tool life 2 to 20 times longer than uncoated (bright) tap performance.

ST

Points to note during a Roll tapping operation

ROLL

- Tapping torque is 2 to 3 times larger than that of cutting taps.
- Roll tapping is only applicable to materials producing stringy chips.
- The deviation of hole size before tapping should be about 5% of pitch. The control of hole size before tapping should be more severe than that of cutting taps.
- The selection of lubricants is important to prevent sticking or welding.

CARBIDE

- Burrs at the face of an internal thread are larger than those produced by cutting taps. In some cases it is necessary to take additional countersink processing at the top of hole.
- In the minor diameter of internal thread, U-shape form (Tine form) at the hole entrance can be seen. U-shape form is never seen when using cutting taps.

LONG

Selection of Yamawa Roll Taps

HAND TAPS

- Types of Roll Taps. Yamawa produces various types of Roll Taps which include General purpose taps, Special purpose taps for non-ferrous and steel, as well as special purpose taps with surface treatment for the specified applications. To provide for longer tool life, specially developed premium materials are also used together with physical vapor deposition coating (PVD) such as TiN and TiCN. In particular, OL-RZ is superior product developed for dry machining with regards to tapping environment and performance.

EG (STI)

- Tap Materials. Yamawa's standard tap material is SKH58 designed for improving torque, superior anti-friction properties as well as toughness. To extend tool life, we use SKH56, or SKH10 (Powder HSS) which is the best tap material for antifriction.
- Tolerance Class. Using the datum 12.7 μm in a step form, in accordance with ANSI standard GH class, we made up Yamawa's G class system. The differences in materials being Roll tapped, as well as hole size, contribute to differences in thread forming. Yamawa offers 2 to 3 oversized tap tolerance classes in order to achieve the most suitable internal thread pitch diameter size.
- Chamfer length. 2 pitches for blind hole use and 4 pitches for through hole use. Basically 4 pitches have longer tool life than 2 pitches because force applied on one blade at 4 pitch chamfer is smaller than that at 2 pitch chamfer. However, it is difficult to say about tool life in a few words because each different tapping condition influences the tool life.

SPECIAL THREADS, GAUGES

THREAD MILLS

DIES

CENTER DRILLS

Technical info

Shape of internal threads and ratio of thread engagement affected by bored hole diameter

Compared with the basic height of thread engagement, the actual height of the thread engagement is called "thread engagement ratio" in percentage.

Depending on the bored hole diameter, internal thread and thread engagement ratio will change.

The tapping condition must be chosen by referring to the thread engagement ratio.

The portion of material to be formed can be reduced by selecting the largest possible bored hole diameter. In this way the load on taps is reduced, decreasing tap's wear and damage.

Ck45, minor diameter of thread (cutting process)
M24x3
minor diameter tolerance of internal thread
Ø20.752 - Ø21.252

[Ck45 internal thread cut] M24x3 bored hole size: Ø20.652 minor dia tolerance of internal thread NG thread engagement ratio: 103.1%	
[Ck45 internal thread cut] M24x3 bored hole size: Ø21.000 minor dia tolerance of internal thread: Middle thread engagement ratio: 92.4%	
[Ck45 internal thread cut] M24x3 bored hole size: Ø21.352 minor dia tolerance of internal thread NG thread engagement ratio: 81.5%	

Aluminum, minor diameter of thread (forming process)
M25x2
minor diameter tolerance of internal thread
Ø22.835 - Ø23.210

[Aluminum, internal thread formed] M25x2 bored hole size: Ø23.903 minor diameter of finished internal thread : 22.723 mm minor dia tolerance of internal thread NG thread engagement ratio: 105.2%	
[Aluminum, internal thread formed] M25x2 bored hole size: Ø24.042 mm minor diameter of finished internal thread : 23.067 mm minor dia tolerance of internal thread : Middle thread engagement ratio: 89.3%	
[Aluminum, internal thread formed] M25x2 bored hole size: Ø24.240 mm minor diameter of finished internal thread : 23.462 mm minor dia tolerance of internal thread NG thread engagement ratio: 71.0%	

Example of thread engagement for M6x1 cutting and forming tap

Boring before tapping - Check 1

Symbol	Engagement classification	Engagement length classification			Engagement length
		Fine	Middle	Coarse	
S	Short engagement length	4H	5H	—	5 ≤ 3 (mm)
M	Normal engagement length	5H	6H	7H	3 < M ≤ 9 (mm)
L	Long engagement length	6H	7H	8H	9 < L (mm)

Length of engagement
On "middle" engagement class, 7H class can be chosen in case of "L" engagement length.

Length of engagement = 9.1mm
d = 6.0mm
P = 1.0mm

Bored hole size	Drill size (ref.)	D1	
		Min	Max
5.0	4.917	5.153	
Engagement ratio	92.4%	100%	78.2%

D1 is minor diameter of 6H internal threads

*Hole size for thread forming taps	
Min	Max
5.49	5.59

*Forming condition changes depending on workpiece's Material and shape. Above is for customer's reference.

14. Materials used for Cutting Tools

Intro

Materials

SP

We have been seeking the best materials used for cutting tools since the company establishment because the performance of tools depends on the selection of materials used. Major materials used in our company are listed below.

SL

PO

ST

ROLL

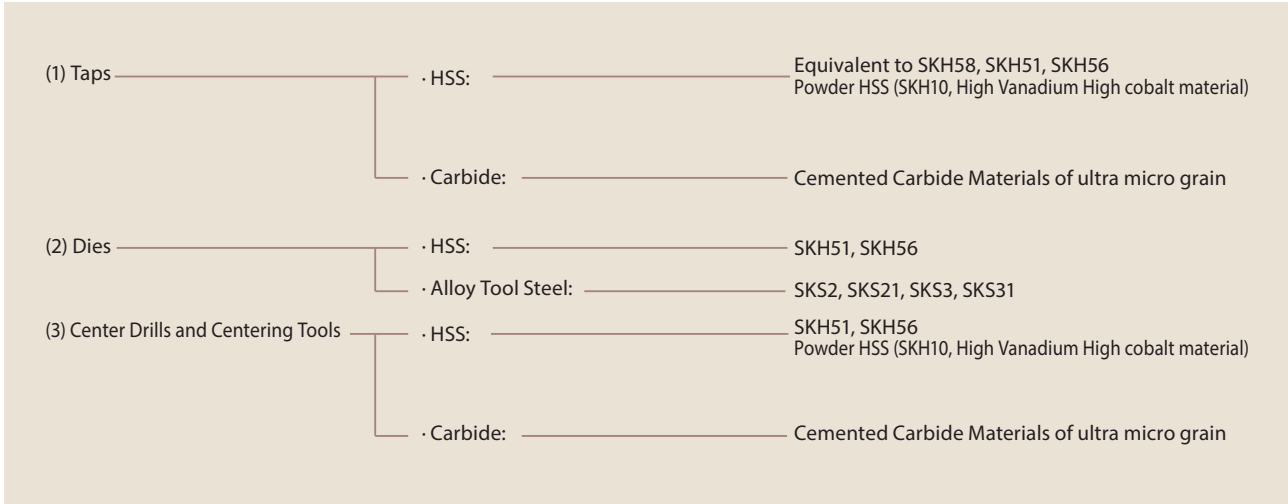

*For product's improvement, material may be changed without notice.

CARBIDE

Overview on tools materials

LONG

Tensile strength, heat resistance, corrosion resistance and accuracy are the important features required of tool's materials. These requirements have been changing due to miniaturization and lightening of parts.

And manufacturing methods, as well, have been changing because of necessity of economical efficiency such as saving process/cycle time while parts become hard-to-machine type and their hardness increases.

As a result, the demand of industrial tools by users has become very tough.

For example, higher wear resistance and chipping resistance are required in the area of hardness, and heavy cutting process or high-speed cutting are required in the area of cycle time.

HAND TAPS

Moreover, product accuracy with its rigidity, laborsaving brought by uniformity, and systematic reliability are highly required.

Therefore, technological improvement of tool steels never stops developing so that they satisfy users needs.

- The major materials used for taps are already listed in the chart, but those materials are ready to develop from conventional alloy tool steels and current high speed steel into next generation materials such as cemented carbide and cermet materials.

EG (STI)

New materials are developed even in high-speed tool steel area, such as SKH51 and SKH58 from SKH2, and they are moving into high performance materials, such as high vanadium, cobalt, and powder HSS made of high vanadium and high cobalt contents.

- As the material for round dies, alloy tool steels are mostly used because of the relationship with the use of adjustable round dies. However, for the hard-to-machine material, die material has been shifted into High Speed Steel.

- Major materials for center drills and centering tools are high speed steel materials, but they have been shifting to cobalt type or even cemented carbide from SKH51.

SPECIAL THREADS, GAUGES

We keep on seeking to develop our technology to meet user's needs and are trying to find the best materials in collaboration with steel manufacturers.

THREAD MILLS

DIES

CENTER DRILLS

Technical info

Chemical composition of the materials specified in JIS

Classification	Symbol	Chemical composition									
		C	Si	Mn	P	S	Cr	Mo	W	V	Co
W Type HSS	SKH 2	0.73-0.83	≤0.45	≤0.4	≤0.030	≤0.030	3.80-4.50	-	17.20-18.70	1.00-1.20	-
	SKH 3	0.73-0.83	≤0.45	≤0.4	≤0.030	≤0.030	3.80-4.50	-	17.00-19.00	0.80-1.20	4.50- 5.50
	SKH 4	0.73-0.83	≤0.45	≤0.4	≤0.030	≤0.030	3.80-4.50	-	17.00-19.00	1.00-1.50	9.00-11.00
	SKH10	1.45-1.60	≤0.45	≤0.4	≤0.030	≤0.030	3.80-4.50	-	11.50-13.50	4.20-5.20	4.20- 5.20
Mo Type HSS	SKH51	0.80-0.88	≤0.45	≤0.4	≤0.030	≤0.030	3.80-4.50	4.70- 5.20	5.90- 6.70	1.70-2.10	-
	SKH52	1.00-1.10	≤0.45	≤0.4	≤0.030	≤0.030	3.80-4.50	5.50- 6.50	5.90- 6.70	2.30-2.80	-
	SKH53	1.15-1.25	≤0.45	≤0.4	≤0.030	≤0.030	3.80-4.50	4.70- 5.20	5.90- 6.70	2.70-3.20	-
	SKH54	1.25-1.40	≤0.45	≤0.4	≤0.030	≤0.030	3.80-4.50	4.20- 5.00	5.20- 6.00	3.70-4.20	-
	SKH55	0.87-0.95	≤0.45	≤0.4	≤0.030	≤0.030	3.80-4.50	4.70- 5.20	5.90- 6.70	1.70-2.10	4.50- 5.00
	SKH56	0.85-0.95	≤0.45	≤0.4	≤0.030	≤0.030	3.80-4.50	4.70- 5.20	5.90- 6.70	1.70-2.10	7.00- 9.00
	SKH57	1.20-1.35	≤0.45	≤0.4	≤0.030	≤0.030	3.80-4.50	3.20- 3.90	9.00-10.00	3.00-3.50	9.50-10.50
	SKH58	0.95-1.05	≤0.7	≤0.4	≤0.030	≤0.030	3.50-4.50	8.20- 9.20	1.50- 2.10	1.70-2.20	-
	SKH59	1.05-1.15	≤0.7	≤0.4	≤0.030	≤0.030	3.50-4.50	9.00-10.00	1.20- 1.90	0.90-1.30	7.50- 8.50

Classification	Symbol	Usage	Cross chart		
			AISI	VDEH	ISO
W Type HSS	SKH 2	Tools for general cutting and other kinds of tools	T 1	S18-0-1	S1 (HS18-0-1)
	SKH 3	Tools for high speed heavy cutting and other kinds of tools	T 4	S18-1-2-5	S7 (HS18-1-1-5)
	SKH 4	Tools for cutting hard -to-machine materials and other kinds of tools	T 5	S18-1-2-10	S6 (HS18-0-1-10)
	SKH10	Tools for cutting ultra hard-to-machine materials and other kinds of tools	T 15	-	S9 (HS12-1-5-5)
Mo Type HSS	SKH51	General cutting tools from which toughness is particularly required, and other kinds of tools	M 2	S6-5-2	S4 (HS6-5-2)
	SKH52	Tools for cutting high hardness material from which	M 3-1	-	-
	SKH53	comparatively high toughness is required and other kinds of tools	M 3-2	S6-5-3	S5 (HS6-5-3)
	SKH54	Tools for cutting ultra hard-to-machine materials and other kinds of tools	M 4	-	-
	SKH55	High speed cutting tools from which comparatively high	M 35	S6-5-2-5	S8 (HS6-5-2-5)
	SKH56	toughness is required and other kinds of tools	M 36	-	-
	SKH57	Tools for cutting ultra hard-to-machine materials and other kinds of tools	-	S10-4-3-10	S10 (HS10-4-3-10)
	SKH58	General cutting tools from which toughness is particularly required, and other kinds of tools	M 7	S2-9-2	S2 (HS2-9-2)
	SKH59	High speed heavy cutting tools from which comparatively high toughness is required, and other kinds of tools	M 42	S2-10-1-8	S11 (HS2-9-1-8)

The standard of HSS material is specified in JIS. But there are many HSS materials which standard is not specified in JIS. Recently even the kind of HSS-P is getting wider and various. Besides, SKH10, SKH53, SKH57 and their equivalents, such Hi vanadium/hi cobalt material as contains 4-12% vanadium and 8-11% cobalt is now being manufactured. Material engineering will be developed rapidly in the future. Under such situation, there can be many cases where JIS symbols are not used, and the use of larger classification and their symbols is getting popular.

15. Surface Treatment

Intro

SP

The best surface treatment is applied to each tap depending on the tapping purpose. Characteristics and effectiveness of surface treatment are introduced at next section.

Oxidizing

SL

- This treatment was processed by using HOMO furnace being made by LEED AND NORTHUP company USA in 1938, and it is called HOMO treatment. This treatment is also called vapor treatment and steam treatment. Through this treatment, Fe_3O_4 layer of blue black color is produced over the tool surface.

PO

- Oxidization treatment produces porous layer on tool's surface. This porous layer works as oil pocket to reduce friction, to avoid welding and to improve the surface roughness of internal screw. Moreover, longer tool life is expected because the treatment reduces the remaining stress of HSS tools.

ST

- This treatment does not increase the hardness on tool surface. Using the furnace of YAMAWA original design and choosing the proper treatment time, we have marked good result of oxidizing for YAMAWA HSS tools.

- Stainless steel and low carbon steel are the materials that are easy to get welding. We are applying this treatment to the special purpose taps for these materials to get good result. Further due to the reduction of friction force, this treatment has good result for wide range of steel type material.

- We combine oxidizing with nitriding for the taps designed for thermal refined steels of high carbon steels and alloy steels. This double treatment wins good reputation of the market.

ROLL

Thickness of oxide layer and the time of treatment

Comparison between bright and oxide treated

CARBIDE

LONG

HAND TAPS

EG (STI)

SPECIAL THREADS, GAUGES

THREAD MILLS

DIES

CENTER DRILLS

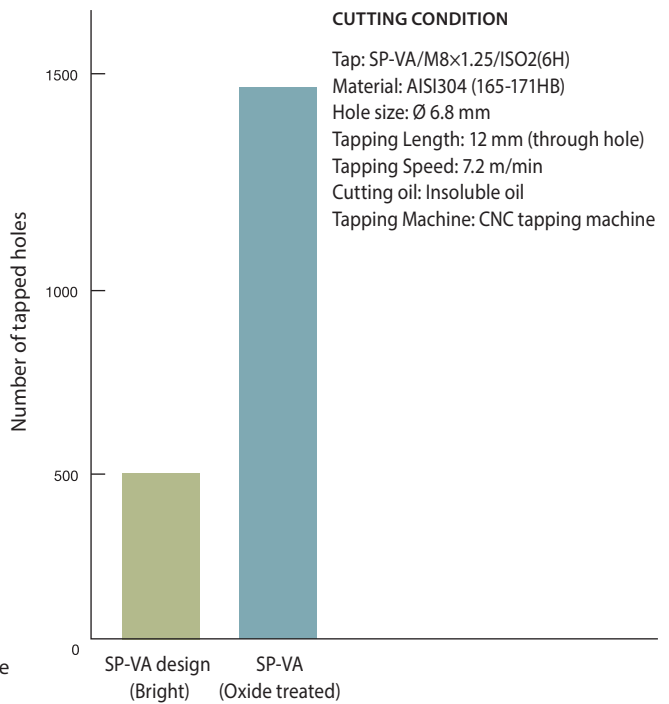
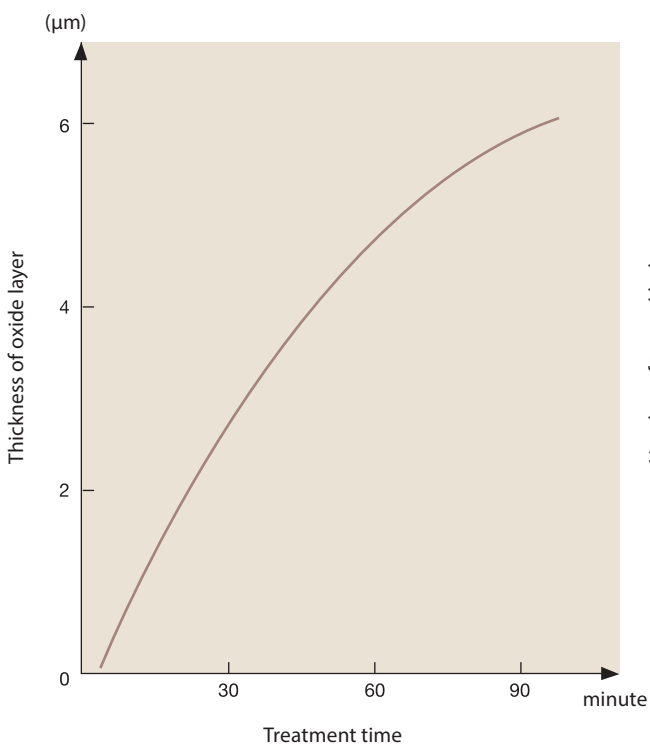

Technical info

Nitriding

- In this treatment, we have Nitrogen and Carbon soak into the surface of HSS tools, and react with chemical of HSS material to produce hard nitride. There are 3 methods in the treatment, composition gas method, salt bath nitride method and ion nitride method.
- Salt bath nitride treatment is shifted into gas nitride treatment method because of cyanic environmental pollution.
- The temperature of treatment is 500 to 550 degree. Hardness and depth of the treatment can be controlled by active nitrogen concentration and reaction time.
- The high hardness of tool surface minimizes chemical attraction. Result is less welding and friction reduction. Great improvement is expected in tool's performance.
- We have found out the best combinations of hardness and toughness through our treatment technology
- The nitride treatment will be widely applicable to the taps for such workpiece materials as gray cast irons, special cast irons, aluminum diecastings with higher silicone content, copper alloys, and resinoids (plastics). These materials produce small segmental chips and are very abrasive.
- We combine nitrogen and oxidizing for comparatively sticky material such as thermal refined steels of high carbon steel and alloy steel. This double treatment improves the chipping resistance and have won good reputation.

Depth and hardness of Nitride Surface Treatment

Comparison between bright and nitride treated

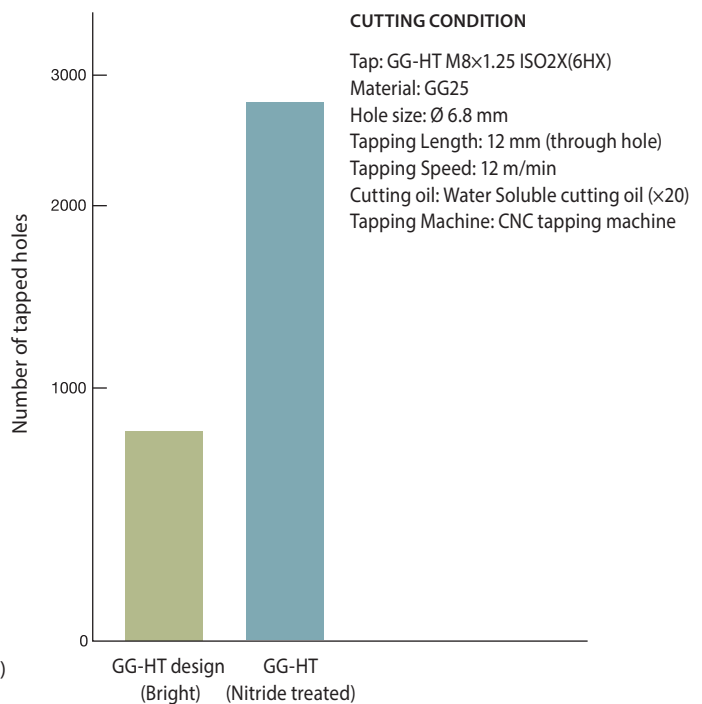
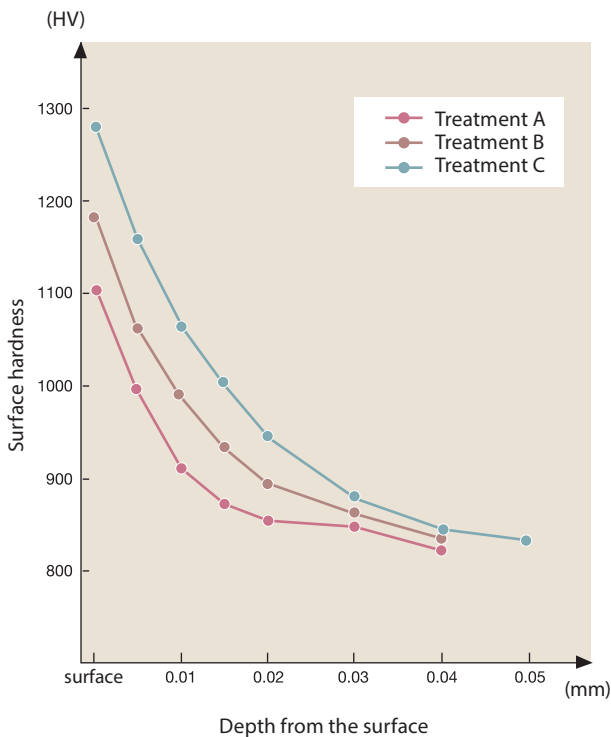

15. Surface Treatment

Intro

Hard coating

SP

High speed cutting and hard-to-machine material cutting are the recent technology. To meet this tendency, the hard layer coating by vapor deposition over tool's surface has become popular. There are two coating methods, CVD and PVD. PVD is mainly used for tap.

Physical Vapor Deposition

SL

- Inside of the container of high vacuum, are vapor deposition materials heated. And we vapor-deposit particles ionized by electric discharge on tool's surface.
- Due to its low reaction temperature (lower than 500°C), PVD makes little change in shape and hardness of HSS tools.

PO

The features and classification of coating

ST

ROLL

CARBIDE

LONG

Classification	Titanium nitride (TiN)	Titanium carbonitride (TiCN)	Titanium nitride aluminium (TiAlN)	Chromium nitride (CrN)
Features				
Vickers Hardness	2000-2400	3000-3500	2300-2700	1800-2200
Wear resistance	Good	Excellent	Excellent	Normal
Welding resistance	Good	Good	Good	Excellent
Heat resistance	Good	Normal	Excellent	Excellent
Acid resistance	Good	Normal	Excellent	Good
Slippery	Good	Excellent	Good	Excellent
Color	Gold	Blue Gray - Violet	Violet	Silver
Workpiece materials	Carbon Steel Aluminum forging	Carbon Steel Hard Steel Stainless Steel Aluminum forging Cast Iron Brass, Bronze	Stainless Steel Cast Iron	Copper

Note: Evaluation (tri-level) of characteristic features is just comparative of these four coatings, TiN, TiCN, TiAlN, and CrN, in the table. These coatings have great advantages of wear resistance, welding resistance, and friction reduction. The values of vickers hardness are also higher than the heat treatment or nitriding of HSS cutting tools from the table.

HAND TAPS

Comparison between bright and TiN coated

Comparison between bright and TiCN coated

EG (STI)

SPECIAL THREADS, GAUGES

THREAD MILLS

DIES

CENTER DRILLS

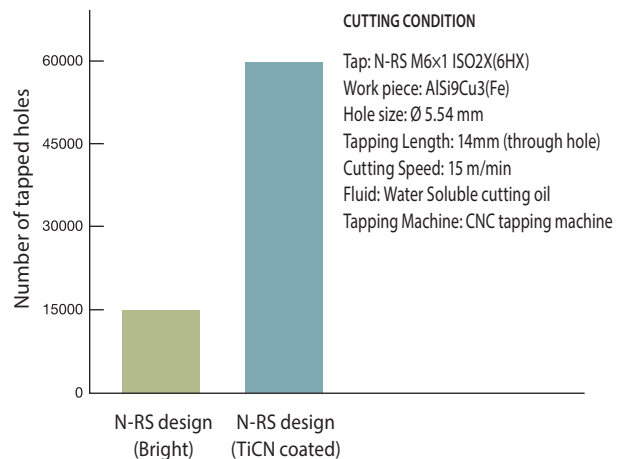
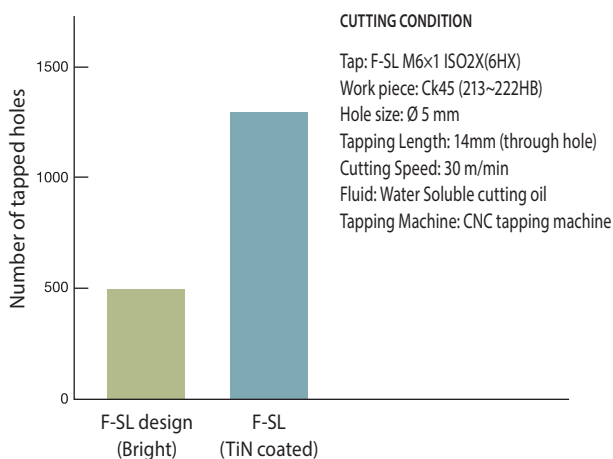

Technical info

16. Carbide Taps

Intro

Technological advances in CNC machines and machining centers, and machining automation have helped to improve the overall tapping process.

YAMAWA was quick to answer to the evolving customer needs.

We have developed a wide range of carbide taps for tremendous improvements in mass-production and cost reduction. It is estimated that carbide taps have 50 times more durability than HSS taps in tapping, when used properly. YAMAWA engineering believes the best carbide materials suitable for taps are ultramicro-grain tungsten carbide, or ultrafine-grain carbide made of high cobalt.

SP

SL

Features of Carbide Taps

- (1) Excellent durability with high toughness is obtainable.
- (2) High anti-friction features are provided by the material's high hardness and comparatively high toughness, which ultimately results in a longer tool life.
- (3) Specially designed cutting angle and other dimensional features produce the internal threads with high tolerance accuracy and consistency.
- (4) Under certain tapping condition, YAMAWA carbide taps can be used even for tapping hard-to-machine materials.

PO

Points to note during tapping with Carbide taps:

- (1) Machine vibration, or run-out, can lead to Carbide tap chipping and premature failure. Tapping vibrations need to be kept to a minimum.
- (2) Tap holder should be a rigid type for a Carbide tap. A holder attachment with axial float, or radial float tends to promote Carbide tap breakage and chipping.
- (3) The hole to be tapped must be located correctly and on center; any centering off or non-straight drilled hole tends to cause Carbide tap breakage due to deflection. Select correct hole depth with respect to tapping length (for blind hole only). It is especially important to prevent tap damage from chip packing and bottom thrusting in blind hole tapping.
- (4) Cutting lubricants - select grade of lubricant. Improper flow of coolant, or lack of sufficient amount of lubricant, or cooling can increase the likelihood of Carbide tap chipping due to work material welding. Caution must be taken during dry machining to prevent chip welding to the tap.
- (5) Work pieces - we provide Carbide taps with increased toughness, but Carbide taps are inferior to High Speed Steel (HSS) in the area of toughness. As a matter of fact Carbide taps have limited application due to this difference in toughness to HSS.

ST

ROLL

CARBIDE

Commonly used materials and cutting conditions

Work Materials		Cutting Speed (m/min)	Cutting Fluid (General recommendation)
Cast Iron	Ordinary	15-25	Dry, light oil, water soluble oil
	Nodular Graphite	10-20	Light oil, water soluble oil
	Malleable	10-20	Water soluble oil
Aluminum		20-40	Light oil, water soluble oil
Copper		15-30	Light oil, water soluble oil
Copper Alloy	Brass	20-30	Light oil, water soluble oil
	Phosphor Bronze	15-30	Light oil, water soluble oil
Die-Cast	Aluminum Alloy	15-25	Mixed oil of lard oil and kerosene
	Zinc Alloy	12-20	Mixed oil of lard oil and kerosene
Plastic	Thermosetting	15-25	Water soluble oil, air
	Thermo Plastic	15-25	Water soluble oil, air
Hard Rubber		15-30	Dry, air

Note: The table shows only general conditions. As for actual cutting operation, please consider the following points: (1) Machine Capacity, (2) Work piece(s), (3) Work Shape, (4) Setup (5) other factors.

LONG

HAND TAPS

EG (STI)

SPECIAL THREADS, GAUGES

THREAD MILLS

DIES

CENTER DRILLS

Technical info

16. Carbide Taps

Intro

SP

SL

PO

ST

ROLL

CARBIDE

LONG

HAND TAPS

EG (STI)

SPECIAL THREADS, GAUGES

THREAD MILLS

DIES

CENTER DRILLS

Technical info

Toughness and Hardness of Cemented Carbide and HSS

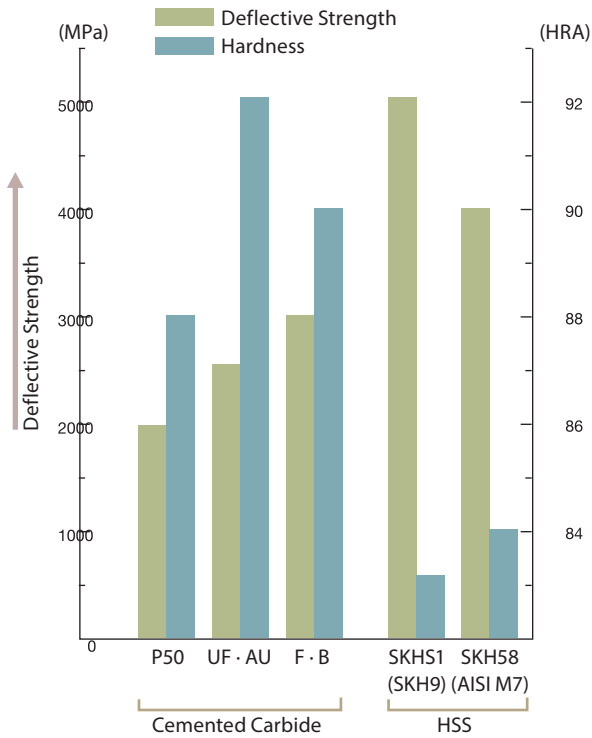

Chamfer wear and number of holes of Carbide taps and HSS taps

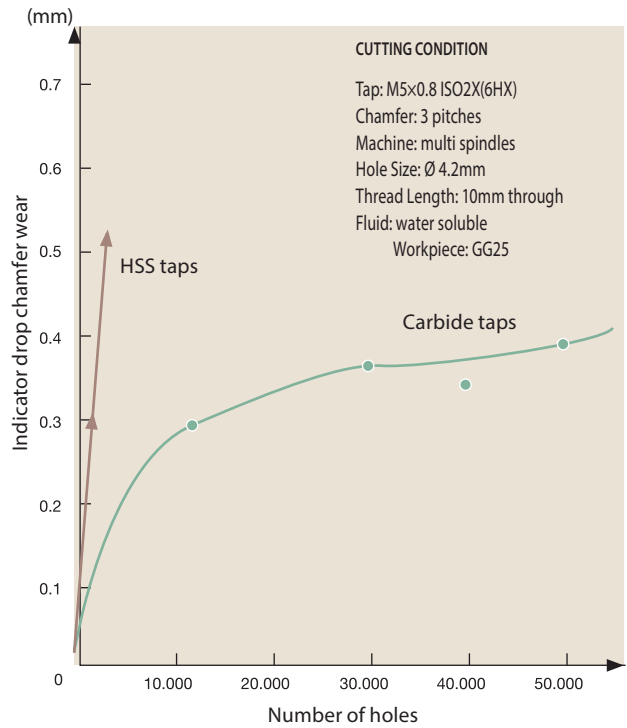

Features		Size	M 2 x 0.4	M 8 x 1.25	M 6 x 1	M 8 x 1.25	M 10 x 1.25
		Material	Plastic with glass fibre	AlSi9Cu3(Fe)	GG25	GG25	GG25
Workpiece	Part's name	Electric Parts	Car Parts	Electric Parts	Car Parts	Car Parts	
Thread condition	Tapping hole condition	Ø 1.6 Through	Ø 6.7 Blind	Ø 5.0 Blind	Ø 6.7 Blind	Ø 8.7 Blind	
	Tapping length	4 mm	18 mm	10 mm	16mm	18 mm	
Condition of use	Machine	Special Machine	Special Machine	4 spindle Machine	Multi Spindle Machine	Special Machine	
	Cutting speed	6.3 m/min	8.5 m/min	8 m/min	6 m/min	5.7 m/min	
	Fluid	Dry	Water soluble	Water soluble	Water soluble	Water soluble	
Number of holes	Carbide tap	10.000	75.400	53.000	18.860	38.500	
	HSS tap	200	1.000	1.000	300	500	
	Comparison of life	50	75.4	53	62.9	77	

Note: In all situations, HSS taps being used are standard ones. Carbide taps, when used properly, bring out a long tool life. These data have come from end users of carbide taps.

17. Taps for Pipe Threads

JIS Pipe Taps

The pipe thread standard (JIS B 0202,0203) was revised in 1982 to meet ISO standard. In the same year, JIS B 4445 (straight pipe thread taps) and JIS B 4446 (taper pipe thread taps) were also revised.

- A part of the pipe thread standard was revised in 1966 to meet ISO, but in the 1982 revision, the ISO standard was defined in the main book of JIS and the old 1966 standard was defined in JIS Appendix. For Pipe Threads specified in the main book of JIS and JIS Appendix, thread symbols are different but the nominal size 1/8 to 6 inch are same. In the 1998 revision, the contents of the main book of JIS and JIS Appendix are not changed.
- ISO tap standard for pipe threads is different from the JIS tap standard in style, size and thread limit. Like the pipe thread standard, in JIS tap standards for pipe threads, style, size and thread limits of ISO standard are adopted in the main book of JIS and those of old JIS standard are in the JIS Appendix. For ISO standard (style and size), please refer to the next page.
- Thread limits of Rp and G taps are the same as the ISO standard. The thread limit of Rc taps is the same as the JIS class 2 of PT taps shown in JIS Appendix because Rc is not specified in the ISO standard. Therefore, both Rc taps and PT taps can be used interchangeably. For the relation between thread limit of internal threads and tap thread limit, please refer to the table below.
- Pipe Tap standard was revised in 1987. And tap designations shown in JIS Appendix were changed to PF taps for Parallel Pipe Thread, PT taps for Taper Pipe Thread, and PS taps for Parallel Pipe Thread.

Symbol of Pipe threads

Type	Classification		Standard	JIS (ISO)	JIS Appendix
Taper Thread	Taper Thread	Internal Thread	JIS B 0203-1982	Rc	PT
		External Thread		R	PT
	Parallel Thread	Internal Thread		Rp	PS
		External Thread		-	-
Parallel Thread	Parallel Thread	Internal Thread	JIS B 0202-1982	G	PF, A class
		Internal Thread		-	PF, B class
		Internal Thread		G, A class	PF, A class
		Internal Thread		G, B class	PF, B class

Relation between classification/engagement of pipe threads and taps

Kind of thread	Classification	Main usage	Type	Engagement	pipe taps	
Pipe thread	Taper pipe threads	In connection of pipes, pipe parts and fluid parts they are used mainly for the purpose of pressure type joints.	Internal threads	Parallel PS (Rp)		PS
				Taper PT (Rc)		PT
			External threads	Taper PT (R)		S-PT
	Parallel pipe threads	In connection of pipes, pipe parts and fluid parts, they are used mainly for the purpose of mechanical type joints.	Internal threads	PF (G)		PF
				External threads	PF (G)	

Intro

SP

SL

PO

ST

ROLL

CARBIDE

LONG

HAND TAPS

EG (STI)

SPECIAL THREADS, GAUGES

THREAD MILLS

DIES

CENTER DRILLS

Technical info

17. Taps for Pipe Threads

Intro

Comparison of the thread limit of taper pipe tap

Unit mm

SP

Rc

PT

S-PT

SL

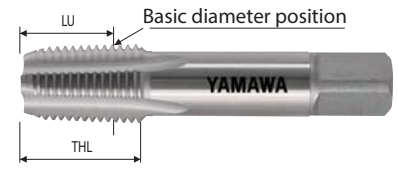
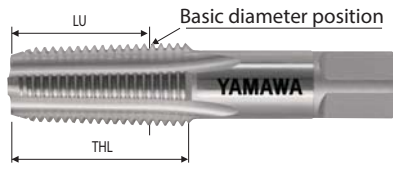
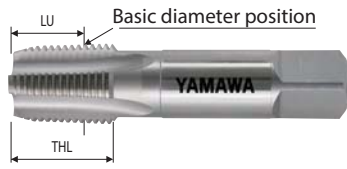

PO

ST

ROLL

CARBIDE

LONG

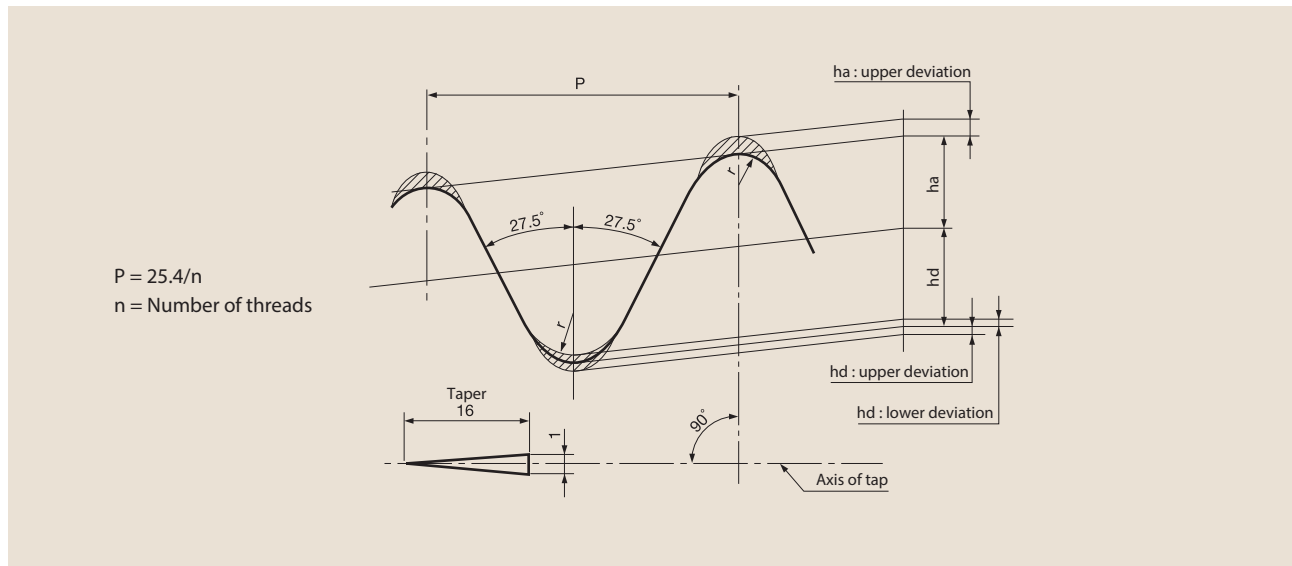

HAND TAPS

Comparison of the thread limit of taper internal pipe taps

Unit: mm

EG (STI)

SPECIAL THREADS, GAUGES

THREAD MILLS

DIES

Size	Basic major Dia. of Gauge Plane	Number of Threads (per inch)	ISO (Rc)		Appendix (PT)				Thread Limit			
			Thread Length	Basic Diameter Position	PT Threads		S-PT Thread		ha		hd	
					Thread Length	Basic Diameter Position	Thread Length	Basic Diameter Position	Basic Size (mm)	Tolerance	Basic Size (mm)	Tolerance
1/16	7.723	28	14	10.1	-	-	-	-	0.291	0-30	0.291	±15
1/8	9.728	28	15	10.1	19	13	16.5	10.5	0.291	0-30	0.291	±15
1/4	13.157	19	19	15	28	21	19.5	12.5	0.428	0-40	0.428	±20
3/8	16.662	19	21	15.4	28	21	21	14	0.428	0-40	0.428	±20
1/2	20.955	14	26	20.5	35	25	27	17	0.581	0-50	0.581	±25
3/4	26.441	14	28	21.8	35	25	29	19	0.581	0-50	0.581	±25
1	33.249	11	33	26	45	32	35	22	0.740	0-60	0.740	±30
1 1/4	41.910	11	36	28.3	45	32	37.5	24.5	0.740	0-60	0.740	±30
1 1/2	47.803	11	37	28.3	45	32	38.5	25.5	0.740	0-60	0.740	±30
2	59.614	11	41	32.7	50	35	42.5	27.5	0.740	0-60	0.740	±30
2 1/2	75.184	11	45	37.1	-	-	-	-	0.740	0-60	0.740	±30
3	87.884	11	148	40.2	-	-	-	-	0.740	0-70	0.740	±35
4	113.030	11	53	46.2	-	-	-	-	0.740	0-70	0.740	±35

CENTER DRILLS

Technical info

Comparison of the thread limit of parallel pipe taps

Unit: mm

Size	Number of Threads (per inch)	Pitch (mm)	Thread Limit of ISO (G)								Thread Limit of Appendix of PF								
			Major Dia		Pitch Dia				Minor Dia		Major Dia		Pitch Dia				Minor Dia		
			Basic Size (mm)	LT (+)	Basic Size (mm)	UT (+)	LT (+)	Tolerance	Basic Size (mm)	UT	Basic Size (mm)	LT (+)	Basic Size (mm)	UT (+)	LT (+)	Tolerance	Basic Size (mm)	UT (+)	
1/16	28	0.9071	7.723	32	7.142	43	21	22	6.561	Not Specified	-		-				-		
1/8	28	0.9071	9.728	32	9.147	43	21	22	8.566		9.728	65	9.147	40	20	20		8.566	40
1/4	19	1.3368	13.157	37	12.301	50	25	25	11.445		13.157	90	12.301	50	25	25		11.445	50
3/8	19	1.3368	16.662	37	15.806	50	25	25	14.950		16.662	90	15.806	50	25	25		14.950	50
1/2	14	1.8143	20.955	43	19.793	57	28	29	18.631		20.955	115	19.793	55	25	30		18.631	55
5/8	14	1.8143	22.911	43	21.749	57	28	29	20.587		22.911	115	21.749	55	25	30		20.587	55
3/4	14	1.8143	26.441	43	25.279	57	28	29	24.117		26.441	115	25.279	55	25	30		24.117	55
7/8	14	1.8143	30.201	43	29.039	57	28	29	27.877		30.201	115	29.039	55	25	30		27.877	55
1	11	2.3091	33.249	54	31.770	72	36	36	30.291		33.249	145	31.770	60	30	30		30.291	60
1 1/8	11	2.3091	37.897	54	36.418	72	36	36	34.939		37.897	145	36.418	60	30	30		34.939	60
1 1/4	11	2.3091	41.91 O	54	40.431	72	36	36	38.952		41.910	145	40.431	65	30	35		38.952	65
1 1/2	11	2.3091	47.803	54	46.324	72	36	36	44.845		47.803	145	46.324	65	30	35		44.845	65
1 3/4	11	2.3091	53.746	54	52.267	72	36	36	50.788		53.746	145	52.267	65	30	35		50.788	65
2	11	2.3091	59.614	54	58.135	72	36	36	56.656		59.614	150	58.135	75	35	40		56.656	75
2 1/4	11	2.3091	65.710	65	64.231	87	43	44	62.752		UT: upper deviation LT: lower deviation								
2 1/2	11	2.3091	75.184	65	73.705	87	43	44	72.226										
2 3/4	11	2.3091	81.534	65	80.055	87	43	44	78.576										
3	11	2.3091	87.884	65	86.405	87	43	44	84.926										
3 1/2	11	2.3091	100.330	65	98.851	87	43	44	97.372										
4	11	2.3091	113.030	65	111.551	87	43	44	110.072										

Comparison of the thread limit of parallel internal pipe taps

Unit: mm

Size	Number of Threads (per inch)	Pitch (mm)	Thread Limit of ISO (G)								Thread Limit of Appendix of PF									
			Major Dia		Pitch Dia				Minor Dia		Major Dia		Pitch Dia				Minor Dia			
			Basic Size (mm)	LT (+)	Basic Size (mm)	UT (+)	LT (+)	Tolerance	Basic Size (mm)	UT	Basic Size (mm)	LT (+)	Basic Size (mm)	UT (+)	LT (+)	Tolerance	Basic Size (mm)	UT (+)	LT (-)	
1/16	28	0.9071	7.723	43	7.142	14	43	29	6.561	Not Specified	-						-			
1/8	28	0.9071	9.728	43	9.147	14	43	29	8.566		9.728	+10	50	9.147	30	50	20	8.566	+10	50
1/4	19	1.3368	13.157	63	12.301	21	63	42	11.445		13.157	+5	75	12.301	50	75	25	11.445	+5	75
3/8	19	1.3368	16.662	63	15.806	21	63	42	14.950		16.662	+5	75	15.806	50	75	25	14.950	+5	75
1/2	14	1.8143	20.955	86	19.793	29	86	57	18.631		20.955	-25	115	19.793	85	115	30	18.631	-225	115
3/4	14	1.8143	26.441	86	25.279	29	86	57	24.117		26.441	-25	115	25.279	85	115	30	24.117	-25	115
1	11	2.3091	33.249	109	31.770	37	109	72	30.291		33.249	-50	150	31.770	120	150	30	30.291	-50	150
1 1/4	11	2.3091	41.910	109	40.431	37	109	72	38.952		41.910	-50	150	40.431	115	150	35	38.952	-50	150
1 1/2	11	2.3091	47.803	109	46.324	37	109	72	44.845		47.803	-50	150	46.324	115	150	35	44.845	-50	150
2	11	2.3091	59.614	109	58.135	37	109	72	56.656		59.614	-45	145	58.135	105	145	40	56.656	-45	145
2 1/2	11	2.3091	75.184	130	73.705	43	130	87	72.226		UT: upper deviation LT: lower deviation									
3	11	2.3091	87.884	130	86.405	43	130	87	84.926											
4	11	2.3091	113.030	130	111.551	43	130	87	110.072											

17. Taps for Pipe Threads

Intro

American Pipe Thread Taps

SP

American standard pipe thread has various types. We show their symbols and engagement of threads as follows.

Pair groups of external thread and internal thread.

SL

Standard	Description	Internal Thread	Mating Thread	External Thread	Mating Thread
Pipe Threads, General Purpose (ANSI/ASME B1.20.1)	American Standard Taper Pipe Thread for General Use	NPT	NPT	NPT	NPT NPSC
	American Standard Straight Pipe Thread in Pipe Couplings	NPSC	NPT	-	-
	American Standard Taper Pipe Threads for Railing Joints	NPTR	NPTR	NPTR	NPTR
	American Standard Straight Pipe Thread for Free-Fitting Mechanical Joints for Fixtures	NPSM	NPSM	NPSM	NPSM
	American Standard Straight Pipe Thread for Loose-Fitting Mechanical Joints with Locknuts	NPSL	NPSL	NPSL	NPSL
	American Standard Straight Pipe Threads for Loose-Fitting Mechanical Joints for Hose Couplings	NPSH	NPSH	NPSH	NPSH
Dryseal Pipe Threads (ANSI B1.20.3)	Dryseal American Standard Taper Pipe Thread	NPTF	NPTF PTF-SAE-SHORT	NPTF	NPTF, NPSF, NPSI PTF-SAE-SHORT
	Dryseal SAE Short Taper Pipe Thread	PTF-SAE-SHORT	NPTF	PTF-SAE-SHORT	NPTF NPSI
	Dryseal American Standard Fuel Internal Straight Pipe Thread	NPSF	NPTF	-	-
	Dryseal American Standard Intermediate Internal Straight Pipe Thread	NPSI	NPTF PTF-SAE-SHORT	-	-

Note: These symbols correspond to the name of American pipe thread.

HAND
TAPS

These threads are

- (1) Thread angle is 60°
- (2) Taper of Taper Thread is 3/4" per foot.
- (3) Fundamental height of triangle : H=Height of triangle thread profile H=0.866025P
- (4) The difference between American Standard Pipe Thread for general use and Dryseal American Standard Pipe
 - Crests and roots truncation of thread is different.
 - The length of engagement for pipe thread is different by types.
 - With regard to standard, Dryseal American Standard Pipe Thread is available in right hand.

EG (STI)

In accordance with ANSI B 94.9, 4 types of pipe thread are specified in American Pipe Thread Standard.
Please refer to next page about the relation between taps and threads and about thread tolerance.

SPECIAL
THREADS,
GAUGES

THREAD
MILLS

DIES

CENTER
DRILLS

Technical
info

Classification of American pipe thread taps

Standard	Symbol	Class	Material	Threads to be cut	Range
Straight Pipe Thread Tap	NPS	Ground Thread	HSS	NPSC, NPSM	-1
Dryseal Straight Pipe Thread Tap	NPSF	Ground Thread	HSS	NPSF	-3/4
Taper Pipe Thread Tap	NPT	Ground Thread	HSS	NPT	-2
Dryseal Taper Pipe Thread Tap	NPTF	Ground Thread	HSS	NPTF	-2

Thread limit of American Pipe Thread Taps
Straight pipe thread taps for (NPS) G Class

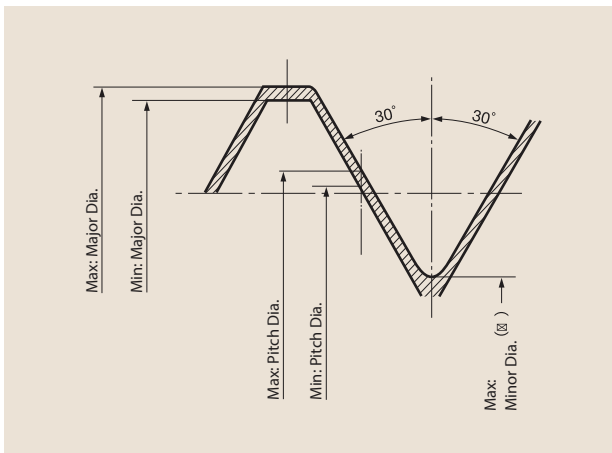

Size	Major diameter			Pitch diameter			Minor diameter*
	Max.	Min.	Tolerance	Max.	Min.	Tolerance	Max.
NPS 1/8 - 27	10.241	10.216	0.025	9.527	9.515	0.012	M - 0.053
NPS 1/4 - 18	13.606	13.582	0.024	12.542	12.530	0.012	M - 1.019
NPS 3/8 - 18	17.045	17.021	0.024	15.981	15.969	0.012	M - 1.019
NPS 1/2 - 14	21.226	21.202	0.024	19.840	19.828	0.012	M - 1.334
NPS 3/4 - 14	26.560	26.536	0.024	25.186	25.162	0.024	M - 1.334
NPS 1 - 11.5	33.215	33.176	0.037	31.526	31.502	0.024	M - 1.644

*Above dimensions change depending on actually measured

17. Taps for Pipe Threads

Intro

Taper pipe thread taps (NPT) G Class

SP

SL

PO

ST

ROLL

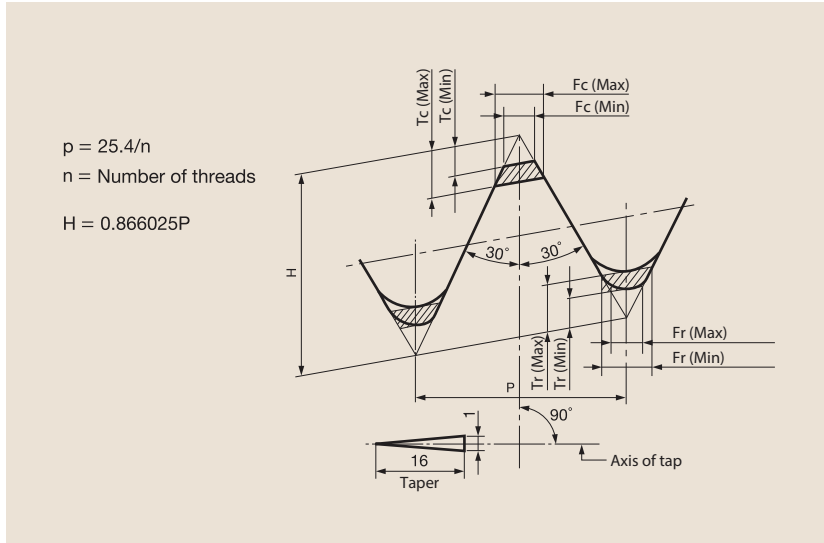

Unit: mm

CARBIDE

LONG

HAND
TAPS

EG (STI)

SPECIAL
THREADS,
GAUGES

THREAD
MILLS

DIES

CENTER
DRILLS

Size	Crest				Root			
	Max.	Tc Min.	Max.	Fc Min.	Max.	Tr Min.	Max.	Fr Min.
NPT 1/6 - 27	68	32	78	37	80	32	82	37
NPT 1/8 - 27	68	32	78	37	80	32	82	37
NPT 1/4 - 18	92	48	106	56	101	48	116	56
NPT 3/8 - 18	92	48	106	56	101	48	116	56
NPT 1/2 - 14	106	61	122	71	118	61	136	71
NPT 3/4 - 14	106	61	122	71	118	61	136	71
NPT 1 - 11.5	120	74	138	85	134	74	136	85
NPT 1 1/4 - 11.5	120	74	138	85	134	74	154	85
NPT 1 1/2 - 11.5	120	74	138	85	134	74	154	85
NPT 2 - 11.5	120	74	138	85	134	74	154	85
NPT 2 1/2 - 8	147	105	169	122	173	105	199	122
NPT 3 - 8	147	105	169	122	173	105	199	122

Technical
info

Thread limit of Dryseal American Pipe Thread Taps
Straight pipe thread taps (NPSF) G Class

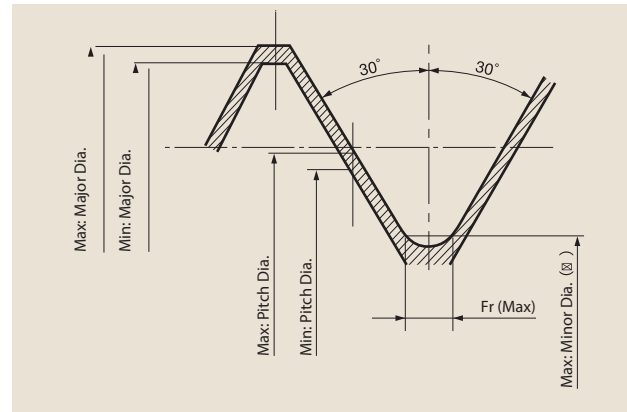
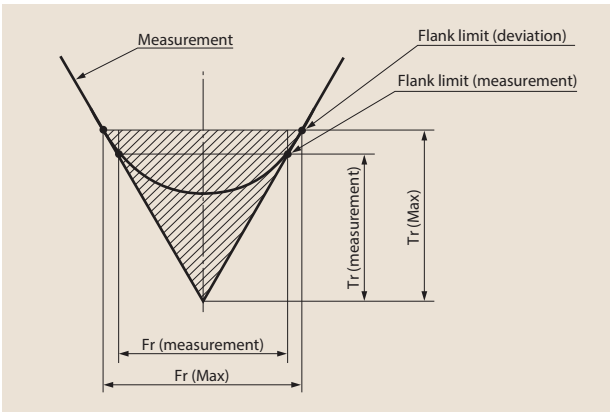

Size	Major diameter			Pitch diameter			Minor diameter*		
	Max.	Min.	Tolerance	Max.	Min.	Tolerance	Max.	Fr (Max.)	Tr (Max.)
NPSF 1/16 - 27	7.665	7.641	0.024	7.053	7.041	0.012	M - 0.638	0.101	0.086
NPSF 1/8 - 27	10.012	9.988	0.024	9.400	9.388	0.012	M - 0.638	0.101	0.086
NPSF 1/4 - 18	13.332	13.308	0.024	12.354	12.342	0.012	M - 1.004	0.127	0.109
NPSF 3/8 - 18	16.771	16.747	0.024	15.793	15.781	0.012	M - 1.004	0.127	0.109
NPSF 1/2 - 14	20.929	20.905	0.024	19.601	19.589	0.012	M - 1.354	0.127	0.109
NPSF 3/4 - 14	26.276	26.251	0.025	24.947	24.936	0.011	M - 1.354	0.127	0.109

*Above dimensions change depending on actually measured

Taper pipe thread taps (NPTF) G Class

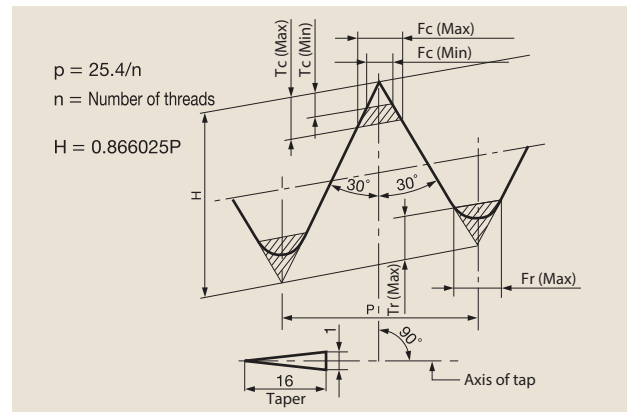
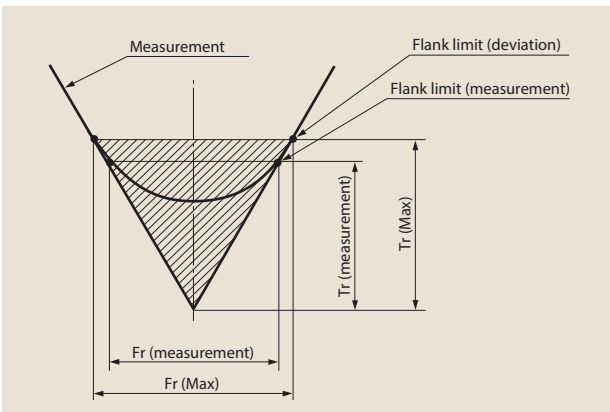

Unit: mm

Size	Crest				Root	
	Max.	Tc Min.	Max.	Min.	Tr Max.	Fr Min.
NPTF 1/16 - 27	110	89	127	103	86	101
NPTF 1/8 - 27	110	89	127	103	86	101
NPTF 1/4 - 18	132	110	152	127	109	125
NPTF 3/8 - 18	132	110	152	127	109	125
NPTF 1/2 - 14	131	109	151	126	108	124
NPTF 3/4 - 14	131	109	151	126	108	124
NPTF 1 - 11.5	176	133	203	154	132	152
NPTF 1 1/4 - 11.5	176	133	203	154	132	152
NPTF 1 1/2 - 11.5	176	133	203	154	132	152
NPTF 2 - 11.5	176	133	203	154	132	152

18. Selecting different tap holder combinations by machine feed system

Intro

SP

The function of machine feed systems

SL

Fully synchronous feed (Rigid) tapping system

Spindle revolution and machine feed are synchronized, a perfect thread lead and feed per revolution are realized.

PO

ST

Feed by lead screws

A better-feed condition is realized because the tap is fed by a master lead screw shaft that has the same thread lead as this tap.

ROLL

CARBIDE

Feed by gear

The tap is fed at the same thread lead by a combinations of gears. This creates a better-feed to thread lead condition.

LONG

HAND TAPS

Asynchronous feed system

Best used when the spindle rotation and the machine feed are set independently, especially, if the machine feed value cannot be accurately predicted to be that of the tap thread lead.

EG (STI)

SPECIAL THREADS, GAUGES

Hydraulic or Pneumatic pressure feed system

Feed is controlled by a pressure regulation system which normally results in an inaccurate feed per revolution compared to the tap thread lead.

THREAD MILLS

DIES

Manual feed

Feed is controlled by operator which is difficult to keep a stable amount of feed per revolution.

CENTER DRILLS

Technical info

Holder aspects

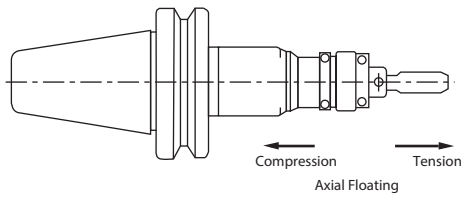

Spring direction

Completely rigid holder type

The tap is held with no axial or radial adjustment in the collet and holder.

Adjustable spring floating holder (Tension & Compression)

Machine feed and tap's thread lead errors are corrected by two types of spring system in the holder, the axial tension direction of the tap and the axial compression direction of the tap.

Characteristics of tap self-guiding behavior

r =tap's radius, s =thread relief, t =margin width

Eccentric thread relief (no width of margin)

s =thread relief

r =tap's radius

Tap characteristics; high cutting performance and machining performance, with little to no self-guiding features. Operation; A fully synchronous machining system with fixed rigid holder is needed.
Example: "High speed tapping" and "fully synchronous tapping."

Con-eccentric thread relief (margin and thread relief)

t =margin width
 s =thread relief

r =tap's radius

Tap; High level of self-guidance due to suitable tap diameter margin and thread relief. The combination of nice portion of margin and chamfer relief helps to make appropriate tap

Concentric (No relief)

r =tap's radius

Tap; A full thread land stays in contact with the thread major diameter at all times. Tap has no thread relief on major diameter, creating a high level of self-guidance even with unbalanced feeding conditions.

19. The mechanism for a tap to cut oversize on an internal thread

Intro

1. Run out, misalignment and tap doesn't cut perpendicular into holes → Over-cutting at radial direction

SP

SL

PO

ST

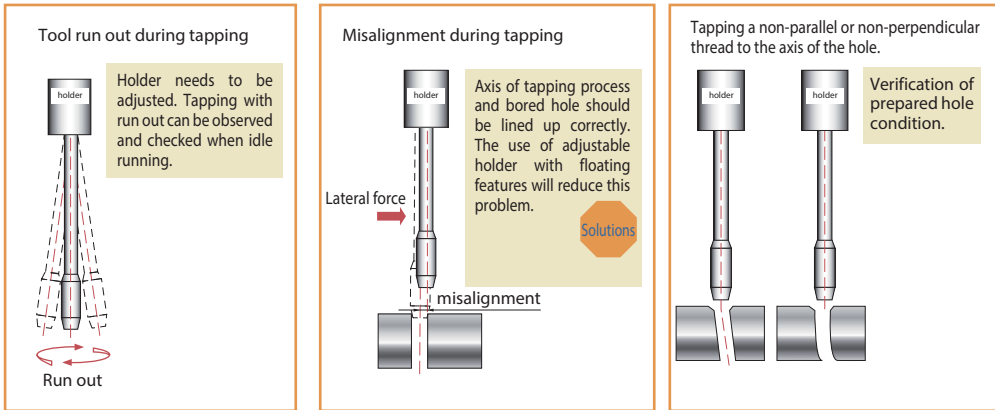

Excessive cutting in radial direction causes oversized internal threads. Since tapping proceeds along bored hole, in the depth of hole, oversize cutting is minimized, that is, oversize cutting in the beginning of the hole and normal cutting in the depth of the hole.

ROLL

CARBIDE

LONG

HAND TAPS

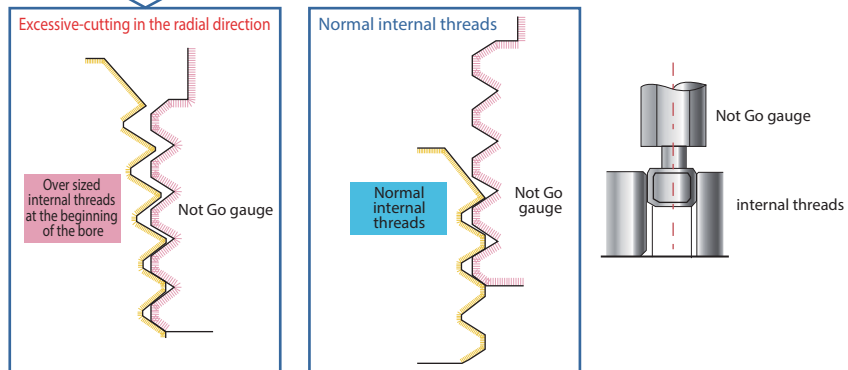

2. Using a tap not suitable for the operation or a tap with dull cutting edge may cause galling and result in over-cutting → Over-cutting caused by galling and excess cutting

EG (STI)

SPECIAL THREADS, GAUGES

THREAD MILLS

DIES

CENTER DRILLS

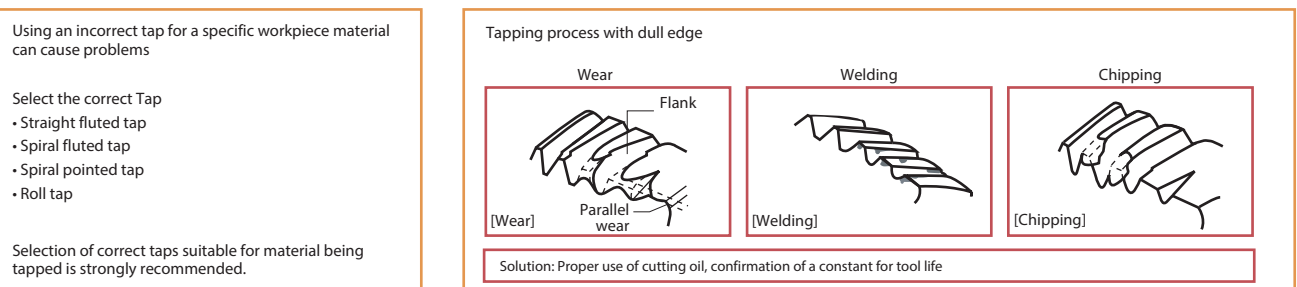

Torn threads occur on the thread flanks. If this situation gets worse, there occur large thread collapses or incomplete threads finally bringing out oversized internal threads. Depending on the condition of collapsed threads such trouble tends to occur discontinuously as NOT-GO gauge enters. Special attention needs to be taken so that random inspection should not miss this kind of trouble.

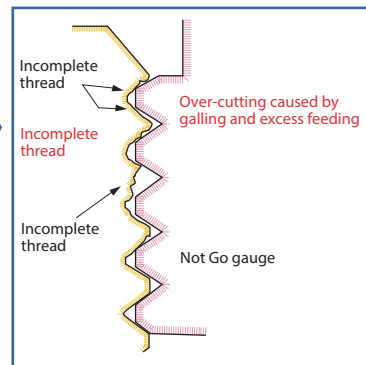

Technical info

3. Tapping with an improper feed condition → over-cutting at axial direction

Process of over-cutting due to excessive feed

- ① With cutting edge b1, cutting starts.
- ② Position between workpiece and tap after the tap rotates 1 turn.
- ③ Position between workpiece and tap after the tap rotates 2 turns.
- ④ The position between workpiece and tap after 3 rotations of tap.

Solutions

Feed adjustment is strongly recommended.

- (Use fully synchronous feed system and fixing holder)

When using machines that do not have the synchronous feed system, such as drilling machine.

- Adjust the correct weight balance of main spindle properly.
- Use an axial/radial floating holder for adjustment.

Excessive-cutting of the thread with excessive feeding

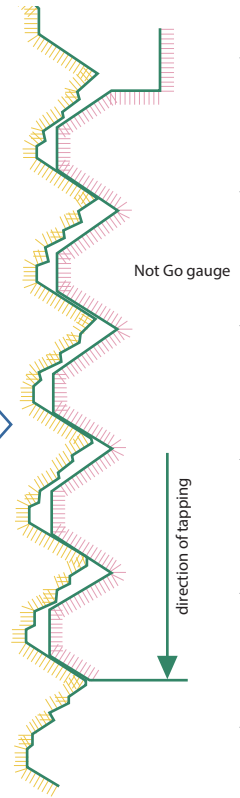

Over-cutting of the thread by too slow feeding
Process opposite of excessive feeding factors causes extra material cutting at back flank.

over-cutting during tapping

- ① The tap mounting condition in the holder.
- ② The condition of bored hole.
- ③ The cutting oil selection.
- ④ Incorrect adjustment of feed balance.
- ⑤ Selection of the tap depending on material being cut.

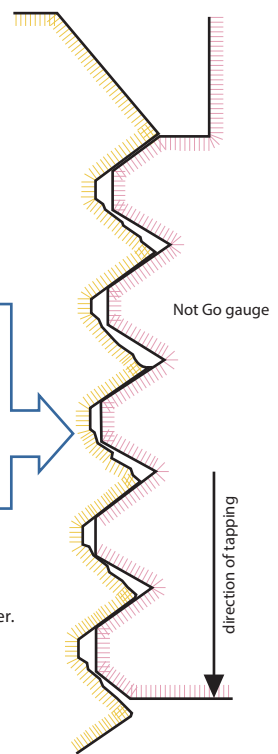

- Intro
- SP
- SL
- PO
- ST
- ROLL
- CARBIDE
- LONG
- HAND TAPS
- EG (STI)
- SPECIAL THREADS, GAUGES
- THREAD MILLS
- DIES
- CENTER DRILLS
- Technical info

20. Troubleshooting

Intro

Troubles		Breakage			Excessive wear	
Check point		Prevent excessive cutting torque	Prevent clogging of chips	Tap	Workpiece	Tap
Segments						
SL	Hardness	· Use workpiece which has regular structure and hardness.			· Use workpiece which has regular structure and hardness.	
	Shape	· Pay attention to tapping position and material thickness.			· Pay attention to tapping position and material thickness.	
PO	Workpiece	· Provide bigger bored holes. · Prevent work hardening.			· Provide bigger bored holes. · Provide countersinking on hole entrance. · Prevent work hardening	
ST		Bored hole	· Provide deeper bored hole. · Prevent slanting of hole.			
ROLL	Machine	· Avoid inconsistent feed. · Adjust feed stroke				
CARBIDE	Jigs, Holders	· Use holder floating type. · Use tap holder with torque limiter.				
LONG	Cutting condition	· Reduce cutting speed			· Reduce cutting speed	
HAND TAPS	Lubricant	· Use cutting oil which prevents cold welding. · Use cutting oil.			· Provide proper timing for changing or filling-up of cutting oil. · Prevent mixing of different type of oil. · Use cutting oil which prevents cold welding. · Use cutting oil. · Adjust flow of cutting oil and method of lubrication.	
EG (STI)	On process		· Remove unnecessary chips during tapping. · Provide bigger space for chips disposal.			
SPECIAL THREADS, GAUGES	Tap	Selection		· Use PO tap (through hole). · Use SP tap (blind hole). · Use roll tap.		
THREAD MILLS		Design	· Provide bigger chiproom.	· Change material of taps. · Provide proper hardness on taps.		· Use serial set tap. · Change material of taps. · Provide proper hardness on taps.
DIES			· Reconsider length of cutting chamfer. · Use set tap.			· Reconsider length of cutting chamfer. · Provide nitride on taps.
CENTER DRILLS		Regrind	· Be careful about burning during re-sharpening. · Provide proper land.			· Be careful about burning during re-sharpening. · Increase re-sharpening frequency.

Technical info

Undersize cutting of internal thread			Bad surface, surface damaged		
Improve cutting performance	Selection and design of tap	Work material	Improve cutting performance	Prevent welding	Check cutting condition
		· Check workmaterial.			· Use workpiece which has regular structure and hardness.
		· Pay attention to tapping position and material thickness.			· Pay attention to tapping position and material thickness.
· Adopt bigger bored hole. · Prevent work hardening of material.					
			· Prevent work hardening.	· Provide bigger bored holes.	· Prevent slanting of hole.
					· Feed according to pitch.
					· Use floating type holder. · Prevent vibration of tap. · Prevent centering-off with work piece.
			· Reduce cutting speed		
			· Provide proper timing for changing or filling-up of cutting oil. · Prevent mixing of different type of oil. · Use cutting oil which prevents cold welding. · Use cutting oil. · Adjust flow of cutting oil and method of lubrication.		
				· Remove unnecessary chips during tapping.	
· Provide Nitride on taps.	· Use oversized taps.		· Use spiral pointed taps (for through hole).	· Provide oxide coating on taps.	· Use oil hole taps.
· Provide larger cutting angle.	· Adjust relief angle on cutting chamfer. · Provide thread relief.		· Provide larger cutting angle. · Adjust relief angle on cutting chamfer. · Provide smaller margin.	· Change of no. of flutes on taps.	· Reconsider length of cutting chamfer.
· Increase re-sharpening frequency.			· Increase re-sharpening frequency.	· Provide better surface finishing on flutes.	
			· Provide precise re-sharpening.		

SP

SL

PO

ST

ROLL

CARBIDE

LONG

HAND TAPS

EG (STI)

SPECIAL THREADS, GAUGES

THREAD MILLS

DIES

CENTER DRILLS

Technical info

Intro

Troubles		Over-cutting of internal thread						
Check point		Prevent uneven in feed of tap	Prevent over cutting on thread	Prevent welding	Check cutting condition	Prevent unbalance on entering		
Segments								
SL	Hardness							
	Shape							
PO	Workpiece			· Provide bigger bored holes.	· Provent slanting of hole.	· Provide countersinking on the hole entrance.		
ST							Bored hole	
ROLL	Machine	· Adjust the feed. · Feed according to pitch.						
CARBIDE	Jigs, Holders				· Use floating type holder.	· Prevent vibration of tap. · Provent centering-off with work piece. · Use floating type holder.		
LONG	Cutting condition			· Reduce cutting speed.				
HAND TAPS	Lubricant			· Use lubricant which prevents cold welding. · Check the viscosity.				
EG (STI)	On process							
SPECIAL THREADS, GAUGES	Tap			· Provide oxide surface treatment. · Use tap with oil hole.				
THREAD MILLS				Design	· Provide small cutting angle. · Adjust chamfer relief angle. · Check the width of thread margin.	· Provide short thread length.	· Reconsider number of flutes to tap.	· Reconsider length of cutting chamfer.
DIES				Regrind	· Remove burrs on teeth after re-grinding. · Provide proper land.		· Provide precise re-sharpening.	· Avoid vibration.
CENTER DRILLS								

Technical info

Chipping			Tapping operation		
Prevent clogging of chips	Prevent excessive cutting torque	Improve tapping method	Tap	Prevent clogging of chips	Tap
	<ul style="list-style-type: none"> Use workpiece material which has regular structure and hardness. 				
		<ul style="list-style-type: none"> Pay attention to tapping position and material thickness. 		<ul style="list-style-type: none"> If possible, use finer pitch tap or shorter tapping length. 	
<ul style="list-style-type: none"> Provide deeper tapping hole (blind hole). 	<ul style="list-style-type: none"> Provide bigger bored hole. Prevent work hardening. 	<ul style="list-style-type: none"> Prevent slanting of holes. 		<ul style="list-style-type: none"> Provide bigger bored holes. Provide deeper tapping hole (blind hole). 	
<ul style="list-style-type: none"> Provide countersinking on hole entrance. 					
	<ul style="list-style-type: none"> Avoid inconsistent feed. 				
	<ul style="list-style-type: none"> Use tapping holder with torque limiter. 	<ul style="list-style-type: none"> Prevent centering-off with workpiece. Prevent vibration of tap. Use floating type holder. 		<ul style="list-style-type: none"> Prevent centering-off with workpiece. Prevent vibration of axis of tap. Use floating type holder. 	
<ul style="list-style-type: none"> Reduce cutting speed. 				<ul style="list-style-type: none"> Reduce cutting speed. 	
	<ul style="list-style-type: none"> Use lubricant which prevents cold welding. 			<ul style="list-style-type: none"> Check the viscosity. 	
<ul style="list-style-type: none"> Remove unnecessary chips during tapping. Provide bigger space for chip disposal. 				<ul style="list-style-type: none"> Remove unnecessary chips during tapping. Provide bigger space for chip disposal. 	
			<ul style="list-style-type: none"> Use PO tap (through hole). Use SP tap (blind hole). Use roll tap. 	<ul style="list-style-type: none"> Use PO tap (through hole). Use SP tap (blind hole). Use roll tap. 	
<ul style="list-style-type: none"> Provide bigger chip room. 			<ul style="list-style-type: none"> Change material of tap. Provide smaller cutting angle. Provide proper hardness. 	<ul style="list-style-type: none"> Provide bigger chip room. Reconsider length of cutting chamfer. Use oil hole tap. Provide shorter thread length to tap. 	
<ul style="list-style-type: none"> Reconsider length of cutting chamfer. Use set tap (Serial or conventional). Adjust relief angle on cutting chamfer. 					
<ul style="list-style-type: none"> Be careful about burning during re-sharpening 					

SP

SL

PO

ST

ROLL

CARBIDE

LONG

HAND TAPS

EG (STI)

SPECIAL THREADS, GAUGES

THREAD MILLS

DIES

CENTER DRILLS

Technical info

Unified Threads

Size		Nominal Dia.		Threads per inch															
Column 1	Column 2	inch	mm	Coarse	Fine	Extra Fine	Constant pitch series												
				UNC	UNF	UNEF	4UN	6UN	8UN	12UN	16UN	20UN	28UN	32UN					
No. 0	No. 1	0.0600	1.524		80														
No. 2		0.0730	1.854	64	72														
	No. 3	0.0860	2.184	56	64														
No. 4		0.0990	2.515	48	56														
No. 5	No. 6	0.1120	2.845	40	48														
		0.1250	3.175	40	44														
No. 8		0.1380	3.505	32	40														
No. 10	No. 12	0.1640	4.166	32	36												UNC		
		0.1900	4.826	24	32													UNF	
1/4	1 1/8	0.2160	5.486	24	28	32											UNEF		
5/16		0.2500	6.350	20	28	32											UNC		
3/8		0.3125	7.938	18	24	32												UNF	
7/16		0.3750	9.525	16	24	32												UNEF	
		0.4375	11.112	14	20	28												UNC	
1/2	1 1/4	0.5000	12.700	13														UNF	
9/16		0.5625	14.288	12														UNEF	
5/8		0.6250	15.875	11														UNC	
3/4		0.6875	17.462																UNF
		0.7500	19.050	10															UNEF
7/8	0.8125	20.638																UNC	
1	0.8750	22.225	9															UNF	
	0.9375	23.812																UNEF	
	1.0000	25.400	8															UNC	
1 1/8	1.0625	26.988																UNF	
	1.1250	28.575	7															UNEF	
	1.1875	30.162																UNC	
1 1/4	1.2500	31.750	7															UNF	
	1.3125	33.338																UNEF	
1 3/8	1.3750	34.925	6															UNC	
	1.4375	36.512																UNF	
1 1/2	1.5000	38.100	6															UNEF	
	1.5625	39.688																UNC	
1 5/8	1.6250	41.275																UNF	
	1.6875	42.862																UNEF	
1 3/4	1.7500	44.450	5															UNC	
	1.8125	46.038																UNF	
1 7/8	1.8750	47.625																UNEF	
	1.9375	49.212																UNC	
2	2.0000	50.800	4.5															UNF	
	2.1250	53.975																UNEF	
2 1/4	2.2500	57.150	4.5															UNC	
	2.3750	60.325																UNF	
2 1/2	2.5000	63.500	4															UNEF	
	2.6250	66.675																UNC	
2 3/4	2.7500	69.850	4															UNF	
	2.8750	73.025																UNEF	
3	3.0000	76.200	4															UNC	
	3.1250	79.375																UNF	
3 1/4	3.2500	82.550	4															UNEF	
	3.3750	85.725																UNC	
3 1/2	3.5000	88.900	4															UNF	
	3.6250	92.075																UNEF	
3 3/4	3.7500	95.250	4															UNC	
	3.8750	98.425																UNF	
4	4.0000	101.600	4															UNEF	
	4.1250	104.775																UNC	
4 1/4	4.2500	107.950																UNF	
	4.3750	111.125																UNEF	
4 1/2	4.5000	114.300																UNC	
	4.6250	117.475																UNF	
4 3/4	4.7500	120.650																UNEF	
	4.8750	123.825																UNC	
5	5.0000	127.000																UNF	
	5.1250	130.175																UNEF	
5 1/4	5.2500	133.350																UNC	
	5.3750	136.525																UNF	
5 1/2	5.5000	139.700																UNEF	
	5.6250	142.875																UNC	
5 3/4	5.7500	146.050																UNF	
	5.8750	149.225																UNEF	
6	6.0000	152.400																UNC	

Conversion Table

Threads per inch (25.4mm)	Pitch (mm)
100	0.2540
80	0.3175
72	0.3528
64	0.3969
60	0.4233
56	0.4536
48	0.5292
44	0.5773
40	0.6350
36	0.7056
32	0.7938
28	0.9071
27	0.9407
24	1.0583
20	1.2700
19	1.3368
18	1.4111
16	1.5875
14	1.8143
13	1.9538
12	2.1167
11.5	2.2087
11	2.3091
10	2.5400
9	2.8222
8	3.1750
7	3.6286
6	4.2333
5	5.0800
4.5	5.6444
4	6.3500

SP

SL

PO

ST

ROLL

CARBIDE

LONG

HAND TAPS

EG (STI)

SPECIAL THREADS, GAUGES

THREAD MILLS

DIES

CENTER DRILLS

Technical info

General size list of metric trapezoidal threads

	1.5	2	3	4	5	6	7	8	10	12
Tr 8	1.5									
Tr 9	1.5	2								
Tr 10	1.5	2								
Tr 11		2	3							
Tr 12		2	3							
Tr 14		2	3							
Tr 16		2		4						
Tr 18		2		4						
Tr 20		2		4						
Tr 22			3		5			8		
Tr 24			3		5			8		
Tr 26			3		5			8		
Tr 28			3		5			8		
Tr 30			3			6			10	
Tr 32			3			6			10	
Tr 34			3			6			10	
Tr 36			3			6			10	
Tr 38			3				7		10	
Tr 40			3				7		10	
Tr 42			3				7		10	
Tr 44			3				7			12
Tr 46			3					8		12
Tr 48			3					8		12

22. Basic Profile of Threads

Intro

SP

SL

PO

ST

ROLL

CARBIDE

LONG

HAND TAPS

EG (STI)

SPECIAL THREADS, GAUGES

THREAD MILLS

DIES

CENTER DRILLS

Metric Screw Threads (M, MF)

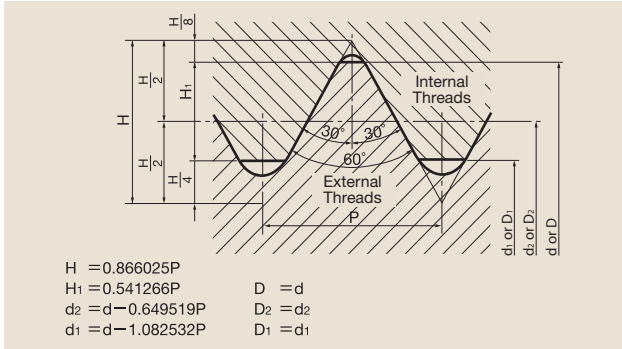

Unified Screw Threads (UN)

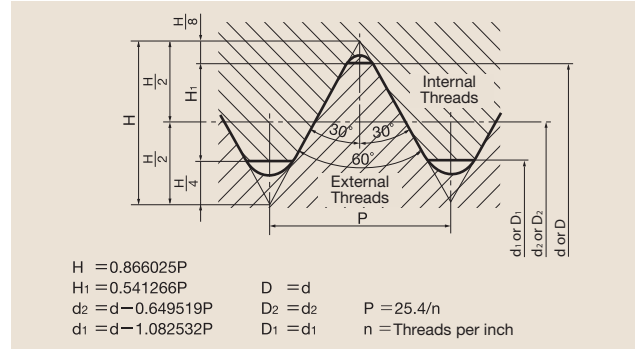

Whitworth Screw Threads (BSW)

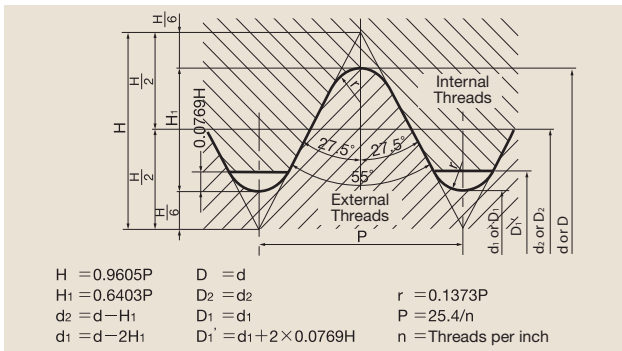

Screw Threads for Sewing Machine (SM)

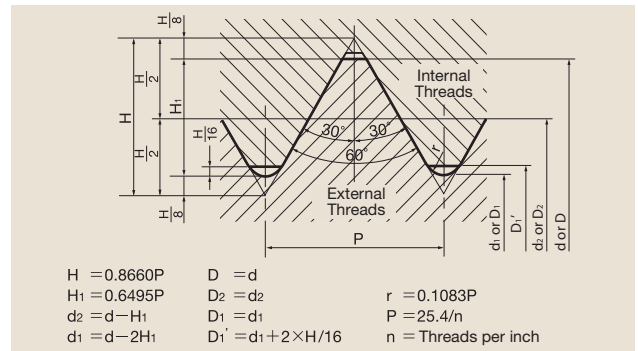

Miniature Screw Threads (S)

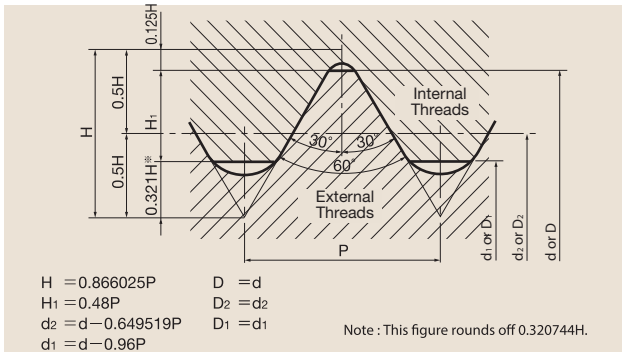

Parallel Pipe Threads (G-BSP)

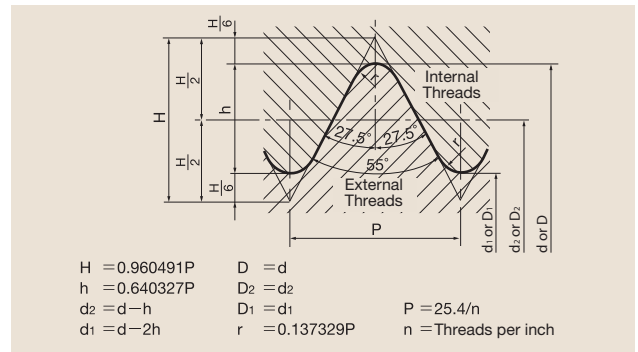

Taper Pipe Threads (Rc-BSPT)

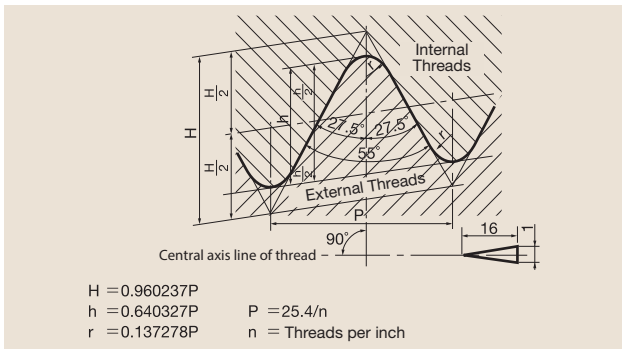

Parallel Internal Pipe Threads (Rp-BSPP)

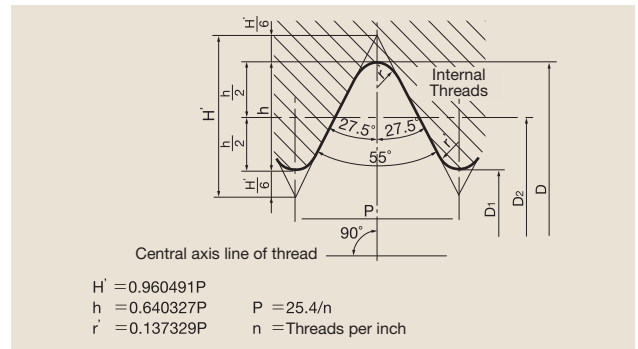

Technical info

American Standard Taper Pipe Threads (NPT)

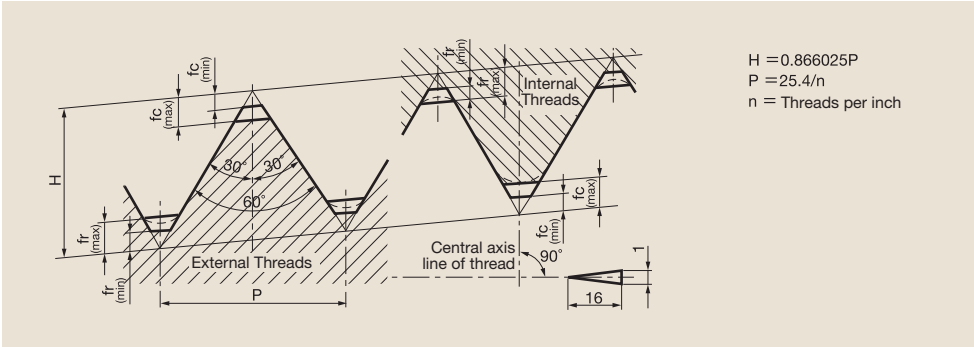

Truncation

Unit: mm

Threads per inch	Section	$fc = fr$
27	Max.	0.096P
	Min.	0.033P
18	Max.	0.088P
	Min.	0.033P
14	Max.	0.078P
	Min.	0.033P
11.5	Max.	0.073P
	Min.	0.033P
8	Max.	0.062P
	Min.	0.033P

SP

SL

PO

Dryseal American Standard Taper Pipe Threads (NPTF)

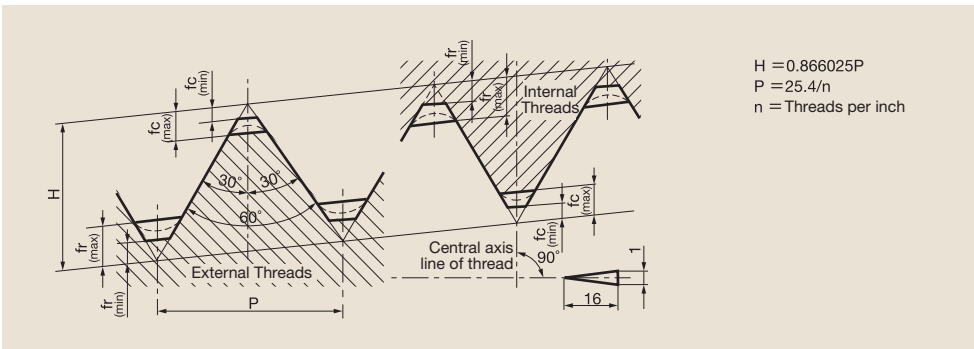

Truncation

Unit: mm

Threads per inch	Section	fc	fr
27	Max.	0.094P	0.140P
	Min.	0.047P	0.094P
18	Max.	0.078P	0.109P
	Min.	0.047P	0.078P
14	Max.	0.060P	0.085P
	Min.	0.036P	0.060P
11.5	Max.	0.060P	0.090P
	Min.	0.040P	0.060P
8	Max.	0.055P	0.076P
	Min.	0.042P	0.055P

ST

ROLL

CARBIDE

Metric Trapezoidal Screw Threads (Tr)

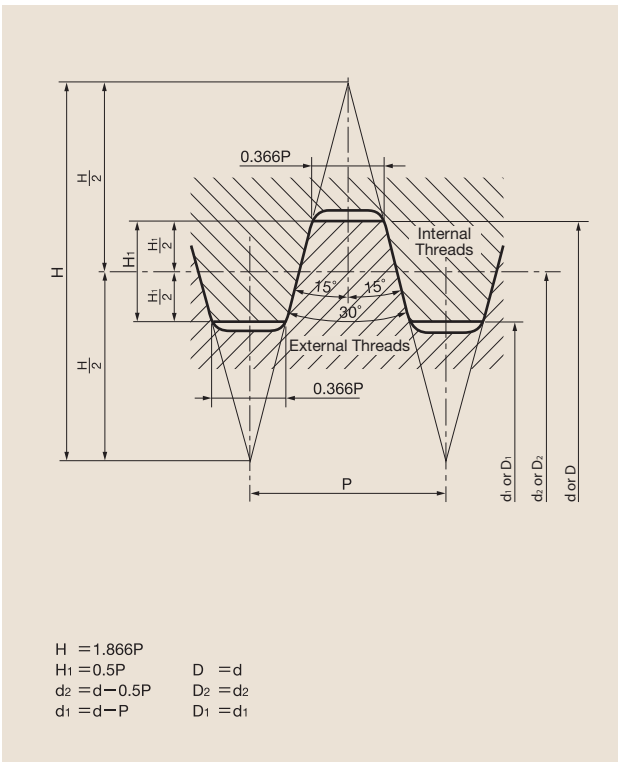

29° Trapezoidal Screw Threads (29 Tr)

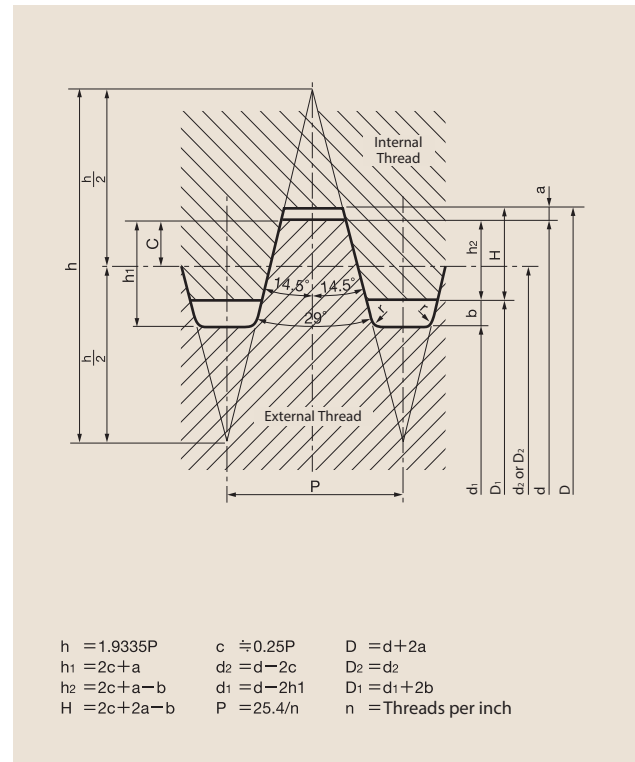

LONG

HAND TAPS

EG (STI)

SPECIAL THREADS, GAUGES

THREAD MILLS

DIES

CENTER DRILLS

Technical info

22. Basic Profile of Threads

Intro

SP

SL

PO

ST

ROLL

CARBIDE

LONG

HAND TAPS

EG (STI)

SPECIAL THREADS, GAUGES

THREAD MILLS

DIES

CENTER DRILLS

Technical info

Thick Steel Conduit Threads (CTG)

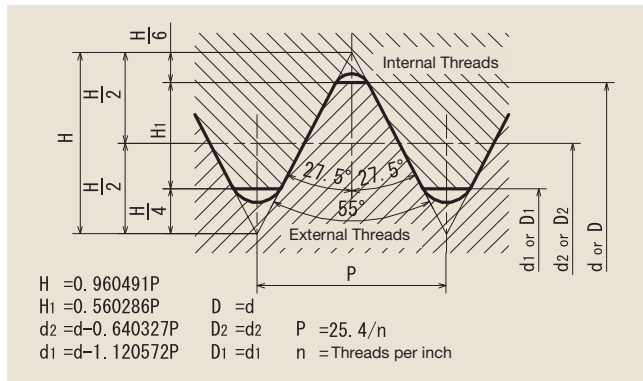

Steel Conduit Threads (CTC)

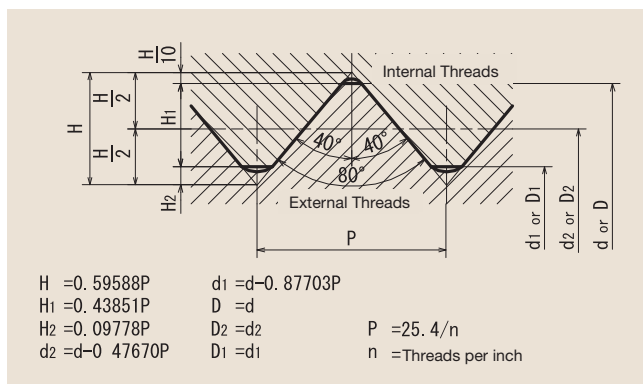

Bicycle Threads (BC)

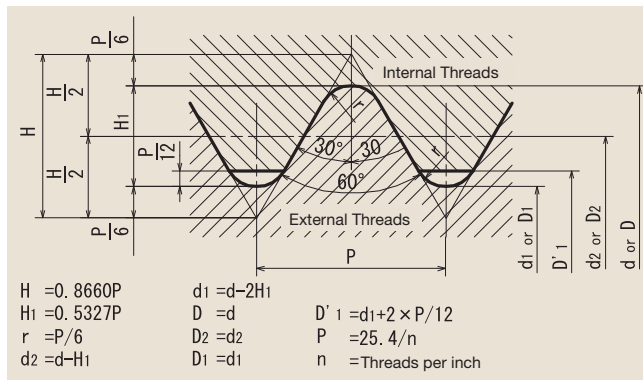

Tire Valve Threads (TV), Bicycle Tire Valve Threads (CTV)

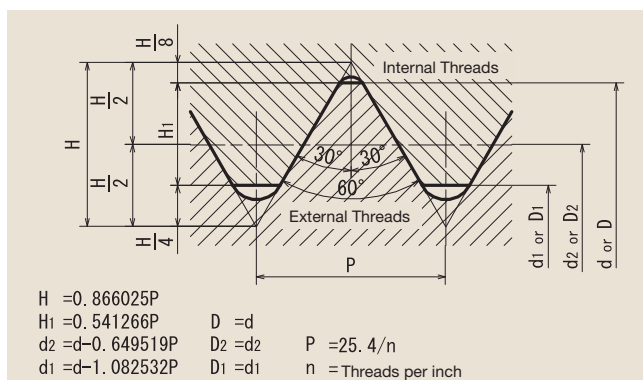

23. Symbols for Standard Threads

ISO

Thread symbol	Kinds of thread	Related Standard
M	ISO Metric threads	ISO 261
UNC	ISO Unified threads, coarse series	ISO 263
UNF	ISO Unified threads, fine series	ISO 263
UNEF	ISO Unified threads, extra fine series	ISO 263
UN	ISO Unified threads, constant pitch series	ISO 263
G	Parallel pipe threads	ISO 228/1
Rp	Parallel internal pipe threads	ISO 7/1
Rc	Taper internal pipe threads	ISO 7/1
R	Taper external pipe threads	ISO 7/1
S	ISO Miniature screw threads	ISO 1501
Tr	ISO Metric trapezoidal screw threads	ISO 2902
UNJC	Aerospace - UNJ threads (coarse)	ISO 3161
UNJF	Aerospace - UNJ threads (fine)	ISO 3161
UNJEF	Aerospace - UNJ threads (extra fine)	ISO 3161
UNJ	Aerospace - UNJ threads (constant pitch series)	ISO 3161
MJ	Aerospace - MJ threads	ISO 5855
GL	Glass container threads	ISO 1115
V	Tire valve threads	ISO 4570/1-3

Japan

Thread symbol	Kinds of thread	Related Standard
M	Metric screw threads	JIS B 0205-1 - 0205-4
S	Miniature screw threads	JIS B 0201
UNC	Unified threads, Coarse series	JIS B 0206
UNF	Unified threads, Fine series	JIS B 0208
Tr	Metric Trapezoidal screw threads	JIS B 0216
R	Taper external pipe threads	JIS B 0203 (JIS main book)
Rc	Taper internal pipe threads	JIS B 0203 (JIS main book)
Rp	Parallel internal pipe threads	JIS B 0203 (JIS main book)
G	Parallel pipe threads	JIS B 0202 (JIS main book)
PF	Parallel pipe threads	JIS B 0202 (JIS Appendix)
PT	Taper pipe threads	JIS B 0203 (JIS Appendix)
PS	Parallel internal pipe threads	JIS B 0203 (JIS Appendix)
CTC	Screw threads for rigid metal thin-walled conduit and fitting	JIS C 8305
CTG	Screw threads for rigid metal thick-walled conduit and fitting	JIS C 8305
BC	Cycle threads	JIS B 0225
SM	Screw threads for sewing machine	JIS B 0226 (2001.2.20 repeal)
E	Electric socket and lamp-base threads	JIS C 7709
V	Tire valve threads of automobile	JIS D 4207
CTV	Tire valve threads of cycle	JIS D 9422

Intro

SP

SL

PO

ST

ROLL

CARBIDE

LONG

HAND
TAPS

EG (STI)

SPECIAL
THREADS,
GAUGESTHREAD
MILLS

DIES

CENTER
DRILLSTechnical
info

23. Symbol for Standard Threads

Intro

America

SP

SL

PO

ST

ROLL

CARBIDE

LONG

HAND
TAPS

EG (STI)

SPECIAL
THREADS,
GAUGES

THREAD
MILLS

DIES

CENTER
DRILLS

Thread symbol	Kinds of thread	Related Standard
UN	Unified inch screw threads	ANSI B 1.1
UNC/UNRC	Unified coarse thread series	ANSI B 1.1
UNF/UNRF	Unified fine thread series	ANSI B 1.1
UNEF/UNREF	Unified extra-fine thread series	ANSI B 1.1
4UN/4UNR	Unified constant-pitch series with 4-threads	ANSI B 1.1
6UN/6UNR	Unified constant-pitch series with 6-threads	ANSI B 1.1
8UN/8UNR	Unified constant-pitch series with 8-threads	ANSI B 1.1
12UN/12UNR	Unified constant-pitch series with 12-threads	ANSI B 1.1
16UN/16UNR	Unified constant-pitch series with 16-threads	ANSI B 1.1
20UN/20UNR	Unified constant-pitch series with 20-threads	ANSI B 1.1
28UN/28UNR	Unified constant-pitch series with 28-threads	ANSI B 1.1
32UN/32UNR	Unified constant-pitch series with 32-threads	ANSI B 1.1
UNS/UNRS	Unified threads of special diameters, pitches and lengths of engagement	ANSI B 1.1
NR	American National thread with a 0.108p to 0.144p controlled root radius	MIL-B-7838
Acme	Acme screw threads	ANSI B 1.5
Stub-Acme	Stub Acme screw threads	ANSI B 1.8
Butt	Buttress inch screw threads	ANSI B 1.9
UNM	Unified miniature thread series	ANSI B 1.10
NC5	Class 5 interference-fit thread	ANSI B 1.12
NPT	American Standard taper pipe threads tor general use	ANSI/ASME B 1.20.1
NPTR	American Standard taper pipe threads tor railing joints	ANSI/ASME B 1.20.1
NPSC	American Standard straight pipe thread in pipe couplings	ANSI/ASME B 1.20.1
NPSL	American standard straight pipe threads for loose-fitting mechanical joints with locknuts	ANSI/ASME B 1.20.1
NPSM	American Standard straight pipe threads for free-fitting mechanical joints for fixture	ANSI/ASME B 1.20.1
NPSH	American Standard straight pipe threads tor loose-fitting mechanical joints for hose couplings	ANSI/ASME B 1.20.1
NPTF	Dryseal American Standard taper pipe threads	ANSI B 1.20.3, 1.20.4
F-PTF	Dryseal fine taper pipe thread series	ANSI B 1.20.3, 1.20.4
PTF-SAE SHORT	Dryseal SAE short taper pipe threads	ANSI B 1.20.3, 1.20.4
PTF-SPL SHORT	Dryseal special short taper pipe threads	ANSI B 1.20.3, 1.20.4
PTF-SPL EXTRA SHORT	Dryseal special extra short taper pipe threads	ANSI B 1.20.3, 1.20.4
SPL-PTF	Dryseal special taper pipe threads	ANSI B 1.20.3, 1.20.4
NPSI	Dryseal American Standard intermediate internal straight pipe threads	ANSI B 1.20.3, 1.20.4
NPSF	Dryseal American Standard fuel internal straight pipe threads	ANSI B 1.20.3, 1.20.4
ANPT	Aeronautical National Form taper pipe threads	MIL-P-7150
NGO	National gas outlet threads	ANSI B 57.1
NGS	National gas straight threads	ANSI B 57.1
NGT	National gas taper threads	ANSI B 57.1
SGT	Special gas taper threads	ANSI B 57.1
NH	Hose coupling and firehose coupling threads	USAS B 2.4
NHR	Hose coupling and firehose coupling threads	USAS B 2.4
NPSH	Hose coupling and firehose coupling threads	USAS B 2.4
AMO	American standard microscope objective threads	ANSI B 1.11

Technical
info

British*

Thread symbol	Kinds of thread	Related Standard
UNS	Unified special series	BS 1580
B.S.W.	British Standard Whitworth coarse threads	BS 84
B.S.F.	British Standard fine threads	BS 84
BSP	British Standard pipe thread (corresponding to R, Re, Rp of ISO)	BS 21, 2779
B.A.	B.A.-Screw threads	BS 93
Acme	General purpose, Acme screw threads	BS 1104
Buttress	Buttress threads	BS 1657
BSC	Cycle threads	BS 811
BSMO	Microscope objective threads	BS 3569
E	Edison screw threads	BS 5042

* We left out the symbols after ISO standard was adopted.

German*

Thread symbol	Kinds of thread	Related Standard
GL	Glass containers thread	DIN 168
S	Buttress thread	DIN 513,2781,20401
Rd	Knuckle thread	DIN 262,3182, 7273, 15403,20400
W	Whitworth-gewinde	DIN 168,477,6630,49301
KS,KT	Screw siles for packages made of Plastics	DIN 6063
E	Edison screw thread	DIN 40400
Pg	Steel conduit thread	DIN 40430
Vg	Automobil tire valve thread	DIN 7756
Gf	Thread for freezing pipes	DIN 4930
Gg	Threads for drill pipe	DIN 4941,20314
HA	Thread for bone screws and nuts	DIN 58810
FG	Bicycle threads	DIN 79012

* We left out the symbols after ISO standard was adopted.

SP

SL

PO

ST

ROLL

CARBIDE

LONG

HAND
TAPS

EG (STI)

SPECIAL
THREADS,
GAUGESTHREAD
MILLS

DIES

CENTER
DRILLSTechnical
info

24. Drill size and recommended hole size for cutting taps

Intro

Metric Threads (M)

Unit: mm

Size	Minor Diameter		Drill Size	Recommended Hole Size
	Max.	Min.		
M 1 × 0.25	0.785	0.729	0.75	0.77
M 1.1 × 0.25	0.885	0.829	0.85	0.87
M 1.2 × 0.25	0.985	0.929	0.95	0.97
M 1.4 × 0.3	1.142	1.075	1.10	1.13
M 1.6 × 0.35	1.321	1.221	1.25	1.30
M 1.7 × 0.35	1.421	1.321	1.35	1.40
M 1.8 × 0.35	1.521	1.421	1.45	1.50
M 2 × 0.4	1.679	1.567	1.60	1.65
M 2.2 × 0.45	1.838	1.713	1.75	1.81
M 2.3 × 0.4	1.979	1.867	1.90	1.95
M 2.5 × 0.45	2.138	2.013	2.10	2.11
M 2.6 × 0.45	2.238	2.113	2.20	2.21
M 3 × 0.5	2.599	2.459	2.50	2.56
M 3.5 × 0.6	3.010	2.850	2.90	2.97
M 4 × 0.7	3.422	3.242	3.30	3.38
M 4.5 × 0.75	3.878	3.688	3.80	3.83
M 5 × 0.8	4.334	4.134	4.20	4.28
M 6 × 1	5.153	4.917	5.00	5.09
M 7 × 1	6.153	5.917	6.00	6.09
M 8 × 1.25	6.912	6.647	6.80	6.85
M 9 × 1.25	7.912	7.647	7.80	7.85
M 10 × 1.5	8.676	8.376	8.50	8.60
M 11 × 1.5	9.676	9.376	9.50	9.60
M 12 × 1.75	10.441	10.106	10.30	10.36
M 14 × 2	12.210	11.835	12.00	12.12
M 16 × 2	14.210	13.835	14.00	14.12
M 18 × 2.5	15.744	15.294	15.50	15.63
M 20 × 2.5	17.744	17.294	17.50	17.63
M 22 × 2.5	19.744	19.294	19.50	19.63
M 24 × 3	21.252	20.752	21.00	21.13
M 27 × 3	24.252	23.752	24.00	24.13
M 30 × 3.5	26.771	26.211	26.50	26.63
M 33 × 3.5	29.771	29.211	29.50	29.63
M 36 × 4	32.270	31.670	32.00	32.12
M 39 × 4	35.270	34.670	35.00	35.12
M 42 × 4.5	37.799	37.129	37.50	37.63
M 45 × 4.5	40.799	40.129	40.50	40.63
M 48 × 5	43.297	42.587	43.00	43.12
M 52 × 5	47.297	46.587	47.00	47.10
M 56 × 5.5	50.796	50.046	50.50	50.60
M 60 × 5.5	54.796	54.046	54.50	54.60
M 64 × 6	58.305	57.505	58.00	58.10
M 68 × 6	62.305	61.505	62.00	62.10
M 70 × 6	64.305	63.505	64.00	64.10
M 72 × 6	66.305	65.505	66.00	66.10
M 76 × 6	70.305	69.505	70.00	70.10
M 80 × 6	74.305	73.505	74.00	74.10
M 85 × 6	79.305	78.505	79.00	79.10
M 90 × 6	84.305	83.505	84.00	84.10
M 95 × 6	89.305	88.505	89.00	89.10
M 100 × 6	94.305	93.505	94.00	94.10

Metric Fine Threads (MF)

Unit: mm

Size	Minor Diameter		Drill Size	Recommended Hole Size
	Max.	Min.		
MF 1 × 0.2	0.821	0.783	0.80	0.81
MF 1.1 × 0.2	0.921	0.883	0.90	0.91
MF 1.2 × 0.2	1.021	0.983	1.00	1.01
MF 1.4 × 0.2	1.221	1.183	1.20	1.21
MF 1.6 × 0.2	1.421	1.383	1.40	1.41
MF 1.7 × 0.2	1.521	1.483	1.50	1.51
MF 1.8 × 0.2	1.621	1.583	1.60	1.61
MF 2 × 0.25	1.785	1.729	1.75	1.77
MF 2.2 × 0.25	1.985	1.929	1.95	1.97
MF 2.3 × 0.25	2.085	2.029	2.05	2.07
MF 2.5 × 0.35	2.221	2.121	2.20	2.20
MF 2.6 × 0.35	2.321	2.221	2.30	2.30
MF 3 × 0.35	2.721	2.621	2.70	2.70
MF 3.5 × 0.35	3.221	3.121	3.20	3.20
MF 4 × 0.5	3.599	3.459	3.50	3.56
MF 4.5 × 0.5	4.099	3.959	4.00	4.06
MF 5 × 0.5	4.599	4.459	4.50	4.56
MF 5.5 × 0.5	5.099	4.959	5.00	5.06
MF 6 × 0.75	5.378	5.188	5.30	5.33
MF 6 × 0.5	5.599	5.459	5.50	5.56
MF 7 × 0.75	6.378	6.188	6.30	6.33
MF 7 × 0.5	6.599	6.459	6.50	6.56
MF 8 × 1	7.153	6.917	7.00	7.09
MF 8 × 0.75	7.378	7.188	7.30	7.33
MF 8 × 0.5	7.599	7.459	7.50	7.56
MF 9 × 1	8.153	7.917	8.00	8.09
MF 9 × 0.75	8.378	8.188	8.30	8.33
MF 10 × 1.25	8.912	8.647	8.80	8.85
MF 10 × 1	9.153	8.917	9.00	9.09
MF 10 × 0.75	9.378	9.188	9.30	9.33
MF 10 × 0.5	9.599	9.459	9.50	9.56
MF 11 × 1	10.153	9.917	10.00	10.10
MF 11 × 0.75	10.378	10.188	10.30	10.33
MF 11 × 0.5	10.599	10.459	10.50	10.56
MF 12 × 1.5	10.676	10.376	10.50	10.60
MF 12 × 1.25	10.912	10.647	10.80	10.85
MF 12 × 1	11.153	10.917	11.00	11.09
MF 12 × 0.5	11.599	11.459	11.50	11.56
MF 14 × 1.5	12.676	12.376	12.50	12.60
MF 14 × 1	13.153	12.917	13.00	13.09
MF 15 × 1.5	13.676	13.376	13.50	13.60
MF 15 × 1	14.153	13.917	14.00	14.09
MF 16 × 1.5	14.676	14.376	14.50	14.60
MF 16 × 1	15.153	14.917	15.00	15.09
MF 17 × 1.5	15.676	15.376	15.50	15.60
MF 17 × 1	16.153	15.917	16.00	16.09
MF 18 × 2	16.210	15.835	16.00	16.12
MF 18 × 1.5	16.676	16.376	16.50	16.60
MF 18 × 1	17.153	16.917	17.00	17.09
MF 20 × 2	18.210	17.835	18.00	18.12
MF 20 × 1.5	18.676	18.376	18.50	18.60

Technical info

24. Drill size and recommended hole size for cutting taps

Unit: mm

Unit: mm

Size	Minor Diameter		Drill Size	Recommended Hole Size
	Max.	Min.		
MF 20 × 1	19.153	18.917	19.00	19.09
MF 22 × 2	20.210	19.835	20.00	20.12
MF 22 × 1.5	20.676	20.376	20.50	20.60
MF 22 × 1	21.153	20.917	21.00	21.09
MF 24 × 2	22.210	21.835	22.00	22.12
MF 24 × 1.5	22.676	22.376	22.50	22.60
MF 24 × 1	23.153	22.917	23.00	23.09
MF 25 × 2	23.210	22.835	23.00	23.12
MF 25 × 1.5	23.676	23.376	23.50	23.60
MF 25 × 1	24.153	23.917	24.00	24.09
MF 26 × 1.5	24.676	24.376	24.50	24.60
MF 27 × 2	25.210	24.835	25.00	25.12
MF 27 × 1.5	25.676	25.376	25.50	25.60
MF 27 × 1	26.153	25.917	26.00	26.09
MF 28 × 2	26.210	25.835	26.00	26.12
MF 28 × 1.5	26.676	26.376	26.50	26.60
MF 28 × 1	27.153	26.917	27.00	27.09
MF 30 × 3	27.252	26.752	27.00	27.13
MF 30 × 2	28.210	27.835	28.00	28.12
MF 30 × 1.5	28.676	28.376	28.50	28.60
MF 30 × 1	29.153	28.917	29.00	29.09
MF 32 × 2	30.210	29.835	30.00	30.12
MF 32 × 1.5	30.676	30.376	30.50	30.60
MF 33 × 3	30.252	29.752	30.00	30.13
MF 33 × 2	31.210	30.835	31.00	31.12
MF 33 × 1.5	31.676	31.376	31.50	31.60
MF 35 × 1.5	33.676	33.376	33.50	33.60
MF 36 × 3	33.252	32.752	33.00	33.13
MF 36 × 2	34.210	33.835	34.00	34.12
MF 36 × 1.5	34.676	34.376	34.50	34.60
MF 38 × 1.5	36.676	36.376	36.50	36.60
MF 39 × 3	36.252	35.752	36.00	36.13
MF 39 × 2	37.210	36.835	37.00	37.12
MF 39 × 1.5	37.676	37.376	37.50	37.60
MF 40 × 3	37.252	36.752	37.00	37.13
MF 40 × 2	38.210	37.835	38.00	38.12
MF 40 × 1.5	38.676	38.376	38.50	38.60
MF 42 × 4	38.270	37.670	38.00	38.12
MF 42 × 3	39.252	38.752	39.00	39.13
MF 42 × 2	40.210	39.835	40.00	40.12
MF 42 × 1.5	40.676	40.376	40.50	40.60
MF 45 × 4	41.270	40.670	41.00	41.12
MF 45 × 3	42.252	41.752	42.00	42.13
MF 45 × 2	43.210	42.835	43.00	43.12
MF 45 × 1.5	43.676	43.376	43.50	43.60
MF 48 × 4	44.270	43.670	44.00	44.12
MF 48 × 3	45.252	44.752	45.00	45.13
MF 48 × 2	46.210	45.835	46.00	46.12
MF 48 × 1.5	46.676	46.376	46.50	46.60
MF 50 × 3	47.252	46.752	47.00	47.13
MF 50 × 2	48.210	47.835	48.00	48.12

Size	Minor Diameter		Drill Size	Recommended Hole Size
	Max.	Min.		
MF 50 × 1.5	48.676	48.376	48.50	48.60
MF 52 × 4	48.270	47.670	48.00	48.10
MF 52 × 3	49.252	48.752	49.00	49.10
MF 52 × 2	50.210	49.835	50.00	50.10
MF 52 × 1.5	50.676	50.376	50.50	50.60
MF 55 × 4	51.270	50.670	51.00	51.10
MF 55 × 3	52.252	51.752	52.00	52.10
MF 55 × 2	53.210	52.835	53.00	53.10
MF 55 × 1.5	53.676	53.376	53.50	53.60
MF 56 × 4	52.270	51.670	52.00	52.10
MF 56 × 3	53.252	52.752	53.00	53.10
MF 56 × 2	54.210	53.835	54.00	54.10
MF 56 × 1.5	54.676	54.376	54.50	54.60
MF 58 × 4	54.270	53.670	54.00	54.10
MF 58 × 3	55.252	54.752	55.00	55.10
MF 58 × 2	56.210	55.835	56.00	56.10
MF 58 × 1.5	56.676	56.376	56.50	56.60
MF 60 × 4	56.270	55.670	56.00	56.10
MF 60 × 3	57.252	56.752	57.00	57.10
MF 60 × 2	58.210	57.835	58.00	58.10
MF 60 × 1.5	58.676	58.376	58.50	58.60
MF 62 × 4	58.270	57.670	58.00	58.10
MF 62 × 3	59.252	58.752	59.00	59.10
MF 62 × 2	60.210	59.835	60.00	60.10
MF 62 × 1.5	60.676	60.376	60.50	60.60
MF 64 × 4	60.270	59.670	60.00	60.10
MF 64 × 3	61.252	60.752	61.00	61.10
MF 64 × 2	62.210	61.835	62.00	62.10
MF 64 × 1.5	62.676	62.376	62.50	62.60
MF 65 × 4	61.270	60.670	61.00	61.10
MF 65 × 3	62.252	61.752	62.00	62.10
MF 65 × 2	63.210	62.835	63.00	63.10
MF 65 × 1.5	63.676	63.376	63.50	63.60
MF 68 × 4	64.270	63.670	64.00	64.10
MF 68 × 3	65.252	64.752	65.00	65.10
MF 68 × 2	66.210	65.835	66.00	66.10
MF 68 × 1.5	66.676	66.376	66.50	66.60
MF 70 × 4	66.270	65.670	66.00	66.10
MF 70 × 3	67.252	66.752	67.00	67.10
MF 70 × 2	68.210	67.835	68.00	68.10
MF 70 × 1.5	68.676	68.376	68.00	68.60
MF 72 × 4	68.270	67.670	68.00	68.10
MF 72 × 3	69.252	68.752	69.00	69.10
MF 72 × 2	70.210	69.835	70.00	70.10
MF 72 × 1.5	70.676	70.376	70.50	70.60
MF 75 × 4	71.270	70.670	71.00	71.10
MF 75 × 3	72.252	71.752	72.00	72.10
MF 75 × 2	73.210	72.835	73.00	73.10
MF 75 × 1.5	73.676	73.376	73.50	73.60
MF 76 × 4	72.270	71.670	72.00	72.10
MF 76 × 3	73.252	72.752	73.00	73.10

Intro

SP

SL

PO

ST

ROLL

CARBIDE

LONG

HAND TAPS

EG (STI)

SPECIAL THREADS, GAUGES

THREAD MILLS

DIES

CENTER DRILLS

Technical info

24. Drill size and recommended hole size for cutting taps

Intro

SP

Metric Fine Threads (MF)

Unit: mm

Size	Minor Diameter		Drill Size	Recommended Hole Size
	Max.	Min.		
MF 76 × 2	74.210	73.835	74.00	74.10
MF 76 × 1.5	74.676	74.376	74.50	74.60
MF 78 × 2	76.210	75.835	76.00	76.10
MF 80 × 4	76.270	75.670	76.00	76.10
MF 80 × 3	77.252	76.752	77.00	77.10
MF 80 × 2	78.210	77.835	78.00	78.10
MF 80 × 1.5	78.676	78.376	78.50	78.60
MF 82 × 2	80.210	79.835	80.00	80.10
MF 85 × 4	81.270	80.670	81.00	81.10
MF 85 × 3	82.252	81.752	82.00	82.10
MF 85 × 2	83.210	82.835	83.00	83.10
MF 90 × 4	86.270	85.670	86.00	86.10
MF 90 × 3	87.252	86.752	87.00	87.10
MF 90 × 2	88.210	87.835	88.00	88.10
MF 95 × 4	91.270	90.670	91.00	91.10
MF 95 × 3	92.252	91.752	92.00	92.10
MF 95 × 2	93.210	92.835	93.00	93.10
MF 100 × 4	96.270	95.670	96.00	96.10
MF 100 × 3	97.252	96.752	97.00	97.10
MF 100 × 2	98.210	97.835	98.00	98.10

SL

PO

ST

ROLL

CARBIDE

LONG

HAND TAPS

EG (STI)

SPECIAL THREADS, GAUGES

THREAD MILLS

DIES

CENTER DRILLS

Technical info

Miniature threads (S)

Unit: mm

Size	Recommended Hole Size
S 0.4 X 0.1	0.32
S 0.5 X 0.125	0.41
S 0.6 X 0.15	0.49
S 0.7 X 0.175	0.57
S 0.8 X 0.2	0.65
S 0.9 X 0.225	0.73

Unified Coarse Threads (UNC)

Unit: mm

Size	Minor Diameter		Drill Size	Recommended Hole Size
	Max.	Min.		
No. 1 - 64 UNC	1.582	1.425	1.55	1.54
No. 2 - 56 UNC	1.871	1.695	1.80	1.83
No. 3 - 48 UNC	2.146	1.941	2.10	2.09
No. 4 - 40 UNC	2.385	2.157	2.30	2.33
No. 5 - 40 UNC	2.697	2.487	2.60	2.64
No. 6 - 32 UNC	2.895	2.642	2.80	2.83
No. 8 - 32 UNC	3.530	3.302	3.40	3.47
No. 10 - 24 UNC	3.962	3.683	3.90	3.89
No. 12 - 24 UNC	4.597	4.344	4.50	4.53
1/4 - 20 UNC	5.257	4.979	5.10	5.19
5/16 - 18 UNC	6.731	6.401	6.60	6.65
3/8 - 16 UNC	8.153	7.798	8.00	8.07
7/16 - 14 UNC	9.550	9.144	9.40	9.45
1/2 - 13 UNC	11.023	10.592	10.90	10.91
9/16 - 12 UNC	12.446	11.989	12.20	12.33
5/8 - 11 UNC	13.868	13.386	13.60	13.75
3/4 - 10 UNC	16.840	16.307	16.60	16.7
7/8 - 9 UNC	19.761	19.177	19.60	19.61
1 - 8 UNC	22.606	21.971	22.30	22.45
1 1/8 - 7 UNC	25.349	24.638	25.00	25.17
1 1/4 - 7 UNC	28.524	27.813	28.20	28.35
1 3/8 - 6 UNC	31.115	30.353	30.80	30.92
1 1/2 - 6 UNC	34.290	33.528	34.00	34.10
1 3/4 - 5 UNC	39.827	38.964	39.50	39.61
2 - 4.5 UNC	45.593	44.679	45.20	45.37

Unified Fine Threads (UNF)

Unit: mm

Size	Minor Diameter		Drill Size	Recommended Hole Size
	Max.	Min.		
No. 0 - 80 UNF	1.305	1.182	1.25	1.27
No. 1 - 72 UNF	1.612	1.474	1.55	1.58
No. 2 - 64 UNF	1.912	1.756	1.85	1.87
No. 3 - 56 UNF	2.197	2.025	2.10	2.15
No. 4 - 48 UNF	2.458	2.271	2.40	2.41
No. 5 - 44 UNF	2.740	2.551	2.70	2.69
No. 6 - 40 UNF	3.022	2.820	2.90	2.97
No. 8 - 36 UNF	3.606	3.404	3.50	3.55
No. 10 - 32 UNF	4.165	3.963	4.10	4.12
No. 12 - 28 UNF	4.724	4.496	4.60	4.67
1/4 - 28 UNF	5.588	5.360	5.50	5.53
5/16 - 24 UNF	7.035	6.782	6.90	6.97
3/8 - 24 UNF	8.636	8.382	8.50	8.57
7/16 - 20 UNF	10.033	9.729	9.90	9.96
1/2 - 20 UNF	11.607	11.329	11.50	11.54
9/16 - 18 UNF	13.081	12.751	12.90	13.00
5/8 - 18 UNF	14.681	14.351	14.50	14.6
3/4 - 16 UNF	17.678	17.323	17.50	17.59
7/8 - 14 UNF	20.675	20.270	20.50	20.57
1 - 12 UNF	23.571	23.114	23.30	23.46
1 1/8 - 12 UNF	26.746	26.289	26.50	26.63
1 1/4 - 12 UNF	29.921	29.464	29.60	29.81
1 3/8 - 12 UNF	33.096	32.639	32.80	32.98
1 1/2 - 12 UNF	36.271	35.814	36.00	36.16

Unified Threads (8UN)

Unit: mm

Size	Minor Diameter		Drill Size	Recommended Hole Size
	Max.	Min.		
1"1/8 - 8 UN	25.781	25.146	25.50	25.62
1"1/4 - 8 UN	28.956	28.321	28.50	28.80
1"3/8 - 8 UN	32.131	31.496	31.80	31.97
1"1/2 - 8 UN	35.306	34.671	35.00	35.15
1"5/8 - 8 UN	38.481	37.846	38.10	38.32
1"3/4 - 8 UN	41.656	41.021	41.30	41.50
2 - 8 UN	48.006	47.371	47.80	47.85

Unified Threads (12UN)

Unit: mm

Size	Minor Diameter		Drill Size	Recommended Hole Size
	Max.	Min.		
1"5/8 - 12 UN	39.446	38.989	39.10	39.33
1"3/4 - 12 UN	42.621	42.164	42.30	42.51
2 - 12 UN	48.971	48.514	48.60	48.86

Unified Extra Fine Threads (UNEF)

Unit: mm

No.	Size	Minor Diameter		Drill Size	Recommended Hole Size
		Max.	Min.		
12	- 32 UNEF	4.826	4.623	4.70	4.78
	1/4 - 32 UNEF	5.689	5.487	5.60	5.64
	5/16 - 32 UNEF	7.264	7.087	7.10	7.22
	3/8 - 32 UNEF	8.864	8.662	8.70	8.81
	7/16 - 28 UNEF	10.337	10.135	10.20	10.29
	1/2 - 28 UNEF	11.938	11.710	11.80	11.88
	9/16 - 24 UNEF	13.385	13.132	13.20	13.32
	5/8 - 24 UNEF	14.986	14.732	14.80	14.92
	3/4 - 20 UNEF	17.957	17.679	17.80	17.89
	7/8 - 20 UNEF	21.132	20.854	21.00	21.06
	1 - 20 UNEF	24.307	24.029	24.10	24.24
	1"1/8 - 18 UNEF	27.381	27.051	27.20	27.3
	1"1/4 - 18 UNEF	30.556	30.226	30.30	30.47
	1"3/8 - 18 UNEF	33.731	33.401	33.50	33.65
	1"1/2 - 18 UNEF	36.906	36.576	36.70	36.82
	1"5/8 - 18 UNEF	40.081	39.751	39.80	40.00

Cylindrical Pipe Threads - G(BSP)

Unit: mm

Size	Minor Diameter		Drill Size	Recommended Hole Size
	Max.	Min.		
G 1/16 - 28	6.843	6.561	6.75	6.77
G 1/8 - 28	8.848	8.566	8.75	8.78
G 1/4 - 19	11.890	11.445	11.75	11.78
G 3/8 - 19	15.395	14.950	15.25	15.28
G 1/2 - 14	19.172	18.631	19.00	19.04
G 5/8 - 14	21.128	20.587	21.00	21.00
G 3/4 - 14	24.658	24.117	24.50	24.52
G 7/8 - 14	28.418	27.877	28.25	28.28
G 1 - 11	30.931	30.291	30.75	30.77
G 1 1/8 - 11	35.579	34.939	35.30	35.42
G 1 1/4 - 11	39.592	38.952	39.30	39.43
G 1 1/2 - 11	45.485	44.845	45.25	45.33
G 1 3/4 - 11	51.428	50.788	51.25	51.27
G 2 - 11	57.296	56.656	57.00	57.14
G 2 1/2 - 11	72.866	72.226	72.50	72.70
G 3 - 11	85.566	84.926	85.25	85.40
G 3 1/2 - 11	98.012	97.372	97.75	97.90
G 4 - 11	110.712	110.072	110.50	110.60

Parallel Internal Pipe Threads - Rp(BSP) - PS

Unit: mm

Size	Minor Diameter		Drill Size	Recommended Hole Size
	Max.	Min.		
Rp 1/16 - 28	6.632	6.490	6.50	6.55
Rp 1/8 - 28	8.637	8.495	8.50	8.55
Rp 1/4 - 19	11.549	11.341	11.40	11.50
Rp 3/8 - 19	15.054	14.846	14.80	14.90
Rp 1/2 - 14	18.773	18.489	18.50	18.55
Rp 5/8 - 14	20.729	20.445	20.50	20.55
Rp 3/4 - 14	24.259	23.975	24.00	24.10
Rp 7/8 - 14	28.019	27.735	27.75	27.80
Rp 1 - 11	30.472	30.110	30.20	30.25
Rp 1 1/8 - 11	35.120	34.758	34.75	34.80
Rp 1 1/4 - 11	39.133	38.771	38.75	38.80
Rp 1 1/2 - 11	45.026	44.664	44.60	44.70
Rp 1 3/4 - 11	50.969	50.607	50.60	50.70
Rp 2 - 11	56.837	56.475	56.50	56.60
Rp 2 1/4 - 11	62.933	62.571	62.50	62.60
Rp 2 1/2 - 11	72.442	72.010	72.00	72.10
Rp 3 - 11	85.142	84.710	84.75	84.80
Rp 3 1/2 - 11	97.588	97.156	97.20	97.30
Rp 4 - 11	110.288	109.856	109.90	110.00

Hand Taps

Thread Mills

Dies

Center Drills

Technical info

24. Drill size and recommended hole size for cutting taps

Intro

SP

American Pipe Threads (NPSC)

Unit: mm

Size	Minor Diameter		Drill Size	Recommended Hole Size
	Max.	Min.		
NPSC 1/16 - 27	6.604	6.300	6.50	6.53
NPSC 1/8 - 27	8.940	8.636	8.80	8.86
NPSC 1/4 - 18	11.633	11.227	11.50	11.53
NPSC 3/8 - 18	15.087	14.656	14.90	14.98
NPSC 1/2 - 14	18.643	18.161	18.50	18.52
NPSC 3/4 - 14	24.003	23.495	23.75	23.88
NPSC 1 - 11.5	30.073	29.490	29.80	29.93
NPSC 1 1/4 - 11.5	38.836	38.253	38.50	38.69
NPSC 1 1/2 - 11.5	44.907	44.323	44.75	44.76
NPSC 2 - 11.5	56.946	56.363	56.75	56.80

SL

PO

ST

American Pipe Threads (NPSM)

Unit: mm

Size	Minor Diameter		Drill Size	Recommended Hole Size
	Max.	Min.		
NPSM 1/16 - 27	6.898	6.747	6.80	6.86
NPSM 1/8 - 27	9.246	9.094	9.20	9.21
NPSM 1/4 - 18	12.217	11.888	12.10	12.13
NPSM 3/8 - 18	15.554	15.317	15.50	15.49
NPSM 1/2 - 14	19.278	18.974	19.20	19.20
NPSM 3/4 - 14	24.638	24.334	24.50	24.60
NPSM 1 - 11.5	30.759	30.506	30.60	30.70
NPSM 1 1/4 - 11.5	39.497	39.269	39.40	39.40
NPSM 1 1/2 - 11.5	45.567	45.339	45.50	45.50
NPSM 2 - 11.5	57.607	57.379	57.50	57.60

ROLL

Dryseal American Pipe Threads (NPSF)

Unit: mm

Size	Minor Diameter		Drill Size	Recommended Hole Size
	Max.	Min.		
NPSF 1/16 - 27	6.482	6.305	6.40	6.44
NPSF 1/8 - 27	8.740	8.652	8.70	8.72
NPSF 1/4 - 18	11.363	11.232	11.30	11.33
NPSF 3/8 - 18	14.803	14.672	14.75	14.77
NPSF 1/2 - 14	18.288	18.118	18.25	18.20
NPSF 3/4 - 14	23.634	23.465	23.50	23.50
NPSF 1 - 11.5	29.669	29.464	29.50	29.60
NPSF 1 1/4 - 11.5	38.514	38.220	38.30	38.40
NPSF 1 1/2 - 11.5	44.584	44.290	44.50	44.50
NPSF 2 - 11.5	56.621	56.328	56.50	56.50

CARBIDE

LONG

HAND TAPS

EG (STI)

SPECIAL THREADS, GAUGES

THREAD MILLS

DIES

CENTER DRILLS

Technical info

Taper Internal Pipe Threads - Rc(BSPT)-PT (refer to JIS B 0203 or ISO 7-1)

Unit: mm

Size	Thread Standards				Minor Diameter			Recommended Bored Hole Sizes (reference)		Reference		
	Basic Diameter	Basic Diameter	Effective Thread Length (Minimum)		Pipe End (Workpiece Face) (Basic Diameter)	When Threads have non-Full Threads	When Threads do not have the non-Full Threads	Maximum Size of Straight Bored Hole		Tap		
			When Threads have non-Full Threads ℓ	When Threads do not have the non-Full Threads t		Position away from Pipe End by ℓ	Position away from Pipe End by t	When Threads have non-Full Threads	When Threads do not have the non-Full Threads	Long Thread Type	Short Thread Type	Rc
	Tolerance in radial direction	Tolerance in axial direction c	Basic Size	Basic Size	Basic Size							
①	②	③	④	⑤	⑥	⑦	⑧	⑨	⑩	⑪	⑫	⑬
PT 1/16 - 28	±0.071	±1.13	6.2	4.4	6.561	6.174	6.286	6.1	6.2	13.0	10.5	10.1
PT 1/8 - 28	±0.071	±1.13	6.2	4.4	8.566	8.179	8.291	8.1	8.2	13.0	10.5	10.1
PT 1/4 - 19	±0.104	±1.67	9.4	6.7	11.445	10.858	11.026	10.7	10.9	21.0	12.5	15.0
PT 3/8 - 19	±0.104	±1.67	9.7	7.0	14.950	14.344	14.513	14.2	14.4	21.0	14.0	15.4
PT 1/2 - 14	±0.142	±2.27	12.7	9.1	18.631	17.837	18.062	17.6	17.9	25.0	17.0	20.5
PT 5/8 - 14	±0.142	±2.27	(13.4)	(9.65)	20.587	19.750	19.984	19.6	19.8	25.0	-	-
PT 3/4 - 14	±0.142	±2.27	14.1	10.2	24.117	23.236	23.480	23.0	23.3	25.0	19.0	21.8
PT 7/8 - 14	±0.142	±2.27	(15.2)	(10.9)	27.877	26.930	27.196	26.7	27.0	28.0	-	-
PT 1 - 11	±0.181	±2.89	16.2	11.6	30.291	29.279	29.566	29.0	29.3	32.0	22.0	26.0
PT 1 1/8 - 11	±0.181	±2.89	(17.4)	(12.5)	34.939	33.855	34.158	33.6	33.9	32.0	-	-
PT 1 1/4 - 11	±0.181	±2.89	18.5	13.4	38.952	37.796	38.115	37.6	37.9	32.0	24.5	28.3
PT 1 1/2 - 11	±0.181	±2.89	18.5	13.4	44.845	43.689	44.008	43.5	43.8	32.0	25.5	28.3
PT 1 3/4 - 11	±0.181	±2.89	(18.5)	(13.4)	50.788	49.632	49.951	49.4	49.7	32.0	-	-
PT 2 - 11	±0.181	±2.89	22.8	16.9	56.656	55.231	55.600	55.0	55.4	35.0	27.5	32.7
PT 2 1/4 - 11	±0.216	±3.46	(26.7)	(18.6)	65.710	64.041	64.548	63.8	64.3	50.0	-	-
PT 2 1/2 - 11	±0.216	±3.46	26.7	18.6	72.226	70.557	71.064	70.3	70.8	50.0	32.0	37.1
PT 3 - 11	±0.216	±3.46	29.8	21.1	84.926	83.064	83.607	82.8	83.3	52.0	36.0	40.2
PT 3 1/2 - 11	±0.216	±3.46	31.4	22.4	97.372	95.410	95.972	95.1	95.7	52.0	-	46.2
PT 4 - 11	±0.216	±3.46	35.8	25.9	110.072	107.835	108.453	107.6	108.2	55.0	-	46.2

Note: Length toward End of Smaller Diameter from Basic Diameter Position

REMARKS DURING TAPPING

1. PT internal threads have R design on their crests. The tap should cut threads with their thread rot.
2. On thread drawing non-full threads. If you are going to cut effective thread length ℓ , use the tap of long type.

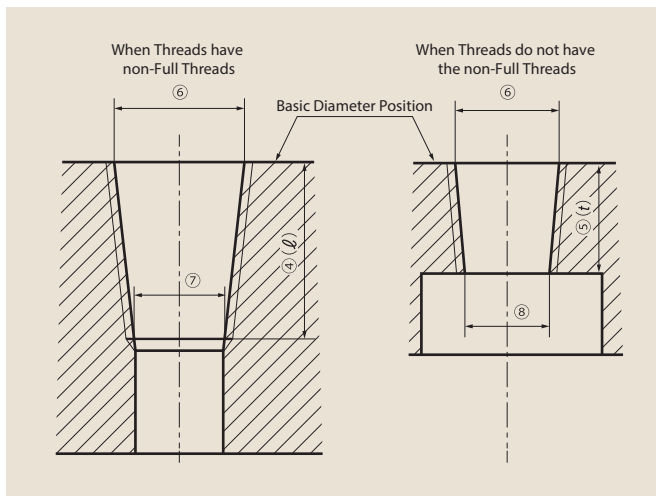

- Remarks 1. Opening of Internal Thread (Face of workpiece) is Basic Diameter Position.
- Remarks 2. Effective Thread Length has 2 types: with non-Full Thread Type and without non-Full Thread Type.
- Remarks 3. Concerning bored hole shape, considering load on taps, taper bored hole is recommended.
- Remarks 4. Use the machines that has synchronized feed system in the case of taper bored hole.
- Remarks 5. When applying taper bored hole, by referring to values shown in columns ②⑤⑧, prepare the taper hole by using pipe reamer (1/16 taper). By referring to values shown in columns ⑨ and ⑩, select the drill diameter before reaming by taking reamer's margin into account.
- Remarks 6. When preparing straight bored hole, by referring to values shown in columns ⑨ and ⑩, select drill diameter.

24. Drill size and recommended hole size for cutting taps

Intro

American Taper Pipe Threads (NPT) (Refer to ANSI/ASME B1.20.1-1983)

Unit: mm

Size	L1	L3	L1+L3	Minor Diameter						Bored Hole Size (reference)	reference Tap
				Pipe End (Basic Diameter Position)			Position away from Pipe End by (L1+L3)				
				Maximum Value	Minimum Value	Tolerance	Maximum Value	Minimum Value	Tolerance	⑪	⑫
①	②	③	④	⑤	⑥	⑦	⑧	⑨	⑩	⑪	⑫
NPT 1/16 - 27	4.064	2.822	6.886	6.510	6.388	0.122	6.080	5.958	0.122	6.05	12.00
NPT 1/8 - 27	4.102	2.822	6.924	8.857	8.736	0.121	8.425	8.303	0.122	8.39	12.05
NPT 1/4 - 18	5.786	4.234	10.020	11.514	11.357	0.157	10.888	10.730	0.158	10.85	17.45
NPT 3/8 - 18	6.096	4.234	10.330	14.953	14.796	0.157	14.308	14.150	0.158	14.27	17.65
NPT 1/2 - 14	8.128	5.443	13.571	18.485	18.323	0.162	17.637	17.475	0.162	17.60	22.85
NPT 3/4 - 14	8.611	5.443	14.054	23.831	23.668	0.163	22.952	22.790	0.162	22.91	22.95
NPT 1 - 11.5	10.160	6.627	16.787	29.868	29.696	0.172	28.819	28.647	0.172	28.78	27.40
NPT 1 1/4 - 11.5	10.668	6.627	17.295	38.625	38.452	0.173	37.544	37.372	0.172	37.50	28.10
NPT 1 1/2 - 11.5	10.668	6.627	17.295	44.695	44.522	0.173	43.614	43.441	0.173	43.57	28.40
NPT 2 - 11.5	11.074	6.627	17.701	56.732	56.560	0.172	55.626	55.454	0.172	55.58	28.00
NPT 2 1/2 - 8	17.323	6.350	23.673	67.806	67.618	0.188	66.326	66.138	0.188	66.28	40.80
NPT 3 - 8	19.456	6.350	25.806	83.715	83.527	0.188	82.102	81.914	0.188	82.05	42.95

ROLL

CARBIDE

LONG

HAND TAPS

EG (STI)

SPECIAL THREADS, GAUGES

THREAD MILLS

DIES

CENTER DRILLS

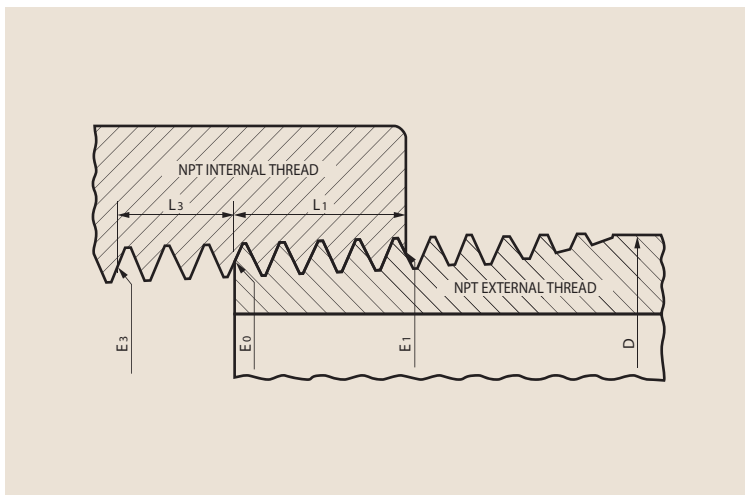

- Remarks 1. Pipe End is Basic Diameter Position (E1).
- Remarks 2. Effective Thread Length is the length away from Pipe End by (L1+L3).
- Remarks 3. Concerning bored hole shape, considering load on taps, taper bored hole is recommended.
- Remarks 4. When applying taper bored hole. by referring to values in shown columns ⑤, ⑥ and ⑧, ⑨, prepare the taper hole by using pipe reamer (1/16 taper). By referring to values shown in column ⑪, select the drill diameter before reaming by taking reamer's margin into account.
- Remarks 5. When preparing straight bored hole, by referring to values shown in column ⑩, select drill diameter.

Technical info

American Taper Pipe Threads (NPTF) (Refer to ANSI/ASME B1.20.1-1983)

Unit: mm

Size	L1	L3 (3P)	L1+L3+1P	Minor Diameter						Bored Hole Size (reference)	reference
				Pipe End (Basic Diameter Position)			Position away from Pipe End by (L1+L3+1P)				Maximum Size of Straight Bored Hole
				Maximum Value	Minimum Value	Tolerance	Maximum Value	Minimum Value	Tolerance	Basic Diameter Position ℓg	
①	②	③	④	⑤	⑥	⑦	⑧	⑨	⑩	⑪	⑫
NPTF 1/16 - 27	4.064	2.822	7.827	6.505	6.414	0.091	6.015	5.923	0.092	5.99	12.00
NPTF 1/8 - 27	4.102	2.822	7.865	8.852	8.761	0.091	8.362	8.270	0.092	8.34	12.05
NPTF 1/4 - 18	5.786	4.234	11.431	11.484	11.397	0.087	10.770	10.684	0.086	10.75	17.45
NPTF 3/8 - 18	6.096	4.234	11.741	14.923	14.836	0.087	14.189	14.103	0.086	14.17	17.65
NPTF 1/2 - 14	8.128	5.443	15.386	18.419	18.333	0.086	17.459	17.373	0.086	17.44	22.85
NPTF 3/4 - 14	8.611	5.443	15.868	23.764	23.678	0.086	22.773	22.687	0.086	22.75	22.95
NPTF 1 - 1 1.5	10.160	6.627	18.996	29.812	29.726	0.086	28.625	28.538	0.087	28.60	27.40
NPTF 1 1/4 - 1 1.5	10.668	6.627	19.504	38.569	38.483	0.086	37.350	37.263	0.087	37.33	28.10
NPTF 1 1/2 - 1 1.5	10.668	6.627	19.504	44.639	44.552	0.087	43.420	43.334	0.086	43.40	28.40
NPTF 2 - 1 1.5	11.074	6.627	19.910	56.677	56.590	0.087	55.432	55.345	0.087	55.41	28.00

SP

SL

PO

ST

ROLL

CARBIDE

LONG

HAND TAPS

EG (STI)

SPECIAL THREADS, GAUGES

THREAD MILLS

DIES

CENTER DRILLS

Technical info

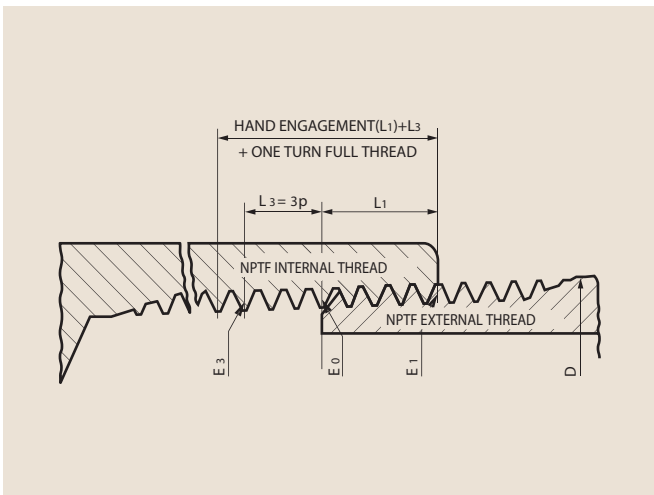

- Remarks 1. Pipe End is Basic Diameter Position (E1).
- Remarks 2. Effective Thread Length is the length away from Pipe End by (L1+L3+1P).
- Remarks 3. Concerning bored hole shape, considering load on taps, taper bored hole is recommended.
- Remarks 4. When applying taper bored hole, by referring to values shown in columns ⑤, ⑥ and ⑧, ⑨, prepare the taper hole by using pipe reamer (1/16 taper). By referring to values in shown column ⑪, select the drill diameter before reaming by taking reamer's margin into account.
- Remarks 5. When preparing straight bored hole, by referring to values shown in column ⑪, select drill diameter.

24. Drill size and recommended hole size for cutting taps

Intro

Whitworth Threads (BSW)

Unit: mm

Size	Minor Diameter		Drill Size	Recommended Hole Size
	Max.	Min.		
BSW 1/16 - 60	1.23	1.107	1.15	1.20
BSW 3/32 - 48	1.914	1.785	1.85	1.88
BSW 1/8 - 40	2.591	2.456	2.55	2.56
BSW 5/32 - 32	3.214	3.071	3.15	3.20
BSW 3/16 - 24	3.745	3.563	3.70	3.70
BSW 7/32 - 24	4.54	4.358	4.50	4.49
BSW 1/4 - 20	5.204	4.914	5.10	5.13
BSW 5/16 - 18	6.67	6.34	6.50	6.59
BSW 3/8 - 16	8.113	7.733	8.00	8.02
BSW 7/16 - 14	9.508	9.048	9.30	9.39
BSW 1/2 - 12	10.83	10.31	10.60	10.70
BSW 9/16 - 12	12.418	11.898	12.25	12.29
BSW 5/8 - 11	13.817	13.257	13.50	13.68
BSW 3/4 - 10	16.778	16.178	16.50	16.63
BSW 7/8 - 9	19.691	19.031	19.50	19.53
BSW 1 - 8	22.514	21.814	22.20	22.34
BSW 1 1/8 - 7	25.229	24.469	24.75	25.04
BSW 1 1/4 - 7	28.404	27.644	28.00	28.21
BSW 1 3/8 - 6	30.923	30.123	30.50	30.72
BSW 1 1/2 - 6	34.098	33.298	33.75	33.90
BSW 1 5/8 - 5	36.409	35.529	36.00	36.19
BSW 1 3/4 - 5	39.584	38.704	39.20	39.36
BSW 1 7/8 - 4 1/2	42.227	41.237	42.00	41.98
BSW 2 - 4.5	45.402	44.412	45.00	45.15
BSW 2 1/4 - 4	51.068	49.958	50.50	50.79
BSW 2 1/2 - 4	57.418	56.308	57.00	57.14
BSW 2 3/4 - 3 1/2	62.816	61.636	62.50	62.52
BSW 3 - 3 1/2	69.166	67.986	68.50	68.87
BSW 3 1/4 - 3 1/4	74.902	73.702	74.50	74.60
BSW 3 1/2 - 3 1/4	81.252	80.052	81.00	81.10
BSW 3 3/4 - 3	86.908	85.668	86.50	86.60
BSW 4 - 3	93.258	92.018	92.80	92.95

Helical Coil Wire Thread Inserts Metric Coarse (EG STI M)

Unit: mm

Size	Minor Diameter		Drill Size	Recommended Hole Size
	Max.	Min.		
EG(STI) M 2 × 0.4	2.16	2.10	2.13	2.15
EG(STI) M 2.5 × 0.45	2.68	2.60	2.60	2.66
EG(STI) M 2.6 × 0.45	2.78	2.70	2.70	2.76
EG(STI) M 3 × 0.5	3.20	3.12	3.15	3.18
EG(STI) M 4 × 0.7	4.30	4.17	4.20	4.27
EG(STI) M 5 × 0.8	5.33	5.16	5.20	5.29
EG(STI) M 6 × 1	6.42	6.25	6.30	6.38
EG(STI) M 8 × 1.25	8.52	8.31	8.40	8.47
EG(STI) M 10 × 1.5	10.62	10.37	10.50	10.56
EG(STI) M 12 × 1.75	12.73	12.43	12.60	12.66
EG(STI) M 14 × 2	14.83	14.49	14.70	14.75
EG(STI) M 16 × 2	16.83	16.49	16.70	16.75
EG(STI) M 18 × 2.5	19.04	18.58	18.90	18.93
EG(STI) M 20 × 2.5	21.04	20.58	20.90	20.93
EG(STI) M 22 × 2.5	23.04	22.58	22.90	22.93
EG(STI) M 24 × 3	25.25	24.70	25.10	25.11

SP

SL

PO

ST

ROLL

CARBIDE

LONG

HAND TAPS

EG (STI)

Helical Coil Wire Thread Inserts Metric Fine (EG STI MF)

Unit: mm

Size	Minor Diameter		Drill Size	Recommended Hole Size
	Max.	Min.		
EG(STI) MF 10 × 1.25	10.52	10.31	10.40	10.47
EG(STI) MF 10 × 1	10.42	10.25	10.30	10.38
EG(STI) MF 12 × 1.5	12.62	12.37	12.50	12.56
EG(STI) MF 12 × 1.25	12.52	12.31	12.40	12.47
EG(STI) MF 14 × 1.5	14.62	14.37	14.50	14.56
EG(STI) MF 14 × 1.25	14.52	14.31	14.40	14.47
EG(STI) MF 16 × 1.5	16.62	16.37	16.50	16.56
EG(STI) MF 18 × 1.5	18.62	18.37	18.50	18.56
EG(STI) MF 20 × 1.5	20.62	20.37	20.50	20.56
EG(STI) MF 22 × 1.5	22.62	22.37	22.50	22.56
EG(STI) MF 24 × 1.5	24.62	24.37	24.50	24.56

SPECIAL THREADS, GAUGES

Helical Coil Wire Thread Inserts Unified Coarse (EG STI UNC)

Unit: mm

Size	Minor Diameter		Drill Size	Recommended Hole Size
	Max.	Min.		
EG(STI) No. 2 - 56 UNC	2.440	2.284	2.35	2.4
EG(STI) No. 4 - 40 UNC	3.180	2.985	3.10	3.13
EG(STI) No. 5 - 40 UNC	3.487	3.315	3.40	3.44
EG(STI) No. 6 - 32 UNC	3.878	3.678	3.80	3.83
EG(STI) No. 8 - 32 UNC	4.523	4.339	4.40	4.48
EG(STI) No. 10 - 24 UNC	5.283	5.055	5.20	5.23
EG(STI) No. 12 - 24 UNC	5.943	5.715	5.80	5.89
EG(STI) 1/4 - 20 UNC	6.868	6.625	6.80	6.81
EG(STI) 5/16 - 18 UNC	8.488	8.243	8.40	8.43
EG(STI) 3/8 - 16 UNC	10.126	9.868	10.00	10.06
EG(STI) 7/16 - 14 UNC	11.783	11.507	11.70	11.71
EG(STI) 1/2 - 13 UNC	13.393	13.122	13.20	13.33
EG(STI) 5/8 - 11 UNC	16.672	16.376	16.50	16.60

Helical Coil Wire Thread Inserts Unified Fine (EG STI UNF)

Unit: mm

Size	Minor Diameter		Drill Size	Recommended Hole Size
	Max.	Min.		
EG(STI) No. 4 - 48 UNF	3.121	2.962	3.00	3.08
EG(STI) No. 6 - 40 UNF	3.817	3.645	3.70	3.77
EG(STI) No. 8 - 36 UNF	4.498	4.321	4.40	4.45
EG(STI) No. 10 - 32 UNF	5.184	4.999	5.10	5.14
EG(STI) 1/4 - 28 UNF	6.720	6.546	6.60	6.68
EG(STI) 5/16 - 24 UNF	8.351	8.167	8.30	8.31
EG(STI) 3/8 - 24 UNF	9.931	9.754	9.80	9.89
EG(STI) 7/16 - 20 UNF	11.584	11.387	11.50	11.53
EG(STI) 1/2 - 20 UNF	13.172	12.975	13.10	13.12
EG(STI) 5/8 - 18 UNF	16.385	16.180	16.30	16.33
EG(STI) 3/4 - 16 UNF	19.608	19.393	19.50	19.55

THREAD MILLS

DIES

CENTER DRILLS

Technical info

24. Drill size and recommended hole size for cutting taps

Intro

Aerospace Metric Coarse Threads (MJ)

Unit: mm

Size	Minor Diameter		Drill Size	Recommended Hole Size
	Max.	Min.		
MJ 3 x 0.5	2.653	2.513	2.60	2.62
MJ 4 x 0.7	3.498	3.318	3.10	3.45
MJ 5 x 0.8	4.421	4.221	4.30	4.37
MJ 6 x 1	5.216	5.026	5.10	5.17
MJ 8 x 1.25	6.994	6.782	6.90	6.94
MJ 10 x 1.5	8.775	8.539	8.65	8.72
MJ 12 x 1.75	10.560	10.295	10.43	10.50
MJ 16 x 2	14.351	14.051	14.20	14.30

Aerospace Metric Fine Threads (MFJ)

Unit: mm

Size	Minor Diameter		Drill Size	Recommended Hole Size
	Max.	Min.		
MJ 8 x 1	7.216	7.026	7.10	7.17

SP

SL

PO

ST

Aerospace Unified Coarse Threads (UNJC)

Unit: mm

Size	Minor Diameter		Drill Size	Recommended Hole Size
	Max.	Min.		
No. 2 - 56 UNJC	1.859	1.743	1.81	1.83
No. 3 - 48 UNJC	2.136	1.999	2.10	2.10
No. 4 - 40 UNJC	2.392	2.228	2.30	2.35
No. 5 - 40 UNJC	2.722	2.558	2.60	2.68
No. 6 - 32 UNJC	2.938	2.734	2.84	2.89
No. 8 - 32 UNJC	3.599	3.394	3.50	3.55
No. 10 - 24 UNJC	4.064	3.795	3.93	4.00
No. 12 - 24 UNJC	4.704	4.456	4.60	4.64
1/4 - 20 UNJC	5.387	5.114	5.30	5.32
5/16 - 18 UNJC	6.832	6.564	6.70	6.76
3/8 - 16 UNJC	8.255	7.979	8.10	8.19
7/16 - 14 UNJC	9.639	9.348	9.50	9.57
1/2 - 13 UNJC	11.094	10.798	11.00	11.02
9/16 - 12 UNJC	12.481	12.228	12.40	12.42
5/8 - 11 UNJC	13.903	13.628	13.80	13.83
3/4 - 10 UNJC	16.880	16.577	16.70	16.80
7/8 - 9 UNJC	19.814	19.477	19.70	19.73
1 - 8 UNJC	22.689	22.309	22.50	22.59

Aerospace Unified Fine Threads (UNJF)

Unit: mm

Size	Minor Diameter		Drill Size	Recommended Hole Size
	Max.	Min.		
No. 2 - 64 UNJF	1.902	1.799	1.86	1.88
No. 3 - 56 UNJF	2.189	2.073	2.10	2.16
No. 4 - 48 UNJF	2.466	2.330	2.40	2.43
No. 5 - 44 UNJF	2.763	2.614	2.70	2.73
No. 6 - 40 UNJF	3.053	2.888	3.00	3.01
No. 8 - 36 UNJF	3.662	3.480	3.60	3.62
No. 10 - 32 UNJF	4.254	4.054	4.20	4.20
No. 12 - 28 UNJF	4.815	4.603	4.70	4.76
1/4 - 28 UNJF	5.661	5.467	5.60	5.61
5/16 - 24 UNJF	7.109	6.907	7.00	7.06
3/8 - 24 UNJF	8.679	8.494	8.60	8.63
7/16 - 20 UNJF	10.083	9.876	10.00	10.03
1/2 - 20 UNJF	11.661	11.464	11.60	11.61
9/16 - 18 UNJF	13.121	12.914	13.00	13.07
5/8 - 18 UNJF	14.701	14.501	14.60	14.65
3/4 - 16 UNJF	17.721	17.506	17.60	17.67
7/8 - 14 UNJF	20.706	20.460	20.60	20.64
1 - 12 UNJF	23.594	23.341	23.50	23.53

ROLL

CARBIDE

LONG

HAND TAPS

EG (STI)

SPECIAL THREADS, GAUGES

Steel Conduit Threads (Pg)

Unit: mm

Size	Minor Diameter		Drill Size	Recommended Hole Size
	Max.	Min.		
Pg 7 - 20	11.43	11.28	11.40	11.45
Pg 9 - 18	14.01	13.86	14.00	14.10
Pg 11 - 18	17.41	17.26	17.30	17.35
Pg 13.5 - 18	19.21	19.06	19.10	19.15
Pg 16 - 18	21.31	21.16	21.25	21.30
Pg 21 - 16	27.03	26.78	27.00	27.10
Pg 29 - 16	35.73	35.48	35.60	35.70

THREAD MILLS

DIES

CENTER DRILLS

Technical info

24. Drill size and recommended hole size for cutting taps

Intro

Trapezoidal Threads (Tr)

Unit: mm

SP	Size		Minor Diameter		Drill Size	Recommended Hole Size
			Max.	Min.		
SL	Tr	10 × 2	8.236	8.000	8.20	8.18
	Tr	12 × 2	10.236	10.000	10.20	10.20
	Tr	12 × 3	9.315	9.000	9.20	9.20
PO	Tr	14 × 3	11.315	11.000	11.20	11.20
	Tr	16 × 3	13.315	13.000	13.20	13.20
	Tr	16 × 4	12.375	12.000	12.25	12.30
	Tr	18 × 4	14.375	14.000	14.25	14.30
ST	Tr	20 × 4	16.375	16.000	16.25	16.30
	Tr	22 × 5	17.450	17.000	17.25	17.30
	Tr	24 × 5	19.450	19.000	19.25	19.30
ROLL	Tr	25 × 5	20.450	20.000	20.25	20.30
	Tr	26 × 5	21.450	21.000	21.25	21.30
	Tr	26 × 6	20.500	20.000	20.30	20.40
	Tr	28 × 5	23.450	23.000	23.25	23.30
	Tr	30 × 6	24.500	24.000	24.30	24.40

CARBIDE

LONG

HAND
TAPS

EG (STI)

SPECIAL
THREADS,
GAUGES

THREAD
MILLS

DIES

CENTER
DRILLS

Technical
info

Camera tripod mounting screws

Unit: mm

Size	Minor Diameter		Recommended Hole Size
	Max.	Min.	
1/4 - 20	5.267	4.975	5.19

Camera release mounting taper female thread

Unit: mm

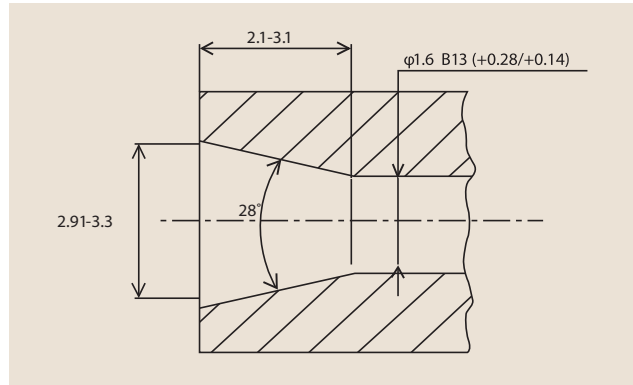

Automotive tire valve screws

Unit: mm

Size	Minor Diameter		Recommended Hole Size
	Max.	Min.	
5 V 1	4.801	4.597	4.75
8 V 1	7.239	7.036	7.19
8 V 2	7.035	6.782	6.97
9 V 1	8.865	8.661	8.81
10 V 1	8.900	8.750	8.86
10 V 2	9.550	9.350	9.50
11 V 1	10.033	9.729	9.96
12 V 1	11.379	11.176	11.33
13 V 1	11.608	11.328	11.54
13 V 2	12.039	11.837	11.99
15 V 1	13.950	13.750	13.90
16 V 1	15.088	14.859	15.03
17 V 1	15.950	15.750	15.90
17 V 2	16.560	16.307	16.50
17 V 3	16.103	15.748	16.01
19 V 1	17.678	17.323	17.59
20 V 1	19.450	19.250	19.40

Bicycle tire valve screws

Unit: mm

Size	Minor Diameter		Recommended Hole Size
	Max.	Min.	
CTV 5 - 36	4.732	4.630	4.71
CTV 5 - 24	4.214	3.954	4.15
CTV 8 - 32	7.192	7.040	7.15
CTV 8 - 30	7.344	7.183	7.30
5 V 2	4.600	4.400	4.55
6 V 1	5.540	5.440	5.52

Thin steel conduit screws (CTC)

Unit: mm

Size	Minor Diameter		Recommended Hole Size
	Max.	Min.	
CTC 19 - 16	18.208	17.808	18.11
CTC 25 - 16	24.508	24.108	24.41
CTC 31 - 16	30.908	30.508	30.81
CTC 39 - 16	37.208	36.808	37.11
CTC 51 - 16	49.908	49.508	49.81
CTC 63 - 16	62.608	62.208	62.51
CTC 75 - 16	75.308	74.908	75.21

Bicycle screws general (BC)

Unit: mm

Size	Minor Diameter		Recommended Hole Size
	Max.	Min.	
BC 5/16 - 26	7.16	7.06	7.13
BC 3/8 - 26	8.75	8.65	8.73
BC 7/16 - 26	10.33	10.23	10.31
BC 1/2 - 20	11.66	11.55	11.63
BC 9/16 - 20	13.25	13.14	13.23
BC 5/8 - 20	14.84	14.73	14.81
BC 11/16 - 24	16.59	16.48	16.57
BC 3/4 - 30	18.40	18.29	18.37
BC 31/32 - 30	23.96	23.85	23.94
BC 1 - 24	24.56	24.44	24.53
BC 1.29 - 24	31.95	31.82	31.92
BC 1.37 - 24	33.98	33.85	33.95
BC 1 7/16 - 24	35.69	35.56	35.66
BC 1.45 - 24	36.01	35.88	35.98
BC 1 9/16 - 24	38.87	38.74	38.84

Thick steel conduit tube screws (CTG)

Unit: mm

Size	Minor Diameter		Recommended Hole Size
	Max.	Min.	
CTG 16 - 14	19.522	19.022	19.40
CTG 22 - 14	25.008	24.508	24.88
CTG 28 - 11	31.361	30.761	31.21
CTG 36 - 11	40.022	39.422	39.87
CTG 42 - 11	45.915	45.315	45.77
CTG 54 - 11	57.826	57.126	57.65
CTG 70 - 11	73.396	72.696	73.22
CTG 82 - 11	86.096	85.396	85.92
CTG 92 - 11	98.542	97.842	98.37
CTG 104 - 11	111.242	110.542	111.07

25. Drill size and recommended hole size for forming taps

Intro

SP

SL

PO

ST

ROLL

CARBIDE

LONG

HAND TAPS

EG (STI)

SPECIAL THREADS, GAUGES

THREAD MILLS

DIES

CENTER DRILLS

Technical info

Metric Coarse Threads (M)

Unit: mm

Size	Class	Minor Diameter			Drill Size	Recommended Hole Size	
		Tol.	Max.	Min.		Max.	Min.
M 1 × 0.25	ISO2X 6H	(0.785)	(0.729)	0.91	0.92	0.89	
	ISO3X 6G	(0.803)	(0.747)	0.92	0.93	0.91	
M 1.2 × 0.25	ISO2X 6H	(0.985)	(0.929)	1.11	1.12	1.09	
	ISO3X 6G	(1.003)	(0.947)	1.12	1.13	1.11	
M 1.4 × 0.3	ISO2X 6H	1.142	1.075	1.27	1.28	1.25	
	ISO3X 6G	1.160	1.093	1.29	1.3	1.27	
M 1.6 × 0.35	ISO2X 6H	1.321	1.221	1.46	1.48	1.43	
	ISO3X 6G	1.340	1.240	1.47	1.49	1.44	
M 1.7 × 0.35	ISO2X 6H	1.421	1.321	1.55	1.57	1.53	
	ISO3X 6G	1.440	1.340	1.57	1.59	1.54	
M 1.8 × 0.35	ISO2X 6H	1.521	1.421	1.65	1.67	1.62	
	ISO3X 6G	1.540	1.440	1.67	1.69	1.64	
M 2 × 0.4	ISO2X 6H	1.679	1.567	1.83	1.86	1.80	
	ISO3X 6G	1.698	1.586	1.85	1.87	1.82	
M 2.2 × 0.45	ISO2X 6H	1.838	1.713	2.01	2.04	1.97	
	ISO3X 6G	1.858	1.733	2.03	2.06	1.99	
M 2.3 × 0.4	ISO2X 6H	1.979	1.867	2.13	2.16	2.10	
	ISO3X 6G	1.998	1.886	2.15	2.17	2.12	
M 2.5 × 0.45	ISO2X 6H	2.138	2.013	2.31	2.34	2.27	
	ISO3X 6G	2.158	2.033	2.34	2.37	2.31	
M 2.6 × 0.45	ISO2X 6H	2.238	2.113	2.41	2.44	2.37	
	ISO3X 6G	2.258	2.133	2.44	2.47	2.41	
M 3 × 0.5	ISO2X 6H	2.599	2.459	2.80	2.83	2.76	
	ISO3X 6G	2.619	2.479	2.82	2.85	2.78	
M 3.5 × 0.6	ISO2X 6H	3.010	2.850	3.25	3.29	3.21	
	ISO3X 6G	3.031	2.871	3.27	3.31	3.23	
M 4 × 0.7	ISO2X 6H	3.422	3.242	3.71	3.75	3.66	
	ISO3X 6G	3.444	3.264	3.73	3.77	3.68	
M 5 × 0.8	ISO2X 6H	4.334	4.134	4.65	4.70	4.60	
	ISO3X 6G	4.358	4.158	4.67	4.72	4.62	
M 6 × 1	ISO2X 6H	5.153	4.917	5.56	5.61	5.50	
	ISO3X 6G	5.179	4.943	5.60	5.65	5.54	
M 8 × 1.25	ISO2X 6H	6.912	6.647	7.45	7.52	7.38	
	ISO3X 6G	6.940	6.675	7.47	7.53	7.40	
M 10 × 1.5	ISO2X 6H	8.676	8.376	9.34	9.41	9.26	
	ISO3X 6G	8.708	8.408	9.37	9.44	9.29	
M 12 × 1.75	ISO2X 6H	10.441	10.106	11.22	11.3	11.13	
	ISO3X 6G	10.475	10.140	11.25	11.33	11.16	
M 14 × 2	ISO2X 6H	12.210	11.835	13.10	13.19	13.00	
	ISO3X 6G	12.248	11.873	13.14	13.23	13.04	
M 16 × 2	ISO2X 6H	14.210	13.835	15.10	15.19	15.00	
	ISO3X 6G	14.248	13.873	15.14	15.23	15.04	

Metric Fine Threads (MF)

Unit: mm

Size	Class	Minor Diameter			Drill Size	Recommended Hole Size	
		Tol.	Max.	Min.		Max.	Min.
MF 6 × 0.75	ISO2X 6H	5.378	5.188	5.67	5.72	5.62	
	ISO3X 6G	5.400	5.210	5.70	5.75	5.65	
MF 6 × 0.5	ISO2X 6H	5.599	5.459	5.78	5.81	5.74	
	ISO3X 6G	5.619	5.479	5.80	5.83	5.76	
MF 8 × 1	ISO2X 6H	7.153	6.917	7.55	7.61	7.49	
	ISO3X 6G	7.179	6.943	7.59	7.65	7.53	
MF 10 × 1.25	ISO2X 6H	8.912	8.647	9.45	9.51	9.38	
	ISO3X 6G	8.940	8.675	9.47	9.53	9.40	
MF 10 × 1	ISO2X 6H	9.153	8.917	9.55	9.61	9.49	
	ISO3X 6G	9.179	8.943	9.59	9.65	9.53	
MF 12 × 1.5	ISO2X 6H	10.676	10.376	11.32	11.39	11.24	
	ISO3X 6G	10.708	10.408	11.35	11.42	11.27	
MF 12 × 1.25	ISO2X 6H	10.912	10.647	11.45	11.51	11.38	
	ISO3X 6G	10.940	10.675	11.46	11.52	11.39	
MF 12 × 1	ISO2X 6H	11.153	10.917	11.56	11.62	11.50	
	ISO3X 6G	11.179	10.943	11.57	11.63	11.51	
MF 14 × 1.5	ISO2X 6H	12.676	12.376	13.32	13.39	13.24	
	ISO3X 6G	12.708	12.408	13.35	13.42	13.27	
MF 14 × 1	ISO2X 6H	13.153	12.917	13.55	13.61	13.49	
	ISO3X 6G	13.179	12.943	13.57	13.62	13.51	
MF 16 × 1.5	ISO2X 6H	14.676	14.376	15.31	15.38	15.23	
	ISO3X 6G	14.708	14.408	15.34	15.41	15.26	
MF 16 × 1	ISO2X 6H	15.153	14.917	15.55	15.61	15.49	
	ISO3X 6G	15.179	14.943	15.56	15.62	15.50	
MF 18 × 1.5	ISO2X 6H	16.676	16.376	17.31	17.38	17.23	
	ISO3X 6G	16.708	16.408	17.34	17.41	17.26	
MF 20 × 1.5	ISO2X 6H	18.676	18.376	19.30	19.37	19.22	
	ISO3X 6G	18.708	18.408	19.34	19.41	19.26	

Miniature threads (S)

Unit: mm

Size	Recommended Hole Size	
	Max.	Min.
S 0.6 X 0.15	0.55	0.54
S 0.7 X 0.175	0.64	0.62
S 0.8 X 0.2	0.73	0.71
S 0.9 X 0.225	0.82	0.80

Unified Coarse Threads (UNC)

Unit: mm

No.	Size	Class	Minor Diameter		Drill Size	Recommended Hole Size	
			Max.	Min.		Max.	Min.
No. 1	1 - 64 UNC	2BX G4	1.582	1.425	1.71	1.75	1.67
No. 2	2 - 56 UNC	2BX G4	1.871	1.695	2.01	2.05	1.96
No. 3	3 - 48 UNC	2BX G4	2.146	1.941	2.30	2.35	2.25
No. 4	4 - 40 UNC	2BX G5	2.385	2.157	2.60	2.65	2.54
No. 5	5 - 40 UNC	2BX G5	2.697	2.487	2.92	2.97	2.87
No. 6	6 - 32 UNC	2BX G5	2.895	2.642	3.17	3.23	3.11
No. 8	8 - 32 UNC	2BX G6	3.530	3.302	3.84	3.89	3.78
No. 10	10 - 24 UNC	2BX G6	3.962	3.683	4.37	4.44	4.30
No. 12	12 - 24 UNC	2BX G6	4.597	4.344	5.02	5.08	4.96
	1/4 - 20 UNC	2BX G7	5.257	4.979	5.80	5.87	5.73
	5/16 - 18 UNC	2BX G7	6.731	6.401	7.31	7.39	7.22
	3/8 - 16 UNC	2BX G7	8.153	7.798	8.80	8.89	8.71
	7/16 - 14 UNC	2BX G8	9.550	9.144	10.30	10.40	10.20
	1/2 - 13 UNC	2BX G8	11.023	10.592	11.82	11.93	11.70

Unified Fine Threads (UNF)

Unit: mm

No.	Size	Class	Minor Diameter		Drill Size	Recommended Hole Size	
			Max.	Min.		Max.	Min.
No. 0	0 - 80 UNF	2BX G4	1.305	1.182	1.41	1.44	1.38
No. 1	1 - 72 UNF	2BX G4	1.612	1.474	1.73	1.76	1.69
No. 2	2 - 64 UNF	2BX G4	1.912	1.756	2.03	2.06	1.99
No. 3	3 - 56 UNF	2BX G4	2.197	2.025	2.33	2.37	2.29
No. 4	4 - 48 UNF	2BX G5	2.458	2.271	2.64	2.68	2.59
No. 5	5 - 44 UNF	2BX G5	2.740	2.551	2.95	2.99	2.90
No. 6	6 - 40 UNF	2BX G5	3.022	2.820	3.24	3.29	3.19
No. 8	8 - 36 UNF	2BX G5	3.606	3.404	3.86	3.91	3.81
No. 10	10 - 32 UNF	2BX G6	4.165	3.963	4.49	4.54	4.44
No. 12	12 - 28 UNF	2BX G6	4.724	4.496	5.09	5.14	5.03
	1/4 - 28 UNF	2BX G7	5.588	5.360	5.96	6.01	5.90
	5/16 - 24 UNF	2BX G7	7.035	6.782	7.48	7.54	7.41
	3/8 - 24 UNF	2BX G7	8.636	8.382	9.05	9.11	8.99
	7/16 - 20 UNF	2BX G8	10.033	9.729	10.55	10.63	10.47
	1/2 - 20 UNF	2BX G8	11.607	11.329	12.14	12.21	12.06

Cylindrical Pipe Threads - G(BSP)

Unit: mm

G	Size	Class	Minor Diameter		Drill Size	Recommended Hole Size	
			Max.	Min.		Max.	Min.
G	1/8 - 28	-	8.848	8.566	9.29	9.36	9.22
G	1/4 - 19	-	11.890	11.445	12.53	12.64	12.42
G	3/8 - 19	-	15.395	14.950	16.03	16.14	15.92
G	1/2 - 14	-	19.172	18.631	20.12	20.25	19.99

Helical Coil Wire Thread Inserts Metric Coarse (EG STI M)

Unit: mm

EG(STI)	M	Class	Minor Diameter		Drill Size	Recommended Hole Size		
			Max.	Min.		Max.	Min.	
EG(STI)	M	3 × 0.5	-	3.220	3.108	3.43	3.45	3.40
EG(STI)	M	4 × 0.7	-	4.292	4.152	4.59	4.63	4.56
EG(STI)	M	5 × 0.8	-	5.334	5.174	5.67	5.71	5.64
EG(STI)	M	6 × 1	-	6.407	6.217	6.84	6.89	6.80
EG(STI)	M	8 × 1.25	-	8.483	8.271	9.05	9.10	8.99
EG(STI)	M	10 × 1.5	-	10.560	10.324	11.25	11.31	11.19
EG(STI)	M	12 × 1.75	-	12.644	12.379	13.45	13.52	13.39

Helical Coil Wire Thread Inserts Metric Fine (EG STI MF)

Unit: mm

EG(STI)	MF	Class	Minor Diameter		Drill Size	Recommended Hole Size		
			Max.	Min.		Max.	Min.	
EG(STI)	MF	10 × 1.25		10.483	10.271	11.04	11.10	10.99
EG(STI)	MF	12 × 1.5		12.560	12.324	13.25	13.31	13.18
EG(STI)	MF	12 × 1.25		12.483	12.271	13.04	13.09	12.98

26. Bar diameter for cutting dies

Intro

Metric Threads (M, MF)

Unit: mm

	Size		Major diameter of external threads				Bar Diameter	
			ISO		old JIS		ISO	old JIS
			Max.	Min.	Max.	Min.		
SP	M1	× 0.25	1.000	0.933	0.985	0.940	0.95	0.95
SL	MF1	× 0.2	1.000	0.944	0.980	0.930	0.96	0.94
	M1.1	× 0.25	1.100	1.033	1.100	1.033	1.05	1.05
PO	MF1.1	× 0.2	1.100	1.044	1.100	1.044	1.06	1.06
	M1.2	× 0.25	1.200	1.133	1.185	1.140	1.15	1.15
ST	MF1.2	× 0.2	1.200	1.144	1.180	1.130	1.16	1.14
	M1.4	× 0.3	1.400	1.325	1.380	1.320	1.34	1.34
ROLL	MF1.4	× 0.2	1.400	1.344	1.380	1.330	1.36	1.34
	M1.6	× 0.35	1.581	1.496	1.581	1.496	1.52	1.52
CARBIDE	MF1.6	× 0.2	1.583	1.527	1.583	1.527	1.54	1.54
	M1.7	× 0.35	1.681	1.596	1.680	1.610	1.62	1.63
LONG	MF1.7	× 0.2	1.683	1.627	1.680	1.630	1.64	1.64
	M1.8	× 0.35	1.781	1.696	1.781	1.696	1.72	1.72
HAND TAPS	MF1.8	× 0.2	1.783	1.727	1.783	1.727	1.74	1.74
	M2	× 0.4	1.981	1.886	1.980	1.890	1.91	1.91
EG (STI)	MF2	× 0.25	1.982	1.915	1.980	1.930	1.93	1.94
	M2.2	× 0.45	2.180	2.080	2.180	2.080	2.11	2.11
SPECIAL THREADS, GAUGES	MF2.2	× 0.25	2.182	2.115	2.182	2.115	2.13	2.13
	M2.3	× 0.4	2.281	2.186	2.280	2.190	2.21	2.21
THREAD MILLS	MF2.3	× 0.25	2.282	2.215	2.280	2.230	2.23	2.24
	M2.5	× 0.45	2.480	2.380	2.480	2.380	2.41	2.41
DIES	MF2.5	× 0.35	2.481	2.396	2.481	2.396	2.42	2.42
	M2.6	× 0.45	2.580	2.480	2.580	2.480	2.51	2.51
CENTER DRILLS	MF2.6	× 0.35	2.581	2.496	2.580	2.480	2.52	2.51
	M3	× 0.5	2.980	2.874	2.980	2.874	2.90	2.90
	MF3	× 0.35	2.981	2.896	2.980	2.880	2.92	2.91
	M3.5	× 0.6	3.479	3.354	3.470	3.360	3.39	3.39
	MF3.5	× 0.35	3.481	3.396	3.480	3.380	3.42	3.41
	M4	× 0.7	3.978	3.838	3.978	3.838	3.87	3.87
	MF4	× 0.5	3.980	3.874	3.970	3.860	3.90	3.89
	M4.5	× 0.75	4.478	4.338	4.470	4.340	4.37	4.37
	MF4.5	× 0.5	4.480	4.374	4.470	4.360	4.40	4.39
	M5	× 0.8	4.976	4.826	4.976	4.826	4.86	4.86
	MF5	× 0.5	4.980	4.874	4.970	4.860	4.90	4.89
	M5.5	× 0.5	5.480	5.374	5.470	5.360	5.40	5.39
	M6	× 1	5.974	5.794	5.970	5.820	5.84	5.86
	MF6	× 0.75	5.978	5.838	5.970	5.850	5.87	5.88
	M7	× 1	6.974	6.794	6.970	6.820	6.84	6.86
	MF7	× 0.75	6.978	6.838	6.970	6.850	6.87	6.88
	M8	× 1.25	7.972	7.760	7.960	7.790	7.81	7.83
	MF8	× 1	7.974	7.794	7.970	7.830	7.84	7.87
	MF8	× 0.75	7.978	7.838	7.970	7.830	7.87	7.87
	M9	× 1.25	8.972	8.760	8.960	8.790	8.81	8.83
	MF9	× 1	8.974	8.794	8.970	8.830	8.84	8.87
	MF9	× 0.75	8.978	8.838	8.970	8.830	8.87	8.87
	M10	× 1.5	9.968	9.732	9.960	9.770	9.79	9.82
	MF10	× 1.25	9.972	9.760	9.960	9.810	9.81	9.85
	MF10	× 1	9.974	9.794	9.970	9.820	9.84	9.86
	MF10	× 0.75	9.978	9.838	9.978	9.838	9.87	9.87
	M11	× 1.5	10.968	10.732	10.968	10.732	10.79	10.79

	Size		Major diameter of external threads				Bar Diameter	
			ISO		old JIS		ISO	old JIS
			Max.	Min.	Max.	Min.		
	MF11	× 1	10.974	10.794	10.970	10.820	10.84	10.86
	MF11	× 0.75	10.978	10.838	10.978	10.838	10.87	10.87
	M12	× 1.75	11.966	11.701	11.950	11.760	11.8	11.8
	MF12	× 1.5	11.968	11.732	11.960	11.790	11.8	11.8
	MF12	× 1.25	11.972	11.760	11.972	11.760	11.8	11.8
	MF12	× 1	11.974	11.794	11.960	11.810	11.84	11.85
	M14	× 2	13.962	13.682	13.950	13.740	13.8	13.8
	MF14	× 1.5	13.968	13.732	13.960	13.790	13.8	13.8
	MF14	× 1	13.974	13.794	13.960	13.810	13.84	13.85
	MF15	× 1.5	14.968	14.732	14.960	14.790	14.8	14.8
	MF15	× 1	14.974	14.794	14.960	14.810	14.84	14.85
	M16	× 2	15.962	15.682	15.950	15.740	15.8	15.8
	MF16	× 1.5	15.968	15.732	15.960	15.790	15.8	15.8
	MF16	× 1	15.974	15.794	15.960	15.810	15.84	15.85
	MF17	× 1.5	16.968	16.732	16.968	16.732	16.8	16.8
	MF17	× 1	16.974	16.794	16.974	16.794	16.84	16.84
	M18	× 2.5	17.958	17.623	17.950	17.710	17.7	17.8
	MF18	× 2	17.962	17.682	17.950	17.650	17.8	17.7
	MF18	× 1.5	17.968	17.732	17.950	17.780	17.8	17.8
	MF18	× 1	17.974	17.794	17.960	17.810	17.84	17.85
	M20	× 2.5	19.958	19.623	19.950	19.710	19.7	19.8
	MF20	× 2	19.962	19.682	19.950	19.650	19.8	19.7
	MF20	× 1.5	19.968	19.732	19.950	19.780	19.8	19.8
	MF20	× 1	19.974	19.794	19.960	19.810	19.84	19.85
	M22	× 2.5	21.958	21.623	21.950	21.710	21.7	21.8
	MF22	× 2	21.962	21.682	21.950	21.650	21.8	21.7
	MF22	× 1.5	21.968	21.732	21.950	21.780	21.8	21.8
	MF22	× 1	21.974	21.794	21.960	21.810	21.84	21.85
	M24	× 3	23.952	23.577	23.940	23.680	23.7	23.7
	MF24	× 2	23.962	23.682	23.940	23.640	23.8	23.7
	MF24	× 1.5	23.968	23.732	23.950	23.780	23.8	23.8
	MF24	× 1	23.974	23.794	23.960	23.810	23.84	23.85
	MF25	× 2	24.962	24.682	24.940	24.640	24.8	24.7
	MF25	× 1.5	24.968	24.732	24.950	24.780	24.8	24.8
	MF25	× 1	24.974	24.794	24.960	24.810	24.84	24.85
	MF26	× 1.5	25.968	25.732	25.950	25.780	25.8	25.8
	M27	× 3	26.952	26.577	26.940	26.680	26.7	26.7
	MF27	× 2	26.962	26.682	26.962	26.682	26.8	26.8
	MF27	× 1.5	26.968	26.732	26.950	26.780	26.8	26.8
	MF27	× 1	26.974	26.794	26.974	26.794	26.84	26.84
	MF28	× 2	27.962	27.682	27.940	27.640	27.8	27.7
	MF28	× 1.5	27.968	27.732	27.950	27.780	27.8	27.8
	MF28	× 1	27.974	27.794	27.960	27.810	27.84	27.85
	M30	× 3.5	29.947	29.522	29.940	29.660	29.6	29.7
	MF30	× 3	29.952	29.577	29.952	29.577	29.7	29.7
	MF30	× 2	29.962	29.682	29.940	29.640	29.8	29.7
	MF30	× 1.5	29.968	29.732	29.950	29.780	29.8	29.8
	MF30	× 1	29.974	29.794	29.960	29.810	29.84	29.85
	MF32	× 2	31.962	31.682	31.940	31.640	31.8	31.7
	MF32	× 1.5	31.968	31.732	31.950	31.780	31.8	31.8

Technical info

Unit: mm

Size	Major diameter of external threads				Bar Diameter			
	ISO		old JIS		ISO	old JIS		
	Max.	Min.	Max.	Min.				
M33	×	3.5	32.947	32.522	32.940	32.660	32.6	32.7
MF33	×	3	32.952	32.577	32.952	32.577	32.7	32.7
MF33	×	2	32.962	32.682	32.962	32.682	32.8	32.8
MF33	×	1.5	32.968	32.732	32.950	32.780	32.8	32.8
MF35	×	1.5	34.968	34.732	34.950	34.780	34.8	34.8
M36	×	4	35.940	35.465	35.930	35.630	35.6	35.7
MF36	×	3	35.952	35.577	35.952	35.577	35.7	35.7
MF36	×	2	35.962	35.682	35.940	35.640	35.8	35.7
MF36	×	1.5	35.968	35.732	35.950	35.780	35.8	35.8
MF38	×	1.5	37.968	37.732	37.950	37.780	37.8	37.8
M39	×	4	38.940	38.465	38.930	38.630	38.6	38.7
MF39	×	3	38.952	38.577	38.952	38.577	38.7	38.7
MF39	×	2	38.962	38.682	38.962	38.682	38.8	38.8
MF39	×	1.5	38.968	38.732	38.968	38.732	38.8	38.8
MF40	×	3	39.952	39.577	39.952	39.577	39.7	39.7
MF40	×	2	39.962	39.682	39.940	39.640	39.8	39.7
MF40	×	1.5	39.968	39.732	39.950	39.780	39.8	39.8
M42	×	4.5	41.937	41.437	41.930	41.610	41.6	41.7
MF42	×	4	41.940	41.465	41.940	41.465	41.6	41.6
MF42	×	3	41.952	41.577	41.952	41.577	41.7	41.7
MF42	×	2	41.962	41.682	41.940	41.640	41.8	41.7
MF42	×	1.5	41.968	41.732	41.950	41.780	41.8	41.8
M45	×	4.5	44.937	44.437	44.930	44.610	44.6	44.7
MF45	×	4	44.940	44.465	44.940	44.465	44.6	44.6
MF45	×	3	44.952	44.577	44.952	44.577	44.7	44.7
MF45	×	2	44.962	44.682	44.940	44.640	44.8	44.7
MF45	×	1.5	44.968	44.732	44.950	44.780	44.8	44.8
M48	×	5	47.929	47.399	47.930	47.590	47.5	47.7
MF48	×	4	47.940	47.465	47.940	47.465	47.6	47.6
MF48	×	3	47.952	47.577	47.952	47.577	47.7	47.7
MF48	×	2	47.962	47.682	47.940	47.640	47.8	47.7
MF48	×	1.5	47.968	47.732	47.950	47.780	47.8	47.8

26. Bar diameter for cutting dies

Intro

Unified Threads (UNC/UNF) 2A class

Unit: mm

SP	Size	Major diameter of external threads		Bar Diameter
		Max.	Min.	
SL	No.0-80UNF	1.511	1.431	1.45
	No.1-64UNC	1.838	1.743	1.77
PO	No.1-72UNF	1.838	1.751	1.77
	No.2-56UNC	2.169	2.066	2.09
	No.2-64UNF	2.169	2.073	2.10
	No.3-48UNC	2.496	2.383	2.41
ST	No.3-56UNF	2.496	2.393	2.42
	No.4-40UNC	2.824	2.695	2.73
	No.4-48UNF	2.827	2.713	2.74
ROLL	No.5-40UNC	3.154	3.026	3.06
	No.5-44UNF	3.157	3.036	3.07
	No.6-32UNC	3.484	3.333	3.37
	No.6-40UNF	3.484	3.356	3.39
	No.8-32UNC	4.142	3.991	4.03
	No.8-36UNF	4.145	4.006	4.04
CARBIDE	No.10-24UNC	4.800	4.618	4.66
	No.10-32UNF	4.803	4.651	4.69
	No.12-24UNC	5.461	5.279	5.32
	No.12-28UNF	5.461	5.296	5.34
LONG	1/4-20UNC	6.322	6.117	6.17
	1/4-28UNF	6.324	6.160	6.20
	5/16-18UNC	7.907	7.687	7.74
	5/16-24UNF	7.909	7.727	7.77
	3/8-16UNC	9.491	9.254	9.31
	3/8-24UNF	9.497	9.315	9.36
HAND TAPS	7/16-14UNC	11.076	10.816	10.88
	7/16-20UNF	11.079	10.874	10.93
	1/2-13UNC	12.611	12.386	12.4
EG (STI)	1/2-20UNF	12.666	12.462	12.5
	9/16-12UNC	14.246	13.958	14.0
	9/16-18UNF	14.251	14.031	14.1
	5/8-11UNC	15.834	15.528	15.6
	5/8-18UNF	15.839	15.619	15.7
SPECIAL THREADS, GAUGES	3/4-10UNC	19.004	18.677	18.8
	3/4-16UNF	19.011	18.774	18.8
	7/8-9UNC	22.176	21.824	21.9
	7/8-14UNF	22.184	21.923	22.0
THREAD MILLS	1-8UNC	25.349	24.969	25.1
	1-12UNF	25.354	25.065	25.1
	1 1/8-7UNC	28.519	28.103	28.2
	1 1/8-12UNF	28.529	28.240	28.3
	1 1/4-7UNC	31.694	31.278	31.4
DIES	1 1/4-12UNF	31.704	31.415	31.5
	1 3/8-6UNC	34.864	34.402	34.5
	1 3/8-12UNF	34.876	34.588	34.7
	1 1/2-6UNC	38.039	37.577	37.7
CENTER DRILLS	1 1/2-12UNF	38.051	37.763	37.8
	1 3/4-5UNC	44.381	43.861	44.0
	2-4.5UNC	50.726	50.168	50.3

Technical info

Parallel pipe threads (PF - G) A class

Unit: mm

Size	Major diameter of external threads		Bar Diameter
	Max.	Min.	
PF 1/16 - 28	7.723	7.509	7.56
PF 1/8 - 28	9.728	9.514	9.57
PF 1/4 - 19	13.157	12.907	13.00
PF 3/8 - 19	16.662	16.412	16.50
PF 1/2 - 14	20.955	20.671	20.70
PF 5/8 - 14	22.911	22.627	22.70
PF 3/4 - 14	26.441	26.157	26.20
PF 7/8 - 14	30.201	29.917	30.00
PF 1 - 11	33.249	32.889	33.00
PF 1 1/8 - 11	37.897	37.537	37.60
PF 1 1/4 - 11	41.910	41.550	41.60
PF 1 1/2 - 11	47.803	47.443	47.50
PF 2 - 11	59.614	59.254	59.30

Taper Pipe Threads (PT. R)

Unit: mm

Size	Bar diameter	
	Taper (dia of threads end)	Straight
PT 1/16 - 28	7.5	7.9
PT 1/8 - 28	9.5	9.9
PT 1/4 - 19	12.8	13.4
PT 3/8 - 19	16.3	16.9
PT 1/2 - 14	20.5	21.3
PT 3/4 - 14	25.9	26.8
PT 1 - 11	32.7	33.7
PT 1 1/4 - 11	41.2	42.3
PT 1 1/2 - 11	47.1	48.2
PT 2 - 11	58.7	60.1

SP

SL

PO

ST

ROLL

CARBIDE

LONG

HAND
TAPS

EG (STI)











SPECIAL
THREADS,
GAUGESTHREAD
MILLS

DIES











CENTER
DRILLSTechnical
info

27. Lineup arranged by size

Intro

	M											Dies
SP	M1X0.25				J	J						D - J
	M1.1X0.25				J							D - J
	M1.2X0.25	J		J	J	J						D - J
SL	M1.4X0.3	J		D - J	J	J	J					D - J
	M1.6X0.35	J		D - J	J	J	J					D - J
	M1.7X0.35	J		J	J	J	J					D - J
	M1.8X0.35	J		J	J	J	J					D - J
PO	M2X0.4	D - J		D - J	D - J	D - J	J	J			J	D - J
	M2.2X0.45	D - J		D - J	J	J	J					D - J
	M2.3X0.4	J		D - J	J	J	J	J			J	D - J
	M2.5X0.45	D - J		D - J	D - J	D - J	J	J			J	D - J
ST	M2.6X0.45	D - J		D - J	J	J	J	J			J	D - J
	3M0.6	J		J	J						J	
	M3X0.5	D - J	D	D - J	D - J	D - J	D - J	J			D - J	D - J
	M3.5X0.6	D - J		D - J	J	D - J	J				J	D - J
ROLL	4M0.75	J		J	J						J	
	M4X0.7	D - J	D	D - J	D - J	D - J	D - J	J			D - J	D - J
	M4.5X0.75	J		J	J						J	
	5M0.9	J		J	J						J	
	M5X0.8	D - J	D	D - J	D - J	D - J	D - J	J			D - J	D - J
CARBIDE	M5.5X0.9	J		J	J						J	
	M6X1	D - J	D	D - J	D - J	D - J	D - J	J			D - J	D - J
	M7X1	D - J		D - J	J	J	J				J	D
	M8X1.25	D - J	D	D - J	D - J	D - J	D - J	J			D - J	D - J
	M9X1.25	D - J		D - J	J						J	D
LONG	M10X1.5	D - J	D	D - J	D - J	D - J	D - J	J			D - J	D - J
	M11X1.5	D - J		D - J	J							D
	M12X1.75	D - J	D	D - J	D - J	D - J	D - J	J			J	D
HAND TAPS	M14X2	D - J	D	D - J	D - J	D - J	D - J	J			J	D
	M16X2	D - J	D	D - J	D - J	D - J	D - J	J			J	D
	M18X2.5	D - J	D	D - J	D - J		D - J	J			J	D
	M20X2.5	D - J	D	D - J	D - J	J	D - J	J			J	D
	M22X2.5	D - J		D - J	D - J		J	J			J	D
EG (STI)	M24X3	D - J		D - J	D - J		J	J			J	D
	M27X3	D - J		D - J	J			J			J	D
	M30X3.5	D - J		D - J	J		J	J			J	D
	M33X3.5	D - J		D - J	J			J			J	D
SPECIAL THREADS, GAUGES	M36X4	D - J		D - J	J			J			J	D
	M39X4	D - J		D - J	J			J			J	
	M42X4.5	D - J		D - J	J			J			J	
	M45X4.5	D - J		D - J	J			J				
	M48X5	D - J		D - J	J			J				
THREAD MILLS	M52X5	J			J							
	M56X5.5	J			J							
	M60X5.5	J			J							
	M64X6	J			J							
DIES	M68X6				J							
	M70X6				J							
	M72X6				J							
	M76X6				J							
	M80X6				J							
CENTER DRILLS	M85X6				J							
	M90X6				J							
	M95X6				J							
	M100X6				J							

D = available in DIN standard, J = available in JIS standard, A = available in ANSI standard

MF											Dies
M1X0.2				J							
M1.1X0.2				J							
M1.2X0.2				J							
M1.4X0.2				J	J						
M1.6X0.2				J	J						
M1.7X0.2				J							
M1.8X0.2				J							
M2X0.25	J		J	J	J						D - J
M2.2X0.25			J	J							
M2.3X0.25	J			J							
M2.5X0.35	J		J	J	J						D - J
M2.6X0.35	J		J	J	J						J
M3X0.35	D - J		D - J	J	J	J					D - J
M3.5X0.35	J		J	J	J						
M4X0.5	D - J		D - J	J	J	J					D - J
M4.5X0.5	J		J	J							
M5X0.75	J			J							
M5X0.5	D - J		D - J	J	J	J					D - J
M5.5X0.75				J							
M5.5X0.5	J		J	J							
M6X0.75	D - J		D - J	J	J	J	J			J	D - J
M6X0.5	D - J		D - J	J	J	J					D - J
M6.5X0.5				J							
M7X0.75	D - J		D - J	J	J	J					D - J
M7X0.5	D - J		D - J	J							J
M7.5X0.5				J							
M8X1	D - J	D	D - J	D - J	J	J	J			J	D - J
M8X0.75	D - J		D - J	J	J	J	J			J	D - J
M8X0.5	D - J		D - J	J							D - J
M8.5X1				J							
M8.5X0.75				J							
M8.5X0.5				J							
M9X1	D - J		D - J	J						J	D - J
M9X0.75	J		J	J							J
M9X0.5	J		J	J							
M9.5X1				J							
M9.5X0.75				J							
M9.5X0.5				J							
M10X1.25	D - J	D	D - J	D - J	D - J	J	J			J	D - J
M10X1	D - J	D	D - J	D - J	J	J	J			J	D - J
M10X0.75	D - J		D - J	J			J				D
M10X0.5	J		J	J							D
M11X1.25	J		J	J							
M11X1	J		J	J							
M11X0.75	J		J	J							
M11X0.5			J	J							
M12X1.5	D - J	D	D - J	D - J	D - J	J	J			J	D
M12X1.25	D - J	D	D - J	D - J	D - J	J	J			J	D
M12X1	D - J		D - J	D - J	J	J	J			J	D
M12X0.75	J		J	J							D
M12X0.5	J		J	J							D
M13X1.75	J		J	J							
M13X1.5	J		J	J							
M13X1.25	J			J							
M13X1	J		J	J							

SP

SL

PO

ST

ROLL

CARBIDE

LONG

HAND TAPS

EG (STI)

SPECIAL THREADS, GAUGES

THREAD MILLS











DIES

CENTER DRILLS

Technical info











27. Lineup arranged by size

Intro

	MF											Dies
SP	M13X0.75			J	J							
	M13X0.5			J	J							
SL	M14X1.75				J							
	M14X1.5	D - J	D	D - J	D - J	D - J	J	J			J	D
	M14X1.25	D - J		D - J	J		J				J	D
	M14X1	D - J		D - J	J	J	J	J			J	D
PO	M14X0.75			J	J							
	M14X0.5			J	J							
	M15X2	J		J	J							
	M15X1.5	J		J	J							D
ST	M15X1.25				J							
	M15X1	J		J	J							
	M15X0.75				J							
	M15X0.5				J							
ROLL	M16X1.5	D - J	D	D - J	D - J	D - J	J	J			J	D
	M16X1.25	J		J	J							
	M16X1	D - J		D - J	J	J	J	J			J	D
	M16X0.75				J							
	M16X0.5				J							
CARBIDE	M17X2				J							
	M17X1.5	J		J	J							
	M17X1.25				J							
	M17X1	J		J	J							
	M17X0.75				J							
	M17X0.5				J							
LONG	M18X2	D - J		D - J	J			J			J	D
	M18X1.5	D - J	D	D - J	D - J	D - J	J	J			J	D
	M18X1.25	J		J	J							
	M18X1	D - J		D - J	J						J	D
HAND TAPS	M18X0.75				J							
	M18X0.5				J							
	M19X2.5				J							
	M19X2				J							
EG (STI)	M19X1.5	J		J	J							
	M19X1	J		J	J							
	M19X0.75				J							
	M19X0.5				J							
SPECIAL THREADS, GAUGES	M20X2	D - J		D - J	J			J			J	D
	M20X1.5	D - J	D	D - J	D - J	D - J	J	J			J	D
	M20X1.25	J			J							
	M20X1	D - J		D - J	J						J	D
	M20X0.75				J							
THREAD MILLS	M20X0.5				J							
	M21X2				J							
	M21X1.5				J							
	M21X1				J							
DIES	M22X2	D - J		D - J	J			J				D
	M22X1.5	D - J		D - J	D - J		J	J			J	D
	M22X1.25				J							
	M22X1	D - J		D - J	J							D
	M22X0.75				J							
CENTER DRILLS	M22X0.5				J							
	M23X2				J							
	M23X1.5	J			J							
	M23X1				J							

D = available in DIN standard, J = available in JIS standard, A = available in ANSI standard

Intro

MF											Dies
	SP	SL	PO	ST	ROLL	CARBIDE	LONG	HAND TAPS	EG (STI)	SPECIAL THREADS, GAUGES	Dies
M24X2	D - J		D - J	J			J			J	D
M24X1.5	D - J		D - J	D - J		J	J			J	D
M24X1.25				J							
M24X1	D - J		D - J	J							D
M24X0.75				J							
M24X0.5				J							
M25X3				J							
M25X2	J		J	J						J	
M25X1.5	D - J		D - J	J						J	
M25X1	J		J	J							
M26X3	J		J	J							
M26X2	J		J	J							
M26X1.5	D - J		D - J	J						J	D
M26X1	J		J	J							
M27X2	D - J		D - J	J			J			J	D
M27X1.5	D - J		D - J	J			J			J	D
M27X1	D - J		D - J	J							D
M28X3				J							
M28X2	D - J		D - J	J							D
M28X1.5	D - J		D - J	J						J	D
M28X1	D - J		D - J	J							
M29X1.5				J							
M30X3	D - J		J	J			J				
M30X2	D - J		D - J	J			J			J	
M30X1.5	D - J		D - J	J			J			J	D
M30X1	D - J		D - J	J							
M32X3.5				J							
M32X3	J		J	J							
M32X2	D - J		D - J	J							
M32X1.5	D - J		D - J	J							
M32X1	D - J		D	J							
M33X3	D - J		J	J			J				
M33X2	D - J		D - J	J			J				
M33X1.5	D - J		D - J	J			J				
M33X1	D - J		D	J							
M34X3	J			J							
M34X2	J		J	J							
M34X1.5	J		J	J							
M34X1	J			J							
M35X3	J			J							
M35X2	J		J	J							
M35X1.5	D - J		J	J							
M35X1	J			J							
M36X3	D - J		D - J	J			J				
M36X2	D - J		D - J	J			J				
M36X1.5	D - J		D - J	J			J				
M36X1	D - J		D	J							
M37X1.5				J							
M38X3	J			J							
M38X2	J		J	J							
M38X1.5	J		J	J							
M38X1				J							
M39X3	D - J		J	J			J				
M39X2	D - J		J	J			J				
M39X1.5	D - J		J	J			J				

SP

SL

PO

ST

ROLL

CARBIDE

LONG

HAND TAPS

EG (STI)

SPECIAL THREADS, GAUGES

THREAD MILLS











DIES

CENTER DRILLS

Technical info

27. Lineup arranged by size











Intro

	MF											Dies
SP	M39X1	D			J							
	M40X4				J							
SL	M40X3	J		J	J			J				
	M40X2	J		J	J			J				
	M40X1.5	J		J	J			J				
	M40X1				J							
	M42X4				J							
PO	M42X3	D - J		J	J			J				
	M42X2	D - J		J	J			J				
	M42X1.5	D - J		J	J			J				
	M42X1	D			J							
ST	M44X4				J							
	M44X3				J							
	M44X2				J							
	M44X1.5				J							
ROLL	M44X1				J							
	M45X4				J							
	M45X3	D - J		J	J			J				
	M45X2	D - J		J	J			J				
CARBIDE	M45X1.5	D - J		J	J			J				
	M45X1	D			J							
	M46X4				J							
	M46X3				J							
	M46X2				J							
	M46X1.5				J							
LONG	M48X4	J			J							
	M48X3	D - J		J	J			J				
	M48X2	D - J		J	J			J				
HAND TAPS	M48X1.5	D - J		J	J			J				
	M48X1	D			J							
	M50X5				J							
	M50X4				J							
	M50X3				J							
EG (STI)	M50X2				J							
	M50X1.5			J	J							
	M50X1				J							
SPECIAL THREADS, GAUGES	M52X4				J							
	M52X3				J							
	M52X2				J							
	M52X1.5				J							
	M55X4				J							
THREAD MILLS	M55X3				J							
	M55X2				J							
	M55X1.5				J							
	M56X4				J							
DIES	M56X3				J							
	M56X2				J							
	M56X1.5				J							
	M58X4				J							
CENTER DRILLS	M58X3				J							
	M58X2				J							
	M58X1.5				J							
	M60X4				J							
	M60X3				J							
	M60X2				J							

Technical info

D = available in DIN standard, **J** = available in JIS standard, **A** = available in ANSI standard

Intro

MF											Dies
	SP	SL	PO	ST	ROLL	CARBIDE	LONG	HAND TAPS	EG (STI)	SPECIAL THREADS, GAUGES	
M60X1.5				J							
M62X4				J							
M62X3				J							
M62X2				J							
M62X1.5				J							
M64X4				J							
M64X3				J							
M64X2				J							
M64X1.5				J							
M65X6				J							
M65X4				J							
M65X3				J							
M65X2				J							
M65X1.5				J							
M68X4				J							
M68X3				J							
M68X2				J							
M68X1.5				J							
M70X4				J							
M70X3				J							
M70X2				J							
M70X1.5				J							
M72X4				J							
M72X3				J							
M72X2				J							
M72X1.5				J							
M75X6				J							
M75X4				J							
M75X3				J							
M75X2				J							
M75X1.5				J							
M76X4				J							
M76X3				J							
M76X2				J							
M76X1.5				J							
M78X3				J							
M78X2				J							
M80X4				J							
M80X3				J							
M80X2				J							
M80X1.5				J							
M82X2				J							
M85X4				J							
M85X3				J							
M85X2				J							
M90X4				J							
M90X3				J							
M90X2				J							
M95X4				J							
M95X3				J							
M95X2				J							
M100X4				J							
M100X3				J							
M100X2				J							

SP

SL

PO

ST

ROLL

CARBIDE

LONG

HAND TAPS

EG (STI)

SPECIAL THREADS, GAUGES

THREAD MILLS





















DIES

CENTER DRILLS

Technical info









27. Lineup arranged by size

Intro

	UNC											Dies
SP	No.1-64UNC	J		J - A	J - A							D
	No.2-56UNC	J - A	A	J - A	J - A	J - A						D
	No.3-48UNC	J - A		J - A	J - A	J - A						D
SL	No.4-40UNC	D - J - A	A	D - J - A	J - A	J - A	J					D
	No.5-40UNC	D - J - A	A	D - J - A	J - A	J - A	J					D
	No.6-32UNC	D - J - A	A	D - J - A	J - A	J - A	J					D
	No.8-32UNC	D - J - A	A	D - J - A	J - A	J - A	J					D
PO	No.10-24UNC	D - J - A	A	D - J - A	J - A	J - A	J					D
	No.12-24UNC	D - J - A		D - J - A	J - A	J						D
	1/4-20UNC	D - J - A	A	D - J - A	D - J - A	J - A	J	J				D
	5/16-18UNC	D - J - A	A	D - J - A	D - J - A	J - A	J	J				D
ST	3/8-16UNC	D - J - A	A	D - J - A	D - J - A	A	J	J				D
	7/16-14UNC	D - J - A	A	D - J - A	D - J - A	J - A	J	J				D
	1/2-13UNC	D - J - A	A	D - J - A	D - J - A	J - A	J	J				D
	9/16-12UNC	D - J - A		D - J - A	D - J - A							D
ROLL	5/8-11UNC	D - J - A	A	D - J - A	D - J - A		J	J				D
	3/4-10UNC	D - J - A	A	D - J - A	D - J - A		J	J				D
	7/8-9UNC	D - J - A		D - J - A	D - J - A			J				D
	1-8UNC	D - J - A		D - J - A	D - J - A			J				D
	1 1/8-7UNC	D - J - A		D - J - A	J - A							
CARBIDE	1 1/4-7UNC	D - J - A		D - J - A	J - A							
	1 3/8-6UNC	D - J - A		D - J - A	J - A							
	1 1/2-6UNC	D - J - A		D - J - A	J - A							
	1 3/4-5UNC	D - J - A		D - A	J							
LONG	2-4.5UNC	D - J - A		A	J							
	UNF											Dies
HAND TAPS	No.0-80UNF			J - A	J - A	J - A						D
	No.1-72UNF			J - A	J - A	J						D
	No.2-64UNF	J - A		J - A	J - A	J						D
	No.3-56UNF	J - A		J - A	J - A	J - A						D
EG (STI)	No.4-48UNF	D - J - A		D - J - A	J - A	J - A	J					D
	No.5-44UNF	D - J - A		D - J - A	J - A	J						D
	No.6-40UNF	D - J - A		D - J - A	J - A	J						D
	No.8-36UNF	D - J - A		D - J - A	J - A	J						D
SPECIAL THREADS, GAUGES	No.10-32UNF	D - J - A	A	D - J - A	J - A	J - A	J					D
	No.12-28UNF	D - J - A		D - J - A	J - A	J						D
	1/4-28UNF	D - J - A	A	D - J - A	D - J - A	J - A	J	J				D
	5/16-24UNF	D - J - A	A	D - J - A	D - J - A	A	J	J				D
THREAD MILLS	3/8-24UNF	D - J - A	A	D - J - A	D - J - A	J - A	J	J				D
	7/16-20UNF	D - J - A	A	D - J - A	D - J - A	J - A	J	J				D
	1/2-20UNF	D - J - A	A	D - J - A	D - J - A	J - A	J	J				D
	9/16-18UNF	D - J - A		D - J - A	D - J - A			J				D
	5/8-18UNF	D - J - A	A	D - J - A	D - J - A		J	J				D
DIES	3/4-16UNF	D - J - A	A	D - J - A	D - J - A		J	J				D
	7/8-14UNF	D - J - A		D - J - A	D - J - A			J				D
	1-12UNF	D - J - A		D - J - A	D - J - A			J				D
	1 1/8-12UNF	D - J - A		D - J - A	J - A							
	1 1/4-12UNF	D - J - A		D - J - A	J - A							
CENTER DRILLS	1 3/8-12UNF	D - J - A		D - J - A	J - A							
	1 1/2-12UNF	D - J - A		D - J - A	J - A							

D = available in DIN standard, J = available in JIS standard, A = available in ANSI standard

Technical info

UNS											Dies
7/16-24UNS				J							
1/2-24UNS				J							
1-14UNS	J		J	J							
1 1/16-14UNS				J							
1 1/8-14UNS	J										
1 5/8-5UNS				J							
8UN											Dies
1 1/8-8UN	D - J			J							
1 1/4-8UN	D - J			J							
1 3/8-8UN	D - J			J							
1 1/2-8UN	D - J			J							
1 5/8-8UN	D			J							
1 3/4-8UN	D			J							
1 7/8-8UN				J							
2-8UN	D			J							
2 1/4-8UN				J							
2 1/2-8UN				J							
2 3/4-8UN				J							
3-8UN				J							
12UN											Dies
1 1/16-12UN				J							
1 3/16-12UN				J							
1 5/16-12UN				J							
1 5/8-12UN				J							
1 3/4-12UN	D - J			J							
1 7/8-12UN				J							
2-12UN	J			J							
20UN											Dies
9/16-20UN				J							
5/8-20UN				J							
32UN											Dies
1/2-32UN				J							
UNEF											Dies
No.12-32UNEF				J							
1/4-32UNEF	J		J	J							
5/16-32UNEF	J		J	J							
3/8-32UNEF	J		J	J							
7/16-28UNEF	J		J	J							
1/2-28UNEF	J		J	J							

SP

SL

PO

ST

ROLL

CARBIDE

LONG

HAND TAPS

EG (STI)

SPECIAL THREADS, GAUGES

THREAD MILLS



















































DIES

CENTER DRILLS











Technical info

27. Lineup arranged by size

Intro

	UNE F											Dies
SP		SP	SL	PO	ST	ROLL	CARBIDE	LONG	HAND TAPS	EG (STI)	SPECIAL THREADS, GAUGES	Dies
	9/16-24UNE F	J			J							
	5/8-24UNE F	J		J	J							
SL		J		J	J							
	3/4-20UNE F	J		J	J							
	7/8-20UNE F	J			J							
	1-20UNE F	J			J							
	G(BSP)											Dies
PO		SP	SL	PO	ST	ROLL	CARBIDE	LONG	HAND TAPS	EG (STI)	SPECIAL THREADS, GAUGES	Dies
	1/16-28	D		D								
	1/8-28	D		D	D - J	D	J	J				D
ST		D		D	D - J	D	J	J				D
	1/4-19	D		D	D - J	D	J	J				D
	3/8-19	D		D	D - J	D	D - J	J				D
	1/2-14	D		D	D - J		J	J				D
	5/8-14	D		D								D
ROLL		D		D	D - J		J	J				D
	3/4-14	D		D	D - J		J	J				D
	7/8-14	D		D								D
	1-11	D		D	D - J		J	J				D
	1 1/8-11	D		D								
	1 1/4-11	D		D	J			J				D
CARBIDE		D		D	J			J				D
	1 1/2-11	D		D	J			J				D
	2-11				J			J				
	Rp(BSPP)											Dies
LONG		SP	SL	PO	ST	ROLL	CARBIDE	LONG	HAND TAPS	EG (STI)	SPECIAL THREADS, GAUGES	Dies
	1/8-28	D						J				
	1/4-19	D						J				
HAND TAPS		D						J				
	3/8-19	D						J				
	1/2-14	D						J				
	3/4-14	D						J				
	1-11	D						J				
	1 1/4-11							J				
EG (STI)								J				
	1 1/2-11							J				
	Rc(BSPT)											Dies
SPECIAL THREADS, GAUGES		SP	SL	PO	ST	ROLL	CARBIDE	LONG	HAND TAPS	EG (STI)	SPECIAL THREADS, GAUGES	Dies
	1/16-28	D						J				
	1/8-28	D			D			J				
THREAD MILLS		D			D			J				
	1/4-19	D			D			J				
	3/8-19	D			D			J				
	1/2-14	D			D			J				
	3/4-14	D			D			J				
	1-11	D			D			J				
	1 1/4-11							J				
DIES								J				
	1 1/2-11							J				
	2-11							J				
	NPT											Dies
CENTER DRILLS		SP	SL	PO	ST	ROLL	CARBIDE	LONG	HAND TAPS	EG (STI)	SPECIAL THREADS, GAUGES	Dies
	1/16-27	D - A			A			J				
	1/8-27	D - A			A			J				D











D = available in DIN standard, J = available in JIS standard, A = available in ANSI standard

NPT											Dies
	SP	SL	PO	ST	ROLL	CARBIDE	LONG	HAND TAPS	EG (STI)	SPECIAL THREADS, GAUGES	
1/4-18	D - A			A			J				D
3/8-18	D - A			A			J				D
1/2-14	D - A			A			J				D
3/4-14	D - A			A			J				D
1 -11 1/2	D - A			A			J				D
1 1/4-11 1/2				A							
1 1/2-11 1/2				A							
2-11 1/2				A							

SP

SL











PO

NPTF											Dies
	SP	SL	PO	ST	ROLL	CARBIDE	LONG	HAND TAPS	EG (STI)	SPECIAL THREADS, GAUGES	
1/16-27	A			A			J				
1/8-27	A			A			J				
1/4-18	A			A			J				
3/8-18	A			A			J				
1/2-14	A			A			J				
3/4-14	A			A			J				
1 -11 1/2	A			A			J				
1 1/4-11 1/2				A							
1 1/2-11 1/2				A							
2-11 1/2				A							

ST











ROLL

CARBIDE

NPS											Dies
	SP	SL	PO	ST	ROLL	CARBIDE	LONG	HAND TAPS	EG (STI)	SPECIAL THREADS, GAUGES	
1/8-27				A							
1/4-18				A							
3/8-18				A							
1/2-14				A							
3/4-14				A							
1 -11 1/2				A							

LONG











HAND TAPS

NPSF											Dies
	SP	SL	PO	ST	ROLL	CARBIDE	LONG	HAND TAPS	EG (STI)	SPECIAL THREADS, GAUGES	
1/8-27				A							
1/4-18				A							
3/8-18				A							
1/2-14				A							
3/4-14				A							
1 -11 1/2				A							

EG (STI)

SPECIAL THREADS, GAUGES

THREAD MILLS

BSW											Dies
	SP	SL	PO	ST	ROLL	CARBIDE	LONG	HAND TAPS	EG (STI)	SPECIAL THREADS, GAUGES	
1/16W60				J							
3/32W48				J							
1/8W40	J		J	J						J	
5/32W32	J		J	J						J	
3/16W24	J		J	J						J	
7/32W24	J		J	J						J	
1/4W20	J		J	J			J			J	
5/16W18	J		J	J			J			J	































DIES

CENTER DRILLS

Technical info

27. Lineup arranged by size

Intro











	BSW											Dies
SP	3/8W16	J		J	J			J			J	
	7/16W14	J		J	J			J			J	
SL	1/2W12	J		J	J			J			J	
	9/16W12	J		J	J						J	
	5/8W11	J		J	J			J			J	
	3/4W10	J		J	J			J			J	
	7/8W9	J		J	J			J			J	
PO	1 W8	J		J	J			J			J	
	1 1/8W7	J		J	J						J	
	1 1/4W7	J		J	J						J	
	1 3/8W6	J		J	J						J	
ST	1 1/2W6	J		J	J						J	
	1 5/8W5	J			J							
	1 3/4W5	J			J							
	1 7/8W4 1/2	J			J							
ROLL	2 W4 1/2	J		J	J							
	2 1/4W4				J							
	2 1/2W4				J							
	2 3/4W3 1/2				J							
	3 W3 1/2				J							
CARBIDE	3 1/4W3 1/4				J							
	3 1/2W3 1/4				J							
	3 3/4W3				J							
	4 W3				J							
	EG(STI) M											Dies
HAND TAPS	STI M2.6X0.45									J		
	STI M3X0.5									J		
	STI M4X0.7									J		
	STI M5X0.8									J		
	STI M6X1									J		
EG (STI)	STI M8X1.25									J		
	STI M10X1.5									J		
	STI M12X1.75									J		
	STI M14X2									J		
SPECIAL THREADS, GAUGES	STI M16X2									J		
	STI M18X2.5									J		
	STI M20X2.5									J		
	STI M22X2.5									J		
	STI M24X3									J		
	EG(STI) MF											Dies
DIES	STI M10X1									J		
	STI M10X1.25									J		
	STI M12X1.25									J		
	STI M12X1.5									J		
CENTER DRILLS	STI M14X1.25									J		
	STI M14X1.5									J		
	STI M16X1.5									J		
	STI M18X1.5									J		
	STI M20X1.5									J		

D = available in DIN standard, J = available in JIS standard, A = available in ANSI standard



Technical info

Intro

EG(STI) MF											Dies
STI M22X1.5									J		
STI M24X1.5									J		
STI M24X2									J		

SP

SL

PO

ST

ROLL

CARBIDE

LONG

HAND TAPS

EG (STI)











SPECIAL THREADS, GAUGES











THREAD MILLS











DIES











CENTER DRILLS

Technical info

EG(STI) UNC											Dies
STI No.2-56UNC									A		
STI No.4-40UNC									J - A		
STI No.5-40UNC									J		
STI No.6-32UNC									J - A		
STI No.8-32UNC									J - A		
STI No.10-24UNC									J - A		
STI No.12-24UNC									J		
STI 1/4-20UNC									J - A		
STI 5/16-18UNC									J - A		
STI 3/8-16UNC									J - A		
STI 7/16-14UNC									J - A		
STI 1/2-13UNC									J - A		
STI 5/8-11UNC									J		
STI 3/4-10UNC									J		



















































EG(STI) UNF											Dies
STI No.4-48UNF									J		
STI No.6-40UNF									J - A		
STI No.8-36UNF									J		
STI No.10-32UNF									J - A		
STI 1/4-28UNF									J - A		
STI 5/16-24UNF									J - A		
STI 3/8-24UNF									J - A		
STI 7/16-20UNF									J - A		
STI 1/2-20UNF									J - A		
STI 5/8-18UNF									J		
STI 3/4-16UNF									J		

Pg											Dies
Pg 7										D	
Pg 9										D	
Pg 11										D	
Pg 13.5										D	
Pg 16										D	
Pg 21										D	
Pg 29										D	
Pg 36										D	

Tr											Dies
TR10X2										J	
TR12X3										J	











27. Lineup arranged by size

Intro

SP	Tr											Dies
	TR12X2										J	
	TR14X3										J	
SL	TR16X4										J	
	TR16X3										J	
	TR18X4										J	
	TR20X4										J	
	TR22X5										J	
PO	TR24X5										J	
	TR25X5										J	
	TR26X5										J	
	TR28X5										J	
ST	TR30X6										J	
ROLL	S Miniature											Dies
	S0.4X0.1										J	
	S0.5X0.125										J	
	S0.6X0.15										J	
CARBIDE	S0.7X0.175										J	
	S0.8X0.2										J	
	S0.9X0.225										J	
LONG	TRI											Dies
	1/4-20										J	
HAND TAPS	RLS											Dies
	3.4X0.5X28°										J	
EG (STI)	V											Dies
SPECIAL THREADS, GAUGES	5V1										J	
	8V2										J	
	8V1										J	
THREAD MILLS	9V1										J	
	10V1										J	
	10V2										J	
	11V1										J	
	12V1										J	
DIES	13V1										J	
	13V2										J	
	15V1										J	
CENTER DRILLS	16V1										J	
	17V1										J	
	17V3										J	
	17V2										J	
	19V1										J	
	20V1										J	

D = available in DIN standard, J = available in JIS standard, A = available in ANSI standard

Intro

CTV											Dies
	SP	SL	PO	ST	ROLL	CARBIDE	LONG	HAND TAPS	EG (STI)	SPECIAL THREADS, GAUGES	Dies
CTV5-24										J	
5V2										J	
CTV5-36										J	
6V1										J	
CTV8-32										J	
CTV8-30										J	

SP

SL

PO

ST

ROLL

CARBIDE

LONG

HAND TAPS

EG (STI)











SPECIAL THREADS, GAUGES











THREAD MILLS











DIES

CENTER DRILLS

Technical info

BC											Dies
	SP	SL	PO	ST	ROLL	CARBIDE	LONG	HAND TAPS	EG (STI)	SPECIAL THREADS, GAUGES	Dies
BC 5/16-26										J	
BC 3/8-26										J	
BC 7/16-26										J	
BC 1/2-20										J	
BC 9/16-20										J	
BC 5/8-20										J	
BC 11/16-24										J	
BC 3/4-30										J	
BC 31/32-30										J	
BC 1-24										J	
BC 1.29-24										J	
BC 1.37-24										J	
BC 1 7/16-24										J	
BC 1.45-24										J	
BC 1 9/16-24										J	

CTC											Dies
	SP	SL	PO	ST	ROLL	CARBIDE	LONG	HAND TAPS	EG (STI)	SPECIAL THREADS, GAUGES	Dies
CTC19-16										J	
CTC25-16										J	
CTC31-16										J	
CTC39-16										J	

CTG											Dies
	SP	SL	PO	ST	ROLL	CARBIDE	LONG	HAND TAPS	EG (STI)	SPECIAL THREADS, GAUGES	Dies
CTG16-14										J	
CTG22-14										J	
CTG28-11										J	
CTG36-11										J	
CTG42-11										J	

28. List of work materials

Intro

Gr.	Materials	W.-Nr	DIN	EN-Nr.	EN	UNI	BS	JIS	AFNOR	
SP	Free cutting steel and structural steel Rm < 500 N/mm ²	1.0037	St 37-2	1.0037	S235JR	Fe 360 B		STKM 12 C	E 24-2	
		1.0116	St 37-3	1.0038	S235JRG2	Fe 360 D FF	4360-40 C		E 24-3, E 24-4	
		1.0144	St 44-3 N	1.0144	S275J2G3	Fe 430 D FF	4360-43 C	SM 41 C	E 28-3, E 28-4	
		1.0301	C 10	1.0301	C 10	C 10	045 M 10	S 10 C	34 C 10, XC 10	
		1.0401	C 15			C 15, C 16	080 M 15		37 C 12, XC 18	
		1.0402	C 22	1.0402	C 22	C 20, C 21	050 A 20		C 20	
		1.0570	St 52-3	1.0570	S355JR	Fe 510 B	4360-50 C	SM 50 YA	E 36-3, E 36-4	
		1.0715	9 SMn 28	1.0715	11 SMn 30	CF 9 SMn 28	230 M 07	SUM 22	S 250	
		1.0718	9 SMnPb 28	1.0718	11 SMnPb 30	CF 9 SMnPb 28		SUM 22 L	S 250 Pb	
		1.0721	10 S 20	1.0721	10 S 20	CF 10 S 20	210 M 15		10 F 1	
		1.0722	10 SPb 20			CF 10 SPb 20			10 Pbf 2	
		1.0723	15 S 20	1.0725	15 SMn 13			210 A 15	SUM 32	
		1.0726	35 S 20	1.0726	35 S 20			212 M 36		35 MF 4
		1.0727	46 S 20	1.0727	46 S 20			212 M 44		45 MF 4
		1.0736	9 SMn 36	1.0736	11 SMn 37	CF 9 SMn 36	240 M 07			S 300
		1.0765	36 SMnPb 14		36 SMnPb 14	CF 35 SMnPb 10	216 M 36			35 MF 6 Pb
		1.1141	Ck 15	1.1141	C 15R	C 15, C 16	080 M 15	S 15 C, S 15 CK		XC 15, XC 18
	Ck 25			C 25	060 A 25	S 25 C		XC 25		
ROLL	Carbon steel and low alloy steel Rm 500÷700 N/mm ²	1.0501	C 35		C 35	C 35	060 A 35		55 C 35	
		1.0503	C 45	1.0503	E 335	C 45	80 M 46	S 45 C	65 C 45	
		1.0511	C 40		C 40	C 40	080 M 40	S 40 C	60 C 40	
		1.0535	St 70-2	1.0070	E 360	Fe 690			A 70-2	
		1.0601	C 60	1.0601	C 60	C 60	080 A 62		CC 55	
		1.1157	40 Mn 4				150 M 36		35 M 5	
		1.1165	30 Mn 5	1.1165	G 28 Mn 6		120 M 36	SMn 1 H, SCMn 2		
		1.1181	Ck 35	1.1181	C 35E	C 35	080 M 36	S 35 C		XC 38 H1
		1.1191	Ck 45	1.1191	C 45E	C 45	080 M 46	S 45 C		XC 42
		1.1221	Ck 60	1.1221	C 60E	C 60	080 A 62	S 58 C		XC 60
		1.1740	C 60 W					SK 7		Y3 55
		1.2162	21 MnCr 5					SCR 420 H		20 NC 5
		1.5415	15 Mo 3	1.5415	16 Mo 3	16 Mo 3	1501-240			15 D 3
		1.5423	16 Mo 5			16 Mo 5	1503-245-420	SB 450 M		
		1.5752	14 NiCr 14	1.5752	14 NiCr 14		655 M 13	SNC 815 (H)		12 NC 15
		1.5919	15 CrNi 6			16 CrNi 4	S 107			16 NC 6
		1.6587	18 CrNiMo 7 6	1.6587	18 NiCrMo 7 6	18 NiCrMo 7	820 A 16			18 NCD 6
1.7131	16 MnCr 5	1.7131	16 MnCr 5	16 MnCr 5	527 M 17	SCR 415		16 MC 5		
1.7139	16 MnCrS 5	1.7139	16 MnCrS 5							
1.7147	20 MnCr 5	1.7147	20 MnCr 5	20 MnCr 5		SMnC 420 (H)		20 MC 5		
1.7149	20 MnCrS 5	1.7149	20 MnCrS 5			SMnC 21 H		20 MnCrS 5		
1.7335	13 CrMo 4 4	1.7335	13 CrMo 4 5	14 CrMo 4 5	1501-620 Gr. 27			15 CD 3.5		
1.7337	16 CrMo 4 4			14 CrMo 4 5	1501-620 Gr. 27			15 CD 4.5		
1.7380	10 CrMo 9 10	1.7380	10 CrMo 9 10	12 CrMo 9 10	1501-622 Gr. 31			10 CD 9.10		
LONG	Medium alloy steel Rm 600÷800 N/mm ²	1.0904	55 Si 7	1.7100	55 SiCr7	55 Si 8	250 A 53		55 S 7	
		1.2330	35 CrMo 4			35 CrMo 4	708 A 37		34 CD 4	
		1.2542	45 WCrV 7			45 WCrV 8 KU	BS 1			
		1.2714	56 NiCrMoV 7	1.2714		56 NiCrMoV7-KU	BH 224-5	SKT 4		
		1.5121	46 MnSi 4							
		1.5710	36 NiCr 6				640 A 35	SNC 236		35 NC 6
		1.5736	36 NiCr 10			35 NiCr 9		SNC 631 (H)		35 NC 11
		1.6511	36 CrNiMo 4		36 CrNiMo 4	38 NiCrMo 4 (KB)	816 M 40			40 NCD 3
		1.6582	34 CrNiMo 6	1.6582	34 CrNiMo 6	35 NiCrMo 6 (KW)	817 M 40	SNCM 447		35 NCD 6
		1.7033	34 Cr 4	1.7033	34 Cr 4	34 Cr 4 (KB)	530 A 32	SCR 430 (H)		32 C 4
		1.7035	41 Cr 4	1.7035	41 Cr 4	41 Cr 4	530 M 40	SCR 440 (H)		42 C 4
		1.7218	25 CrMo 4	1.7218	25 CrMo 4	25 CrMo 4 (KB)	708 M 25	SCM 425		25 CD 4 S
		1.7225	42 CrMo 4	1.7225	42 CrMo 4	42 CrMo 4	708 M 40	SCM 440 (H)		42 CD 4
		1.7361	32 CrMo 12			32 CrMo 12	722 M 24			30 CD 12
		1.8159	50 CrV 4	1.8159	50 CrV 4	51 CrV 4	735 A 50	SUP 10		50 CV 4
		1.8509	41 CrAlMo 7	1.8509	41 CrAlMo 7 10	41 CrAlMo 7	905 M 39	SACM 645		40 CAD 6.12
		HAND TAPS	Medium alloy steel Rm 600÷800 N/mm ²	1.0904	55 Si 7	1.7100	55 SiCr7	55 Si 8	250 A 53	
1.2330	35 CrMo 4					35 CrMo 4	708 A 37		34 CD 4	
1.2542	45 WCrV 7					45 WCrV 8 KU	BS 1			
1.2714	56 NiCrMoV 7			1.2714		56 NiCrMoV7-KU	BH 224-5	SKT 4		
1.5121	46 MnSi 4									
1.5710	36 NiCr 6						640 A 35	SNC 236		35 NC 6
1.5736	36 NiCr 10					35 NiCr 9		SNC 631 (H)		35 NC 11
1.6511	36 CrNiMo 4				36 CrNiMo 4	38 NiCrMo 4 (KB)	816 M 40			40 NCD 3
1.6582	34 CrNiMo 6			1.6582	34 CrNiMo 6	35 NiCrMo 6 (KW)	817 M 40	SNCM 447		35 NCD 6
1.7033	34 Cr 4			1.7033	34 Cr 4	34 Cr 4 (KB)	530 A 32	SCR 430 (H)		32 C 4
1.7035	41 Cr 4			1.7035	41 Cr 4	41 Cr 4	530 M 40	SCR 440 (H)		42 C 4
1.7218	25 CrMo 4			1.7218	25 CrMo 4	25 CrMo 4 (KB)	708 M 25	SCM 425		25 CD 4 S
1.7225	42 CrMo 4			1.7225	42 CrMo 4	42 CrMo 4	708 M 40	SCM 440 (H)		42 CD 4
1.7361	32 CrMo 12					32 CrMo 12	722 M 24			30 CD 12
1.8159	50 CrV 4			1.8159	50 CrV 4	51 CrV 4	735 A 50	SUP 10		50 CV 4
1.8509	41 CrAlMo 7			1.8509	41 CrAlMo 7 10	41 CrAlMo 7	905 M 39	SACM 645		40 CAD 6.12
EG (STI)	Medium alloy steel Rm 600÷800 N/mm ²			1.0904	55 Si 7	1.7100	55 SiCr7	55 Si 8	250 A 53	
		1.2330	35 CrMo 4			35 CrMo 4	708 A 37		34 CD 4	
		1.2542	45 WCrV 7			45 WCrV 8 KU	BS 1			
		1.2714	56 NiCrMoV 7	1.2714		56 NiCrMoV7-KU	BH 224-5	SKT 4		
		1.5121	46 MnSi 4							
		1.5710	36 NiCr 6				640 A 35	SNC 236		35 NC 6
		1.5736	36 NiCr 10			35 NiCr 9		SNC 631 (H)		35 NC 11
		1.6511	36 CrNiMo 4		36 CrNiMo 4	38 NiCrMo 4 (KB)	816 M 40			40 NCD 3
		1.6582	34 CrNiMo 6	1.6582	34 CrNiMo 6	35 NiCrMo 6 (KW)	817 M 40	SNCM 447		35 NCD 6
		1.7033	34 Cr 4	1.7033	34 Cr 4	34 Cr 4 (KB)	530 A 32	SCR 430 (H)		32 C 4
		1.7035	41 Cr 4	1.7035	41 Cr 4	41 Cr 4	530 M 40	SCR 440 (H)		42 C 4
		1.7218	25 CrMo 4	1.7218	25 CrMo 4	25 CrMo 4 (KB)	708 M 25	SCM 425		25 CD 4 S
		1.7225	42 CrMo 4	1.7225	42 CrMo 4	42 CrMo 4	708 M 40	SCM 440 (H)		42 CD 4
		1.7361	32 CrMo 12			32 CrMo 12	722 M 24			30 CD 12
		1.8159	50 CrV 4	1.8159	50 CrV 4	51 CrV 4	735 A 50	SUP 10		50 CV 4
		1.8509	41 CrAlMo 7	1.8509	41 CrAlMo 7 10	41 CrAlMo 7	905 M 39	SACM 645		40 CAD 6.12
		SPECIAL THREADS, GAUGES	Medium alloy steel Rm 600÷800 N/mm ²	1.0904	55 Si 7	1.7100	55 SiCr7	55 Si 8	250 A 53	
1.2330	35 CrMo 4					35 CrMo 4	708 A 37		34 CD 4	
1.2542	45 WCrV 7					45 WCrV 8 KU	BS 1			
1.2714	56 NiCrMoV 7			1.2714		56 NiCrMoV7-KU	BH 224-5	SKT 4		
1.5121	46 MnSi 4									
1.5710	36 NiCr 6						640 A 35	SNC 236		35 NC 6
1.5736	36 NiCr 10					35 NiCr 9		SNC 631 (H)		35 NC 11
1.6511	36 CrNiMo 4				36 CrNiMo 4	38 NiCrMo 4 (KB)	816 M 40			40 NCD 3
1.6582	34 CrNiMo 6			1.6582	34 CrNiMo 6	35 NiCrMo 6 (KW)	817 M 40	SNCM 447		35 NCD 6
1.7033	34 Cr 4			1.7033	34 Cr 4	34 Cr 4 (KB)	530 A 32	SCR 430 (H)		32 C 4
1.7035	41 Cr 4			1.7035	41 Cr 4	41 Cr 4	530 M 40	SCR 440 (H)		42 C 4
1.7218	25 CrMo 4			1.7218	25 CrMo 4	25 CrMo 4 (KB)	708 M 25	SCM 425		25 CD 4 S
1.7225	42 CrMo 4			1.7225	42 CrMo 4	42 CrMo 4	708 M 40	SCM 440 (H)		42 CD 4
1.7361	32 CrMo 12					32 CrMo 12	722 M 24			30 CD 12
1.8159	50 CrV 4			1.8159	50 CrV 4	51 CrV 4	735 A 50	SUP 10		50 CV 4
1.8509	41 CrAlMo 7			1.8509	41 CrAlMo 7 10	41 CrAlMo 7	905 M 39	SACM 645		40 CAD 6.12
DIES	Medium alloy steel Rm 600÷800 N/mm ²			1.0904	55 Si 7	1.7100	55 SiCr7	55 Si 8	250 A 53	
		1.2330	35 CrMo 4			35 CrMo 4	708 A 37		34 CD 4	
		1.2542	45 WCrV 7			45 WCrV 8 KU	BS 1			
		1.2714	56 NiCrMoV 7	1.2714		56 NiCrMoV7-KU	BH 224-5	SKT 4		
		1.5121	46 MnSi 4							
		1.5710	36 NiCr 6				640 A 35	SNC 236		35 NC 6
		1.5736	36 NiCr 10			35 NiCr 9		SNC 631 (H)		35 NC 11
		1.6511	36 CrNiMo 4		36 CrNiMo 4	38 NiCrMo 4 (KB)	816 M 40			40 NCD 3
		1.6582	34 CrNiMo 6	1.6582	34 CrNiMo 6	35 NiCrMo 6 (KW)	817 M 40	SNCM 447		35 NCD 6
		1.7033	34 Cr 4	1.7033	34 Cr 4	34 Cr 4 (KB)	530 A 32	SCR 430 (H)		32 C 4
		1.7035	41 Cr 4	1.7035	41 Cr 4	41 Cr 4	530 M 40	SCR 440 (H)		42 C 4
		1.7218	25 CrMo 4	1.7218	25 CrMo 4	25 CrMo 4 (KB)	708 M 25	SCM 425		25 CD 4 S
		1.7225	42 CrMo 4	1.7225	42 CrMo 4	42 CrMo 4	708 M 40	SCM 440 (H)		42 CD 4
		1.7361	32 CrMo 12			32 CrMo 12	722 M 24			30 CD 12
		1.8159	50 CrV 4	1.8159	50 CrV 4	51 CrV 4	735 A 50	SUP 10		50 CV 4
		1.8509	41 CrAlMo 7	1.8509	41 CrAlMo 7 10	41 CrAlMo 7	905 M 39	SACM 645		40 CAD 6.12
		CENTER DRILLS	Medium alloy steel Rm 600÷800 N/mm ²	1.0904	55 Si 7	1.7100	55 SiCr7	55 Si 8	250 A 53	

SS	UNS	U.N.E. / I.H.A.	AISI-ASTM	GOST	ČSN	Trade Mark	Structure
1311				16D			
1312, 1313			A573 Grade 58	18kp	11 378		
1412, 1414			A573 Grade 70	St14kP	11 448		
	G10100		1010	10			
1350	G10170	F.1110	1015	15			
1450	G10200		1020, 1023	20	12 024		
2172, 2132				17G15	11 523		
1912	G12130		1213			AVP	
1914	G12134		12 L 13				
			1108				
			11 L 08				
1922							
1957	G11400		1140	40			
1973	G11460		1146				
	G12150		12 L14			AVZ	
			11 L 37	A535G2		PR80	
1370	G10170	F.1511	1015	15			
	G10250	F.1120	1025	25			
1550	G10350	F.1130	1035	35	12 040		
1650	G10430	F.5110	1045	45	12 050		
			1040	40	12 041		
1655		F.1150	1055	55			
	G10600		1060	60	12 061		
	G10390		1039	40G			
	G13300		1330	30G2			
1572	G10340	F.1135	1035	35			
1672	G10420	F.1140	1045	45	12 050		
1665, 1678	G10640	F.1150	1064	60			
			1060	60			
2912			A204 Grade A		15 020		
	G45200		4520				
	G33106		3310, 9314	20X2H4A	16 420		
			4320		16 220		
2511	G51170	F.1516	5115	12KHN2	14 220		
				18HG			
	G51200		5120	20KH	14 221		
			5120 H	20KH			
2216			A182-F11, A182-F12	12KHM	15 121		
2216			A387 Grade 12 Cl. 2				
2218	J21890	F.155	A182-F22	12KH8	15 313		
2085, 2090		F.144	9255	55S2			
2234	T51620	F.1250	4135	35KHM			
2710	T41901	F.5241	S1	5KHV2S			
	T61206		L6	5KHNV			
			5045				
			3135				
			3435				
	G98400		9840				
2541	G43400	F.1280	4340	38H2N2MA	16 343		
	G51320		5132	35KH			
	G51400		5140	40H	14 140		
2225	G41300	F.1251	4130	20KHM	15 130		
2244	G41400	F.1252	4142, 4140	38HM	15 142		
2240							
2230	H61500	F.143	6150	50KHFA	15 260		
2940	K24065	F.1740	A355 Cl. A				

SP

SL

PO

ST

ROLL

CARBIDE

LONG

HAND
TAPS

EG (STI)

SPECIAL
THREADS,
GAUGESTHREAD
MILLS

DIES

CENTER
DRILLSTechnical
info

Intro

SP

SL

PO

ST

ROLL

CARBIDE

LONG

HAND TAPS

EG (STI)

SPECIAL THREADS, GAUGES

THREAD MILLS

DIES

CENTER DRILLS

Technical info

Gr.	Materials	W.-Nr	DIN	EN-Nr.	EN	UNI	BS	JIS	AFNOR	
P4	High alloy steel Rm 800÷1000 N/mm ²	1.1231	Ck 67	1.1231	C 67S	C 70	060 A 67		XC 68	
		1.1274	Ck 101	1.1274	C 100S			060 A 96	SUP 4	
		1.1545	C 105 W1	1.1545	C 105U	C 100 KU			Y1 105	
		1.1645	C 105 W2			C 100 KU			SK 3	Y1 105
		1.1663	C 125 W			C 120 KU			SK 2	Y2 120
		1.2210	115 CrV 3	1.2210	107 CrV 3	107 CrV 3 KU				100 C 3
		1.2510	100 MnCrW 4			95 MnWCr 5 KU	B0 1	SKS 3		90 MWCV 5
		1.2842	90 MnCrV 8	1.2842	90 MnCrV 8	90 MnVCr 8 KU	B0 2			90 MV 8
		1.3505	100 Cr 6	1.3505	100 Cr 6	100 Cr 6	534 A 99	SUJ 2		100 C 6
P5	Tool steel Rm 900÷1200 N/mm ²	1.2080	X 210 Cr 12	1.2080	X 210 Cr 12	X 210 Cr 13 KU	BD 3	SKD 1	Z 200 C 12	
		1.2311	40 CrMnMo 7							
		1.2312	40 CrMnMoS 86							
		1.2343	X 38 CrMoV 5 1			X 37 CrMoV 5 1 KU	BH 11	SKD 6	Z 38 CDV 5	
		1.2344	X 40 CrMoV 5 1	1.2344	X 40 CrMoV 5 1	X 40 CrMo 5 1 1 KU	BH 13	SKD 61	Z 40 CDV 5	
		1.2363	X 100 CrMoV 5	1.2363	X 100 CrMoV 5 1	X 100 CrMoV 5 1 KU	BA 2	SKD 12	Z 100 CDV 5	
		1.2365	X 32 CrMoV 3 3			30 CrMoV 12 27 KU	BH 10	SKD 7	32 DCV 28	
		1.2379	X 155 CrVMo 12 1			X 155 CrMo 12 KU				
		1.2436	X 210 CrW 12			X 215 CrW 12 1 KU		SKD 2		
		1.2601	X 165 CrMoV 12			X 165 CrMoW 12 KU				
		1.2713	55 NiCrMoV 6					SKT 4	55 NCDV 7	
		1.2714	56 NiCrMoV 7			56 NiCrMoV 7 KU				
		1.3243	S 6-5-2-5	1.3243	HS 6-5-2-5	HS 6-5-2-5		SKH 55	Z 85 WDKCV 06-05-04-02	
		1.3247	S 2-10-1-8	1.3247	HS 2-10-1-8	HS 2-9-1-8	BM 42	SKH 51	Z 110 DKCVV 09-08-04	
		1.3255	S 18-1-2-5	1.3255	HS 18-1-2-5	HS 18-1-1-5	BT 4	SKH 3	Z 80 WKCV 18-05-04-01	
		1.3343	S 6-5-2	1.3343	HS 6-5-2	HS 6-5-2	BM 2	SKH 9, SKH 51	Z 85 WDCV 06-05-04-02	
1.3348	S 2-9-2	1.3348	HS 2-9-2	HS 2-9-2		SKH 58	Z 100 DCWV 09-04-02-02			
1.3355	S 18-0-1	1.3355	HS 18-0-1	HS 18-0-1	BT 1	SKH 2	Z 80 WCW 18-04-01			
P6	High tensile strength steel Rm 1200÷1480 N/mm ² HRC 38÷45	1.6546	40 NiCrMo 2 2	1.6546	40 NiCrMo 2 KD	40NiCrMo2	311 - Type 7	SNCM 240	40 NCD 2	
		1.7045	42 Cr 4	1.7045		41Cr4	530 A 40	SCR 440	42 C 4 TS	
P7	Ferritic - Martensitic stainless steel	1.4000	X 6 Cr 13	1.4000	X 6 Cr 13	X 6 Cr 13	403 S 17	SUS 403	Z 6 C 12	
		1.4006	X 10 Cr 13	1.4006	X 12 Cr 13	X 12 Cr 13	410 S 21	SUS 410	Z 10 C 13	
		1.4016	X 6 Cr 17	1.4016	X 6 Cr 17	X 8 Cr 17	430 S 15	SUS 430	Z 8 C 17	
		1.4021	X 20 Cr 13	1.4021	X 20 Cr 13	X 20 Cr 13	420 S 37	SUS 420 J 1	Z 20 C 13	
		1.4031	X 40 Cr 13	1.4031	X 39 Cr 13	X 40 Cr 14	420 S 45	SUS 420	Z 40 C 14	
		1.4109	X 65 CrMo 14	1.4109	X 70 CrMo 15			SUS 440 A	Z 70 D 14	
		1.4112	X 90 CrMoV 18	1.4112	X 90 CrMoV 18	X CrTi 12	409 S 19	SUS 440 B	Z 2 CND 18 05	
		1.4125	X 105 CrMo 17	1.4125	X 105 CrMo 17	X 105 CrMo 17		SUS 440 C	Z 100 CD 17	
		1.4313	X 5 CrNi 13 4	1.4313	X 5 CrNiMo 13 3	X 6 CrNi 13 04	425 C 11	SCS 5	Z 5 CN 13.4	
1.4749	X 18 CrN 28	1.4749	X 18 CrN 28				Z 18 C 25			
P8	PH stainless steel	1.4534	X 3 CrNiMoAl 13 8 2	1.4534	X 6 NiCrTiMoV 25 15					
		1.4540	X 4 CrNiCuNb 16 4	1.4540	X 4 CrNiCuNb 16 4	Z 4 CNUNb 16.4 M			Z 4 CNUNb 16.4 M	
		1.4548	X 5 CrNiCuNb 17 4	1.4548	X 5 CrNiCuNb 17 4	Z 6 CNU 17.4		SCS 24, SUS 630		
		1.4568	X 7 CrNiAl 17 7	1.4564	X 3 CrNiMoAl 13 8 2	X 7 CrNiAl 17 7	301 S 81	SUS 631	Z 9 CAN 17.7	
		1.6356	X 2 NiCoMoTi 18 12 4	1.6356	X 2 NiCoMoTi 18 12 4					

Intro

SS	UNS	U.N.E. / I.H.A.	AISI-ASTM	GOST	ČSN	Trade Mark	Structure
1770	G10700	F.5103	1070	70			
1870	G10950	F.5117	1095				
1880		F.5118	W1	U10A			
				U10			
			W1	U13			
	T61202	F.520L	L2	11KHF			
2140	T31501	F.5220	01	9KHWG			
	T31502		02	9G2F		K720	
2258	G51986	F.5230	52100	SHKH15	14 109		
						TOOLOX 33	
	T30403	F.5212	D3	KH12		K100	
						M201	
						M200 - HOLDAX	
	T20811		H11	4KH5MFS		VIDAR - W300	
2242	T20813	F.5318	H13	4KH5MF15		ORVAR - W302	
2260	T30102	F.5227	A2	9KH5VF			
	T20810		H10	3KH3M3F		W320	
						K110	
2312		F.5213		KH12			
2310				KH12MF			
	T61206	F.520.S	L6	5KHNM			
			L6			W500	
2723		F.5613	M35	R6M5K5			
	T11342		M42	R2AM9K5			
	T12004		T4	R18K5F2			
2722	T11302	F.5603	M2	R6M5		S600	
2782	T11307		M7				
	T12001		T1	R18			
	G86400		8640			Monix	
2245			5140				
						HARDOX 400®	
						HARDOX 450®	
						TOOLOX 40®	
						TOOLOX 44®	
2301	S41008		403	08KH13			Ferritic
2302	S41000	F.3401	410, CA-15	12KH13			Martensitic
2320	S43000	F.3113	430	12KH17			Ferritic
2303	S42000	F.5261	420	20KH13	17 022		Martensitic
2304	S40280	F.3404	420 C	40KH13			Martensitic
	S44002		440 A				Martensitic
2327	S44003		440 B	95KH18			Martensitic
	S44004		440 C	95KH18			Martensitic
2385	S41500		A182 F6NM				Martensitic
2322	S44600		446	15KH28			Ferritic
	S13800		XM-13			PH13-8 Mo	Austenitic
	S15500		XM-12			15-5-PH	Martensitic
	S17400		630			17-4-PH	Martensitic
2388	S17700		631	09KH17N7YU1		17-7-PH	Austenitic/Ferritic
	K93160		AMS 6515				Martensitic

SP

SL

PO

ST

ROLL

CARBIDE

LONG

HAND
TAPS

EG (STI)

SPECIAL
THREADS,
GAUGESTHREAD
MILLS

DIES

CENTER
DRILLSTechnical
info

Intro

SP

SL

PO

ST

ROLL

CARBIDE

LONG

HAND TAPS

EG (STI)

SPECIAL THREADS, GAUGES

THREAD MILLS

DIES

CENTER DRILLS

Gr.	Materials	W.-Nr	DIN	EN-Nr.	EN	UNI	BS	JIS	AFNOR
M1	Austenitic stainless steel (good machinability)	1.4300	X 12 CrNi 18 8	1.4300	X 12 CrNi 18 8		302 S 25	SUS 302	Z 12 CN 18
		1.4301	X 5 CrNi 18 10	1.4301	X 5 CrNi 18 10	X 5 CrNi 18 11	304 S 31	SUS 304	Z 6 CN 18.09
		1.4305	X 10 CrNiS 18 9	1.4305	X 10 CrNiS 18 9	X 10 CrNi 18 09	303 S 31	SUS 303	Z 10 CNF 18.09
		1.4306	X 2 CrNi 19 11	1.4306	X 2 CrNi 19 11	X 3 Cr Ni 18 11	304 S 12	SUS 304 L	Z 2 CN 18.10
		1.4310	X 12 CrNi 17 7	1.4310	X 9 CrNi 18 8	X 12 CrNi 17 07	301 S 21	SUS 301	Z 12 CN 17.07
		1.4550	X 6 CrNiNb 18 10	1.4550	X 6 CrNiNb 18 10	X 6 CrNiNb 18 11	347 S 31	SUS 347	Z 6 CNNb 18.10
M2	Austenitic stainless steel (medium machinability) and Duplex	1.4311	X 2 CrNiN 19 11	1.4311	X 2 CrNiN 18 10	X 2 CrNiN 18 11	304 S 62	SUS 304 LN	Z 2 CN 18 .10 Az
		1.4335	X 12 CrNi 25 21	1.4335	X 12 CrNi 25 21	X 6 CrNi 26 20	310 S 24	SUH 310, SUS 310 S	Z 12 CN 25.20
		1.4401	X 5 CrNiMo 17 12 2	1.4401	X 5 CrNiMo 17 12 2	X 5 CrNiMo 17 12	316 S 31	SUS 316	Z 3 CND 17.11.1
		1.4417	X 2 CrNiMoSi 19 5	1.4424	X 2 CrNiMoSi 19 5				Z 2 CND 18.05.03
		1.4429	X 2 CrNiMoN 17 13 3	1.4429	X 2 CrNiMoN 17 13 3	X 2 CrNiMoN 17 13 3	316 S 62	SUS 316 LN	Z 2 CND 17.13 Az
		1.4435	X 2 CrNiMo 18 14 3	1.4435	X 2 CrNiMo 18 14 3	X 2 CrNiMo 17 13 2	316 S 12	SCS 16, SUS 316 L	Z 2 CND 17.13
		1.4438	X 2 CrNiMo 18 16			X 2 CrNiMo 18 16	317 S 12	SUS 317 L	Z 2 CND 19.15
		1.4460	X 4 CrNiMo 27 5 2	1.4460	X 3 CrNiMo 27 5 2	X 3 CrNiMo 27 5 2		SUS 329 J 1	Z 3 CND 25.7 Az
		1.4462	X 2 CrNiMoN 22 5	1.4462	X 2 CrNiMoN 22 5 3	X 2 CrNiMoN 22 5	332 S 15		Z 2 CND 22.05 Az
		1.4466	X 5 CrNi 18 15	1.4466	X 3 CrNiMo 18 12 3	X 5 CrNi 18 15	317 S 16	SUS 317	
		1.4541	X 10 CrNiTi 18 9	1.4541		X 6 CrNiTi 18 11	321 S 12	SUS 321	Z 6 CND 18.10
		1.4550	X 6 CrNiNb 18 10	1.4550	X 6 CrNiNb 18 10	X 6 CrNiNb 18 11	347 S 31	SUS 347	Z 6 CNNb 18.10
		1.4571	X 10 CrNiMoTi 18 10			X 6 CrNiMoTi 17 12	320 S 17	-	Z 6 CNDT 17.12
		1.4893	X 9 CrNiSiN 21 11 2	1.4835	X 9 CrNiSiN 21 11 2		310 S 31		
M3	Super austenitic stainless steel and super Duplex	1.4410	X 2 CrNiMoN 25 7 4	1.4410	X 2 CrNiMoN 25 7 4	X 2 CrNiMoN 25 7 4			Z 3 CND 25.07 Az
		1.4501	X 2 CrNiMoCuWN 15 7 4			X 2 CrNiMoCuWN 15 7 4			
		1.4529	X 1 CrNiMoN 20 18 7	1.4547	X 1 CrNiMoN 20 18 7	X 1 CrNiMoN 20 18 7			Z 1 CNDU 20.18.05 Az
		1.4539	X 2 NiCrMoCu 25 20 5	1.4539	X 2 NiCrMoCu 25 20 5		904 S 13		Z 2 NCDU 25 20
		1.4652	X 2 CrNiMoN 25 22 7	1.4652	X 1 CrNiMoN 25 22 8				
		1.4876	X 10 NiCrAlTi 32 20	1.4876	X 10 NiCrAlTi 32 20			NCF 800	Z 10 NC 32.21
		1.4943	X 4 NiCrTi 25 15	1.4980	X 5 CrNiCuNb 16 4		HR 51	SUH 660	Z 6 NCTDV 25.15
K1	Grey cast iron 150 ÷ 250 HB	0.6015	GG-15	5.1200	EN-GJL-150	G15	Grade 150	FC 150	Ft 15 D
		0.6020	GG-20	5.1300	EN-GJL-200	G20	Grade 220	FC 200	Ft 20 D
		0.6025	GG-25	5.1301	EN-GJL-250	G25	Grade 260	FC 250	Ft 25 D
		0.6027	GG-220 HB		EN-GJL-215				
		0.6035	GG-35	5.1303	EN-GJL-350	G35	Grade 350	FC 350	Ft 35 D
K2	Nodular cast iron 150 ÷ 350 HB	0.7033	GGG 35.3	5.3100	EN-GJS-350-22		Grade 350/22	FCD 350-22L	FGS 370-17
		0.7040	GGG 40	5.3106	EN-GJS-400-15	GS400-12	Grade 420/12		FGS 400-12
		0.7043	GGG 40.3	5.3105	EN-GJS-400-18	GSO 42/17	Grade 370/17	FCD 400-18L	FGS 370-17
		0.7050	GGG 50	5.3200	EN-GJS-500-7	GSS500-7	Grade 500/7	FCD 500-7	FGS 500-7
		0.7060	GGG 60	5.3201	EN-GJS-600-3	GS600-3	Grade 600/3	FCD 600-3	FGS 600-3
		0.7070	GGG 70	5.3300	EN-GJS-700-2	GS700-2	Grade 700/2	FCD 700-2	FGS 700-2
		0.8155	GTS-55-04		EN-GJMB-550-4	P 55-04	P 540/5	PCMP55-04	P 540/5
		0.9990	GGV-40	5.2201	EN-GJV-400				
			GGV-45	5.2300	EN-GJV-450				
	GGV-50	5.2301	EN-GJV-500						
K3	ADI cast iron 250 ÷ 500 HB		GJS-800-8	5.3301	EN-GJS-800-8				
			GJS-1000-5		EN-GJS-1000-5				
			GJS-1200-2		EN-GJS-1200-2				
			GJS-1400-1	5.3405	EN-GJS-1400-1				
K4	Austenitic cast iron 120 ÷ 260 HB	0.6655	GGL-NiCuCr 15 6 2		EN-GJLA-XNiCuCr 15-6-2		Grade F1		FGL Ni15 Cu6 Cr2
		0.6660	GGL-NiCr 20 2		EN-GJLA-XNiCr 20-2		Grade F2		FGL Ni20 Cr2
		0.6676	GGL-NiCr 30 3		EN-GJLA-XNiCr 30-3		Grade F3		FGL Ni30 Cr3
		0.7652	GGG-NiMn 13 7		EN-GJSA-XNiMn 13-7		Grade S6		FGS Ni13 Mn7
		0.7660	GGG-NiCr 20 2	5.3500	EN-GJSA-XNiCr 20-2		Grade S2		FGS Ni20 Cr2
		0.7673	GGG-NiMn 23 4		EN-GJSA-XNiMn 23-4		Grade S2M		FGS Ni23 Mn4
		0.7676	GGG-NiCr 30 3	5.3507	EN-GJSA-XNiCr 30-3		Grade S3		FGS Ni30 Cr3
		0.7683	GGG-Ni 35	5.3504	EN-GJSA-XNi 35				FGS Ni35

Technical info

SS	UNS	U.N.E. / I.H.A.	AISI-ASTM	GOST	ČSN	Trade Mark	Structure
2331	S30200		302	12KH18N9			Austenitic
2333	S30400	F.3504	304	08KH18N10	17 240		Austenitic
2346	S30300	F.3508	303	12KH19N9			Austenitic
2352	S30403	F.3504	304 L	03KH18N11			Austenitic
	S30100	F.3517	301	07KH16N6			Austenitic
2338	S34700		347	08KH18N12B			Austenitic
2371	S30453	F.3541	304 LN	03KH18N11			Austenitic
2361	S31008		310 S	12KH25N20			Austenitic
2347	S31600	F.3534	316	08KH17H13M2T	17 346		Austenitic
2376	S31500						Duplex
2375	S31653		316 LN	03KH16N15M3			Austenitic
2353	S31603	F.3533	316 L	03KH17N14M3	17 349		Austenitic
2367			317 L				Austenitic
2324	S32900		329				Duplex
2377	S31803		329 LN				Duplex
2366	S31700		317	08KH17H15M3T			Austenitic
2337			321				Austenitic
2338	S34700	F.3524	347	08KH18N12B			Austenitic
2350			316 Ti				Austenitic
2368	S30815						Austenitic
2328	S32750		F 53				Super duplex
	S32760		F 55-329 S				Super duplex
2778	S31254						Super Austenitic
2562	N08904		904L				Super Austenitic
	S32654						Super Austenitic
	N08800					Alloy 800	Austenitic
2570	S66286		660			A286	Austenitic
01 15-00	F11601		A48 25 B	Sc 15	422 415		Lamellar
01 20-00	F12101		A48 30 B	Sc 20	422 420		Lamellar
01 25-00	F12401		A48 35 B	Sc 25	422 425		Lamellar
02 19							Lamellar
01 35-00	F13502		A48 50 B	Sc 35			Lamellar
07 17-15					422 303		Nodular
07 17-02		FGE 38-17		Vc 42-12	422 304		Nodular
07 17-12	F32800		60-40-18	Vc 42-12	422 314		Nodular
07 27-02	F33800	FGE 50-7	A536, 80-55-06	Vc 50-2	422 305		Nodular
07 32-03	F34100	FGE 60-2	A476, 80-60-03	Vc 60-2	422 306		Nodular
07 37-01	F34800	FGE 70-2	A536, 100-70-03	Vc 70-2	422 307		Nodular
08 54-00	F24130		A220 60004				Malleable
			Grade 400-15				Vermicular
			Grade 450				Vermicular
			Grade 500				Vermicular
	ADI grade 1		850/550/10			ADI 800	Ductile austempered
	ADI grade 2		1050/700/7			ADI 1000	Ductile austempered
	ADI grade 3		1200/850/4			ADI 1200	Ductile austempered
	ADI grade 4		1400/1100/1			ADI 1400	Ductile austempered
	F41000		A436 Type 1			Ni-Resist 1	Lamellar
05 23-00	F41002		A436 Type 2			Ni-Resist 2	Lamellar
	F41004		A436 Type 3			Ni-Resist 3	Lamellar
07 72-00						Nodumag	Nodular
	F43000		A436 Type D-2			Ni-Resist D-2	Nodular
	F43010		A439 Type D-2M			Ni-Resist D-2M	Nodular
	F43003		A436 Type D-3			Ni-Resist D-3	Nodular
	F43006		A439 Type D-5			Ni-Resist D-5	Nodular

SP

SL

PO

ST

ROLL

CARBIDE

LONG

HAND
TAPS

EG (STI)

SPECIAL
THREADS,
GAUGESTHREAD
MILLS

DIES

CENTER
DRILLSTechnical
info

Intro

Gr.	Materials	W.-Nr	DIN	EN-Nr.	EN	UNI	BS	JIS	AFNOR	
SP	N1 Aluminium alloy < 12% Si	3.0205	Al 99			9001/1	1C	A1x3	A4	
		3.0255	Al99.5	Al99.5	AW-1050A	9001/2	1B	(A1050)	A-5/1050A	
		3.0505	AlMn0,5Mg0,5				N31			
SL		3.0517	AlMn1Cu	AlMn1Cu	AW-3003			A3003	A-M1/3003	
		3.0615	AlMgSiPb						ASGPB	
		3.1255	AlCuSiMn	AlCuSiMn	AW-2014			H15	A-U45G	
		3.1305	AlCuMg0,5			9002/1	L86		AU2G	
		3.1325	AlCuMg 1			9002/2	(H14)	A3x2	AU4G	
PO		3.1355	AlCuMg 2			9002/4	DTD5090	A3x4	AU4G1	
		3.1645	AlCuMgPb			9002/8	-	-	AU4Pb	
		3.1655	AlCuBiPb	AlCuBiPb	AW-2011		FC1	A2011	A-USPbBi	
ST		3.2161	G-AlSi8Cu3	AlSi8Cu3(Si)	AC-46200					
		3.2315	AlSi1MgMn	AlMgSi1	AW-6082	90006/4	H30		A-SGM0.7	
		3.2341	G-AlSi5Mg		AC-42000	3599	LM25	AC 4C	A-57G	
		3.2381	G-AlSi10Mg	AlSi10Mg(Fe)	AC-43400		LM9		A-510G	
		3.2383	G-AlSi10Mg (Cu)		43200		(LM9)		A-510UG	
ROLL		33.206	AlMgSi0.5	AlMgSi0.5	AW-6060			(H9)	A-GS/6060	
		3.3210	AlMgSi0.7	AlMgSi0.7	AW-6063			(H10)	(A6063)	A-GSUC/6061
		3.3211	AlMg1SiCu			9006/2	H20	A2x4	AGSUC	
		3.3315	AlMg1	AlMg1	AW-5005			N41	A-G0.6	
		3.3316	AlMg1,5			9005/7				
CARBIDE		3.3523	AlMg2,5			9005/2		A2x1	AG2,5C	
		3.3535	AlMg3			9005/8	N5/N56		AG3	
		3.3547	AlMg4.5Mn0.7			9005/5	N8	A2x7	AG4,5MC	
		3.3555	AlMg5				N6		A-G5	
		3.4335	AlZn4.5Mg1	AlZn4.5Mg1	AW-7020			H17	A-Z5G	
LONG		34.365	AlZn5.5MgCu		AW-7075	9007/2	2L95	A7075	A-Z5GU	
		3.5612	G-MgAl6Zn	MgAl6Zn	MG-P-63			MAG-E-121	G-A6-Z1	
		3.5812	G-MgAl8Zn	MgAl8Zn	MG-P-61				(G-A7-Z1)	
		HAND TAPS	32.382	G-AlSi12	AlSi12	AC-44200	4514	LM6	AC3A	AS 13
	3.2583		G-AlSi12 (Cu)	AlSi12 (Cu)	AC-47000		LM20	Al-Si12Cu		
3.5101	G-MgZn4SE1Zr1						MAG5	G-Z4TR		
3.5102	G-MgZn5Th2Zr1									
35.103	G-MgSe3Zn2Zr1		MgSe3Zn2Zr1	MN65120			MAG6-TE	ZRE1		
EG (STI)	3.5106	G-MgAg3SE2Zr1					MAG 12	G-Ag22,5		
	3.5312	G-MgAl3Zn					MAG-E-111			
	3.5912	G-MgAl9Zn1					MAG7	G-A9Z1		
SPECIAL THREADS, GAUGES	N3 Copper alloy	2.0040	OF Cu		CW008A		C103	C1020	Cu/c1	
		2.0060	E-Cu57		CW004A	E-Cu57	C101	C1100	Cu/a1	
		2.0070	SE Cu		CW021A					
		2.0090	SF Cu		CW024A		C106	C1220	Cu/b	
		2.0240	CuZn15	CuZn15	CW502L		CZ102	C2300	CuZn15	
		2.0321	CuZn37		CW508L		CZ108		CuZn37	
		2.0401	CuZn39Pb3	CuZn39Pb3	CW614N		CZ121		CuZn39Pb3	
		2.0402	CuZn40Pb2	CuZn40Pb2	CW612N		CZ120		CuZn39Pb2	
		20.530	CuZn38Sn1	CuZn38Sn1	CW717R					
		2.0790	CuNi18Zn19Pb	CW408J					CuNi18Zn19Pb1	
		2.0872	CuNi10Fe1Mn	CuNi10Fe1Mn			CN102		CuNi10Fe1Mn	
		2.0940	CuAl10Fe		CC331G		AB1		CuAl10Fe	
		2.0975	CuAl10Ni		CC333G		AB2		CuAl10Ni5Fe5	
		2.1050	CuSn10		CC480K		CT1		CuSn10	
		2.1087	CuSn10Zn							
2.1176	CuPb10Sn		CW352H		LB2		CuSn10Pb10			
2.1202	SB Cu				C107					

CENTER DRILLS

Technical info

Intro

SS	UNS	U.N.E. / I.H.A.	AISI-ASTM	GOST	ČSN	Trade Mark	Structure
4010			A1200				
4007	AA1050A		A1050/1050A				
			3105				
	AA3003					Aluman 100	
			6012				
4338	AA2014		2014			Avional 660	
			2117			Avional 050	
			2017			Avional 100	
			2024			Avional 150	
4335			2030				
4355	AA2011		2011			Recidal 11	
4251	A13800		A380				
4212	A96082		6082			Anticorodal 100	
4244			B26				
4253	A13600		B85				
4103	AA6060					Anticorodal 063	
4104, 4107	AA6005						
			6061			Anticorodal 061	
4106	AA5005					Peraluman 080	
			5050			Peraluman 150	
4120			5052			Peraluman 250	
			5154			Peraluman 350	
4140	A95083		5083			Peraluman 440	
			5056			Peraluman 500	
4425	AA7020		7020				
	A97075		7075	B95		Ergal	
	M11600		AZ61A				
			AZ80A				
			A413.2				
	M12330		AMS 4442				
			AZ31B				
	C10200						
	C11000						
	C10300						
	C12200						
5112	C23000			L90			
5150	C27200						
5170	C38500						
5168	C37800						
	C46400				L060-1		
	C76300						
5667	C70600						
5710	C95200		CA952	BrA9ZH3L			
5716	C95500		CA955	BrA10ZH4N4L			
5443	C90700						
5458	C90500						
5640	C93700		CA937				
	C14200						

SP

SL

PO

ST

ROLL

CARBIDE

LONG

HAND
TAPS

EG (STI)

SPECIAL
THREADS,
GAUGESTHREAD
MILLS

DIES

CENTER
DRILLSTechnical
info

Intro

Gr.	Materials	W.-Nr	DIN	EN-Nr.	EN	UNI	BS	JIS	AFNOR	
SP	N4 Brass alloy and Bronze alloy	2.0220	CuZn5		CW500L		CZ125	C2100		
		2.0230	CuZn10		CW501L		CZ101	C2200		
		2.0250	CuZn20		CW503L		CZ103	C2400		
		2.0265	CuZn30		CW505L		CZ106	C2600		
		2.0331	CuZn36Pb1.5		CW600N		CZ119	C3501		
		2.0360	CuZn40		CW509L		CZ109	C2800		
		2.0372	CuZn39Pb0.5		CW610N		CZ123			
		2.0375	CuZn36Pb3		CW603N		CZ124	C3601		
		2.0380	CuZn39Pb2		CW612N		CZ 131	C3771		
		2.0401	CuZn39Pb3	12164	CW614N	5705	CZ121	C3603		
		2.0402	CuZn40Pb2		CW617N		CZ122			
		2.0410	CuZn44Pb2	CuZn44Pb2	CW622N		CZ104			
		2.0460	CuZn20Al2				CZ110			
		2.0470	CuZn28Sn1	CuZn28Sn1	CW706R				CuZn29Sn1	
		2.0932	CuAl8Fe3		CW303G					
2.0966	CuAl10Ni5Fe4		CW307G			CA104				
2.1010	CuSn2					-	-			
2.1016	CuSn4					PB101	C5111			
21.020	CuSn6	CuSn6	CW452K			PB103	C5191	CuSn6		
2.1030	CUSn8					PB104	C5212			
N5	Plastic material									
CARBIDE	N6 Carbon fiber and composite									
HAND TAPS	S1 Heat resistant super alloy (HRSA) Ni base (good machinability) < 25 HRC	1.4980							Z3NCT25	
		2.4617							NiMo28	
			NiCr17Mo17FeW							NC17DWY
		2.4816	NiCr15Fe							NC15Fe
		2.4851	NiCr23Fe							NC15FeA
		2.4856	NiCr22Mo9Nb							NC22DNb
		2.4669	NiCr 15 Fe 7 TiAl					HR505		NC19FeNB
SPECIAL THREADS, GAUGES	S2 Heat resistant super alloy (HRSA) Ni base (medium machinability) 25 ÷ 35 HRC	1.4876	X10NiCrAlTi32-21				3075			
		2.4858	NiCr21Mo						NC21FeDU	
		2.4665	NiCr22FeMo				HR6,204		NC22FeD	
		2.4856	NiCr22Mo9Nb						NC22DNb	
		2.4856	NiCr22Mo9Nb						NC22DNb	
		2.4668	NiCr19Fe19NbMo				HR8		NC19FeNb	
		2.4668	NiCr19Fe19NbMo				HR8		NC19FeNb	
		2.4630	NiCr20Ti				HR5,203-4		NC20T	
		2.4631	NiCr20TiAl				HR401,601		NC20TA	
		2.4654	NiCr20Co14MoTi						NC20K14	
DIES	S3 Heat resistant super alloy (HRSA) Ni base (low machinability) 35 ÷ 45 HRC	2.4654	NiCr20Co14MoTi						NC20K14	
		2.4668	NiCr19Fe19NbMo				HR8		NC19FeNb	
		2.4669	NiCr 15 Fe 7 TiAl				HR505		NC19FeNB	
			NiW13Co10Cr9AlTi							
			NiCo10W10Cr9AlTi							
			NiCr18cCoMoAlTi						NCK19DAT	
CENTER DRILLS	S3 Heat resistant super alloy (HRSA) Ni base (low machinability) 35 ÷ 45 HRC								NCKD20AT	
			NiCo15Cr15MoAlTi						NCKD20AT	

Technical info

Intro

SS	UNS	U.N.E. / I.H.A.	AISI-ASTM	GOST	ČSN	Trade Mark	Structure
	C21000						
	C22000						
	C24000						
	C26000						
	C34000						
	C28000						
	C36500						
	C36000						
	C37700						
	C38500					OT-58	
	C38000						
5272	C68700			LAMsh77-2-0.05			
	C68700						
5220	C44300			LOMsh70-1-0.05			
	C61400						
	C63000						
	C50700						
	C51100						
5428	C51900			BrOF6.5-0.15			
	C52100						
							Polycarbonate
							E-glass
							Epoxy
							HTA
							HX
							Kevlar
							PEEK
							PPS
							T300
							T700
							T800
			5725			Disicalloy	HRSA Iron-based
	N10665					Hastelloy B-2	HRSA Nickel-based
	N10002					Hastelloy C (casting)	HRSA Nickel-based
	N06600					Inconel 600	HRSA Nickel-based
	N06601					Inconel 601	HRSA Nickel-based
	N06625					Inconel 625 (casting)	HRSA Nickel-based
						Inconel 706	HRSA Nickel-based
	N07750					Inconel X750 (solubilized)	HRSA Nickel-based
						Stellite	HRSA Cobalt-based
	N08800					Incoloy 800	HRSA Iron-based
	N08825					Incoloy 825	HRSA Iron-based
	N06002					Hastelloy X	HRSA Nickel-based
	N06625					Inconel 625 (forged)	HRSA Nickel-based
	N06625					Inconel 625 (pipe)	HRSA Nickel-based
	N07718					Inconel 718 (casting)	HRSA Nickel-based
	N07718					Inconel 718 (pipe)	HRSA Nickel-based
	N06075					Nimonic 80	HRSA Nickel-based
	N07080					Nimonic 81	HRSA Nickel-based
	N07001					Waspalloy (casting)	HRSA Nickel-based
						Haynes	HRSA Cobalt-based
	N07001					Waspalloy (forged)	HRSA Nickel-based
	N07718					Inconel 718 (forged)	HRSA Nickel-based
	N07750					Inconel X750 (precipitation)	HRSA Nickel-based
						Mar-M 200	HRSA Nickel-based
						Mar-M 247	HRSA Nickel-based
						Rene 95	HRSA Nickel-based
						Udimet 500	HRSA Nickel-based
						Udimet 700	HRSA Nickel-based

SP

SL

PO

ST

ROLL

CARBIDE

LONG

HAND TAPS

EG (STI)

SPECIAL THREADS, GAUGES

THREAD MILLS

DIES

CENTER DRILLS

Technical info

Intro

SP

SL

PO

ST

ROLL

CARBIDE

LONG

HAND
TAPS

EG (STI)

SPECIAL
THREADS,
GAUGES

THREAD
MILLS

DIES

CENTER
DRILLS

Technical
info

Gr.	Materials	W.-Nr	DIN	EN-Nr.	EN	UNI	BS	JIS	AFNOR
S4	Titanium alloy good machinability		TiAl2Sn4Zr2MoSi						
			TiAl2Sn4Zr6Mo						
		3.7055	Ti 99,6						
		3.7195	Ti3Al2.5V						
		3.7115	TiAl5Sn2.5				TA14/17		
		3.7124	TiCu2,5						
		3.7155	TiAl6Zr5Mo0,5						
		3.7165	TiAl6V4 ELI				TA11		
		3.7175	TiAl6V6Sn2						
		3.7185	TiAl4Mo4Sn2						
3.7025	Ti 99,8					TA 1			
3.7035	Ti 99,7a					TA 2-5			
S5	Titanium alloy medium machinability	3.7164	TiAl6V4						
			Ti5Al2.5Sn						
			TiAl2Sn4Zr2MoSi						
			TiAl2Sn4Zr6Mo						
H1	Hardened steel 45 ÷ 55 HRC	1.1231	Ck 67	1.1231	C 67S	C 70	060 A 67		XC 68
		1.1248	Ck 75	1.1248	C 75S	C 75	060 A 78		XC 75
		1.1274	Ck 101	1.1274	C 100S		060 A 96	SUP 4	
		1.1545	C 105 W1	1.1545	C 105U	C 100 KU			Y1 105
		1.2550	60 WCrV 7			55 WCrV 8 KU			55 WC 20
		1.7131	16 MnCr 5	1.7131	16 MnCr 5	16 MnCr 5	527 M 17	SCR 415	16 MC 5
		1.7176	55 Cr 3	1.7176	55 Cr 3	55 Cr 3	527 A 60	SUP 9 (A)	55 C 3
		2.4669	NiCr 15 Fe 7 TiAl				HR505		NC19FeNB
H2	Hardened steel 55 ÷ 63 HRC	1.2210	115 CrV 3	1.2210	107 CrV 3	107 CrV 3 KU			100 C 3
		1.2510	100 MnCrW 4			95 MnWCr 5 KU	B0 1	SKS 3	90 MWCV 5
		1.2842	90 MnCrV 8	1.2842	90 MnCrV 8	90 MnVCr 8 KU	B0 2		90 MV 8
		1.3505	100 Cr 6	1.3505	100 Cr 6	100 Cr 6	534 A 99	SUJ 2	100 C 6

Intro

SS	UNS	U.N.E. / I.H.A.	AISI-ASTM	GOST	ČSN	Trade Mark	Structure
	R50250		265-G1			Grade 1	
	R50400		265-G2			Grade 2	
	R50550		265-G3			Grade 3	
	R56320					Grade 9	
	R50700		265-G4			Grade 4	
	R56400					Grade 5	
						Grade 6	
			4975			6242	
	R56260					6246	
1770	G10700	F.5103	1070	70			
1774, 1778	G10780	F.5107	1078, 1080	75			
1870	G10950	F.5117	1095				
1880		F.5118	W1	U10A			
			S1	5KHV2SF			
2511	G51170	F.1516	5115	12KHN2	14 220		
2253	G51550		5155				
	N07750					Inconel X750 (solubilized)	HRSA Nickel-based
	T61202	F.520L	L2	11KHF			
2140	T31501	F.5220	01	9KHVG			
	T31502		02	9G2F			
2258	G51986	F.5230	52100	SHKH15	14 109		

SP

SL

PO

ST

ROLL

CARBIDE

LONG

HAND TAPS

EG (STI)

SPECIAL THREADS, GAUGES

THREAD MILLS

DIES

CENTER DRILLS

Technical info

COMPANY INFORMATION



Company History

- November 1923:** Founded by Jokichi Watanabe in Shibuya-ku, Tokyo.
- December 1937:** Company incorporated.
- May 1945:** Factory established in Yonezawa City in Yamagata prefecture.
- January 1953:** Spun off Yonezawa Factory into a separate company as YAMAWA TAP Co.,Ltd.
- June 1955:** All products certified to Japanese Industrial Standard (JIS) categories.
- October 1956:** Awarded by the Department of Trade and Industry for superiority in industrial standardization.
- October 1963:** Awarded by the Institute of Industrial Technology for superiority in industrial standardization.
- April 1964:** Newly constructed Fukushima Factory began operation.
- November 1973:** Awarded from the Department of Trade and Industry as superiority in industrial standardization.
- October 1983:** Established YAMAWA ENGINEERING Co., Ltd.
- December 1984:** New machine tool manufacturing shop constructed inside the Fukushima Factory.
- October 1986:** Newly completed Aizu Factory began operation.
- July 1989:** Newly constructed Taiwan Factory opened.
- April 1991:** Spun off Fukushima Factory and Aizu Factory into a separate company, YAMAWA PRECISION Co., Ltd.
- November 1995:** Established TC (Total Cutting) CENTER Co., Ltd.
- June 1996:** YAMAWA TAP Co., Ltd. obtained ISO 9001 certification.
- July 2000:** YAMAWA PRECISION Co., Ltd. in Aizu Factory obtained ISO 9001 certification.
- October 2000:** YAMAWA PRECISION Co., Ltd. in Fukushima Factory also obtained ISO 9001 certification.
- August 2001:** Established YAMAWA TC CENTER Co., Ltd from TC CENTER.
- October 2002:** Obtained ISO14001 certification in YAMAWA PRECISION Co., Ltd. at Fukushima Factory.
- December 2002:** Obtained ISO14001 certification in YAMAWA PRECISION Co., Ltd. at Aizu Factory.
- January 2003:** Obtained ISO14001 certification in YAMAWA TAP Co.,Ltd.
- October 2003:** Obtained ISO14001 certification in YAMAWA Mfg. Co.,Ltd.
- April 2006:** Obtained ISO14001 certification in TAIWAN YAMAWA Co.,Ltd.
- October 2006:** Spun off Export Dept. into a separate company, YAMAWA INTERNATIONAL Co., Ltd.
- January 2007:** Spun off Taiwan Sales Dept into a separate company, YAMAWA ASIA Co., Ltd.
- May 2007:** Obtained ISO14001 certification in YAMAWA ASIA Co.,Ltd.
- March 2008:** Newly constructed Tsutsumi Factory of Yamawa Mfg began operation.
- September 2008:** Obtained ISO14001 certification in YAMAWA ENGINEERING Co.,Ltd., YAMAWA TC CENTER Co.,Ltd and YAMAWA INTERNATIONAL Co.,Ltd.
- June 2011:** Obtained ISO14001 and ISO9001 certification in YAMAWA Tsutsumi Factory.
- February 2012:** Obtained ISO9001 certification in TAIWAN YAMAWA and YAMAWA ASIA.
- October 2012:** Obtained ISO9001 certification in YAMAWA Mfg. Co., Ltd.
- December 2013:** Newly constructed Tsutsumi No.2 Factory of Yamawa Mfg. began operation.
- October 2014:** YAMAWA TC Center Co., LTD. and YAMAWA Engineering Co., LTD. were merged into a new company "YAMAWA Engineering Service Co., LTD."
- January 2016:** YAMAWA Europe S.p.A. founded in Italy.

ISO 9001/14001 certification



Origin of corporate name, "YA" "MA" "WA".

Y Mr. Jokichi Watanabe, the founder of the company, decided to use shop name "YA" "MA" "WA", which he had been using in his family business instead of using his personal name. And he gave to his company the name "YA" "MA" "WA" by employing lucky words and the same connotation "YAMAWA" from ancient Japanese characters, MANYOGANA. The meaning of YAMAWA is "Greater prosperity, More united". In this word, he put a wish "as the company becomes prosperous, the harmony among employees becomes more precious".

Yamawa factories in Japan



The Tsutsumi plant is the main tool blank manufacturing operation of Yamawa group. This location is also the testing center where Yamawa executes the innovation in metal machining and performance tests of the products for the Yamawa group.



Yonezawa is the main manufacturing plant of the Yamawa Group, this location is equipped with production lines and is the Quality Control Center. The plant obtained ISO 9001 certification in 1996. Of the four Yamawa plants, the Yonezawa location has the longest history of manufacturing and the highest production capacity. Products include roll taps, spiral pointed, pipe and hand taps. The Yonezawa Plant stepped ahead of our competitors by receiving ISO 9001 before any other cutting tool manufacturing in Japan.



The Fukushima plant provides both tap production lines and in-house facilities for the manufacturing of specialized production machine tools to produce the exceptional high quality cutting tools. This plant develops and manufactures special tap and die production equipment. It also supplies these machines to our other manufacturing sites. Products include spiral fluted taps, dies and combined drills/countersinks as well as production machinery.



Equipped with the most sophisticated machine tools available, this plant is famous for its automation and robotized labor saving manufacturing processes. The plant is designed for mass production of the highest quality cutting tools and screw thread tools. Products include spiral fluted taps and carbide taps.



Yamawa Europe S.p.A.
Via Don Federico Tosatto 8
30174 Mestre - Venezia, ITALY

Tel. +39 041 952 543
info@yamawa.eu
www.yamawa.eu



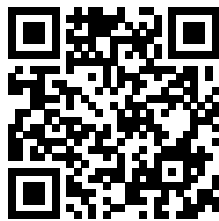

Download the app Tool Finder