

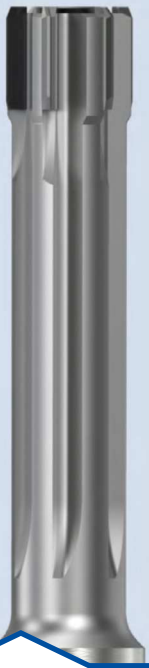

CLICK PDF



Your technology partner for cost-effective machining

# SUPPLEMENTARY VOLUME 2024

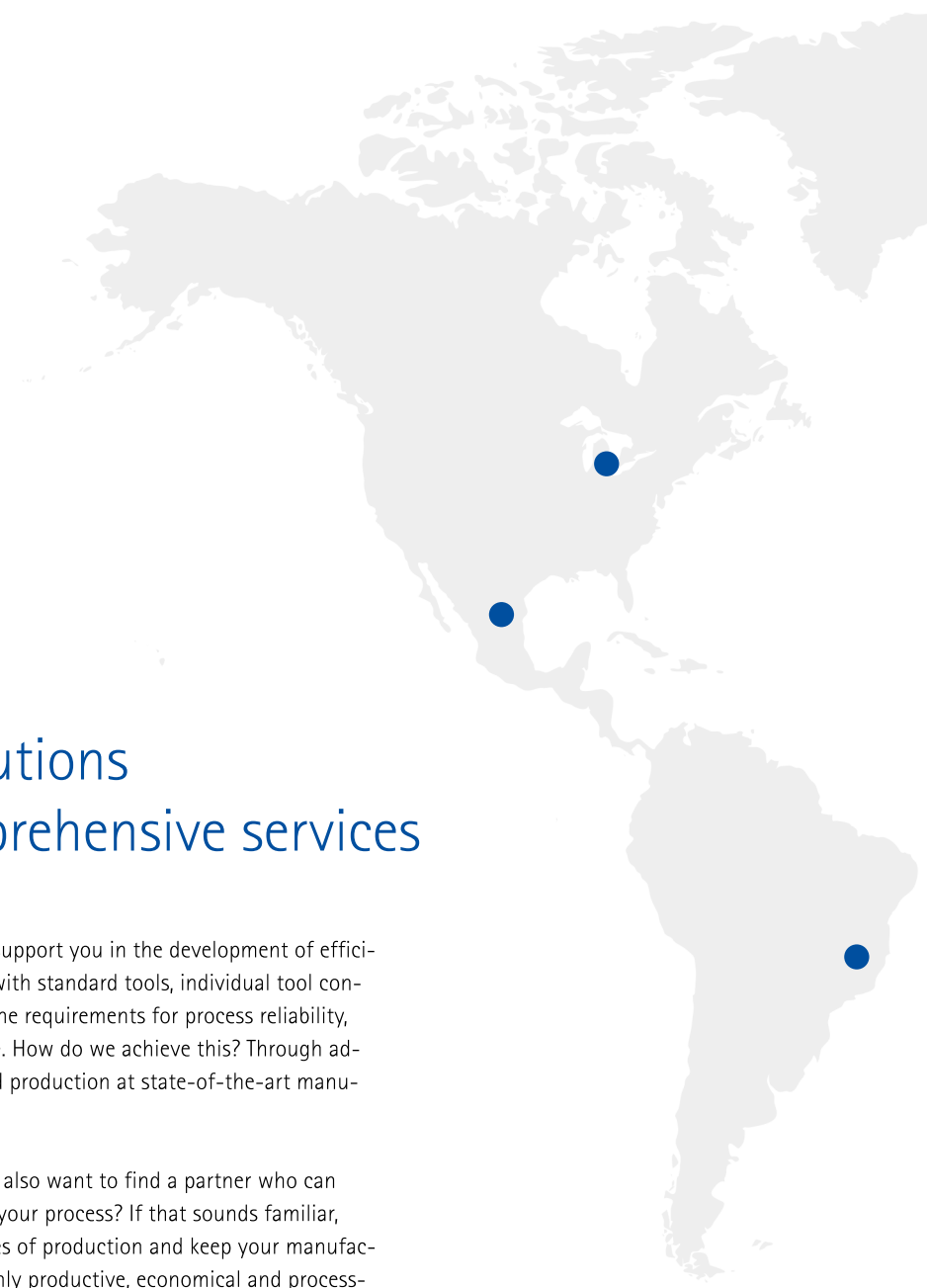

## Tool and process solutions combined with comprehensive services

We see ourselves as a technology partner ready to support you in the development of efficient and resource-saving manufacturing processes with standard tools, individual tool concepts and tool detail optimisation. Our tools meet the requirements for process reliability, offer high levels of precision and are easy to handle. How do we achieve this? Through advanced development and construction methods and production at state-of-the-art manufacturing facilities.

You're looking for the perfect tool for your task but also want to find a partner who can take over and manage the entire planning stage of your process? If that sounds familiar, we're here for you. We support you during all phases of production and keep your manufacturing processes at the highest level – by being highly productive, economical and process-reliable. We also offer you complete networked solutions for all peripheral tasks related to the actual machining process.

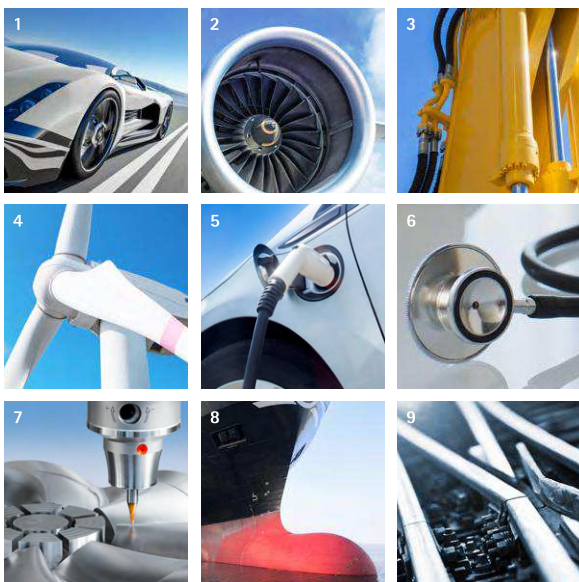

### Sectors

- 1 Automotive
- 2 Aerospace
- 3 Fluid power
- 4 Energy production
- 5 Electric mobility
- 6 Medical technology
- 7 Die & mould making
- 8 Shipbuilding
- 9 Rail transport



Branch offices with production, sales and service in 25 countries

Representatives in over 19 countries

Over  
**5,000**  
employees worldwide

**No. 1**  
technology leader  
for the machining  
of cubic parts

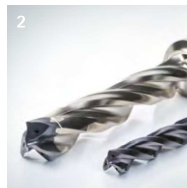

### Product lines

- 1 Reaming and fine boring
- 2 Drilling from solid, boring and countersinking
- 3 Milling
- 4 Turning
- 5 Actuating
- 6 Clamping
- 7 Setting, measuring and dispensing
- 8 Services

# The MAPAL catalogue range

The supplementary volume 2024 contains numerous new products and additions to the range. Together with the catalogue slipcase, it completes the current MAPAL range.



# CONTENTS

## 01 Introduction

Innovations and product range additions 2024 .....	6
--	---

## 02 Bore machining

Drilling from solid .....	10
Tritan-Drill-Alu .....	16
MEGA-Speed-Drill-Titan .....	20
MEGA-Deep-Drill-Steel .....	24
Reaming and fine boring .....	32
FixReam 500 Plus .....	34
FixReam 700 .....	40
NC machine reamer .....	45
HNHX indexable inserts .....	48
Indexable inserts .....	50
Radial indexable inserts CCGT   SCGT .....	52

## 03 Milling

Milling with fixed cutting edges .....	84
OptiMill-Alu-Wave .....	92
OptiMill-Diamond .....	96
OptiMill-Tro-Inox .....	104
OptiMill-Titan-HPC .....	110
PCD full head tool .....	112
Milling cutters with replaceable cutting edges .....	114
NeoMill-T-Finish .....	124
FaceMill-Diamond-ES .....	132
NeoMill-Alu-QBig .....	134
NeoMill-Titan .....	142
TGMill-4-Shell .....	155
Radial indexable insert SPGN .....	158

## 04 Clamping

Clamping technology .....	164
UNIQ – hydraulic clamping technology .....	166
Hollow shank taper-C   hollow shank taper-E – hydraulic clamping technology ..	176
Milling cutter arbor with enlarged face connection diameter ..	215
MQL clamping technology .....	178
MQL technology .....	190

## 05 Technical appendix

Bore machining .....	222
Milling .....	236
General technical information .....	260



# Innovations and product range additions 2024



## Bore machining

Double- and triple-edge solid carbide drills for drilling from solid titanium and aluminium. Deep drill for steel machining.  
New reamers with fixed cutting edges as well as blades for valve seat machining and boring.

► From page 8

## Milling

Solid carbide and PCD end milling cutter for machining titanium, stainless steel and aluminium.  
PCD face milling cutter for the highest surface finishes in aluminium.  
NeoMill product range additions.

► From page 82



## Clamping

UNIQ hydraulic chuck with new connections and lengths.  
Hydraulic chuck MQL, 1-channel and 2-channel system.  
Shrink chuck MQL, 1-channel and 2-channel system.  
Hydraulic chuck with hollow shank taper-C and hollow shank taper-E connection.  
Milling cutter arbor with enlarged face connection, with decentralised coolant delivery.

► From page 162





Tritan-Drill-Alu



MEGA-Speed-Drill-Titan



MEGA-Deep-Drill-Steel



FixReam 500 Plus



FixReam 700



NC machine reamer | MDR



HNHX indexable inserts

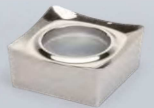

New indexable inserts



OptiMill-Titan-HPC



OptiMill-Alu-Wave



OptiMill-Tro-Inox



OptiMill-Diamond

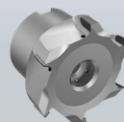

FaceMill-Diamond-ES



NeoMill-T-Finish



NeoMill-Titan-2-Shell



TGMill-4-Shell



NeoMill-Alu-QBig



UNIQ - Hydraulic clamping technology



HSK-C | HSK-E Hydraulic clamping technology



MQL technology



Milling cutter arbor with enlarged face connection diameter

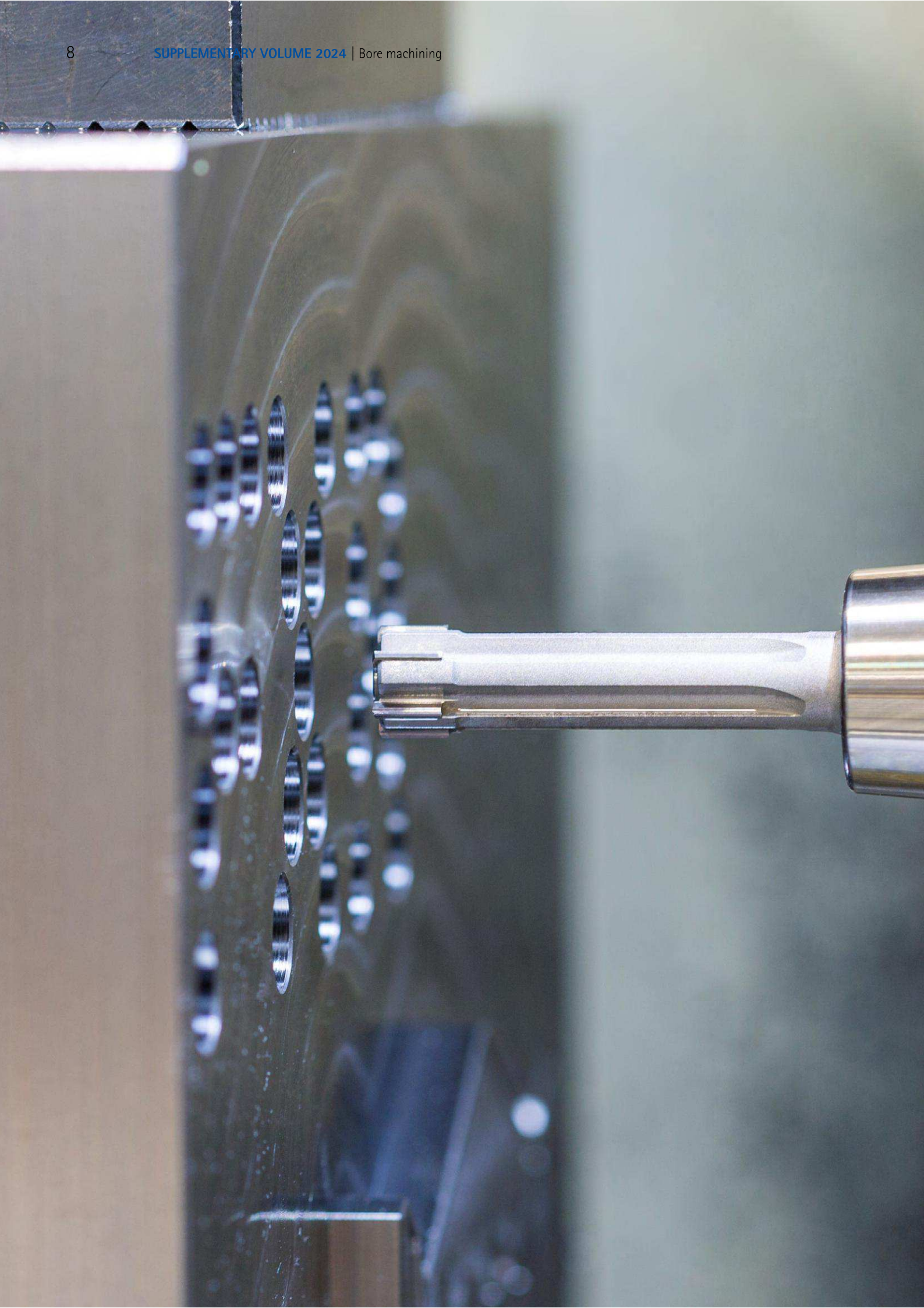



# BORE MACHINING

---

Double- and triple-edge solid carbide drills for drilling from solid titanium and aluminium. Deep drill for steel machining. New reamers with fixed cutting edges as well as blades for valve seat machining and boring.





# Drilling from solid (1/2)

Design	Product category	Material suitability						Bore features							Drilling depth										
		P	M	K	N	C	S	H	HFC	HSC	180°	180°	180°	180°	180°	180°	180°	180°	3xD	4xD	5xD	6xD	8xD	12xD	
Performance LINE		■		■				■				✓	✓					IT9	✓		✓		✓		
		■	■	■	■		■											IT9	✓		✓		✓		
					■													IT9	✓		✓		✓	✓	
								■										IT9		✓					
					■	■												IT9			✓				
		■	■	■														IT9			✓		✓	✓	
		■		■									✓					IT8			✓		✓	✓	
																		IT9			✓		✓	✓	
										✓		✓	✓	✓	✓			IT9			✓		✓	✓	
										✓		✓	✓	✓	✓			IT9	✓		✓		✓	✓	
Expert LINE					■						✓	✓	✓	✓			IT9			✓		✓	✓		
		■	■	■							✓	✓	✓	✓			IT9	✓		✓		✓	✓		
					■						✓	✓	✓	✓			IT9			✓					
		■	■	■							✓						IT9	✓		✓		✓			
		■	■	■							✓						IT9	✓		✓		✓	✓		
		■	■				■				✓						IT9			✓		✓	✓		
								■			✓						IT9			✓					
		■	■	■											✓		IT9	✓		✓					
					■										✓		IT9	✓		✓					
						■											IT9			✓					
Basic LINE		■	■	■													IT9		✓		✓				
		■		■													IT9	✓		✓		✓	✓		
				■	■												IT9			✓		✓			

■ highly suitable      ■ suitable in some situations

Step 1:  
Application

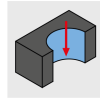

Step 2:  
Design



Step 3:  
Product category



Step 4:  
Material suitability



Step 5:  
Part features



Step 6:  
Design



	Design				Product			Catalogue	
	ø [mm]	z	n <sub>ML</sub> *		Product name	Specification		Main catalogue	Page
	3 - 25	2	2	✓	MEGA-Drill-Steel-Plus	SCD600, 601		✓	
	2 - 20	2	2	✓	MEGA-Drill-Inox	SCD120, 121		✓	
	2,8 - 20	2	2	✓	MEGA-Drill-Alu	SCD131		✓	
	2,55 - 20	2	2		MEGA-Drill-Hardened	SCD140		✓	
	0,5 - 12	2	2		MEGA-Drill-Composite-MD	SCD250		✓	
	0,8 - 2,99	2	2	✓	MICRO-Drill-Steel	SCD371		✓	
	3 - 20	2	4	✓	MEGA-Quadro-Drill-Plus	SCD610, 611		✓	
	4 - 20	3	3	✓	Tritan-Drill-Uni-Plus	SCD631		✓	
	4 - 20	3	3	✓	Tritan-Drill-Steel	SCD661		✓	
	4 - 20	3	3	✓	Tritan-Drill-Alu <b>N</b>	SCD681			16
	3 - 20	2	3	✓	MEGA-Speed-Drill-Uni	SCD221		✓	
	3 - 20	2	3	✓	MEGA-Speed-Drill-Steel	SCD621		✓	
	3 - 20	2	3	✓	MEGA-Speed-Drill-Inox	SCD411		✓	
	3 - 20	2	3	✓	MEGA-Speed-Drill-Titan <b>N</b>	SCD961			20
	3 - 20	2	4	✓	MEGA-180°-Drill	SCD231		✓	
	3 - 20	2	4	✓	MEGA-180°-Drill-Alu	SCD241		✓	
	3 - 12	2	2		MEGA-Drill-Composite-UDX	SCD270, 271		✓	
	3 - 20	2	2	✓	ECU-Drill-Uni	SCD350, 351		✓	
	3 - 20	2	2	✓	ECU-Drill-Steel	SCD360, 361		✓	
	4,8 - 11,6	2	4	✓	ECU-G-Drill	SCD211		✓	

\* n<sub>ML</sub> = Number of margin lands

**N** New

**+** Range additions



# Drilling from solid (2/2)

Design	Product category	Material suitability						Bore features							Drilling depth									
		P	M	K	N	S	H	HFC	HSC	Fluted	Double-fluted	Single-fluted	Double-fluted	180°	Tolerance	1xD	1.5xD	3xD	5xD	8xD	12xD			
	Performance LINE	■		■												IT9	✓		✓	✓	✓	✓		
		■		■													IT9	✓		✓	✓	✓	✓	
		■	■	■	■		■										IT9	✓		✓	✓	✓	✓	
					■												IT9	✓		✓	✓	✓	✓	
						■											IT9	✓		✓	✓	✓	✓	
	Expert LINE	■		■				✓		✓	✓	✓	✓		IT9			✓	✓	✓				
		■		■												IT10		✓	✓	✓	✓	✓		
		■		■						✓	✓					IT10		✓	✓	✓	✓	✓		
		■		■												IT10		✓	✓	✓	✓	✓		
		■	■	■												IT10		✓	✓	✓	✓	✓		
					■											IT10		✓	✓	✓	✓	✓		
	Performance LINE				■										IT9	✓	✓	✓						

■ highly suitable      ◻ suitable in some situations

Step 1:  
Application

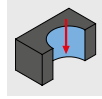

Step 2:  
Design



Step 3:  
Product category



Step 4:  
Material suitability



Step 5:  
Part features



Step 6:  
Design



	Design				Product			Catalogue	
	ø [mm]	z	n <sub>ML</sub> *		Product name	Specification		Main catalogue	Page
	12 - 45	2	4	✓	TTD Uni-Plus replaceable drill head	01-Uni-Plus		✓	
	12 - 45	2	3	✓	TTD Steel replaceable drill head	04-Steel		✓	
	12 - 45	2	3	✓	TTD Inox replaceable drill head	02-Inox		✓	
	12 - 45	2	4	✓	TTD Iron replaceable drill head	05-Iron		✓	
	12 - 45	2	4	✓	TTD Alu replaceable drill head	03-Alu		✓	
	12 - 32,49	3	3	✓	TTD-Tritan Uni replaceable drill head	01-Uni		✓	
	9 - 50	2	2	✓	QTD Steel Indexable Insert	01-Steel		✓	
	14 - 32	2	2	✓	QTD Steel Indexable Insert with pyramid tip	05-Pyramid		✓	
	10 - 33	2	2	✓	QTD Uni EK-Shaped Indexable Insert	10-Uni		✓	
	9 - 50	2	2	✓	QTD Inox Indexable Insert	02-Inox		✓	
	9 - 50	2	2	✓	QTD Iron Indexable Insert	04-Iron		✓	
	9 - 50	2	2	✓	QTD Alu Indexable Insert	03-Alu		✓	
	16 - 54,9	1	4	✓	WOGT Indexable Insert	WOGT-X40		✓	

\* n<sub>ML</sub> = Number of margin lands

New

Range additions

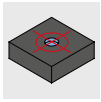

## Spot drilling

Design	Product category	Material suitability						Bore features							Drilling depth							
		P	M	K	N	S	H	HFC	HSC						Tolerance	1xD	1.5xD	3xD	5xD	8xD	12xD	
	Expert LINE	■	■	■	■	■	■															
	Basic LINE	■	■	■	■	■	■															
	Basic LINE	■	■	■	■	■	■															

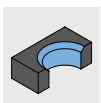

## Stepped drilling

Design	Product category	Material suitability						Bore features							Drilling depth							
		P	M	K	N	S	H	HFC	HSC						Tolerance	1xD	1.5xD	3xD	5xD	8xD	12xD	
	Expert LINE	■	■	■	■	■	■	✓							IT9							
	Performance LINE	■	■	■	■	■	■								IT9							

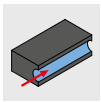

## Deep drilling

Design	Product category	Material suitability						Bore features							Drilling depth							
		P	M	K	N	S	H	HFC	HSC							Tolerance	15xD	20xD	25xD	30xD	40xD	
	Performance LINE	■	■	■	■	■	■															
		■	■	■	■	■	■							✓	IT9	✓	✓	✓	✓	✓		
		■	■	■	■	■	■							✓	IT9		✓	✓	✓	✓		

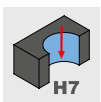

## Drilling reaming

Design	Product category	Material suitability						Bore features							Drilling depth							
		P	M	K	N	S	H	HFC	HSC						Tolerance	1xD	1.5xD	3xD	5xD	8xD	12xD	
	Expert LINE	■	■	■	■	■	■				✓	✓	✓	✓	IT7			✓	✓			

■ highly suitable

■ suitable in some situations

Step 1:  
Application

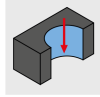

Step 2:  
Design



Step 3:  
Product category



Step 4:  
Material suitability



Step 5:  
Part features



Step 6:  
Design



Design					Product			Catalogue	
ø [mm]	z	n <sub>ML</sub> *			Product name	Specification		Main catalogue	Page
4 - 20	3	0			Tritan-Spot-Drill-Steel	SCD670		✓	
0,5 - 2,5	2	2			ECU-Centre-Drill	SCD450		✓	
8 - 20	2	0			CPD-Spot-Drill	CPD100		✓	

Design					Product			Catalogue	
ø [mm]	z	n <sub>ML</sub> *			Product name	Specification		Main catalogue	Page
3,98 - 17,50	3	3	✓		Tritan-Step-Drill-Steel	SCD561		✓	
2,5 - 14	2	2	✓		MEGA-Step-Drill-Steel-Plus	SCD590, 591		✓	

Design					Product			Catalogue	
ø [mm]	z	n <sub>ML</sub> *			Product name	Specification		Main catalogue	Page
1 - 3	2	2	✓		MEGA-Pilot-Drill	SCD581		✓	
3 - 16	2	4	✓		MEGA-Deep-Drill-Steel <span style="background-color: yellow; border-radius: 50%; padding: 2px;">N</span>	SCD701			24
3 - 12	2	4	✓		MEGA-Deep-Drill-Alu	SCD181		✓	

Design					Product			Catalogue	
ø [mm]	z	n <sub>ML</sub> *			Product name	Specification		Main catalogue	Page
3,80 - 20,05	3		✓		Tritan-Drill-Reamer	SDR301		✓	

\* n<sub>ML</sub> = Number of margin lands

N New

+ Range additions

# Tritan-Drill-Alu

## The high-feed drilling specialist for use in aluminium

MAPAL has developed the Tritan-Drill-Alu especially for the high-feed machining of aluminium. The three-edge solid carbide drill has a matched, finely ground groove profile. Large chip spaces and a special, sharp cutting-edge finish guarantee optimum chip formation, reduce heat build-up and ensure reliable chip removal.

### 1 Three blades

- High-feed machining with maximum feed rates

### 2 Extra-large chip spaces with finely ground chip flute profile

- Safe removal of chips

### 3 Self-centring drill tip

- Best positioning accuracy

### 4 Sharply prepared cutting edge

- Optimal chip formation

### 5 Three margin lands

- For perfect guiding properties



## Features

### Dimensions:

- Number of cutting edges: 3
- Shank form: HA
- 5xD with internal coolant supply

### Preferred series available from stock:

- Ø area: 4.00 to 16.00 mm

### Configurable features:

- Ø area: 4.00 to 20.00 mm
- Shank form: HB, HE
- Coating: CVD coating



## Machining time in AlSi1MgMn [sec.]

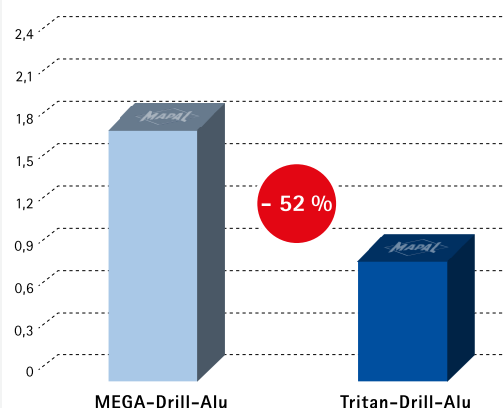

### MEGA-Drill-Alu (z=2)

Tool ø: 10.00 mm  
 lB: 50 (5xD)  
 $v_c$ : 300 m/min  
 $f_u$ : 0.19 mm/rev  
 th: 1.78 s

### Tritan-Drill-Alu (z=3)

Tool ø: 10.00 mm  
 lB: 50 (5xD)  
 $v_c$ : 300 m/min  
 $f_u$ : 0.4 mm/rev  
 th: 0.85 s



# Tritan-Drill-Alu

Solid carbide twist drill  
SCD681 (5xD), internal coolant supply

**Design:**

Drill diameter: 4.00 - 20.00 mm  
Bore tolerance:  $\geq$  IT 9  
Cutting material: HU318  
Number of cutting edges: 3  
Number of margin lands: 3  
Tip angle: 130°  
Helix angle: 30°

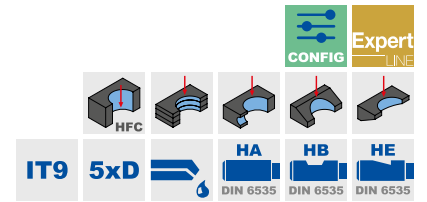
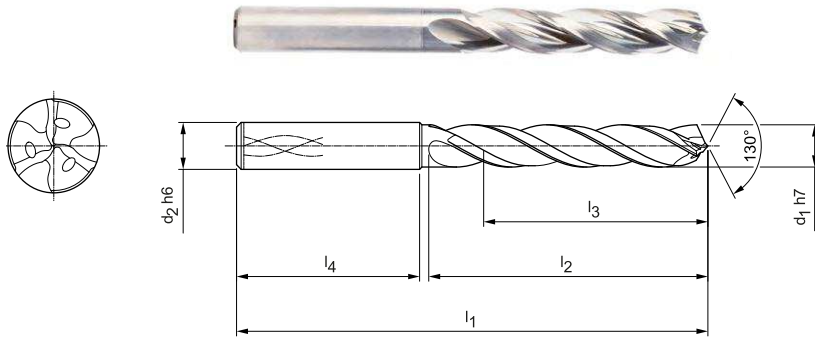

**Preferred series available from stock**

Dimensions						Shank form HA	
d <sub>1</sub> h7	d <sub>2</sub> h6	l <sub>1</sub>	l <sub>2</sub>	l <sub>3</sub>	l <sub>4</sub>	Specification	Order no.
4,00	6	74	36	29	36	SCD681-0400-3-3-130HA05-HU318	31307609
4,10	6	74	36	29	36	SCD681-0410-3-3-130HA05-HU318	31307610
4,20	6	74	36	29	36	SCD681-0420-3-3-130HA05-HU318	31307611
4,30	6	74	36	29	36	SCD681-0430-3-3-130HA05-HU318	31307612
4,50	6	74	36	29	36	SCD681-0450-3-3-130HA05-HU318	31307613
4,60	6	74	36	29	36	SCD681-0460-3-3-130HA05-HU318	31307614
4,65	6	74	36	29	36	SCD681-0465-3-3-130HA05-HU318	31307615
4,80	6	82	44	35	36	SCD681-0480-3-3-130HA05-HU318	31307616
4,90	6	82	44	35	36	SCD681-0490-3-3-130HA05-HU318	31307617
5,00	6	82	44	35	36	SCD681-0500-3-3-130HA05-HU318	31307618
5,10	6	82	44	35	36	SCD681-0510-3-3-130HA05-HU318	31307619
5,20	6	82	44	35	36	SCD681-0520-3-3-130HA05-HU318	31307620
5,30	6	82	44	35	36	SCD681-0530-3-3-130HA05-HU318	31307621
5,50	6	82	44	35	36	SCD681-0550-3-3-130HA05-HU318	31307622
5,55	6	82	44	35	36	SCD681-0555-3-3-130HA05-HU318	31307623
5,60	6	82	44	35	36	SCD681-0560-3-3-130HA05-HU318	31307624
5,80	6	82	44	35	36	SCD681-0580-3-3-130HA05-HU318	31307625
5,90	6	82	44	35	36	SCD681-0590-3-3-130HA05-HU318	31307626
6,00	6	82	44	35	36	SCD681-0600-3-3-130HA05-HU318	31307627
6,10	8	91	53	43	36	SCD681-0610-3-3-130HA05-HU318	31307628
6,20	8	91	53	43	36	SCD681-0620-3-3-130HA05-HU318	31307629
6,30	8	91	53	43	36	SCD681-0630-3-3-130HA05-HU318	31307630
6,40	8	91	53	43	36	SCD681-0640-3-3-130HA05-HU318	31307631
6,50	8	91	53	43	36	SCD681-0650-3-3-130HA05-HU318	31307632
6,60	8	91	53	43	36	SCD681-0660-3-3-130HA05-HU318	31307633
6,80	8	91	53	43	36	SCD681-0680-3-3-130HA05-HU318	31307634
6,90	8	91	53	43	36	SCD681-0690-3-3-130HA05-HU318	31307635
7,00	8	91	53	43	36	SCD681-0700-3-3-130HA05-HU318	31307636
7,40	8	91	53	43	36	SCD681-0740-3-3-130HA05-HU318	31307637
7,45	8	91	53	43	36	SCD681-0745-3-3-130HA05-HU318	31307638
7,50	8	91	53	43	36	SCD681-0750-3-3-130HA05-HU318	31307639
7,80	8	91	53	43	36	SCD681-0780-3-3-130HA05-HU318	31307640
8,00	8	91	53	43	36	SCD681-0800-3-3-130HA05-HU318	31307641
8,10	10	103	61	49	40	SCD681-0810-3-3-130HA05-HU318	31307642
8,40	10	103	61	49	40	SCD681-0840-3-3-130HA05-HU318	31307643

## Tritan-Drill-Alu | Solid carbide twist drill SCD681 (5xD), internal coolant supply

Dimensions						Shank form HA	
$d_1$ h7	$d_2$ h6	$l_1$	$l_2$	$l_3$	$l_4$	Specification	Order no.
8,50	10	103	61	49	40	SCD681-0850-3-3-130HA05-HU318	31307644
8,80	10	103	61	49	40	SCD681-0880-3-3-130HA05-HU318	31307645
9,00	10	103	61	49	40	SCD681-0900-3-3-130HA05-HU318	31307646
9,10	10	103	61	49	40	SCD681-0910-3-3-130HA05-HU318	31307647
9,80	10	103	61	49	40	SCD681-0980-3-3-130HA05-HU318	31307648
10,00	10	103	61	49	40	SCD681-1000-3-3-130HA05-HU318	31307649
10,20	12	118	71	56	45	SCD681-1020-3-3-130HA05-HU318	31307650
10,50	12	118	71	56	45	SCD681-1050-3-3-130HA05-HU318	31307651
11,00	12	118	71	56	45	SCD681-1100-3-3-130HA05-HU318	31307652
11,50	12	118	71	56	45	SCD681-1150-3-3-130HA05-HU318	31307653
11,80	12	118	71	56	45	SCD681-1180-3-3-130HA05-HU318	31307654
12,00	12	118	71	56	45	SCD681-1200-3-3-130HA05-HU318	31307655
12,50	14	124	77	60	45	SCD681-1250-3-3-130HA05-HU318	31307656
13,00	14	124	77	60	45	SCD681-1300-3-3-130HA05-HU318	31307657
14,00	14	124	77	60	45	SCD681-1400-3-3-130HA05-HU318	31307658
15,00	16	133	83	63	48	SCD681-1500-3-3-130HA05-HU318	31307659
16,00	16	133	83	63	48	SCD681-1600-3-3-130HA05-HU318	31307660

## Configurable features



**Diameter:**  
Diameter in increments of  
0.01 mm freely selectable



**Shank form:**  
Shank form: HB | HE



**Coating:**  
Available as DLC coating with cutting material HP910



## Specification:

SCD681-[diameter]-3-3-130[shank form]05-[coating]

## Dimensions of configurable series

$d_1$ min.	$d_1$ max.	$d_2$ h6	$l_1$	$l_2$	$l_3$	$l_4$
4,00	4,70	6	74	36	29	36
4,71	6,00	6	82	44	35	36
6,01	7,00	8	91	53	43	36
7,01	8,00	8	91	53	43	36
8,01	9,00	10	103	61	49	40
9,01	10,00	10	103	61	49	40
10,01	11,00	12	118	71	56	45
11,01	12,00	12	118	71	56	45
12,01	14,00	14	124	77	60	45
14,01	16,00	16	133	83	63	48
16,01	18,00	18	143	93	71	48
18,01	20,00	20	153	101	77	50

## Example:

SCD681-0431-3-3-130HE05-HP910

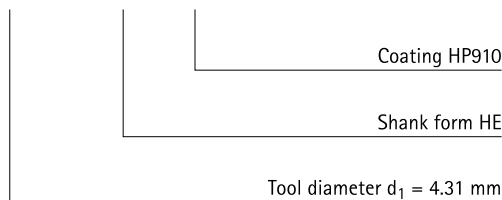

Dimensions in mm.

For cutting data recommendations, see chapter "Technical Appendix".

Special designs and other coatings available upon request.



# MEGA-Speed-Drill-Titan

## Cost-efficient and productive

The double-edge high-speed drill is equipped with four margin lands for optimum roundness. To bring the maximum coolant flow to the main cutter, the coolant is directed backwards along the shell surface. In this way, the guiding chamfers experience maximum cooling, dissipating the heat generated effectively. The convex main cutter edge ensures high stability and long tool life.

### 1 Face geometry

- Convex cutting edge with corner chamfer for high stability

### 2 Innovative cooling ribs

- Protects the margin lands
- Maximum coolant supply at the bore wall
- Maximum heat and wear resistance

### 3 Four margin lands

- Precise surface accuracy and cylindricity

### 4 Heat-resistant coating

- Smooth TiAlSiN-PVD coating based on the novel HiPIMS technology provides maximum tool life

### 5 Highly polished chip flutes

- Process-reliable chip removal

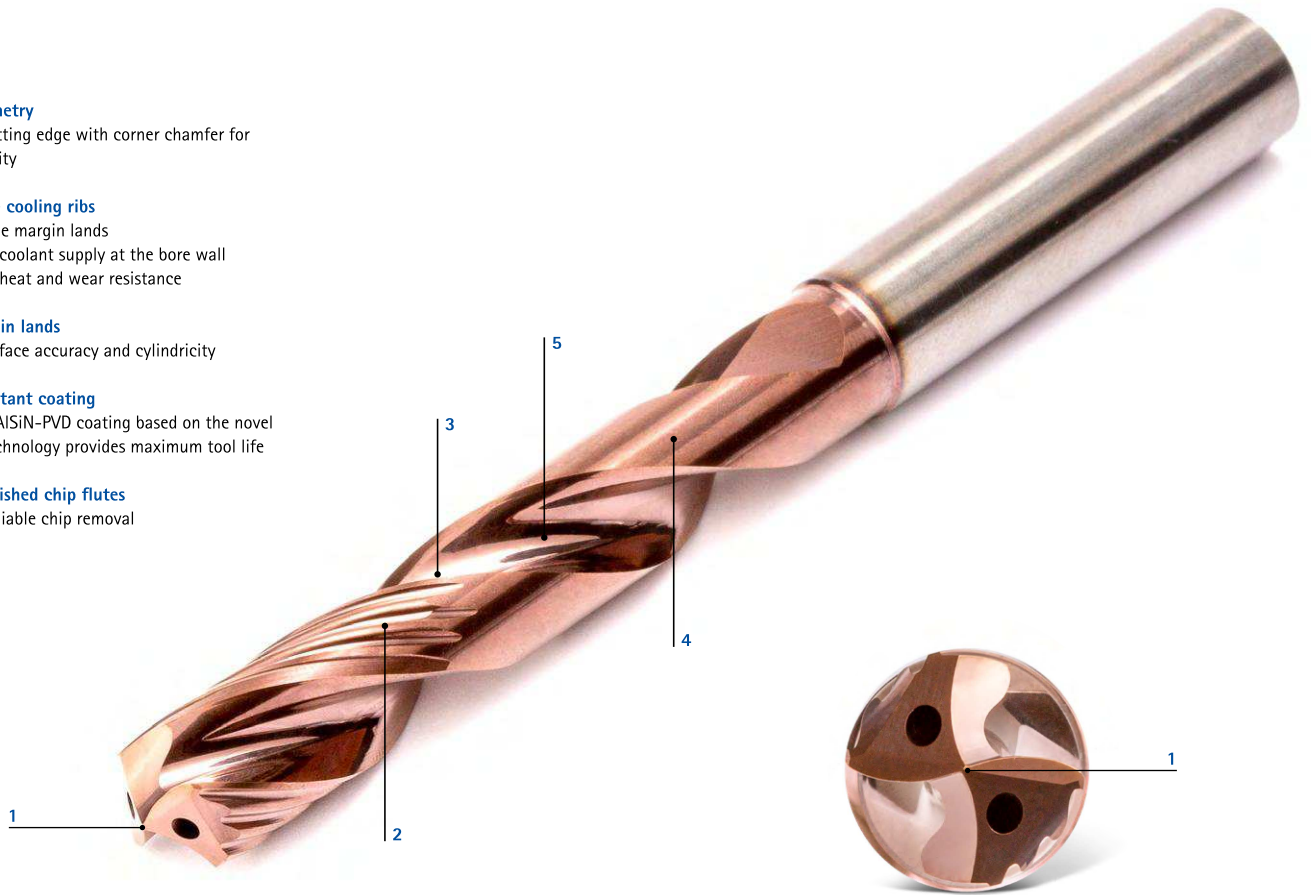

## Features

### Dimensions:

- Number of cutting edges: 2
- Shank form: HA
- 5xD with internal coolant supply

### Preferred series available from stock:

- $\varnothing$  area: 3.00 to 16.00 mm

### Configurable features:

- $\varnothing$  area: 3.00 to 20.00 mm
- Shank form: HB, HE

## Tool life [m]

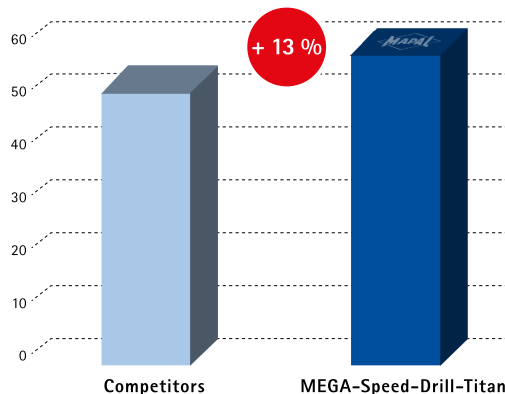

### TiAl6V4-1.1800

Nominal  $\varnothing$ : 8.50 mm

$v_c$ : 40 m/min

$f_u$ : 0.2 mm/rev

# MEGA-Speed-Drill-Titan

Solid carbide twist drill  
SCD961 (5xD), internal coolant supply

**Design:**  
 Drill diameter: 3.00 - 20.00 mm  
 Bore tolerance: IT 9 (accessible)  
 Cutting material: HP184  
 Number of cutting edges: 2  
 Number of margin lands: 4  
 Tip angle: 140°  
 Helix angle: 30°

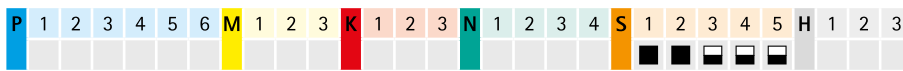
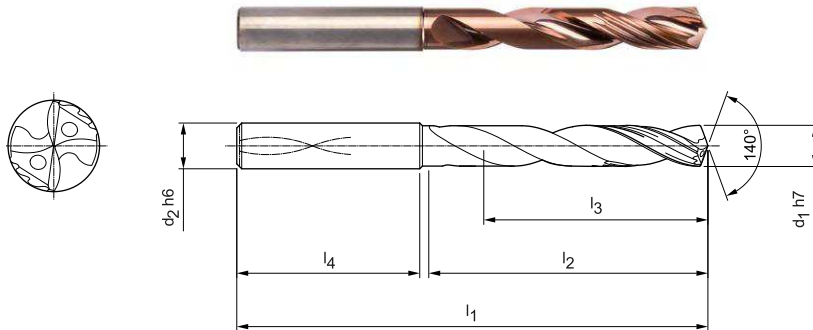

Preferred series available from stock

Dimensions						Shank form HA	
d <sub>1</sub> h7	d <sub>2</sub> h6	l <sub>1</sub>	l <sub>2</sub>	l <sub>3</sub>	l <sub>4</sub>	Specification	Order no.
3,00	6	66	28	23	36	SCD961-0300-2-4-140HA05-HP184	31315779
3,10	6	66	28	23	36	SCD961-0310-2-4-140HA05-HP184	31315820
3,20	6	66	28	23	36	SCD961-0320-2-4-140HA05-HP184	31315821
3,30	6	66	28	23	36	SCD961-0330-2-4-140HA05-HP184	31315822
3,40	6	66	28	23	36	SCD961-0340-2-4-140HA05-HP184	31315823
3,50	6	66	28	23	36	SCD961-0350-2-4-140HA05-HP184	31315824
3,60	6	66	28	23	36	SCD961-0360-2-4-140HA05-HP184	31315825
3,70	6	66	28	23	36	SCD961-0370-2-4-140HA05-HP184	31315826
3,80	6	74	36	29	36	SCD961-0380-2-4-140HA05-HP184	31315827
4,00	6	74	36	29	36	SCD961-0400-2-4-140HA05-HP184	31315828
4,10	6	74	36	29	36	SCD961-0410-2-4-140HA05-HP184	31315829
4,20	6	74	36	29	36	SCD961-0420-2-4-140HA05-HP184	31315830
4,30	6	74	36	29	36	SCD961-0430-2-4-140HA05-HP184	31315831
4,40	6	74	36	29	36	SCD961-0440-2-4-140HA05-HP184	31315832
4,50	6	74	36	29	36	SCD961-0450-2-4-140HA05-HP184	31315833
4,60	6	74	36	29	36	SCD961-0460-2-4-140HA05-HP184	31315834
4,70	6	74	36	29	36	SCD961-0470-2-4-140HA05-HP184	31315835
4,80	6	82	44	35	36	SCD961-0480-2-4-140HA05-HP184	31315836
5,00	6	82	44	35	36	SCD961-0500-2-4-140HA05-HP184	31315837
5,10	6	82	44	35	36	SCD961-0510-2-4-140HA05-HP184	31315838
5,20	6	82	44	35	36	SCD961-0520-2-4-140HA05-HP184	31315839
5,30	6	82	44	35	36	SCD961-0530-2-4-140HA05-HP184	31315840
5,40	6	82	44	35	36	SCD961-0540-2-4-140HA05-HP184	31315841
5,50	6	82	44	35	36	SCD961-0550-2-4-140HA05-HP184	31315842
5,80	6	82	44	35	36	SCD961-0580-2-4-140HA05-HP184	31315843
5,90	6	82	44	35	36	SCD961-0590-2-4-140HA05-HP184	31315844
6,00	6	82	44	35	36	SCD961-0600-2-4-140HA05-HP184	31315845
6,20	8	91	53	43	36	SCD961-0620-2-4-140HA05-HP184	31315846
6,50	8	91	53	43	36	SCD961-0650-2-4-140HA05-HP184	31315847
6,60	8	91	53	43	36	SCD961-0660-2-4-140HA05-HP184	31315848
6,80	8	91	53	43	36	SCD961-0680-2-4-140HA05-HP184	31315849
7,00	8	91	53	43	36	SCD961-0700-2-4-140HA05-HP184	31315850
7,10	8	91	53	43	36	SCD961-0710-2-4-140HA05-HP184	31315851
7,30	8	91	53	43	36	SCD961-0730-2-4-140HA05-HP184	31315852
7,40	8	91	53	43	36	SCD961-0740-2-4-140HA05-HP184	31315853

## MEGA-Speed-Drill-Titan | Solid carbide twist drill SCD961 (5xD), internal coolant supply

Dimensions						Shank form HA	
d <sub>1</sub> h7	d <sub>2</sub> h6	l <sub>1</sub>	l <sub>2</sub>	l <sub>3</sub>	l <sub>4</sub>	Specification	Order no.
7,50	8	91	53	43	36	SCD961-0750-2-4-140HA05-HP184	31315854
7,80	8	91	53	43	36	SCD961-0780-2-4-140HA05-HP184	31315855
8,00	8	91	53	43	36	SCD961-0800-2-4-140HA05-HP184	31315856
8,10	10	103	61	49	40	SCD961-0810-2-4-140HA05-HP184	31315857
8,20	10	103	61	49	40	SCD961-0820-2-4-140HA05-HP184	31315858
8,30	10	103	61	49	40	SCD961-0830-2-4-140HA05-HP184	31315859
8,40	10	103	61	49	40	SCD961-0840-2-4-140HA05-HP184	31315860
8,50	10	103	61	49	40	SCD961-0850-2-4-140HA05-HP184	31315861
8,80	10	103	61	49	40	SCD961-0880-2-4-140HA05-HP184	31315862
9,00	10	103	61	49	40	SCD961-0900-2-4-140HA05-HP184	31315863
9,80	10	103	61	49	40	SCD961-0980-2-4-140HA05-HP184	31315864
10,00	10	103	61	49	40	SCD961-1000-2-4-140HA05-HP184	31315865
10,20	12	118	71	56	45	SCD961-1020-2-4-140HA05-HP184	31315866
10,50	12	118	71	56	45	SCD961-1050-2-4-140HA05-HP184	31315867
11,00	12	118	71	56	45	SCD961-1100-2-4-140HA05-HP184	31315868
11,80	12	118	71	56	45	SCD961-1180-2-4-140HA05-HP184	31315869
12,00	12	118	71	56	45	SCD961-1200-2-4-140HA05-HP184	31315870
12,50	14	124	77	60	45	SCD961-1250-2-4-140HA05-HP184	31315871
13,00	14	124	77	60	45	SCD961-1300-2-4-140HA05-HP184	31315872
13,50	14	124	77	60	45	SCD961-1350-2-4-140HA05-HP184	31315873
14,00	14	124	77	60	45	SCD961-1400-2-4-140HA05-HP184	31315874
15,80	16	133	83	63	48	SCD961-1580-2-4-140HA05-HP184	31315875
16,00	16	133	83	63	48	SCD961-1600-2-4-140HA05-HP184	31315876

## Configurable features



**Diameter:**  
Diameter in increments of 0.01 mm freely selectable



**Shank form:**  
Shank form: HB | HE

**Specification:**  
SCD961-[diameter]-2-4-140[shank form]05-HP184

**Example:**  
SCD961-0470-2-4-140HE05-HP184

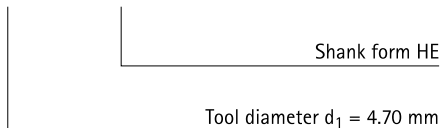

## Dimensions of configurable series

d <sub>1</sub> min.	d <sub>1</sub> max.	d <sub>2</sub> h6	l <sub>1</sub>	l <sub>2</sub>	l <sub>3</sub>	l <sub>4</sub>
3,00	3,70	6	66	28	23	36
3,71	4,70	6	74	36	29	36
4,71	6,00	6	82	44	35	36
6,01	6,80	8	91	53	43	36
6,81	8,00	8	91	53	43	36
8,01	9,00	10	103	61	49	40
9,01	10,00	10	103	61	49	40
10,01	11,00	12	118	71	56	45
11,01	12,00	12	118	71	56	45
12,01	14,00	14	124	77	60	45
14,01	16,00	16	133	83	63	48
16,01	18,00	18	143	93	71	48
18,01	20,00	20	153	101	77	50

Dimensions in mm.

For cutting data recommendations, see chapter "Technical Appendix".

Special designs and other coatings available upon request.



# MEGA-Deep-Drill-Steel

## Efficient deep drilling up to 40xD

The new MEGA-Deep-Drill-Steel is a deep drill for highly efficient deep drilling applications on steel and cast-iron materials. Due to its innovative geometrical and cutting material design, the deep drill is ideally adapted to high feed rates and maximum productivity in bore machining up to 40xD.

The spherical cutting edge and the optimised core diameter profile result in excellent cutting properties with maximum stability. The cooling channel diameters were enlarged by approx. 20% to ensure optimal cooling of the main cutters and cutting edges as well as improved chip

removal. The deep drill is suitable for emulsion and MQL on machining centres with a coolant pressure of 10–40 bar.

The four margin lands ensure exact boring accuracy and a very low bore pattern. The adapted guide length and the widened rear margin lands ensure maximum guiding accuracy even with inclined bore outlets. With its smooth surface, the HiPIMS head coating enables maximum tool life with smooth chip flow.

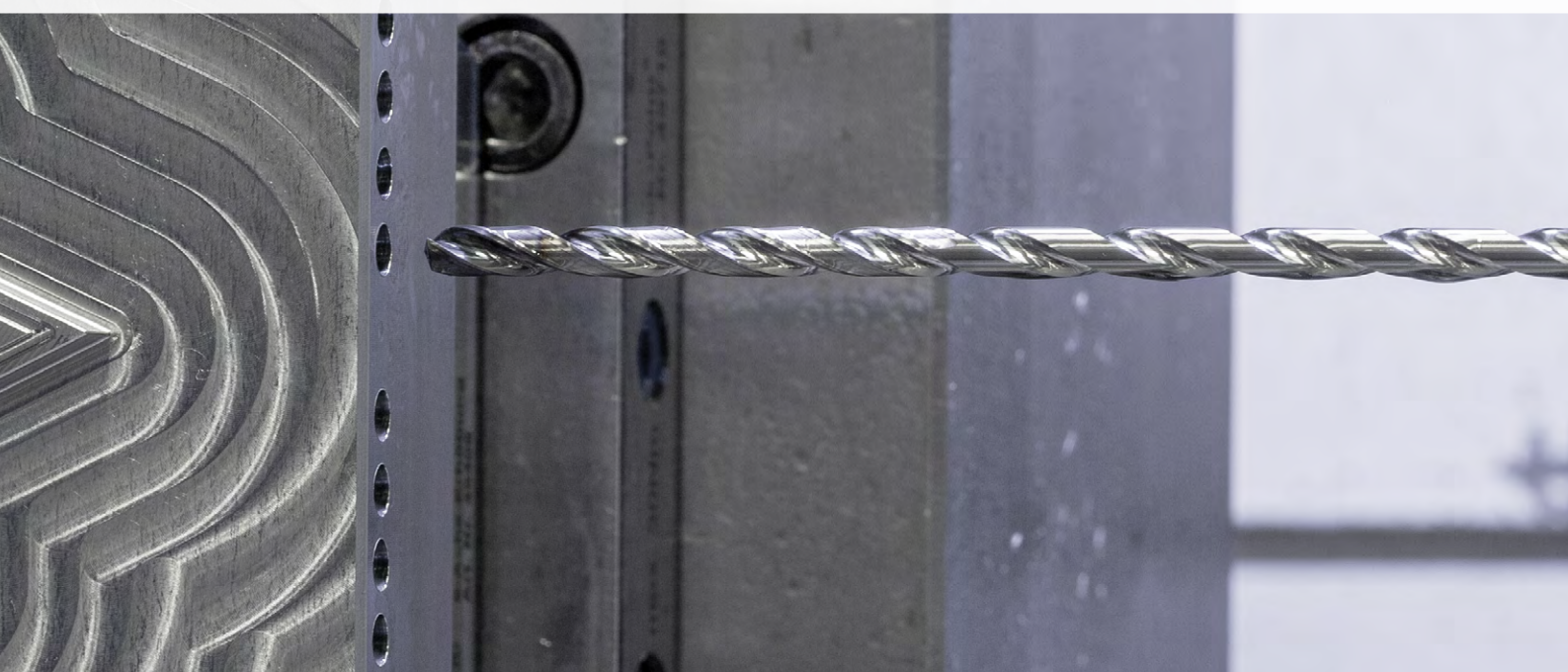

### ✓ HIGH WEAR RESISTANCE

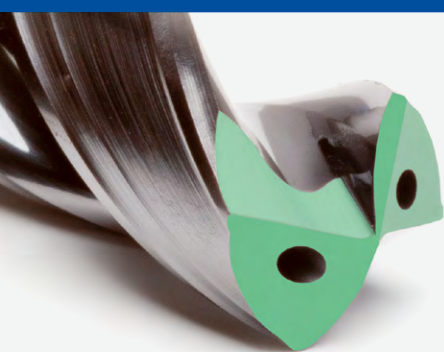

#### Good cutting properties, short chips

- Spherical main cutter

#### Maximum tool life

- Innovative cutting material

#### Maximum stability

- Perfectly adapted core diameter profile

### ⚙️ PROCESS RELIABILITY



#### Exact boring accuracy

- Thanks to 4 margin lands

#### Very low bore pattern

- Thanks to the larger circumference surface area of the rear chamfers

#### Maximum guiding accuracy even with angled bore outlets

- Ideal length of margin lands





Steel workpiece materials

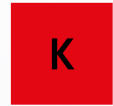

Cast iron materials

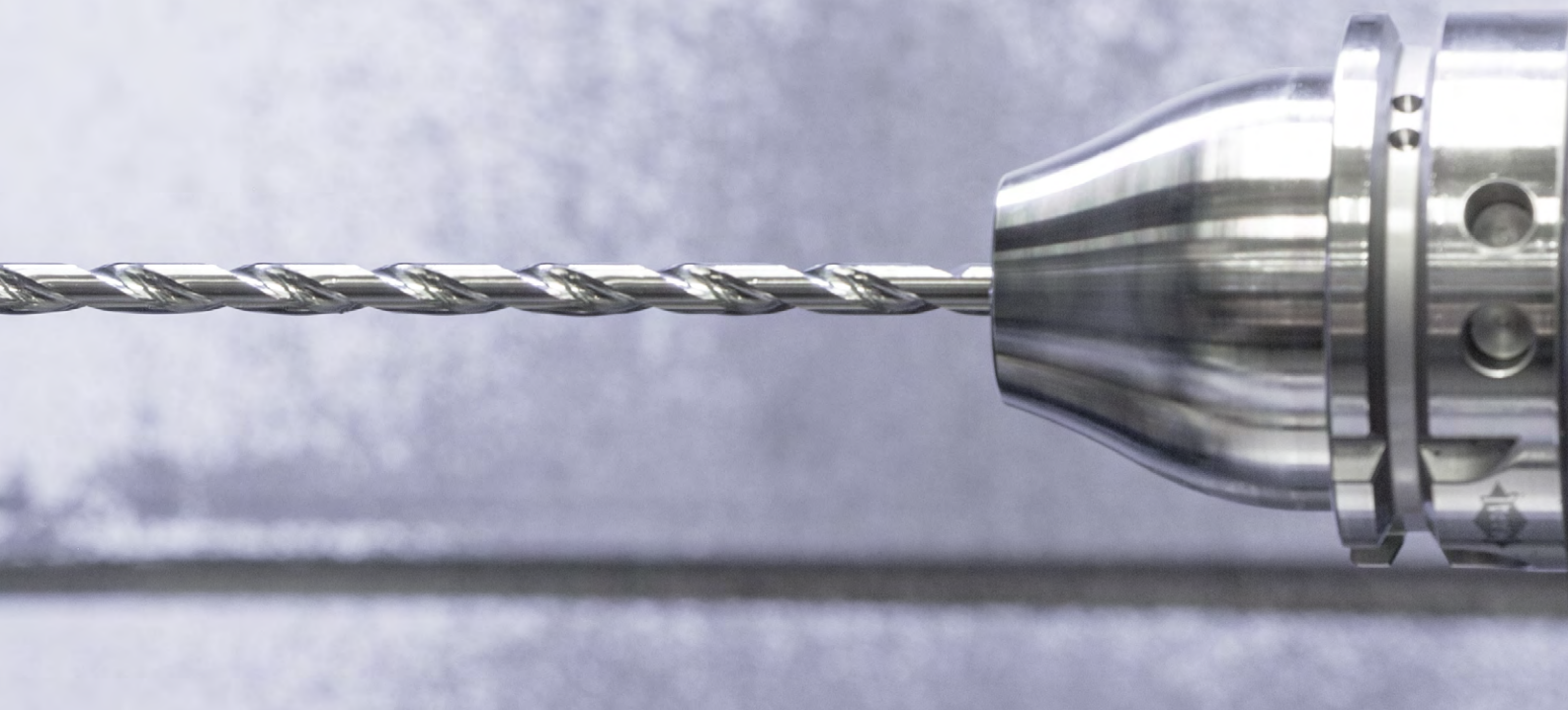

## MAXIMUM PRODUCTIVITY

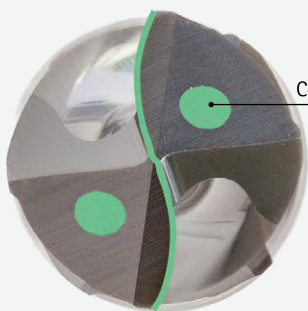

Cooling channel- $\varnothing$  + 20%

### Good cutting properties and maximum feed rates

- Spherical main cutter
- Maximum cooling power
- Maximum cutting stability

### Ideal chip removal

- Tightly rolled chips

### Maximum tool life according to the number of bores

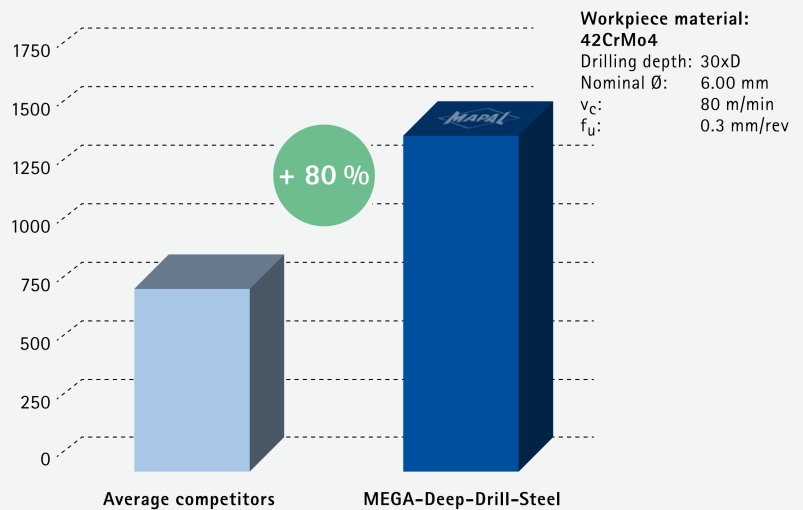

# MEGA-Deep-Drill-Steel

Solid carbide twist drill  
SCD701 (15xD), internal coolant supply

**Design:**  
 Drill diameter: 3.00 - 16.00 mm  
 Bore tolerance: IT9 (available)  
 Shank form: HA  
 Cutting material: HP400  
 Number of cutting edges: 2  
 Tip angle: 137°  
 Helix angle: 30°  
 Special features: Head coating

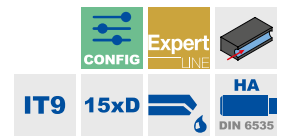
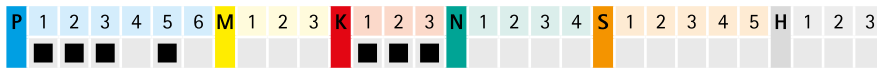
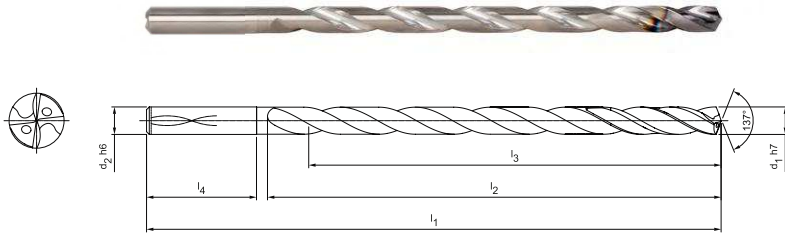

Preferred series available from stock

Dimensions						Shank form HA	
d <sub>1</sub> h7	d <sub>2</sub> h6	l <sub>1</sub>	l <sub>2</sub>	l <sub>3</sub>	l <sub>4</sub>	Specification	Order no.
3,00	4,00	90	58	52	28	SCD701-0300-2-4-137HA15-HP400	31459705
3,50	4,00	98	66	60	28	SCD701-0350-2-4-137HA15-HP400	31459706
4,00	4,00	98	66	60	28	SCD701-0400-2-4-137HA15-HP400	31459707
4,50	5,00	107	75	68	28	SCD701-0450-2-4-137HA15-HP400	31459708
5,00	5,00	115	83	75	28	SCD701-0500-2-4-137HA15-HP400	31459709
5,50	6,00	131	91	83	36	SCD701-0550-2-4-137HA15-HP400	31459720
6,00	6,00	139	99	90	36	SCD701-0600-2-4-137HA15-HP400	31459721
7,00	8,00	156	116	105	36	SCD701-0700-2-4-137HA15-HP400	31459722
8,00	8,00	172	132	120	36	SCD701-0800-2-4-137HA15-HP400	31459723
9,00	10,00	193	149	135	40	SCD701-0900-2-4-137HA15-HP400	31459724
9,50	10,00	209	165	150	40	SCD701-0950-2-4-137HA15-HP400	31459725
10,00	10,00	209	165	150	40	SCD701-1000-2-4-137HA15-HP400	31459726
11,00	12,00	231	182	165	45	SCD701-1100-2-4-137HA15-HP400	31459727
12,00	12,00	247	198	180	45	SCD701-1200-2-4-137HA15-HP400	31459728
13,00	14,00	264	215	195	45	SCD701-1300-2-4-137HA15-HP400	31459729
14,00	14,00	280	231	210	45	SCD701-1400-2-4-137HA15-HP400	31459730
15,00	16,00	300	248	225	48	SCD701-1500-2-4-137HA15-HP400	31459731
16,00	16,00	316	264	240	48	SCD701-1600-2-4-137HA15-HP400	31459732

Configurable features



**Diameter:**  
Diameter in increments of 0.01 mm freely selectable



**Specification:**  
SCD701-[diameter]-2-4-137HA15-HP400

**Example:**  
SCD701-0735-2-4-137HA15-HP400

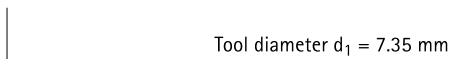

Dimensions in mm.

For cutting data recommendations and coolant specifications, as well as information on the deep hole drilling process, see chapter "Technical Appendix".  
Special designs and other coatings available upon request.

Dimensions of configurable series h7

d <sub>1</sub> min.	d <sub>1</sub> max.	d <sub>2</sub> h6	l <sub>1</sub>	l <sub>2</sub>	l <sub>3</sub>	l <sub>4</sub>
3,00	3,49	4,00	90	58	52	28
3,50	4,00	4,00	98	66	60	28
4,01	4,50	5,00	107	75	68	28
4,51	5,00	5,00	115	83	75	28
5,01	5,50	6,00	131	91	83	36
5,51	6,00	6,00	139	99	90	36
6,01	7,00	8,00	156	116	105	36
7,01	8,00	8,00	172	132	120	36
8,01	9,00	10,00	193	149	135	40
9,01	10,00	10,00	209	165	150	40
10,01	11,00	12,00	231	182	165	45
11,01	12,00	12,00	247	198	180	45
12,01	13,00	14,00	264	215	195	45
13,01	14,00	14,00	280	231	210	45
14,01	15,00	16,00	300	248	225	48
15,01	16,00	16,00	316	264	240	48

# MEGA-Deep-Drill-Steel

Solid carbide twist drill  
SCD701 (20xD), internal coolant supply

**Design:**  
 Drill diameter: 3.00 - 16.00 mm  
 Bore tolerance: IT9 (available)  
 Shank form: HA  
 Cutting material: HP400  
 Number of cutting edges: 2  
 Tip angle: 137°  
 Helix angle: 30°  
 Special features: Head coating

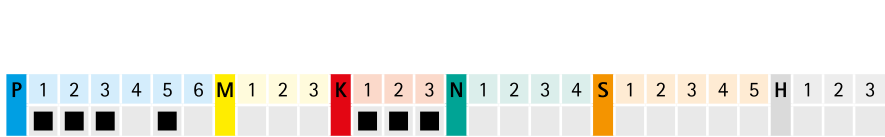
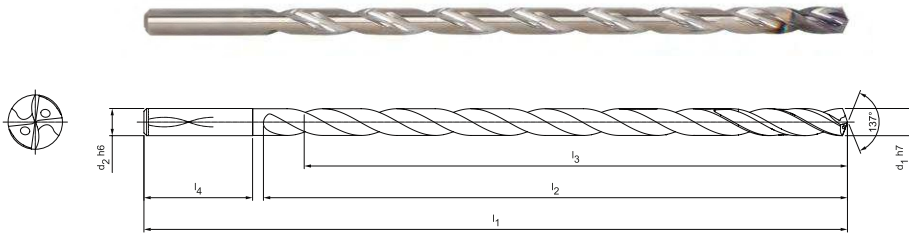

**Preferred series available from stock**

Dimensions						Shank form HA	
d <sub>1</sub> h7	d <sub>2</sub> h6	l <sub>1</sub>	l <sub>2</sub>	l <sub>3</sub>	l <sub>4</sub>	Specification	Order no.
3,00	4,00	108	76	70	28	SCD701-0300-2-4-137HA20-HP400	31459733
3,50	4,00	118	86	80	28	SCD701-0350-2-4-137HA20-HP400	31459734
4,00	4,00	118	86	80	28	SCD701-0400-2-4-137HA20-HP400	31459735
4,50	5,00	129	97	90	28	SCD701-0450-2-4-137HA20-HP400	31459736
5,00	5,00	140	108	100	28	SCD701-0500-2-4-137HA20-HP400	31459737
5,50	6,00	159	119	110	36	SCD701-0550-2-4-137HA20-HP400	31459738
6,00	6,00	169	129	120	36	SCD701-0600-2-4-137HA20-HP400	31459739
6,50	8,00	191	151	140	36	SCD701-0650-2-4-137HA20-HP400	31459740
7,00	8,00	191	151	140	36	SCD701-0700-2-4-137HA20-HP400	31459741
8,00	8,00	212	172	160	36	SCD701-0800-2-4-137HA20-HP400	31459742
9,00	10,00	238	194	180	40	SCD701-0900-2-4-137HA20-HP400	31459743
10,00	10,00	259	215	200	40	SCD701-1000-2-4-137HA20-HP400	31459744
11,00	12,00	286	237	220	45	SCD701-1100-2-4-137HA20-HP400	31459745
12,00	12,00	307	258	240	45	SCD701-1200-2-4-137HA20-HP400	31459746
13,00	14,00	329	280	260	45	SCD701-1300-2-4-137HA20-HP400	31459747
14,00	14,00	350	301	280	45	SCD701-1400-2-4-137HA20-HP400	31459748
15,00	16,00	375	323	300	48	SCD701-1500-2-4-137HA20-HP400	31459749
16,00	16,00	396	344	320	48	SCD701-1600-2-4-137HA20-HP400	31459750

**Configurable features**

**Diameter:**  
Diameter in increments of 0.01 mm freely selectable

**Specification:**  
SCD701-[diameter]-2-4-137HA20-HP400

**Example:**  
SCD701-0735-2-4-137HA20-HP400

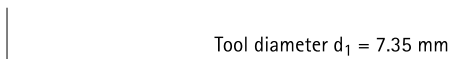

Dimensions in mm.

For cutting data recommendations and coolant specifications, as well as information on the deep hole drilling process, see chapter "Technical Appendix".  
Special designs and other coatings available upon request.

**Dimensions of configurable series h7**

d <sub>1</sub> min.	d <sub>1</sub> max.	d <sub>2</sub> h6	l <sub>1</sub>	l <sub>2</sub>	l <sub>3</sub>	l <sub>4</sub>
3,00	3,49	4,00	108	76	70	28
3,50	4,00	4,00	118	86	80	28
4,01	4,50	5,00	129	97	90	28
4,51	5,00	5,00	140	108	100	28
5,01	5,50	6,00	159	119	110	36
5,51	6,00	6,00	169	129	120	36
6,01	7,00	8,00	191	151	140	36
7,01	8,00	8,00	212	172	160	36
8,01	9,00	10,00	238	194	180	40
9,01	10,00	10,00	259	215	200	40
10,01	11,00	12,00	286	237	220	45
11,01	12,00	12,00	307	258	240	45
12,01	13,00	14,00	329	280	260	45
13,01	14,00	14,00	350	301	280	45
14,01	15,00	16,00	375	323	300	48
15,01	16,00	16,00	396	344	320	48

# MEGA-Deep-Drill-Steel

Solid carbide twist drill  
SCD701 (25xD), internal coolant supply

**Design:**  
 Drill diameter: 3.00 - 14.00 mm  
 Bore tolerance: IT9 (available)  
 Shank form: HA  
 Cutting material: HP400  
 Number of cutting edges: 2  
 Tip angle: 137°  
 Helix angle: 30°  
 Special features: Head coating

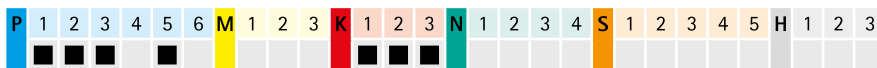
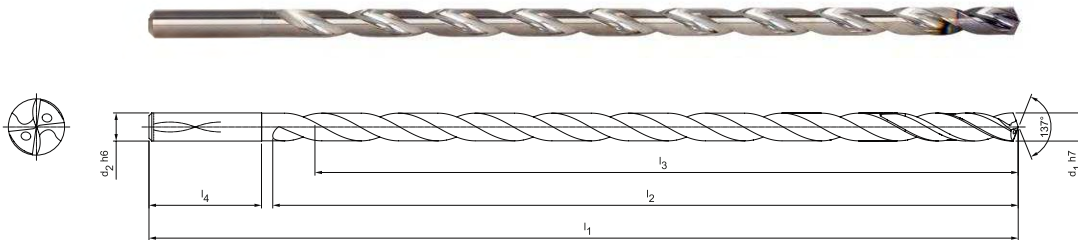

**Preferred series available from stock**

Dimensions						Shank form HA	
d <sub>1</sub> h7	d <sub>2</sub> h6	l <sub>1</sub>	l <sub>2</sub>	l <sub>3</sub>	l <sub>4</sub>	Specification	Order no.
3,00	4,00	125	93	87	28	SCD701-0300-2-4-137HA25-HP400	31459751
3,50	4,00	138	106	100	28	SCD701-0350-2-4-137HA25-HP400	31459752
4,00	4,00	138	106	100	28	SCD701-0400-2-4-137HA25-HP400	31459753
4,50	5,00	152	120	113	28	SCD701-0450-2-4-137HA25-HP400	31459754
5,00	5,00	165	133	125	28	SCD701-0500-2-4-137HA25-HP400	31459755
5,50	6,00	186	146	137	36	SCD701-0550-2-4-137HA25-HP400	31459756
6,00	6,00	199	159	150	36	SCD701-0600-2-4-137HA25-HP400	31459757
7,00	8,00	226	186	175	36	SCD701-0700-2-4-137HA25-HP400	31459758
8,00	8,00	252	212	200	36	SCD701-0800-2-4-137HA25-HP400	31459759
9,00	10,00	283	239	225	40	SCD701-0900-2-4-137HA25-HP400	31459760
10,00	10,00	309	265	250	40	SCD701-1000-2-4-137HA25-HP400	31459761
11,00	12,00	341	292	275	45	SCD701-1100-2-4-137HA25-HP400	31459762
12,00	12,00	367	318	300	45	SCD701-1200-2-4-137HA25-HP400	31459763
13,00	14,00	394	345	325	45	SCD701-1300-2-4-137HA25-HP400	31459764
14,00	14,00	420	371	350	45	SCD701-1400-2-4-137HA25-HP400	31459765

**Configurable features**



**Diameter:**  
Diameter in increments of 0.01 mm freely selectable



**Specification:**  
SCD701-[diameter]-2-4-137HA25-HP400

**Example:**  
SCD701-0735-2-4-137HA25-HP400



Dimensions in mm.  
 For cutting data recommendations and coolant specifications, as well as information on the deep hole drilling process, see chapter "Technical Appendix".  
 Special designs and other coatings available upon request.

**Dimensions of configurable series h7**

d <sub>1</sub> min.	d <sub>1</sub> max.	d <sub>2</sub> h6	l <sub>1</sub>	l <sub>2</sub>	l <sub>3</sub>	l <sub>4</sub>
3,00	3,49	4,00	125	93	87	28
3,50	4,00	4,00	138	106	100	28
4,01	4,50	5,00	152	120	113	28
4,51	5,00	5,00	165	133	125	28
5,01	5,50	6,00	186	146	138	36
5,51	6,00	6,00	199	159	150	36
6,01	7,00	8,00	226	186	175	36
7,01	8,00	8,00	252	212	200	36
8,01	9,00	10,00	283	239	225	40
9,01	10,00	10,00	309	265	250	40
10,01	11,00	12,00	341	292	275	45
11,01	12,00	12,00	367	318	300	45
12,01	13,00	14,00	394	345	325	45
13,01	14,00	14,00	420	371	350	45

# MEGA-Deep-Drill-Steel

Solid carbide twist drill  
SCD701 (30xD), internal coolant supply

**Design:**  
 Drill diameter: 3.00 - 12.00 mm  
 Bore tolerance: IT9 (available)  
 Shank form: HA  
 Cutting material: HP400  
 Number of cutting edges: 2  
 Tip angle: 137°  
 Helix angle: 30°  
 Special features: Head coating

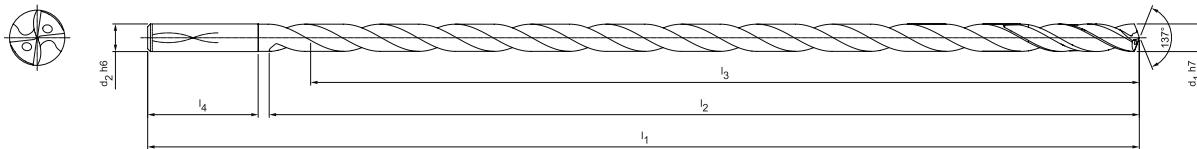

Preferred series available from stock

Dimensions						Shank form HA	
d <sub>1</sub> h7	d <sub>2</sub> h6	l <sub>1</sub>	l <sub>2</sub>	l <sub>3</sub>	l <sub>4</sub>	Specification	Order no.
3,00	4,00	143	111	105	28	SCD701-0300-2-4-137HA30-HP400	31459766
3,50	4,00	158	126	120	28	SCD701-0350-2-4-137HA30-HP400	31459767
4,00	4,00	158	126	120	28	SCD701-0400-2-4-137HA30-HP400	31459768
4,50	5,00	174	142	135	28	SCD701-0450-2-4-137HA30-HP400	31459769
5,00	5,00	190	158	150	28	SCD701-0500-2-4-137HA30-HP400	31459770
5,50	6,00	214	174	165	36	SCD701-0550-2-4-137HA30-HP400	31459771
6,00	6,00	229	189	180	36	SCD701-0600-2-4-137HA30-HP400	31459772
6,50	8,00	261	221	210	36	SCD701-0650-2-4-137HA30-HP400	31459773
7,00	8,00	261	221	210	36	SCD701-0700-2-4-137HA30-HP400	31459774
8,00	8,00	292	252	240	36	SCD701-0800-2-4-137HA30-HP400	31459775
9,00	10,00	328	284	270	40	SCD701-0900-2-4-137HA30-HP400	31459776
10,00	10,00	359	315	300	40	SCD701-1000-2-4-137HA30-HP400	31459777
11,00	12,00	396	347	330	45	SCD701-1100-2-4-137HA30-HP400	31459778
12,00	12,00	427	378	360	45	SCD701-1200-2-4-137HA30-HP400	31459779

Configurable features

**Diameter:**  
Diameter in increments of 0.01 mm freely selectable

**Specification:**  
SCD701-[diameter]-2-4-137HA30-HP400

**Example:**  
SCD701-0735-2-4-137HA30-HP400



Dimensions of configurable series h7

d <sub>1</sub> min.	d <sub>1</sub> max.	d <sub>2</sub> h6	l <sub>1</sub>	l <sub>2</sub>	l <sub>3</sub>	l <sub>4</sub>
3,00	3,49	4,00	143	111	105	28
3,50	4,00	4,00	158	126	120	28
4,01	4,50	5,00	174	142	135	28
4,51	5,00	5,00	190	158	150	28
5,01	5,50	6,00	214	174	165	36
5,51	6,00	6,00	229	189	180	36
6,01	7,00	8,00	261	221	210	36
7,01	8,00	8,00	292	252	240	36
8,01	9,00	10,00	328	284	270	40
9,01	10,00	10,00	359	315	300	40
10,01	11,00	12,00	396	347	330	45
11,01	12,00	12,00	427	378	360	45

Dimensions in mm.

For cutting data recommendations and coolant specifications, as well as information on the deep hole drilling process, see chapter "Technical Appendix".  
Special designs and other coatings available upon request.

# MEGA-Deep-Drill-Steel

Solid carbide twist drill  
SCD701 (40xD), internal coolant supply

**Design:**  
 Drill diameter: 3.00 - 9.00 mm  
 Bore tolerance: IT9 (available)  
 Shank form: HA  
 Cutting material: HP400  
 Number of cutting edges: 2  
 Tip angle: 134°  
 Helix angle: 30°  
 Special features: Head coating

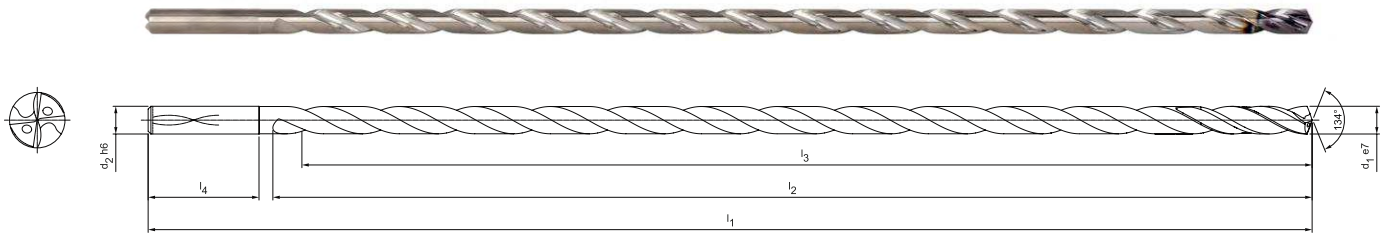

P
1
2
3
4
5
6
M
1
2
3
K
1
2
3
N
1
2
3
4
S
1
2
3
4
5
H
1
2
3

**Preferred series available from stock**

Dimensions						Shank form HA	
d <sub>1</sub> e7	d <sub>2</sub> h6	l <sub>1</sub>	l <sub>2</sub>	l <sub>3</sub>	l <sub>4</sub>	Specification	Order no.
3,00	4,00	178	146	140	28	SCD701-0300-2-4-134HA40-HP400	31459780
3,50	4,00	198	166	160	28	SCD701-0350-2-4-134HA40-HP400	31459781
4,00	4,00	198	166	160	28	SCD701-0400-2-4-134HA40-HP400	31459782
4,50	5,00	219	187	180	28	SCD701-0450-2-4-134HA40-HP400	31459783
5,00	5,00	240	208	200	28	SCD701-0500-2-4-134HA40-HP400	31459784
6,00	6,00	289	249	240	36	SCD701-0600-2-4-134HA40-HP400	31459785
7,00	8,00	331	291	280	36	SCD701-0700-2-4-134HA40-HP400	31459786
8,00	8,00	372	332	320	36	SCD701-0800-2-4-134HA40-HP400	31459787
9,00	10,00	418	374	360	40	SCD701-0900-2-4-134HA40-HP400	31459788

**Configurable features**

**Diameter:**  
Diameter in increments of 0.01 mm freely selectable

**Specification:**  
SCD701-[Diameter]-2-4-134HA40-HP400

**Example:**  
SCD701-0735-2-4-134HA40-HP400

Tool diameter d<sub>1</sub> = 7.35 mm

**Dimensions of configurable series e7**

d <sub>1</sub> min.	d <sub>1</sub> max.	d <sub>2</sub> h6	l <sub>1</sub>	l <sub>2</sub>	l <sub>3</sub>	l <sub>4</sub>
3,00	3,49	4,00	178	146	140	28
3,50	4,00	4,00	198	166	160	28
4,01	4,50	5,00	219	187	180	28
4,51	5,00	5,00	240	208	200	28
5,01	5,50	6,00	269	229	220	36
5,51	6,00	6,00	289	249	240	36
6,01	7,00	8,00	331	291	280	36
7,01	8,00	8,00	372	332	320	36
8,01	9,00	10,00	418	374	360	40

Dimensions in mm.  
 For cutting data recommendations and coolant specifications, as well as information on the deep hole drilling process, see chapter "Technical Appendix".  
 Special designs and other coatings available upon request.





# Reamer | Selection system

Design	Recommended diameter range [mm]	Tolerance	Series			Product category		
			Series	Diameter	Series			
	3,000 - 14,000	≥ IT6	FixReam 500		Solid carbide reamer for a wide range of applications. Depending on the diameter, the FixReam high-performance reamers have between four and eight cutting edges with internal cooling and achieve correspondingly high feed rates.	2,800 - 20,200*	FXR510	Performance LINE
						2,800 - 20,200*	FXR505	
						3,701 - 20,200*	FXR500	
						2,800 - 20,100*	FXR503	
			FixReam 500 Plus <span style="color: green;">N</span>		The new FixReam 500 Plus is suitable for blind and through bores and impresses with cost efficiency and high productivity. An improved arc land chamfer ensures more precise holes and optimises roundness.	3,701 - 20,200	FXR507	
9,900 - 32,000	≥ IT6	FixReam 700 <span style="color: green;">N</span>		The FixReam 700 was developed to increase economic efficiency through efficient reconditioning. Thanks to an expansion screw, the diameter of the multi-bladed reamer can be extended prior to regrinding. This makes it possible to regrind all functional surfaces, both on the lead, and also on the tool diameter. As a result, the reamer can be reused up to nine times.	9,900 - 32,200*	FXR700	Performance LINE	
					FXR702			
					FXR703			
					FXR705			
4,000 - 8,000	≥ IT6	MonoReam Plus		Especially for machining cast iron and steel. A sleeve ensures the optimal supply of coolant to the HPC blades.	3,850 - 8,200	MRP505	Performance LINE	
					MRP510			
1,000 - 13,000	≥ IT7	NC machine reamer <span style="color: blue;">+</span>		MAPAL provides solid carbide machine reamers with consistently high raw material quality. With small to medium lot sizes or on older machines without internal coolant supply, the benefits of the high-performance reamers' high cutting data are not realised. In such scenarios, cost-effective DIN reamers are a more efficient alternative.	1,000 - 13,000	MDR500	Basic LINE	
					MDR510			
	7,000 - 65,000	≥ IT5	HPR		High-precision replaceable head system in fixed and fine-adjustable design.	7,000 - 65,000	HPR1XX   fixed	Performance LINE
						HPR2XX   finely adjustable	Expert LINE	
	63,000 - 319,999	≥ IT7	HPR 400   400 Plus		Exchangeable cutting edges make it easy to replace the cutting edge on site. This results in very short set-up times.	63,000 - 319,999	HPR400   400 Plus	Expert LINE

■ highly suitable

▣ suitable in some situations

\* The diameter range can vary, depending on the series.



Step 1:  
Design



Step 2:  
Bore features



Step 3:  
Product category



Step 4:  
Material suitability



Step 5:  
Type of bore



	Material suitability																Type of bore		Product		Catalogue														
	P						M	K					N		S			H		CONFIG	Configurable diameter range	Main catalogue	Page												
	1	2	3.1	3.2	3.3	4	5	6	1-3	1	2.1	2.2	2.3	3	1-2	N3	1.1	1.2	1.3					1-5	1	2									
	■	■	■	■	■	■	■	■	■	■	■	■	■	■	■		■	■	■	■		■													
	■	■	■	■	■	■	■	■	■	■	■	■	■	■	■		■	■	■	■	■	■		■		■		✓			✓				
	■	■	■	■	■	■	■	■	■	■	■	■	■	■	■									■		■		✓							34
	■	■	■	■	■			■	■	■	■	■	■	■										■				✓							40
	■	■	■	■				■	■	■														■		■		✓			✓				
	■	■	■	■	■	■	■	■	■	■	■	■	■	■	■									■				-							45
	■	■	■	■	■	■	■	■	■	■	■	■	■	■	■									■				-							46
	■	■	■	■	■	■	■	■	■	■	■	■	■	■	■									■	■			✓			✓				
	■	■	■	■	■	■	■	■	■	■	■	■	■	■	■									■	■			✓			✓				

# FixReam 500 Plus

## FixReam 507, cost-efficient and productive for blind and through bores

New carbide substrates geared specifically to machining operations in combination with new coatings result in longer tool lives. A new arc land chamfer allows the reamers to enter the bore more precisely. As a result, roundness and cylindrical forms are further improved.

### 1 High-performance coating

- For machining **P M K N S H**

### 2 Patented arc land chamfer

- For up to 30% better roundness and cylindrical form

### 3 Prime number spacing

- Less vibrations, better surfaces, smoother running and longer tool life

### 4 Innovative coolant outlets

- Optimal cooling lubricant supply at the blind and through bores

### Universal application

Design for the machining of blind and through bores for reducing the storage costs

### Short design

for more stability and higher feed rates

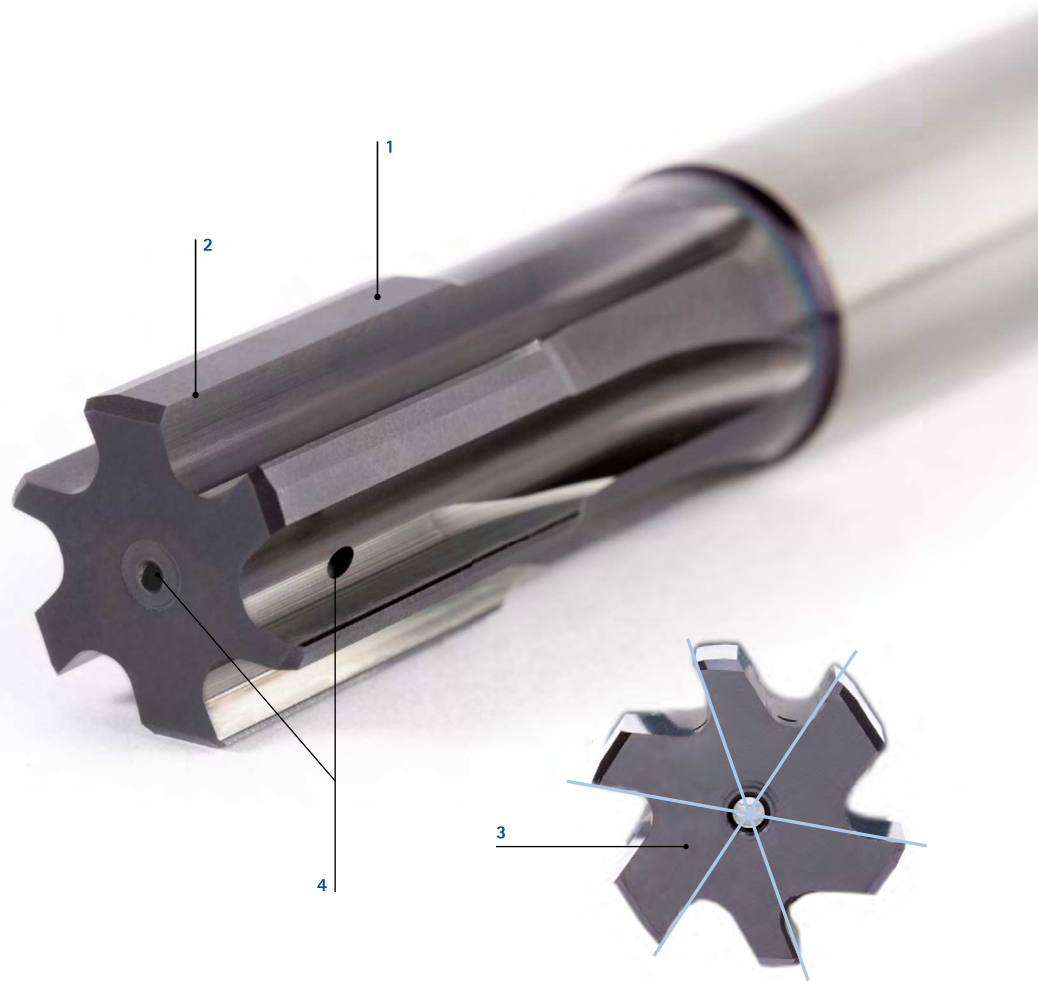

## Features

- A reamer for through and blind bores
- Up to 100% increase in tool life
- Lower storage costs, due to universal application
- Short design increases the stability and saves carbide resources
- In the diameter range from 3.701 to 20.200 mm
- Perfectly adapted to almost all workpiece materials
- Patented arc land chamfer

## Achieved tool life [%]

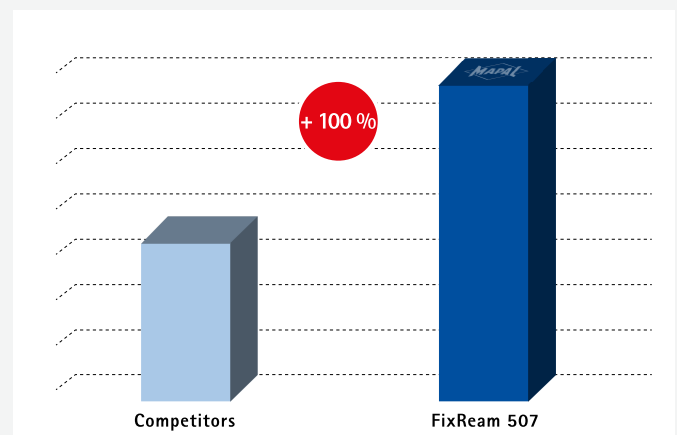

# FixReam 500 Plus

Fixed design, straight fluted, for blind and through bores  
FXR507, internal coolant supply

**Design:**

Reamer diameter: 3.701 - 20.200 mm  
Lead: MJ1G  
Cutting material: HP900 Carbide  
PVD-coated

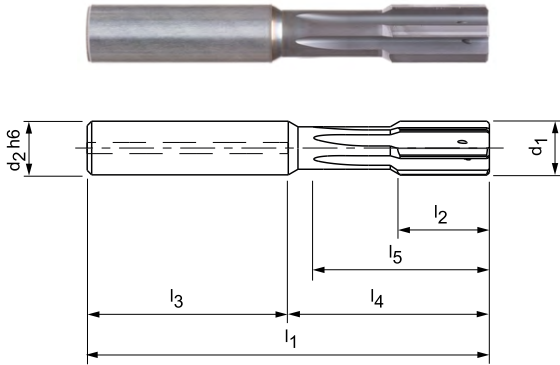

Preferred series available from stock in H7 | +0.005

Dimensions								z	Specification	Order no.
d1	Tolerance	d2h6	l1	l2	l3	l4	l5			
3,970	+0,005	4	50	12	28	22	19	4	FXR507G03.970+5MJ1G-HP900	31375070
3,980	+0,005	4	50	12	28	22	19	4	FXR507G03.980+5MJ1G-HP900	31375126
3,990	+0,005	4	50	12	28	22	19	4	FXR507G03.990+5MJ1G-HP900	31375128
4,000	H7	4	50	12	28	22	19	4	FXR50704.000H7MJ1G-HP900	31375127
4,010	+0,005	4	50	12	28	22	19	4	FXR507G04.010+5MJ1G-HP900	31375129
4,020	+0,005	4	50	12	28	22	19	4	FXR507G04.020+5MJ1G-HP900	31375105
4,030	+0,005	4	50	12	28	22	19	4	FXR507G04.030+5MJ1G-HP900	31375106
4,970	+0,005	4	50	12	28	22	19	4	FXR507G04.970+5MJ1G-HP900	31375135
4,980	+0,005	4	50	12	28	22	19	4	FXR507G04.980+5MJ1G-HP900	31375108
4,990	+0,005	4	50	12	28	22	19	4	FXR507G04.990+5MJ1G-HP900	31375136
5,000	H7	4	50	12	28	22	19	4	FXR50705.000H7MJ1G-HP900	31375109
5,010	+0,005	4	50	12	28	22	19	4	FXR507G05.010+5MJ1G-HP900	31375241
5,020	+0,005	4	50	12	28	22	19	4	FXR507G05.020+5MJ1G-HP900	31375242
5,030	+0,005	4	50	12	28	22	19	4	FXR507G05.030+5MJ1G-HP900	31375736
5,970	+0,005	6	64	12	36	28	25	6	FXR507G05.970+5MJ1G-HP900	31375273
5,980	+0,005	6	64	12	36	28	25	6	FXR507G05.980+5MJ1G-HP900	31375275
5,990	+0,005	6	64	12	36	28	25	6	FXR507G05.990+5MJ1G-HP900	31375277
6,000	H7	6	64	12	36	28	25	6	FXR50706.000H7MJ1G-HP900	31375274
6,010	+0,005	6	64	12	36	28	25	6	FXR507G06.010+5MJ1G-HP900	31375276
6,020	+0,005	6	64	12	36	28	25	6	FXR507G06.020+5MJ1G-HP900	31375278
6,030	+0,005	6	64	12	36	28	25	6	FXR507G06.030+5MJ1G-HP900	31375279
7,000	H7	6	70	16	36	34	31	6	FXR50707.000H7MJ1G-HP900	31375291
7,970	+0,005	8	75	16	36	39	36	6	FXR507G07.970+5MJ1G-HP900	31375295
7,980	+0,005	8	75	16	36	39	36	6	FXR507G07.980+5MJ1G-HP900	31375297
7,990	+0,005	8	75	16	36	39	36	6	FXR507G07.990+5MJ1G-HP900	31375299
8,000	H7	8	75	16	36	39	36	6	FXR50708.000H7MJ1G-HP900	31375301
8,010	+0,005	8	75	16	36	39	36	6	FXR507G08.010+5MJ1G-HP900	31375303
8,020	+0,005	8	75	16	36	39	36	6	FXR507G08.020+5MJ1G-HP900	31375306
8,030	+0,005	8	75	16	36	39	36	6	FXR507G08.030+5MJ1G-HP900	31375308
9,000	H7	8	80	20	36	44	41	6	FXR50709.000H7MJ1G-HP900	31375311
9,970	+0,005	10	80	20	40	40	37	6	FXR507G09.970+5MJ1G-HP900	31375314
9,980	+0,005	10	80	20	40	40	37	6	FXR507G09.980+5MJ1G-HP900	31375315
9,990	+0,005	10	80	20	40	40	37	6	FXR507G09.990+5MJ1G-HP900	31375317
10,000	H7	10	80	20	40	40	37	6	FXR507010.000H7MJ1G-HP900	31375319
10,010	+0,005	10	80	20	40	40	37	6	FXR507G010.010+5MJ1G-HP900	31375322

Continued on next page.

## FixReam 500 Plus | FXR507, fixed design, straight fluted, for blind and through bores

Dimensions								z	Specification	Order no.
d1	Tolerance	d2h6	l1	l2	l3	l4	l5			
10,020	+0,005	10	80	20	40	40	37	6	FXR507GØ10.020+5MJ1G-HP900	31375325
10,030	+0,005	10	80	20	40	40	37	6	FXR507GØ10.030+5MJ1G-HP900	31375328
11,000	H7	10	85	20	40	45	42	6	FXR507Ø11.000H7MJ1G-HP900	31375333
11,970	+0,005	12	90	20	45	45	42	6	FXR507GØ11.970+5MJ1G-HP900	31375342
11,980	+0,005	12	90	20	45	45	42	6	FXR507GØ11.980+5MJ1G-HP900	31375345
11,990	+0,005	12	90	20	45	45	42	6	FXR507GØ11.990+5MJ1G-HP900	31375349
12,000	H7	12	90	20	45	45	42	6	FXR507Ø12.000H7MJ1G-HP900	31375351
12,010	+0,005	12	90	20	45	45	42	6	FXR507GØ12.010+5MJ1G-HP900	31375354
12,020	+0,005	12	90	20	45	45	42	6	FXR507GØ12.020+5MJ1G-HP900	31375357
12,030	+0,005	12	90	20	45	45	42	6	FXR507GØ12.030+5MJ1G-HP900	31375359
13,000	H7	12	90	22	45	45	42	6	FXR507Ø13.000H7MJ1G-HP900	31375371
14,000	H7	14	95	22	45	50	47	6	FXR507Ø14.000H7MJ1G-HP900	31375376
15,000	H7	14	100	22	45	55	52	6	FXR507Ø15.000H7MJ1G-HP900	31375378
16,000	H7	16	105	25	48	57	54	6	FXR507Ø16.000H7MJ1G-HP900	31375380
17,000	H7	16	110	25	48	62	59	6	FXR507Ø17.000H7MJ1G-HP900	31375381
18,000	H7	18	110	25	48	62	59	6	FXR507Ø18.000H7MJ1G-HP900	31375384
19,000	H7	18	110	25	48	62	59	6	FXR507Ø19.000H7MJ1G-HP900	31375386
20,000	H7	20	115	25	50	65	62	6	FXR507Ø20.000H7MJ1G-HP900	31375388

## Configurable features

**Bore diameter tolerance ≥ IT6:**

- Diameter in increments of 0.001 mm freely selectable

**Specification:**

FXR507Ø[Diameter][Tolerance]MJ1G-HP900

**G variant** (see cutting data):

- Diameter in increments of 0.001 mm freely selectable
- Can be ordered from tolerances ≥ 5 µm

**G variant specification:**

FXR507GØ[Diameter][Tolerance]MJ1G-HP900

**IT8 tolerance example:**

FXR507Ø11.530H8MJ1G-HP900

Bore diameter d1 = 11.530 H8

**G variant example:**

FXR507GØ11.530+5MJ1G-HP900

Special tool diameter d1 = 11.530 +5 µm

## Dimensions of configurable series IT6

d1	d2h6	l1	l2	l3	l4	l5	z
3,701 - 5,200	4	50	12	28	22	19	4
5,201 - 5,700	6	64	12	36	28	25	4
5,701 - 6,200	6	64	12	36	28	25	6
6,201 - 7,700	6	70	16	36	34	31	6
7,701 - 8,200	8	75	16	36	39	36	6
8,201 - 8,700	8	75	20	36	39	36	6
8,701 - 9,700	8	80	20	36	44	41	6
9,701 - 10,700	10	80	20	40	40	37	6
10,701 - 11,700	10	85	20	40	45	42	6
11,701 - 12,200	12	90	20	45	45	42	6
12,201 - 13,200	12	90	22	45	45	42	6
13,201 - 14,200	14	95	22	45	50	47	6
14,201 - 15,200	14	100	22	45	55	52	6
15,201 - 16,200	16	105	25	48	57	54	6
16,201 - 17,200	16	110	25	48	62	59	6
17,201 - 19,200	18	110	25	48	62	59	6
19,201 - 20,200	20	115	25	50	65	62	6

# FixReam 500 Plus

Fixed design, straight fluted, for blind and through bores  
 FXR507, internal coolant supply

**Design:**

Reamer diameter: 3.701 - 20.200 mm  
 Lead: MM1G  
 Cutting material: HP900  
 Carbide  
 PVD-coated

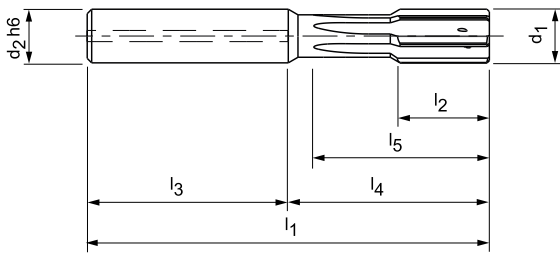

**Configurable features**



**Bore diameter tolerance ≥ IT6:**

- Diameter in increments of 0.001 mm freely selectable

**Specification:**

FXR507Ø[**Diameter**][**Tolerance**]MM1G-HP900

**G variant (see cutting data):**

- Diameter in increments of 0.001 mm freely selectable  
 - Can be ordered from tolerances ≥ 5 µm

**G variant specification:**

FXR507GØ[**Diameter**][**Tolerance**]MM1G-HP900

**IT8 tolerance example:**

FXR507Ø11.530H8MM1G-HP900

Bore diameter d1 = 11.530 H8

**G variant example:**

FXR507GØ11.530+5MM1G-HP900

Special tool diameter d1 = 11.530 +5 µm

**Dimensions of configurable series IT6**

d <sub>1</sub>	d <sub>2</sub> h6	l <sub>1</sub>	l <sub>2</sub>	l <sub>3</sub>	l <sub>4</sub>	l <sub>5</sub>	z
3,701 - 5,200	4	50	12	28	22	19	4
5,201 - 5,700	6	64	12	36	28	25	4
5,701 - 6,200	6	64	12	36	28	25	6
6,201 - 7,700	6	70	16	36	34	31	6
7,701 - 8,200	8	75	16	36	39	36	6
8,201 - 8,700	8	75	20	36	39	36	6
8,701 - 9,700	8	80	20	36	44	41	6
9,701 - 10,700	10	80	20	40	40	37	6
10,701 - 11,700	10	85	20	40	45	42	6
11,701 - 12,200	12	90	20	45	45	42	6
12,201 - 13,200	12	90	22	45	45	42	6
13,201 - 14,200	14	95	22	45	50	47	6
14,201 - 15,200	14	100	22	45	55	52	6
15,201 - 16,200	16	105	25	48	57	54	6
16,201 - 17,200	16	110	25	48	62	59	6
17,201 - 19,200	18	110	25	48	62	59	6
19,201 - 20,200	20	115	25	50	65	62	6

Dimensions in mm.

For cutting data recommendations, see chapter "Technical Appendix".

# FixReam 500 Plus

Fixed design, straight fluted, for blind and through bores  
FXR507, internal coolant supply

**Design:**

Reamer diameter: 3.701 - 20.200 mm  
Lead: MQ1G  
Cutting material: HP622  
Carbide  
PVD-coated

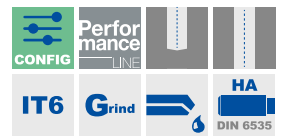
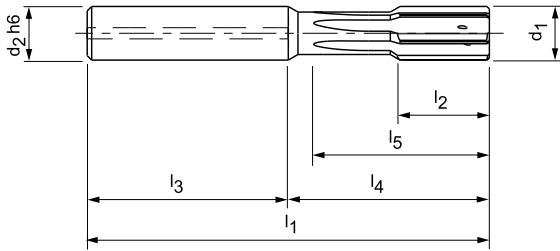

**Configurable features**



**Bore diameter tolerance ≥ IT6:**  
- Diameter in increments of 0.001 mm freely selectable

**Specification:**  
FXR507Ø[**Diameter**][**Tolerance**]MQ1G-HP622

**G variant** (see cutting data):  
- Diameter in increments of 0.001 mm freely selectable  
- Can be ordered from tolerances ≥ 4 µm

**G variant specification:**  
FXR507GØ[**Diameter**][**Tolerance**]MQ1G-HP622

**IT8 tolerance example:**  
FXR507Ø11.530H8MQ1G-HP622

Bore diameter d1 = 11.530 H8

**G variant example:**  
FXR507GØ11.530+5MQ1G-HP622

Special tool diameter d1 = 11.530 +4 µm

**Dimensions of configurable series IT6**

d <sub>1</sub>	d <sub>2</sub> h6	l <sub>1</sub>	l <sub>2</sub>	l <sub>3</sub>	l <sub>4</sub>	l <sub>5</sub>	z
3,701 - 5,200	4	50	12	28	22	19	4
5,201 - 5,700	6	64	12	36	28	25	4
5,701 - 6,200	6	64	12	36	28	25	6
6,201 - 7,700	6	70	16	36	34	31	6
7,701 - 8,200	8	75	16	36	39	36	6
8,201 - 8,700	8	75	20	36	39	36	6
8,701 - 9,700	8	80	20	36	44	41	6
9,701 - 10,700	10	80	20	40	40	37	6
10,701 - 11,700	10	85	20	40	45	42	6
11,701 - 12,200	12	90	20	45	45	42	6
12,201 - 13,200	12	90	22	45	45	42	6
13,201 - 14,200	14	95	22	45	50	47	6
14,201 - 15,200	14	100	22	45	55	52	6
15,201 - 16,200	16	105	25	48	57	54	6
16,201 - 17,200	16	110	25	48	62	59	6
17,201 - 19,200	18	110	25	48	62	59	6
19,201 - 20,200	20	115	25	50	65	62	6

Dimensions in mm.  
For cutting data recommendations, see chapter "Technical Appendix".

# FixReam 500 Plus

Fixed design, straight fluted, for blind and through bores  
FXR507, internal coolant supply

**Design:**

Reamer diameter: 3.701 - 20.200 mm  
Lead: MM1G  
Cutting material: HP141  
Carbide  
PVD-coated

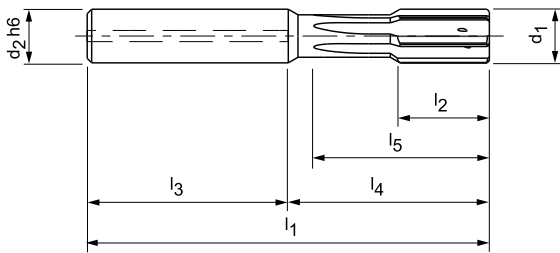

**Configurable features**



**Bore diameter tolerance ≥ IT6:**

- Diameter in increments of 0.001 mm freely selectable

**Specification:**

FXR507Ø[**Diameter**][**Tolerance**]MM1G-HP141

**G variant (see cutting data):**

- Diameter in increments of 0.001 mm freely selectable  
- Can be ordered from tolerances ≥ 5 µm

**G variant specification:**

FXR507GØ[**Diameter**][**Tolerance**]MM1G-HP141

**IT8 tolerance example:**

FXR507Ø11.530H8MM1G-HP141

Bore diameter d1 = 11.530 H8

**G variant example:**

FXR507GØ11.530+5MM1G-HP141

Special tool diameter d1 = 11.530 +5 µm

**Dimensions of configurable series IT6**

d <sub>1</sub>	d <sub>2</sub> h6	l <sub>1</sub>	l <sub>2</sub>	l <sub>3</sub>	l <sub>4</sub>	l <sub>5</sub>	z
3,701 - 5,200	4	50	12	28	22	19	4
5,201 - 5,700	6	64	12	36	28	25	4
5,701 - 6,200	6	64	12	36	28	25	6
6,201 - 7,700	6	70	16	36	34	31	6
7,701 - 8,200	8	75	16	36	39	36	6
8,201 - 8,700	8	75	20	36	39	36	6
8,701 - 9,700	8	80	20	36	44	41	6
9,701 - 10,700	10	80	20	40	40	37	6
10,701 - 11,700	10	85	20	40	45	42	6
11,701 - 12,200	12	90	20	45	45	42	6
12,201 - 13,200	12	90	22	45	45	42	6
13,201 - 14,200	14	95	22	45	50	47	6
14,201 - 15,200	14	100	22	45	55	52	6
15,201 - 16,200	16	105	25	48	57	54	6
16,201 - 17,200	16	110	25	48	62	59	6
17,201 - 19,200	18	110	25	48	62	59	6
19,201 - 20,200	20	115	25	50	65	62	6

Dimensions in mm.

For cutting data recommendations, see chapter "Technical Appendix".

# FixReam 700

## Significantly reduced cost per part thanks to reconditioning

The FixReam 700 was developed to increase economic efficiency through efficient reconditioning. Thanks to an expansion screw, the diameter of the multi-bladed reamer can be extended prior to regrinding. This makes it possible to regrind all functional surfaces, both on the lead, and also on the tool diameter. As a result, the reamer can be reused up to nine times.

### 1 30% better roundness and cylindrical form

- Due to patented geometry

### 2 Optimum chip formation

- New, innovative leads enable improved chip formation

### 3 Up to 9 tool inserts

- Thanks to expansion screw for compensation prior to regrinding



## Features

### Configurable features:

- Ø area: 9.900 - 32.200 mm
- Bore diameter: Tolerance  $\geq$  IT6
- Tool diameter: Tolerance  $\geq$  3  $\mu$ m at a graduation of 0.001 mm
- Additional carbide-coated and Cermet-coated variants will follow in Q2 2024

### Dimensions:

- Available as a short and long design
- For through bores and blind bores
- Preferred series in H7 available from stock: 10.000 - 32.000 mm

## Achieved tool life [%]

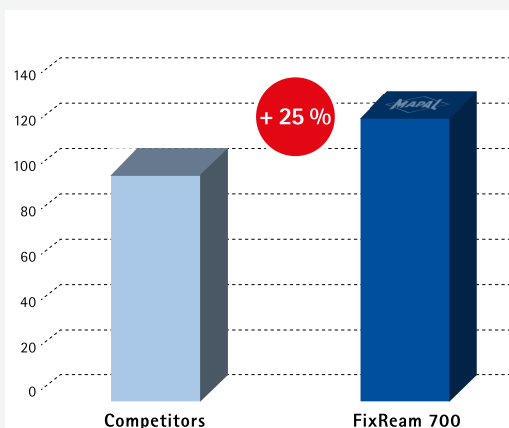

### Workpiece material: 42CrMoS4

Machining length: 45.00 mm  
 Nominal Ø: 12.00 mm  
 n: 3448 rpm  
 v<sub>f</sub>: 3448 mm/min  
 v<sub>c</sub>: 130 m/min  
 z: 6



# FixReam 700

Expanding design, short, for through bore  
FXR702

**Design:**

Reamer diameter: 9.900 - 32.200 mm  
Lead: LA1G  
Cutting material: CU111  
Uncoated cermet

**Application:**

The expansion system is therefore only suitable for compensation prior to re-grinding and not for setting or re-adjusting the diameter.

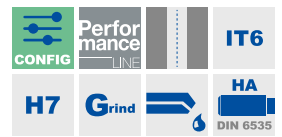
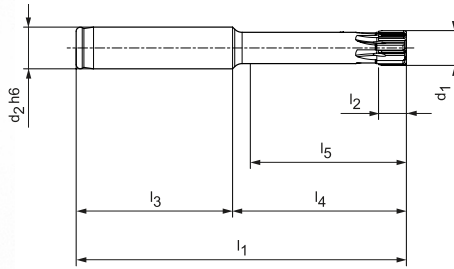

**Preferred series in H7**

d <sub>1</sub> H7	Dimensions						z	Specification	Order no.
	d <sub>2</sub> h6	l <sub>1</sub>	l <sub>2</sub>	l <sub>3</sub>	l <sub>4</sub>	l <sub>5</sub>			
10,000	12	95	8	45	50	45	6	FXR702Ø10.000H7LA1G-CU111	31460929
12,000	12	95	8	45	50	45	6	FXR702Ø12.000H7LA1G-CU111	31460960
14,000	12	95	8	45	50	45	6	FXR702Ø14.000H7LA1G-CU111	31460961
16,000	16	100	12	50	50	45	6	FXR702Ø16.000H7LA1G-CU111	31460962
18,000	16	100	12	50	50	45	6	FXR702Ø18.000H7LA1G-CU111	31460963
20,000	20	120	12	60	60	55	6	FXR702Ø20.000H7LA1G-CU111	31460964
22,000	20	120	12	60	60	55	6	FXR702Ø22.000H7LA1G-CU111	31460965
24,000	20	120	12	60	60	55	6	FXR702Ø24.000H7LA1G-CU111	31460966
25,000	20	120	12	60	60	55	6	FXR702Ø25.000H7LA1G-CU111	31460967
28,000	25	135	12	60	75	70	6	FXR702Ø28.000H7LA1G-CU111	31460968
30,000	25	135	12	60	75	70	6	FXR702Ø30.000H7LA1G-CU111	31460969
32,000	25	135	12	60	75	70	6	FXR702Ø32.000H7LA1G-CU111	31460970

**Configurable features**



**Bore diameter tolerance ≥ IT6:**  
- Diameter in increments of 0.001 mm freely selectable  
- Can be ordered in tolerance ≥ IT6

**Specification:**  
FXR702Ø[**Diameter**][**Tolerance**]LA1G-CU111

**G variants:**  
- Diameter in increments of 0.001 mm freely selectable  
- Can be ordered from tolerances ≥ 3 µm (G variant, see cutting data)

**G variant specification:**  
FXR702GØ[**Diameter**][**Tolerance**]LA1G-CU111

**Dimensions of configurable series IT6**

d <sub>1</sub>	d <sub>2</sub>	l <sub>1</sub>	l <sub>2</sub>	l <sub>3</sub>	l <sub>4</sub>	l <sub>5</sub>	z
9,900 - 15,899	12	95	8	45	50	45	6
15,900 - 18,899	16	100	12	50	50	45	6
18,900 - 25,899	20	120	12	60	60	55	6
25,900 - 32,200	25	135	12	60	75	70	6

**IT6 tolerance example:**  
FXR702Ø16,350H6LA1G-CU111

Bore diameter d<sub>1</sub> = 16.350 H6

**G variant example:**  
FXR702GØ16,350-3LA1G-CU111

Special tool diameter d<sub>1</sub> = 16.350 -3 µm

Dimensions in mm.  
For cutting data recommendations, see chapter "Technical Appendix".

# FixReam 700

Expanding design, long, for through bore  
FXR700

**Design:**

Reamer diameter: 9.900 - 32.200 mm  
Lead: LA1G  
Cutting material: CU111  
Uncoated cermet

**Application:**

The expansion system is therefore only suitable for compensation prior to re-grinding and not for setting or re-adjusting the diameter.

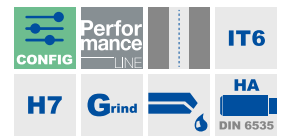
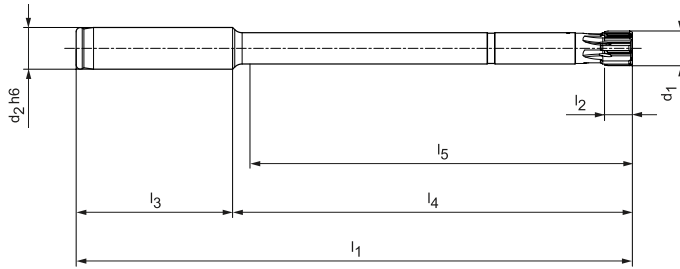

**Preferred series in H7**

d <sub>1</sub> H7	Dimensions						z	Specification	Order no.
	d <sub>2</sub> h6	l <sub>1</sub>	l <sub>2</sub>	l <sub>3</sub>	l <sub>4</sub>	l <sub>5</sub>			
10,000	12	160	8	45	115	110	6	FXR700Ø10.000H7LA1G-CU111	31460971
12,000	12	160	8	45	115	110	6	FXR700Ø12.000H7LA1G-CU111	31460972
14,000	12	160	8	45	115	110	6	FXR700Ø14.000H7LA1G-CU111	31460973
16,000	16	180	12	50	130	125	6	FXR700Ø16.000H7LA1G-CU111	31460974
18,000	16	180	12	50	130	125	6	FXR700Ø18.000H7LA1G-CU111	31460975
20,000	20	200	12	60	140	135	6	FXR700Ø20.000H7LA1G-CU111	31460976
22,000	20	200	12	60	140	135	6	FXR700Ø22.000H7LA1G-CU111	31460977
24,000	20	200	12	60	140	135	6	FXR700Ø24.000H7LA1G-CU111	31460978
25,000	20	200	12	60	140	135	6	FXR700Ø25.000H7LA1G-CU111	31460979
28,000	25	210	12	60	150	145	6	FXR700Ø28.000H7LA1G-CU111	31460980
30,000	25	210	12	60	150	145	6	FXR700Ø30.000H7LA1G-CU111	31460981
32,000	25	210	12	60	150	145	6	FXR700Ø32.000H7LA1G-CU111	31460982

**Configurable features**



**Bore diameter tolerance ≥ IT6:**  
- Diameter in increments of 0.001 mm freely selectable  
- Can be ordered in tolerance ≥ IT6

**Specification:**  
FXR700Ø[**Diameter**][**Tolerance**]LA1G-CU111

**G variants:**  
- Diameter in increments of 0.001 mm freely selectable  
- Can be ordered from tolerances ≥ 3 µm (G variant, see cutting data)

**G variant specification:**  
FXR700GØ[**Diameter**][**Tolerance**]LA1G-CU111

**Dimensions of configurable series IT6**

d <sub>1</sub>	d <sub>2</sub>	l <sub>1</sub>	l <sub>2</sub>	l <sub>3</sub>	l <sub>4</sub>	l <sub>5</sub>	z
9,900 - 15,899	12	160	8	45	115	110	6
15,900 - 18,899	16	180	12	50	130	125	6
18,900 - 25,899	20	200	12	60	140	135	6
25,900 - 32,200	25	210	12	60	150	145	6

**IT6 tolerance example:**  
FXR700Ø16,350H6LA1G-CU111

Bore diameter d<sub>1</sub> = 16.350 H6

**G variant example:**  
FXR700GØ16,350-3LA1G-CU111

Special tool diameter d<sub>1</sub> = 16.350 -3 µm

Dimensions in mm.  
For cutting data recommendations, see chapter "Technical Appendix".

# FixReam 700

Expanding design, short, for blind bore  
FXR703

**Design:**

Reamer diameter: 9.900 - 32.200 mm  
Lead: LB1G  
Cutting material: CU111  
Uncoated cermet

**Application:**

The expansion system is therefore only suitable for compensation prior to re-grinding and not for setting or re-adjusting the diameter.

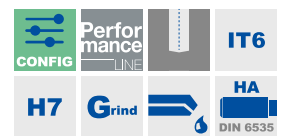
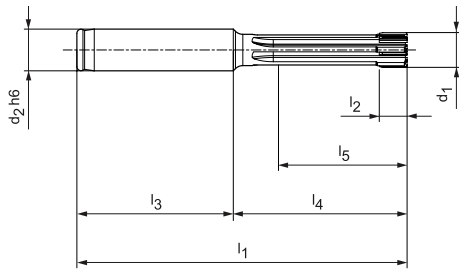

**Preferred series in H7**

d <sub>1</sub> H7	Dimensions						z	Specification	Order no.
	d <sub>2</sub> h6	l <sub>1</sub>	l <sub>2</sub>	l <sub>3</sub>	l <sub>4</sub>	l <sub>5</sub>			
10,000	12	95	8	45	50	38	6	FXR703Ø10.000H7LB1G-CU111	31460983
12,000	12	95	8	45	50	39	6	FXR703Ø12.000H7LB1G-CU111	31460984
14,000	12	95	8	45	50	39	6	FXR703Ø14.000H7LB1G-CU111	31460985
16,000	16	100	12	50	50	38	6	FXR703Ø16.000H7LB1G-CU111	31460986
18,000	16	100	12	50	50	39	6	FXR703Ø18.000H7LB1G-CU111	31460987
20,000	20	120	12	60	60	45	6	FXR703Ø20.000H7LB1G-CU111	31460988
22,000	20	120	12	60	60	45	6	FXR703Ø22.000H7LB1G-CU111	31460989
24,000	20	120	12	60	60	45	6	FXR703Ø24.000H7LB1G-CU111	31460990
25,000	20	120	12	60	60	45	6	FXR703Ø25.000H7LB1G-CU111	31460991
28,000	25	135	12	60	75	60	6	FXR703Ø28.000H7LB1G-CU111	31460992
30,000	25	135	12	60	75	60	6	FXR703Ø30.000H7LB1G-CU111	31460993
32,000	25	135	12	60	75	60	6	FXR703Ø32.000H7LB1G-CU111	31460994

**Configurable features**



**Bore diameter tolerance ≥ IT6:**  
- Diameter in increments of 0.001 mm freely selectable  
- Can be ordered in tolerance ≥ IT6

**Specification:**  
FXR703Ø[**Diameter**][**Tolerance**]LB1G-CU111

**G variants:**  
- Diameter in increments of 0.001 mm freely selectable  
- Can be ordered from tolerances ≥ 3 µm (G variant, see cutting data)

**G variant specification:**  
FXR703GØ[**Diameter**][**Tolerance**]LB1G-CU111

**Dimensions of configurable series IT6**

d <sub>1</sub>	d <sub>2</sub>	l <sub>1</sub>	l <sub>2</sub>	l <sub>3</sub>	l <sub>4</sub>	l <sub>5</sub>	z
9,900 - 15,899	12	95	8	45	50	38	6
15,899 - 18,899	16	100	12	50	50	38	6
18,900 - 25,899	20	120	12	60	60	45	6
25,900 - 32,200	25	135	12	60	75	60	6

**IT6 tolerance example:**  
FXR703Ø**16,350**H6LB1G-CU111

Bore diameter d<sub>1</sub> = 16.350 H6

**G variant example:**  
FXR703GØ**16,350**-3LB1G-CU111

Special tool diameter d<sub>1</sub> = 16.350 -3 µm

Dimensions in mm.  
For cutting data recommendations, see chapter "Technical Appendix".

# FixReam 700

Expanding design, long, for blind bore  
FXR705

**Design:**

Reamer diameter: 9.900 - 32.200 mm  
Lead: LB1G  
Cutting material: CU111  
Uncoated cermet

**Application:**

The expansion system is therefore only suitable for compensation prior to re-grinding and not for setting or re-adjusting the diameter.

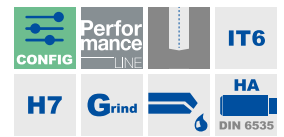
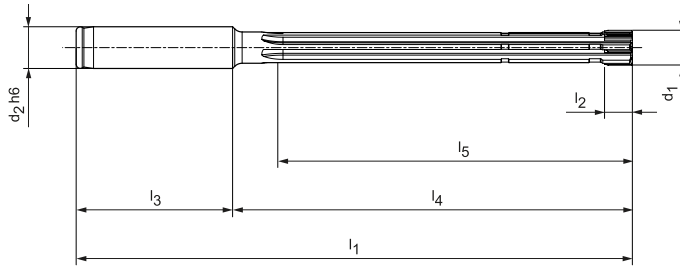

**Preferred series in H7**

d <sub>1</sub> H7	Dimensions						z	Specification	Order no.
	d <sub>2</sub> h6	l <sub>1</sub>	l <sub>2</sub>	l <sub>3</sub>	l <sub>4</sub>	l <sub>5</sub>			
10,000	12	160	8	45	115	100	6	FXR705Ø10.000H7LB1G-CU111	31460995
12,000	12	160	8	45	115	100	6	FXR705Ø12.000H7LB1G-CU111	31460996
14,000	12	160	8	45	115	100	6	FXR705Ø14.000H7LB1G-CU111	31460997
16,000	16	180	12	50	130	114	6	FXR705Ø16.000H7LB1G-CU111	31460998
18,000	16	180	12	50	130	115	6	FXR705Ø18.000H7LB1G-CU111	31460999
20,000	20	200	12	60	140	120	6	FXR705Ø20.000H7LB1G-CU111	31461000
22,000	20	200	12	60	140	120	6	FXR705Ø22.000H7LB1G-CU111	31461001
24,000	20	200	12	60	140	120	6	FXR705Ø24.000H7LB1G-CU111	31461002
25,000	20	200	12	60	140	120	6	FXR705Ø25.000H7LB1G-CU111	31461003
28,000	25	210	12	60	150	130	6	FXR705Ø28.000H7LB1G-CU111	31461004
30,000	25	210	12	60	150	130	6	FXR705Ø30.000H7LB1G-CU111	31461005
32,000	25	210	12	60	150	130	6	FXR705Ø32.000H7LB1G-CU111	31461006

**Configurable features**



**Bore diameter tolerance ≥ IT6:**  
- Diameter in increments of 0.001 mm freely selectable  
- Can be ordered in tolerance ≥ IT6

**Specification:**  
FXR705Ø[**Diameter**][**Tolerance**]LB1G-CU111

**G variants:**  
- Diameter in increments of 0.001 mm freely selectable  
- Can be ordered from tolerances ≥ 3 µm (G variant, see cutting data)

**G variant specification:**  
FXR705GØ[**Diameter**][**Tolerance**]LB1G-CU111

**Dimensions of configurable series IT6**

d <sub>1</sub>	d <sub>2</sub>	l <sub>1</sub>	l <sub>2</sub>	l <sub>3</sub>	l <sub>4</sub>	l <sub>5</sub>	z
9,900 - 15,899	12	160	8	45	115	100	6
15,900 - 18,990	16	180	12	50	130	113	6
18,900 - 25,899	20	200	12	60	140	120	6
25,900 - 32,200	25	210	12	60	150	130	6

**IT6 tolerance example:**  
FXR705Ø**16,350**H6LB1G-CU111

Bore diameter d<sub>1</sub> = 16.350 H6

**G variant example:**  
FXR705GØ**16,350**-3LB1G-CU111

Special tool diameter d<sub>1</sub> = 16.350 -3 µm

Dimensions in mm.  
For cutting data recommendations, see chapter "Technical Appendix".

# NC machine reamer

Fixed design, straight fluted, for through hole  
MDR500

**Design:**

Reamer diameter: 1.000 - 13.000 mm  
Cutting direction: Right-hand cutting  
Cutting material: HU613  
Groove direction: Straight fluted  
Geometry: EU spacing  
(from  $\varnothing$  3 mm)

**Application:**

For straight shank diameters suitable for the connection in hydraulic chucks, high-accuracy chucks and shrink chucks.

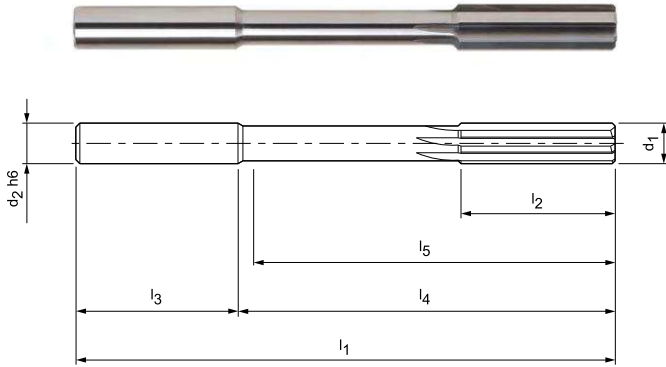

**Preferred series in H7**

d <sub>1</sub> H7	Dimensions						z	Specification	Order no.
	d <sub>2</sub> h6	l <sub>1</sub>	l <sub>2</sub>	l <sub>3</sub>	l <sub>4</sub>	l <sub>5</sub>			
1,000	3	50	6	28	22	17,5	3	MDR500-8093-2A01H7-HU613	30719105
1,100	3	50	9	28	22	17,5	3	MDR500-8093-2A01.1H7-HU613	30719106
1,200	3	50	9	28	22	17,5	3	MDR500-8093-2A01.2H7-HU613	30719107
1,500	3	50	9	28	22	18	3	MDR500-8093-2A01.5H7-HU613	30719108
1,600	3	50	10	28	22	18	3	MDR500-8093-2A01.6H7-HU613	30719109
1,800	3	50	11	28	22	18,5	4	MDR500-8093-2A01.8H7-HU613	30719110
2,000	3	50	12	28	22	18,5	4	MDR500-8093-2A02H7-HU613	30719111
2,200	3	50	12	28	22	18,5	4	MDR500-8093-2A02.2H7-HU613	30719112
2,500	3	60	16	28	32	29	4	MDR500-8093-2A02.5H7-HU613	30719113
3,000	4	65	17	28	37	33	6	MDR500-8093-2A03H7-HU613	30719114
3,200	4	65	18	28	37	33	6	MDR500-8093-2A03.2H7-HU613	30719115
3,500	4	75	18	28	47	43	6	MDR500-8093-2A03.5H7-HU613	30719116
4,000	4	75	19	28	47	43	6	MDR500-8093-2A04H7-HU613	30712856
4,500	6	80	21	36	44	39	6	MDR500-8093-2A04.5H7-HU613	30712857
5,000	6	93	23	36	57	52	6	MDR500-8093-2A05H7-HU613	30712858
5,500	6	93	26	36	57	53	6	MDR500-8093-2A05.5H7-HU613	30712859
6,000	6	93	26	36	57	53	6	MDR500-8093-2A06.00H7-HU613	30930185
6,500	6	101	28	36	65	61	6	MDR500-8093-2A06.5H7-HU613	30712861
7,000	8	109	31	36	73	68	6	MDR500-8093-2A07.0H7-HU613	30214687
7,500	8	109	31	36	73	68	6	MDR500-8093-2A07.5H7-HU613	30712863
8,000	8	117	33	36	81	77	6	MDR500-8093-2A08H7-HU613	30712864
8,500	8	117	33	36	81	77	6	MDR500-8093-2A08.5H7-HU613	30712865
9,000	10	125	36	40	85	80	6	MDR500-8093-2A09H7-HU613	30712866
9,500	10	125	36	40	85	80	6	MDR500-8093-2A09.5H7-HU613	30712867
10,000	10	133	38	40	93	88	6	MDR500-8093-2A10H7-HU613	30712868
10,500	10	133	38	40	93	88	6	MDR500-8093-2A10.5H7-HU613	30712869
11,000	10	142	41	40	102	97	6	MDR500-8093-2A11H7-HU613	30712870
12,000	12	151	44	45	106	100	6	MDR500-8093-2A12H7-HU613	30712871
13,000	12	151	44	45	106	100	6	MDR500-8093-2A13H7-HU613	30712872

Dimensions in mm.

For cutting data recommendations, see Chapter "Technical Appendix".

Special designs and possible coatings available upon request.

# NC machine reamer

Fixed design, spiral fluted, for through bore  
MDR510

**Design:**

Reamer diameter: 0.980 - 13.000 mm  
Cutting direction: Right-hand cutting  
Cutting material: HU613  
Groove direction: Spiral fluted  
Geometry: EU spacing  
(from  $\varnothing$  3 mm)

**Application:**

For straight shank diameters suitable for the connection in hydraulic chucks, high-accuracy chucks and shrink chucks.

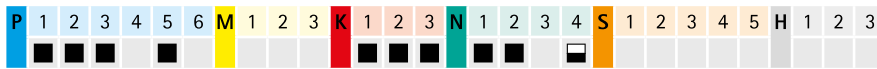
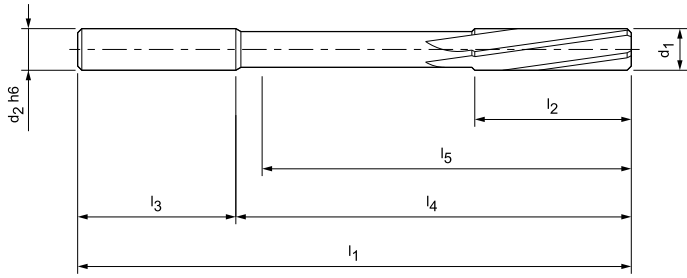

Preferred series available from stock in H7 | +0.004

Dimensions								z	Specification	Order no.
d <sub>1</sub>	Tolerance	d <sub>2</sub> h6	l <sub>1</sub>	l <sub>2</sub>	l <sub>3</sub>	l <sub>4</sub>	l <sub>5</sub>			
0,980	+0,004	3	50	6	28	22	17,5	3	MDR510G-8093-2B00.98+4-HU613	30712880
0,990	+0,004	3	50	6	28	22	17,5	3	MDR510G-8093-2B00.99+4-HU613	30712881
1,000	H7	3	50	6	28	22	17,5	3	MDR510-8093-2B01.00H7-HU613	30712882
1,010	+0,004	3	50	6	28	22	17,5	3	MDR510G-8093-2B01.01+4-HU613	30712883
1,020	+0,004	3	50	6	28	22	17,5	3	MDR510G-8093-2B01.02+4-HU613	30712884
1,030	+0,004	3	50	6	28	22	17,5	3	MDR510G-8093-2B01.03+4-HU613	30712885
1,100	H7	3	50	9	28	22	17,5	3	MDR510-8093-2B01.10H7-HU613	30712886
1,200	H7	3	50	9	28	22	17,5	3	MDR510-8093-2B01.20H7-HU613	30712887
1,480	+0,004	3	50	9	28	22	18	3	MDR510G-8093-2B01.48+4-HU613	30712888
1,490	+0,004	3	50	9	28	22	18	3	MDR510G-8093-2B01.49+4-HU613	30712889
1,500	H7	3	50	9	28	22	18	3	MDR510-8093-2B01.50H7-HU613	30712890
1,510	+0,004	3	50	10	28	22	18	3	MDR510G-8093-2B01.510+4-HU613	30712891
1,520	+0,004	3	50	10	28	22	18	3	MDR510G-8093-2B01.520+4-HU613	30712892
1,530	+0,004	3	50	10	28	22	18	3	MDR510G-8093-2B01.530+4-HU613	30712893
1,600	H7	3	50	10	28	22	18	3	MDR510-8093-2B01.60H7-HU613	30712894
1,800	H7	3	50	11	28	22	18,5	4	MDR510-8093-2B01.80H7-HU613	30712895
1,980	+0,004	3	50	12	28	22	18,5	4	MDR510G-8093-2B01.98+4-HU613	30712896
1,990	+0,004	3	50	12	28	22	18,5	4	MDR510G-8093-2B01.99+4-HU613	30712897
2,000	H7	3	50	12	28	22	18,5	4	MDR510-8093-2B02.00H7-HU613	30712898
2,010	+0,004	3	50	12	28	22	18,5	4	MDR510G-8093-2B02.01+4-HU613	30712899
2,020	+0,004	3	50	12	28	22	18,5	4	MDR510G-8093-2B02.02+4-HU613	30712900
2,030	+0,004	3	50	12	28	22	18,5	4	MDR510G-8093-2B02.03+4-HU613	30712901
2,200	H7	3	50	12	28	22	18,5	4	MDR510-8093-2B02.20H7-HU613	30949620
2,480	+0,004	3	60	16	28	32	29	4	MDR510G-8093-2B02.48+4-HU613	30712903
2,490	+0,004	3	60	16	28	32	29	4	MDR510G-8093-2B02.49+4-HU613	30712904
2,500	H7	3	60	16	28	32	29	4	MSR510-8093-2B02.50H7-HU613	30852070
2,510	+0,004	3	60	16	28	32	29	4	MDR510-8093-2B02.50+4-HU613	30814471
2,520	+0,004	3	60	16	28	32	29	4	MDR510-8093-2B02.52+4-HU613	30969608
2,530	+0,004	3	60	16	28	32	29	4	MSR510G-8093-2B02.53+4-HU613	30703326
2,970	+0,004	4	65	17	28	37	33	6	MDR510G-8093-2B02.97+4-HU613	30712909
2,980	+0,004	4	65	17	28	37	33	6	MDR510G-8093-2B02.98+4-HU613	30929829
2,990	+0,004	4	65	17	28	37	33	6	MDR510G-8093-2B02.99+4-HU613	30929822
3,000	H7	4	65	17	28	37	33	6	MDR510-8093-2B03.00H7-HU613	30712912
3,010	+0,004	4	65	17	28	37	33	6	MDR510G-8093-2B03.01+4-HU613	30712913
3,020	+0,004	4	65	17	28	37	33	6	MDR510G-8093-2B03.02+4-HU613	30712914
3,030	+0,004	4	65	17	28	37	33	6	MDR510G-8093-2B03.03+4-HU613	30712915
3,200	H7	4	65	18	28	37	33	6	MSR510-8093-2B03.20H7-HU613	30852043
3,500	H7	4	75	18	28	47	43	6	MDR510-8093-2B03.50H7-HU613	30712917

NC machine reamer | Fixed design, spiral fluted, for through bore | MDR510

Dimensions								z	Specification	Order no.
d <sub>1</sub>	Tolerance	d <sub>2</sub> h6	l <sub>1</sub>	l <sub>2</sub>	l <sub>3</sub>	l <sub>4</sub>	l <sub>5</sub>			
3,970	+0,004	4	75	19	28	47	43	6	MDR510G-8093-2B03.97+4-HU613	30712918
3,980	+0,004	4	75	19	28	47	43	6	MDR510G-8093-2B03.98+4-HU613	30712919
3,990	+0,004	4	75	19	28	47	43	6	MDR510G-8093-2B03.99+4-HU613	30712920
4,000	H7	4	75	19	28	47	43	6	MDR510G-8093-2B04.00+4-HU613	30215703
4,010	+0,004	4	75	19	28	47	43	6	MDR510G-8093-2B04.01+4-HU613	30712922
4,020	+0,004	4	75	19	28	47	43	6	MDR510G-8093-2B04.02+4-HU613	30712923
4,030	+0,004	4	75	19	28	47	43	6	MDR510G-8093-2B04.03+4-HU613	30712924
4,500	H7	6	80	21	36	44	39	6	MDR510-8093-2B04.50H7-HU613	30712925
4,970	+0,004	6	93	23	36	57	52	6	MDR510G-8093-2B04.97+4-HU613	30712926
4,980	+0,004	6	93	23	36	57	52	6	MDR510G-8093-2B04.98+4-HU613	30712927
4,990	+0,004	6	93	23	36	57	52	6	MDR510G-8093-2B04.99+4-HU613	30712928
5,000	H7	6	93	23	36	57	52	6	MDR510-8093-2B05.00H7-HU613	30712929
5,010	+0,004	6	93	23	36	57	52	6	MDR510G-8093-2B05.01+4-HU613	30712930
5,020	+0,004	6	93	23	36	57	52	6	MSR510G-8093-2B05.02+4-HU613	30876196
5,030	+0,004	6	93	23	36	57	52	6	MSR510G-8093-2B05.03+4-HU613	30876194
5,500	H7	6	93	26	36	57	53	6	MDR510-8093-2B05.50H7-HU613	30712933
5,970	+0,004	6	93	26	36	57	53	6	MDR510G-8093-2B05.97+4-HU613	30712934
5,980	+0,004	6	93	26	36	57	53	6	MDR510-8093-2B05.980+4-HU613	30959542
5,990	+0,004	6	93	26	36	57	53	6	MDR510G-8093-2B05.99+4-HU613	30712936
6,000	H7	6	93	26	36	57	53	6	MDR510-8093-2B06.00H7-HU613	30712937
6,010	+0,004	6	93	26	36	57	53	6	MDR510G-8093-2B06.01+4-HU613	30712938
6,020	+0,004	6	93	26	36	57	53	6	MDR510G-8093-2B06.02+4-HU613	30712939
6,030	+0,004	6	93	26	36	57	53	6	MDR510G-8093-2B06.03+4-HU613	30712940
6,500	H7	6	101	28	36	65	61	6	MDR510-8093-2B06.50H7-HU613	30712941
7,000	H7	8	109	31	36	73	68	6	MDR510-8093-2B07.00H7-HU613	30712942
7,500	H7	8	109	31	36	73	68	6	MDR510-8093-2B07.50H7-HU613	30712943
7,970	+0,004	8	117	33	36	81	77	6	MDR510G-8093-2B07.97+4-HU613	30712944
7,980	+0,004	8	117	33	36	81	77	6	MDR510G-8093-2B07.98+4-HU613	30712945
7,990	+0,004	8	117	33	36	81	77	6	MDR510G-8093-2B07.99+4-HU613	30712946
8,000	H7	8	117	33	36	81	77	6	MDR510-8093-2B08.00H7-HU613	30712947
8,010	+0,004	8	117	33	36	81	77	6	MDR510G-8093-2B08.01+4-HU613	30712948
8,020	+0,004	8	117	33	36	81	77	6	MDR510G-8093-2B08.02+4-HU613	30712949
8,030	+0,004	8	117	33	36	81	77	6	MDR510G-8093-2B08.03+4-HU613	30712950
8,040	+0,004	8	117	33	36	81	77	6	MDR510G-8093-2B08.04+4-HU613	30712951
8,500	H7	8	117	33	36	81	77	6	MDR510-8093-2B08.50H7-HU613	30712952
9,000	H7	10	125	36	40	85	80	6	MDR510-8093-2B09.00H7-HU613	30712953
9,500	H7	10	125	36	40	85	80	6	MDR510-8093-2B09.50H7-HU613	30712954
9,970	+0,004	10	133	38	40	93	88	6	MDR510G-8093-2B09.97+4-HU613	30712955
9,980	+0,004	10	133	38	40	93	88	6	MDR510G-8093-2B09.98+4-HU613	30712956
9,990	+0,004	10	133	38	40	93	88	6	MDR510G-8093-2B09.99+4-HU613	30712957
10,000	H7	10	133	38	40	93	88	6	MSR510-8093-2B010.00H7-HU613	30860873
10,010	+0,004	10	133	38	40	93	88	6	MDR510G-8093-2B010.01+4-HU613	30712959
10,020	+0,004	10	133	38	40	93	88	6	MDR510G-8093-2B010.02+4-HU613	30712960
10,030	+0,004	10	133	38	40	93	88	6	MDR510G-8093-2B010.03+4-HU613	30712961
10,040	+0,004	10	133	38	40	93	88	6	MDR510G-8093-2B010.04+4-HU613	30712962
10,050	+0,004	10	133	38	40	93	88	6	MDR510G-8093-2B010.05+4-HU613	30712963
10,500	H7	10	133	38	40	93	88	6	MDR510-8093-2B010.50H7-HU613	30712964
11,000	H7	10	142	41	40	102	97	6	MDR510-8093-2B011.00H7-HU613	30712965
11,970	+0,004	12	151	44	45	106	100	6	MDR510G-8093-2B011.97+4-HU613	30712966
11,980	+0,004	12	151	44	45	106	100	6	MDR510G-8093-2B011.98+4-HU613	30712967
11,990	+0,004	12	151	44	45	106	100	6	MDR510G-8093-2B011.99+4-HU613	30712968
12,000	H7	12	151	44	45	106	100	6	MDR510-8093-2B012.00H7-HU613	30712969
12,010	+0,004	12	151	44	45	106	100	6	MDR510G-8093-2B012.01+4-HU613	30712970
12,020	+0,004	12	151	44	45	106	100	6	MDR510G-8093-2B012.02+4-HU613	30712971
12,030	+0,004	12	151	44	45	106	100	6	MDR510-8093-2B012.03+4-HU613	30935584
12,040	+0,004	12	151	44	45	106	100	6	MDR510G-8093-2B012.04+4-HU613	30712973
12,050	+0,004	12	151	44	45	106	100	6	MDR510G-8093-2B012.05+4-HU613	30712974
13,000	H7	12	151	44	45	106	100	6	MDR510-8093-2B013.00H7-HU613	30712975

Dimensions in mm.

For cutting data recommendations, see Chapter "Technical Appendix".

Special designs and possible coatings available upon request.

# PRECISE VALVE SEAT MACHINING WITH HNHX INDEXABLE INSERTS

More cutting edges for lower costs per part

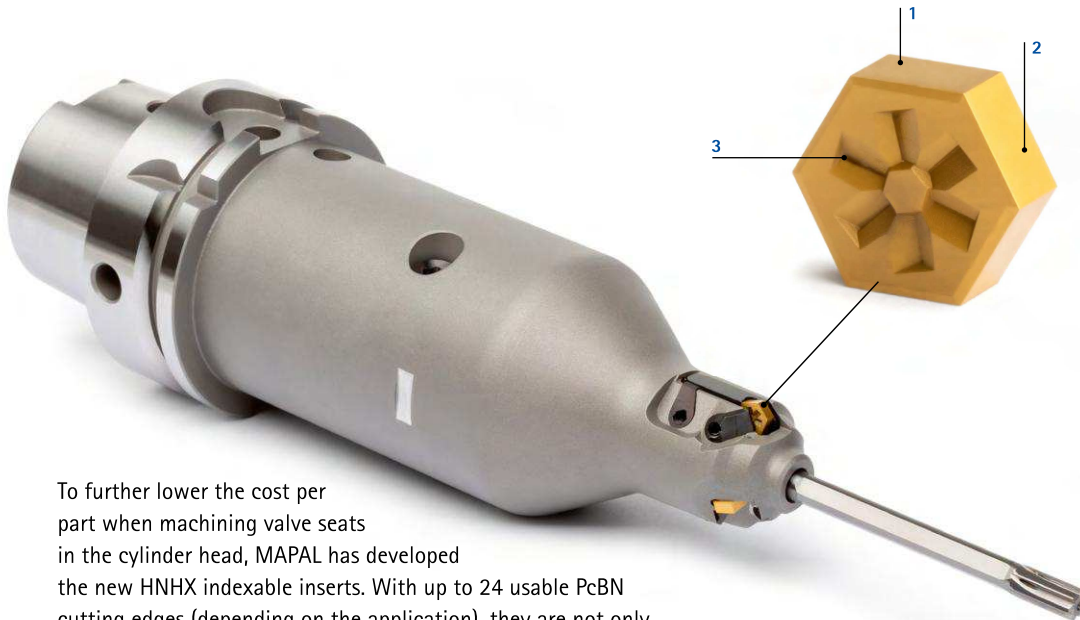

To further lower the cost per part when machining valve seats in the cylinder head, MAPAL has developed the new HNHX indexable inserts. With up to 24 usable PcBN cutting edges (depending on the application), they are not only particularly economical but also make the most effective use of the cutting material. Thanks to the high-quality cutting edges, the new HNHX indexable inserts allow for surface finishes greater than  $R_a$  0.2  $\mu\text{m}$ .

**1 New HNHX cutting edge geometry**

- Up to 24 cutting edge inserts possible
- Significantly reduces costs per part

**2 New PcBN high-performance cutting material**

- Excellent cutting edge qualities
- Achieves surface finishes  $< R_a$  0.2

**3 Unique clamping system**

- Maximum force closure
- Uniform pressure distribution in the insert seat

## From practice

Material: Sintered material | part: Cylinder-head valve-seat machining

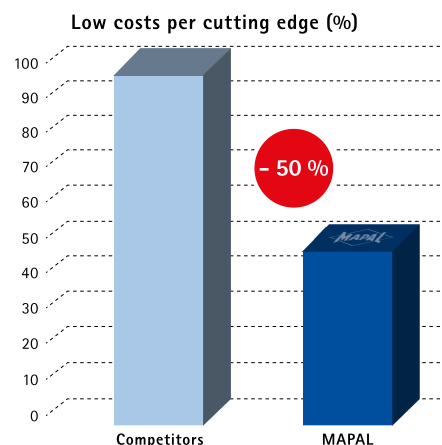
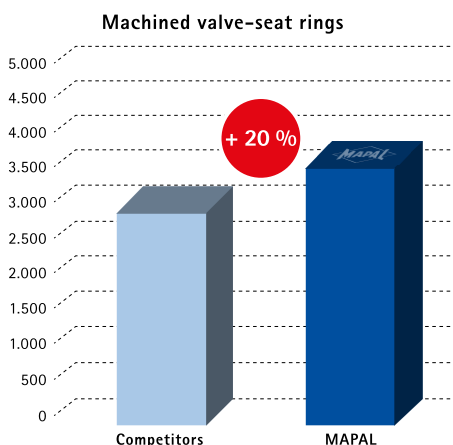

## Customer benefits

	MAPAL HNHX indexable inserts	Competitors
Number of cutting edges	Max. 24	Max. 12
Tool life	3,600 valve seat rings	3,000 valve seat rings
Cost per part	€ 0.0019	€ 0.0044
Handling	Available as fixed blade seat and adjustable with cassette (depending on workpiece tolerance)	Must always be adjusted
Available blade	Available ex-stock	Delivery time 6 to 8 weeks
Cutting material	PcBN high-performance cutting materials adapted to the current workpiece materials in the valve train	Standard quality



# HNHX

Indexable inserts for valve seat machining



	PcBN		
Workpiece material	H	H1.1   H1.2	
Cutting material type	FP457	FP820	FP931
Cutting edge design	0AS		

**Incircle ø [mm]**

HNHX0600R70R-0AS-...	6	31353791	31432260	31432261
HNHX0800R71R-0AS-...	8	31436703	31440725	31440726

### Troubleshooting | Wear and tear

Selection of the correct cutting material for valve seat machining in case of wear and tear issues.

The coating makes wear and tear of the cutting edge visible, which helps to determine the correct time for replacing the indexable insert.

Cutting material	Recommendation for...				
	Blade breakage	Surface disintegration (ridge cracks)	Abrasive load (friction wear)	Adhesive load (built-up edge)	Tribochemical load (crater wear)
FP457			✓		✓
FP820				✓	
FP931	✓	✓			

#### Information

It is important to consider the specific requirements of the application and, if necessary, consult one of our tool technology experts to determine the optimum cutting material for valve seat machining.

# Product overview for indexable inserts 1/2

## Radial technology

Insert type	Radial technology – Basic Line							
	CCMT	CCGT	DCMT	SCMT   SPMT	SCGT	TCMT	VCMT	VCGT
								

## Features

Number of cutting edges	2	2	2	4	4	3	2	2
Insert size	06 / 09 / 12	06 / 09 / 12	07 / 11 / 15	06 / 09 / 12	09	09 / 11 / 16 / 22	16	11
Diameter range	from 17 mm	from 17 mm		from 17 mm	from 25 mm	from 17 mm		
Cutting direction	N	N	N	N	N	N	N	N
Boring – neutral	■	■	■	■	■	■	■	■
Boring – arc-shaped land								
Countersinking / chamfering								

## Application

Roughing	■		■	■		■	■	
Medium machining	■	■	■	■		■	■	■
Finishing	■	■	■	■	■	■		

## Cutting material

Ground carbide		■						■
Pressed carbide	■		■	■		■	■	
Cermet		■	■		■	■	■	
PcBN								
PCD								

## Material suitability

P	■	■	■	■	■	■	■	■
M <sub>1</sub>	■	■	■	■		■		■
M <sub>2</sub>	■	■	■	■		■		■
K	■		■	■		■	■	
N		■			■			
X								

Page	BC	BC	BC	BC	BC	BC	BC	BC
------	----	----	----	----	----	----	----	----

\* With favourable installation situation    Stainless steel    Heat-resistant cast steel (turbocharger materials)



2	2	2	4	4	2	4	3	1
06 / 09	06 / 09 / 12	06 / 09	06 / 09 / 12	06 / 09 / 12	06 / 09 / 12	09 / 12	06 / 09 / 11 / 16	06 / 09 / 11 / 16
from 17 mm	from 17 mm	from 24 mm	from 17 mm	from 17 mm	from 17 mm	from 25 mm	from 15 mm	from 15 mm
N	L / R	N	N	L / R	X	N	L / R	X
■	■	■	■	■	■	■	■	■

■	■	■	■	■	■	■	■	■
■	■	■	■	■	■	■	■	■



■	■	■	■	■	■	■	■	■

■	■	■	■	■	■	■	■	■
	■	■		■	■	■	■	■
		■				■		

BC	BC	62	BC	BC	BC	70	BC	BC
----	----	----	----	----	----	----	----	----

# Product overview for indexable inserts 2/2

## Tangential technology

Insert type	Radial technology – Performance Line							
	CCGT	CCGW	DCGT	DCGW	SCGT   SPGT	SCGW   SPGW	TCGW	VBGW   VCGW
								

## Features

Number of cutting edges	1	1	1	1	1	1	1	1
Insert size	06 / 09	06 / 09	11	11	06 / 09	06 / 09 / 12	11	16
Diameter range	from 17 mm	from 17 mm			from 17 mm	from 17 mm	from 17 mm	
Cutting direction	N	N	N	N	L / R / N	N	N	N
Boring – neutral	■	■	■	■	■	■	■	■
Boring – arc-shaped land								
Countersinking / chamfering								

## Application

Roughing								
Medium machining	■	■	■		■	■	■	
Finishing	■	■	■	■	■	■	■	■









## Cutting material

Ground carbide								
Pressed carbide								
Cermet								
PcBN		■		■		■	■	■
PCD	■	■	■	■	■	■	■	

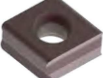
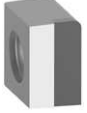
## Material suitability

P								
M <sub>1</sub>								
M <sub>2</sub>								
K		■		■		■	■	■
N	■	■	■	■	■	■	■	
X								

Page	BC	BC	BC	BC	BC	BC	BC	BC
------	----	----	----	----	----	----	----	----

Tangential technology – Performance Line									
CTNQ	CTGQ	CTHQ		FTNQ	FTGQ	FTHQ		STHD   STHE	
									
4	4	4	1	4	4	4	1	4	1
09 / 12	09 / 12	06 / 09 / 12	06 / 09 / 12	09 / 12	09 / 12	06 / 09 / 12	06 / 09 / 12	06 / 09	06 / 09
from 41 mm	from 65 mm	from 28 mm	from 28 mm	from 30 mm	from 30 mm	from 22 mm	from 22 mm		
L / R	L	L / R	L / R	L / R	L	L / R	L / R	N	N
■		■	■	■		■	■		
	■	■	■		■	■	■		
								■	■
■	■	■	■	■	■	■	■		
■	■	■	■	■	■	■	■		
■		■			■	■		■	
	■			■					
			■				■		■
■	■	■		■	■	■			
■	■	■		■		■			
■	■	■		■	■	■		■	
■		■	■			■	■	■	■
BC	BC	BC	BC	BC	BC	BC	BC	BC	BC

# Cutting material overview: Selection of the correct cutting material

## Selection of cutting material

The cutting materials cover a wide spectrum of wear resistance and ductility. The designation of the cutting material indicates the level of ductility; the ductility increases as the number increases.

CVD-coated cutting materials (HC...) are the first choice for boring K, P and M workpiece materials. This achieves the longest tool life.

**Example:** HC830 is more ductile than HC815 (the more ductile the cutting material, the less resistant it is to wear).

For non-ferrous workpiece materials, uncoated and PCD-coated carbide types (HU.../HP...) are the first choice. From a silicon content of ≥12%, PCD (PU...) is recommended due to increasing abrasiveness. With PCD, maximum tool life is achievable, which is why this cutting material is particularly suitable for large series.

1. Select your workpiece material according to the MMG (MAPAL machining groups; see fold-out page on inside cover).

2. Depending on the product line, select the type below the desired workpiece material from the corresponding **"Cutting materials overview [...]"** table.

3. Depending on the general conditions (see **"General conditions" table**), a wear-resistant or rather ductile CVD-coated cutting material should be selected.

4. If general conditions in the direction of the black arrows predominate and breakages cannot be prevented despite a ductile CVD grade, you should change to PVD-coated cutting materials.

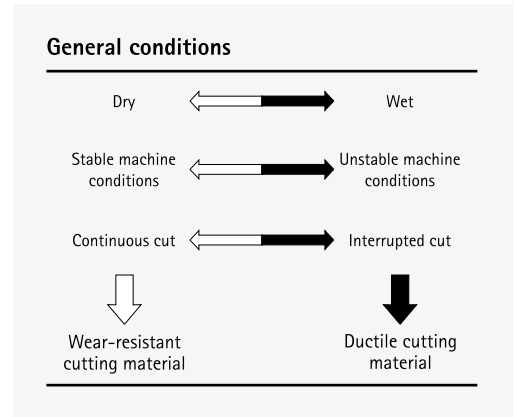

## Basic Line cutting material overview

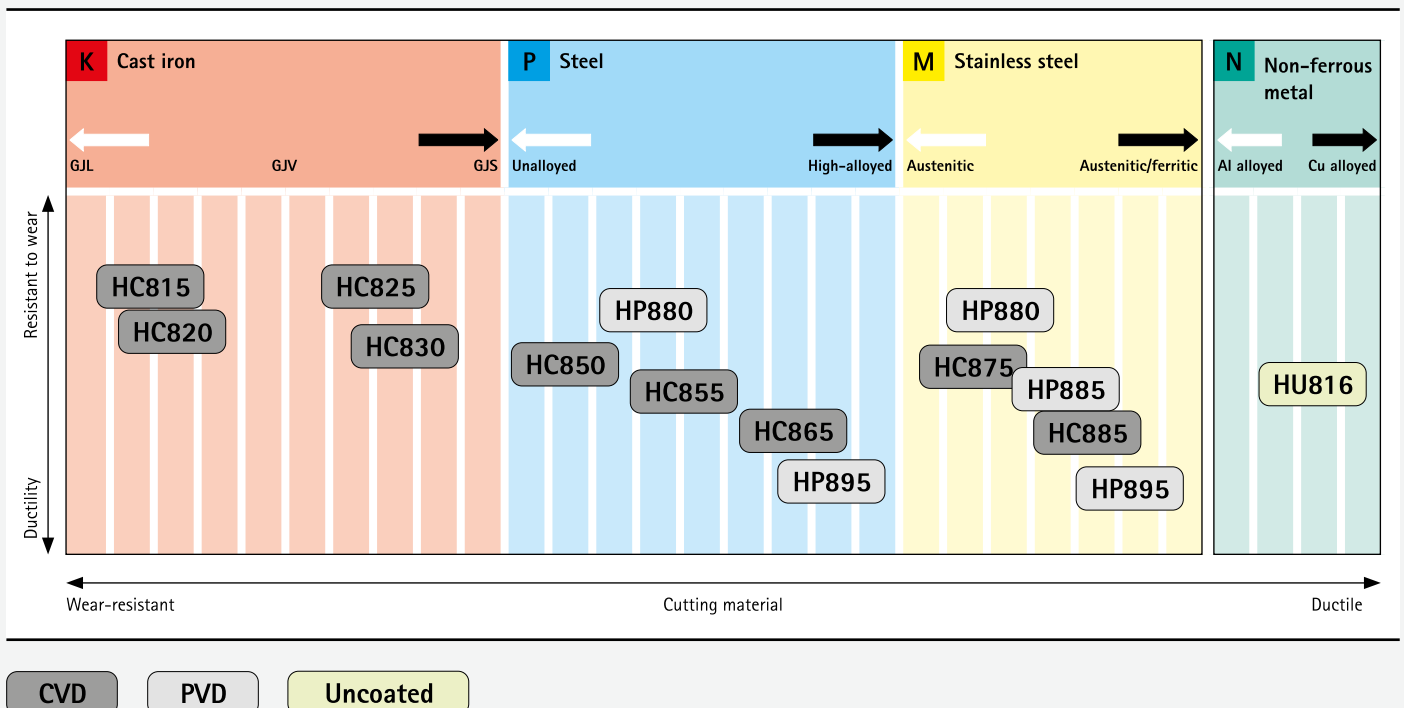

**X Cutting material series for mixed machining**

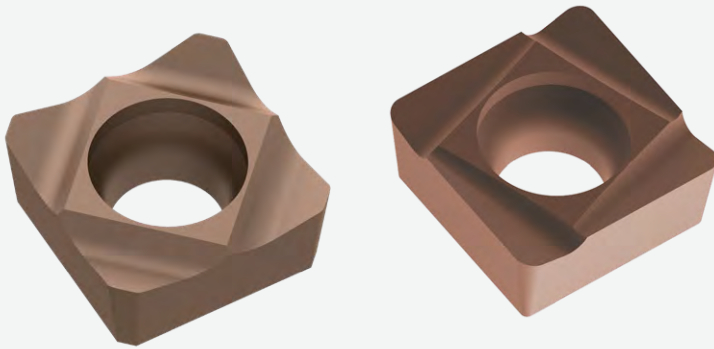

Material combinations of aluminium and sintered steel or aluminium and cast iron, such as those used in the manufacturing of the crankcase, place special demands on machining. MAPAL offers a specially adapted cutting material series for such machining operations. Both their carbide substrates and the micro and macro geometries of the cutting edges were specially developed for mixed machining.

A PVD coating as part of the cutting material series prevents both a built-up edge during aluminium machining and excessive wear and tear during machining of the cast iron or sintered steel portion of the workpiece. This is because it ensures that the cutting material is particularly wear-and-tear and heat resistant. In this way, machining can be carried out in the highest quality.

**AT A GLANCE**

- Cutting material for the machining of the material combinations aluminium and cast iron as well as aluminium and sintered steel
- Modified carbide substrate, optimised micro and macro geometries on the insert, PVD coating based on TiAlN alloy with special dopant
- Standard and custom ISO indexable inserts available
- Long tool life and therefore high economic efficiency

**Performance Line cutting material overview**

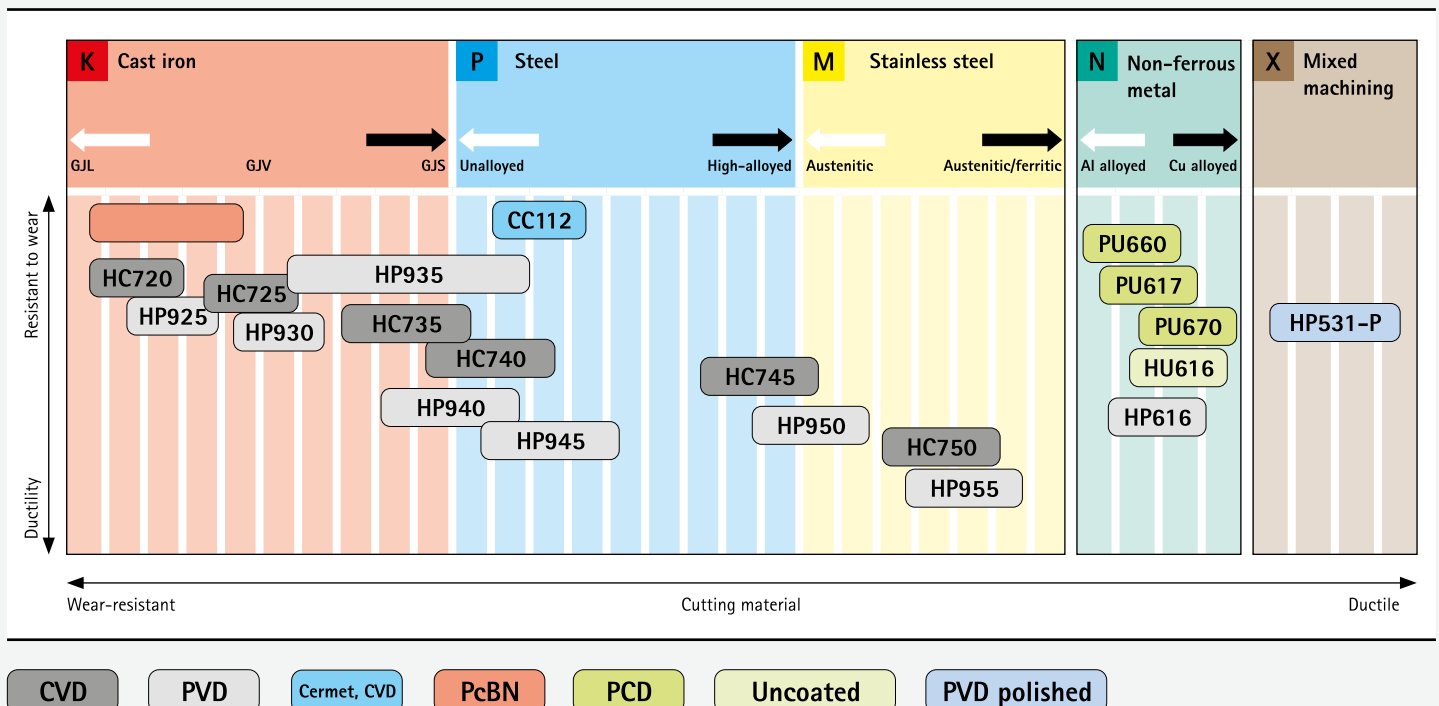

# Cutting materials overview:

## Types and type description

Substrate	Coating	Cutting material	Coating composition	Colour of coating	Field of application	Recommended application
Carbide	Uncoated	HU616 / HU816	-	-	●	Fine-grain carbide with very smooth surface for the general machining of aluminium wrought alloys and aluminium cast alloys with Si contents < 3%.
	PVD-coated	HP616	TiB2	Anthracite	●	Fine grain carbide with a partially reduced PVD coating for machining adhesive materials. First choice for increasing tool life compared to uncoated cutting edges in aluminium alloys with 7–12% silicon.
		HP880	TiAlN	Anthracite	●	Outstanding wear and heat resistance due to new PVD coating. Suitable for finishing steel and stainless steel.
		HP885	TiAlN + TiAlSiN	Copper	●	Temperature-resistant cutting material type, finest grain carbide with multilayer PVD coating for universal machining of stainless steels.
		HP895	TiAlN	Anthracite	✚	TiAlN-coated finest grain carbide with high binder content. Optimised interaction of wear resistance and ductility. Suitable for semi-finishing steel and stainless steel.
		HP930	AlTiCrN	Black anthracite	●	Fine grain carbide with PVD top coating. Grade for semi-machining and roughing, for machining GJL and GJS.
		HP940	AlTiCrN	Black anthracite	✚	Fine grain carbide with PVD top coating. Grade for boring in the area of roughing to semi-machining with interrupted cuts or for unstable conditions while machining GJS.
		HP945	AlTiCrN	Black anthracite	✚	Fine grain carbide with PVD top coating. For boring steels or stainless steels as well as heat-resistant cast steel.
		HP950	TiAlSiN	Copper	✚	Ductile fine-grain carbide with PVD coating. For boring workpiece material with highest tensile strength, stainless steels and heat-resistant cast steel.
		HP955	TiAlSiN	Copper	✚	Tough fine grain with balanced ductility and PVD coating. For boring workpiece materials with highest tensile strength, stainless steels up to heat-resistant cast steel.
		*	<sup>N</sup> HP531	TiAlXN	Gold brown	●
PCD	I	PU617	-	-	●	PCD grade with medium particle size for roughing to semi-machining in non-ferrous metals and for machining abrasive materials.
		PU660	-	-	●	Fine grain PCD grade for finishing non-ferrous metals as well as non-metallic workpiece materials such as fibre-reinforced plastics. The fine grain lends the insert very good sharpness (chipping) with good resistant to wear and achieves high surface finishes.
		PU670	-	-	✚	PCD cutting material with medium to coarse particle size. Excellent mechanical resistant to wear with good ductility, particularly suitable for machining abrasive workpiece materials.

\* PVD-coated, mixed machining





# Overview of chip guiding stages – boring

## Radial indexable inserts

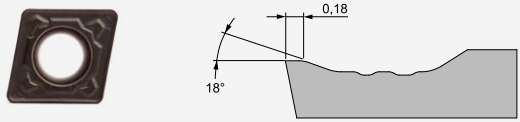
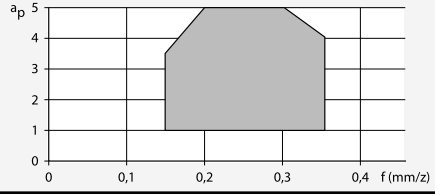
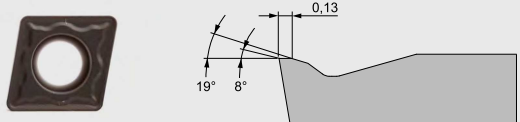
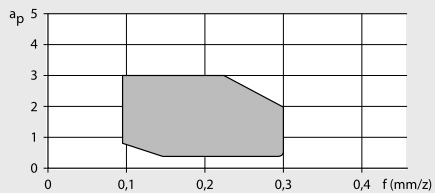
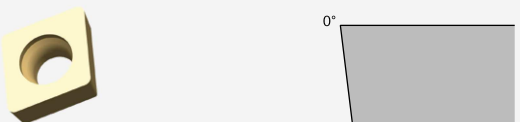
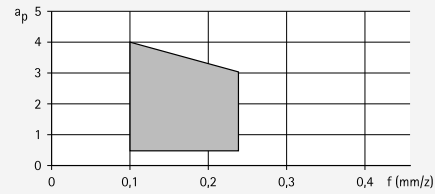
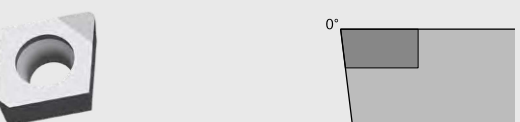
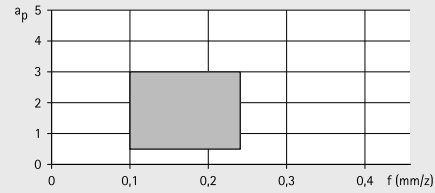
	Type	Workpiece material group	Edge rounding	Diagram
Roughing	<b>MKM</b> 	P M K N	+++	
	<b>MGP</b> 	P M K N	++	
Medium machining	<b>OA*</b> 	P M K N	+ ++	
	<b>OAA*</b> 	P M K N	0 + ++	

\* This chip guiding stage is available with different edge rounding.  
 0 = sharp edged | + = slightly rounded | ++ = medium rounded | +++ = heavily rounded

Radial indexable inserts

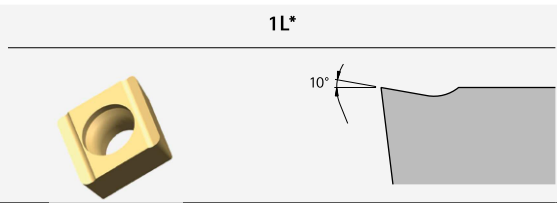
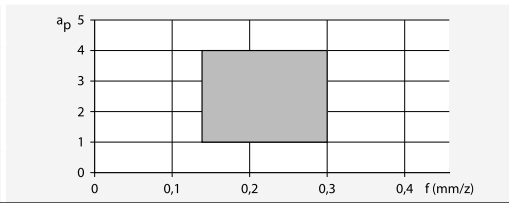
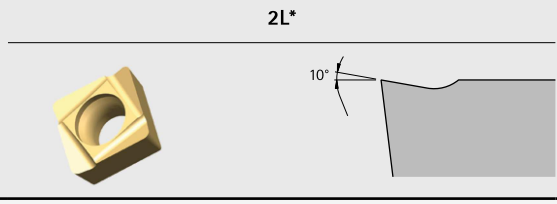
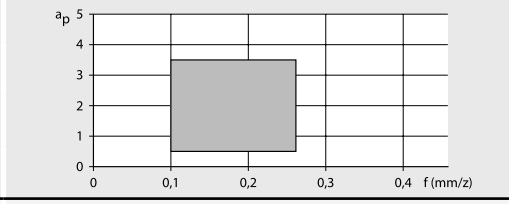
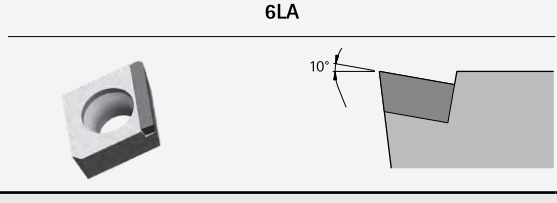
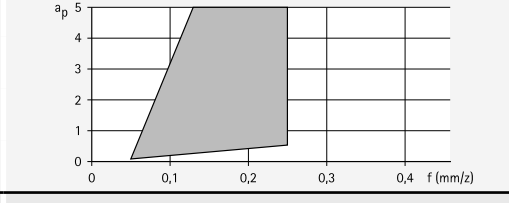
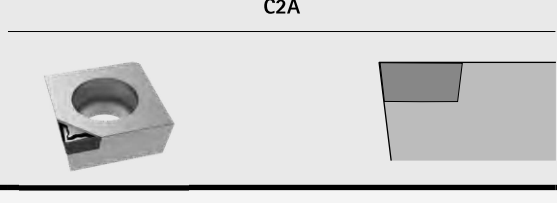
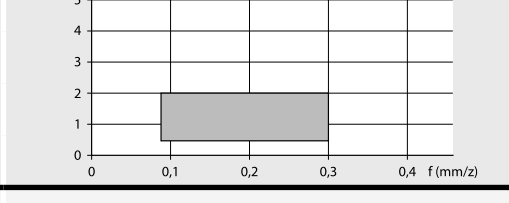
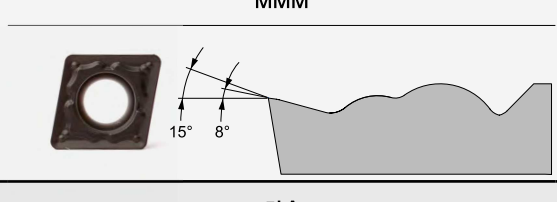
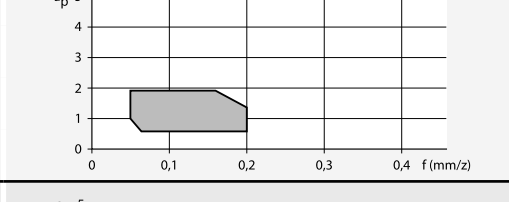
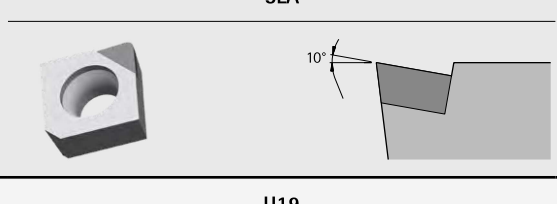
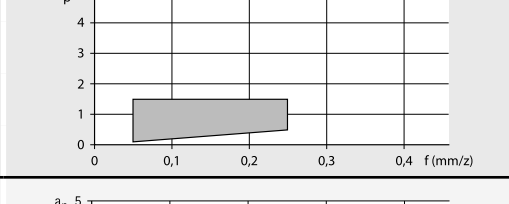
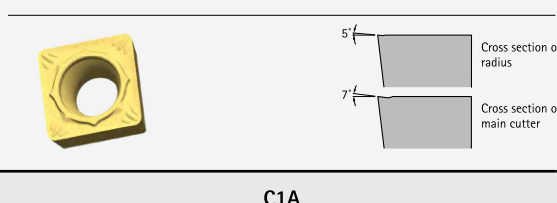
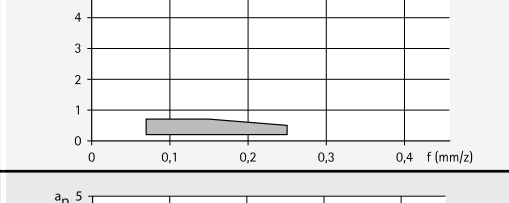
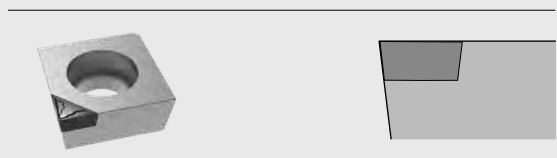
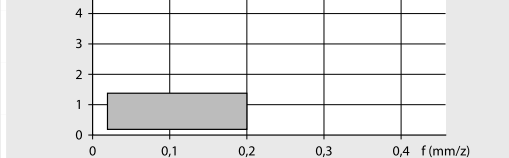
	Type	Workpiece material group	Edge rounding	Diagram
Medium machining	<b>1L*</b> 	P M <b>K</b> N	+ ++	
	<b>2L*</b> 	P M <b>K</b> N	+ ++	
	<b>6LA</b> 	P M K <b>N</b>	0	
	<b>C2A</b> 	P M K <b>N</b>	0	
	<b>MMM</b> 	P M <b>K</b> N	++	
Finishing	<b>5LA</b> 	P M K <b>N</b>	0	
	<b>U19</b> 	P M K N	+	
	<b>C1A</b> 	P M K <b>N</b>	0	



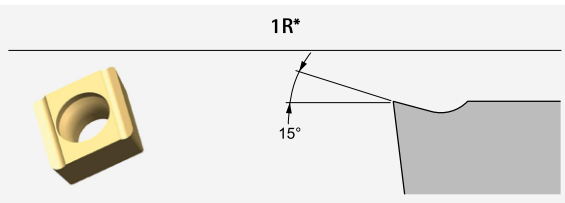
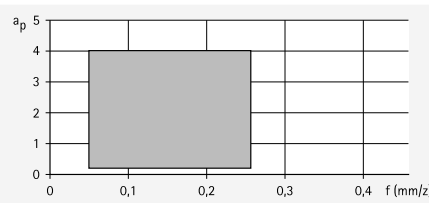
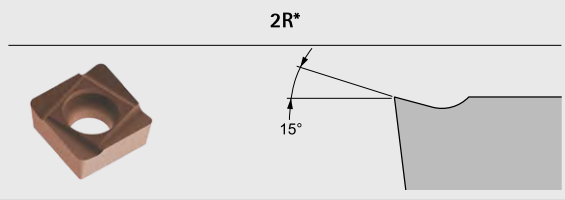
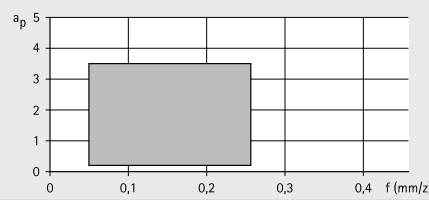

# Overview of chip guiding stages – boring

## Radial indexable inserts

	Type	Workpiece material group	Edge rounding	Diagram
Aluminium machining	<p><b>1R*</b></p> 	<p>P</p> <p>M</p> <p>K</p> <p><b>N</b></p>	0	
	<p><b>2R*</b></p> 	<p>P</p> <p>M</p> <p>K</p> <p><b>N</b></p>	0	

\* This chip guiding stage is available with different edge rounding.  
 0 = sharp edged | + = slightly rounded | ++ = medium rounded | +++ = heavily rounded

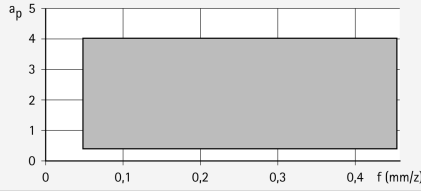
Radial indexable inserts

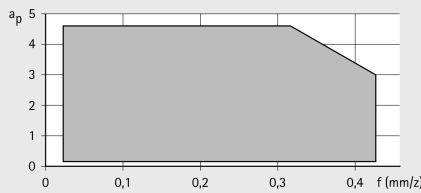
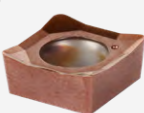
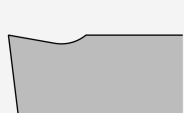
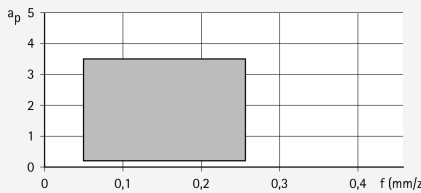
	Type	Workpiece material group	Edge rounding	Diagram
Aluminium machining highly positive	<b>MAL</b>  	P M K <b>N</b>	0	
	<b>M45</b>  	P M K <b>N</b>	0	
Mixed machining highly positive	<b>M41</b>  	X	+	

Note:

The SCGT blades with MAL, M40, M41 and M45 geometry can only be used conditionally for chamfer machining and exact shoulder machining due to their non-straight cutting edge and associated distortion.

Geometries with chip guiding stage "MMM", "1R" or "2R" are possible alternatives.



# CCGT

Radial indexable insert,  
double-edge, neutral design

Workpiece material	P		M	
Substrate	Cermet		Carbide	
Coating	CVD		PVD	
Cutting material type	CC112		HP895	

Cutting edge design			MGP	MGP	
<b>CCGT06</b>		$a_p$ max. [mm]			
Medium machining	CCGT060202N-...-...	0.2 - 2.0	30985376	30985376	
	CCGT060204F01L-...-...	0.1 - 3.0			
	CCGT060204F01R-...-...	0.1 - 3.0			
	CCGT060204N-...-...	0.5 - 2.0	30985378	30985378	
	CCGT060208F01L-...-...	0.1 - 3.0			
	CCGT060208F01R-...-...	0.1 - 3.0			
	CCGT060208N-...-...	0.7 - 2.0	30985393	30985393	
	<b>CCGT09</b>				
	CCGT09T302N-...-...	0.2 - 3.0	30985398	30985398	
	CCGT09T304F01L-...-...	0.1 - 4.5			
	CCGT09T304F01R-...-...	0.1 - 4.5			
	CCGT09T304F01N-...-...	0.4 - 1.6			
	CCGT09T304N-...-...	0.5 - 3.0	30985400	30985400	
	CCGT09T308F01L-...-...	0.1 - 4.5			
	CCGT09T308F01R-...-...	0.1 - 4.5			
	CCGT09T308F01N-...-...	0.5 - 2.0			
	CCGT09T308N-...-...	0.7 - 3.0	30985406	30985406	
	<b>CCGT12</b>				
	CCGT120404N-...-...	0.5 - 4.0	30985410	30985410	
CCGT120404F01L-...-...	0.1 - 7.0				
CCGT120408N-...-...	0.5 - 4.0	30985411	30985411		
CCGT120408F01L-...-...	0.1 - 7.0				

Specified  $a_p$  ranges are recommendations and can vary depending on the machined workpiece material.



Carbide/Cermet

Tipped variants, single-edge:

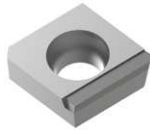

6LA

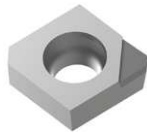

5LA



C1A



C2A

N					X
Al alloyed ← Wear-resistant			Cu alloyed → Ductile		
PCD					Carbide
-					-
HU816	HU616	PU617	PU660	PU670	HP531-P
MAL	M45	6LA		C2A	M41
		30708850			31479913
		31277722			
31488936	31176763				31483914
		30375239			
		31204099			
		30370125			
		30497774			
31488937	31005924			30234061	31448234
		30370124			
		30370397			
31488939	31184356			30234062	31481172
31488950	31028455				
		31025433			
31488951	30924033				
		30589862			

# CCGT

Radial indexable insert,  
double-edge, neutral design

Workpiece material	P		M	
Substrate	Cermet		Carbide	
Coating	CVD		PVD	
Cutting material type	CC112		HP895	
Cutting edge design	U19			
<b>CCGT06</b>	<b><math>a_p</math> max. [mm]</b>			
CCGT060202N-...-...	0.1 - 1.0			
CCGT060204N-...-...	0.1 - 0.5	30874908		
CCGT060204F01N-...-...	0.1 - 1.0			
CCGT060208N-...-...	0.2 - 0.5	30799422		
CCGT060208F01N-...-...	0.1 - 1.5			
<b>CCGT09</b>				
CCGT09T304N-...-...	0.1 - 2.0			
CCGT09T304F01N-...-...	0.1 - 2.0			
CCGT09T304F01N-...-...	0.1 - 1.0			
CCGT09T308N-...-...	0.1 - 2.0			
CCGT09T308F01N-...-...	0.1 - 2.0			
CCGT09T308F01N-...-...	0.1 - 1.4			
<b>CCGT12</b>				
CCGT120404N-...-...	0.4 - 4.0			
CCGT120408N-...-...	0.4 - 4.0			

Specified  $a_p$  ranges are recommendations and can vary depending on the machined workpiece material.



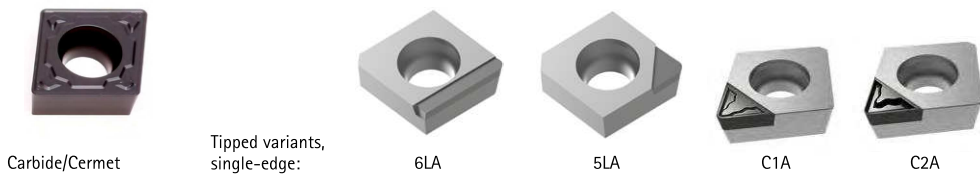

N					X
Al alloyed ← Wear-resistant					Cu alloyed → Ductile
PCD					Carbide
-					-
HU816	HU616	PU617	PU660	PU670	HP531-P
MAL	M45	5LA	C1A		M41
					31479913
31488936	31176763				31483914
		30708851	10104313		
		31277724			
31488937	31005924				31448234
		31079089			
			10099042		
31488939	31184356				31481172
		31277725			
			30234050		
31488950	31028455				
31488951	30924033				

# CCGW

Radial indexable inserts,  
double-edge, neutral design



Tipped variants,  
single-edge:

OAA

Workpiece material	K			N
	Carbide		PcBN	PCD
Substrate	Carbide		PcBN	PCD
Coating	CVD	PVD	-	-
Cutting material type	HC740	HP930	FU430	PU617

Cutting edge design		OA	OA	OAA		
CCGW06 $a_p$ max. [mm]						
Medium machining	CCGW060204E04N-...-...	0.5 - 3.2	31317178	30950259		
	CCGW060204T51N-...-...	0.5 - 2.0			10105523	
	CCGW060208E04N-...-...	0.5 - 3.2	31317202	30950280		
	CCGW09					
	CCGW09T304E04N-...-...	0.5 - 4.0	31027805	30950281		
	CCGW09T304T51N-...-...	0.5 - 2.5			10105636	
	CCGW09T308E04N-...-...	0.5 - 4.0	31023434	30950282		
	CCGW09T308T51N-...-...	0.5 - 2.5			10105650	
CCGW09T312E04N-...-...	0.5 - 4.0	31317207	30950283			

Cutting edge design			OA	OAA	OAA	
CCGW06 $a_p$ max. [mm]						
Finishing	CCGW060202F01N-...-...	0.1 - 1.0			31277730	
	CCGW060204F01N-...-...	0.1 - 1.0			30492177	
	CCGW060204E01N-...-...	0.1 - 1.0			10105520	
	CCGW060204E02N-...-...	0.2 - 1.0		30950284		
	CCGW060208E02N-...-...	0.2 - 1.0		30950285		
	CCGW09					
	CCGW09T304F01N-...-...	0.1 - 1.0			30418983	
	CCGW09T304E01N-...-...	0.1 - 1.0			10105634	
	CCGW09T304E02N-...-...	0.2 - 2.0		30950286		
	CCGW09T308F01N-...-...	0.1 - 1.0			30492178	
CCGW09T308E01N-...-...	0.1 - 1.0			10105648		
CCGW09T308E02N-...-...	0.2 - 2.0		30950287			

Specified  $a_p$  ranges are recommendations and can vary depending on the machined workpiece material.

# CCHT

Radial indexable inserts, double edge, left design



Workpiece material	K		N	
	Carbide		Carbide	
Substrate	CVD		PVD	
Coating	HC740		HP930	
Cutting material type	-		-	

Cutting edge design	1L	1L	1R	1R
---------------------	----	----	----	----

CCHT06		$a_p$ max. [mm]				
Medium machining	CCHT060202F01L-...-...	0.1 - 1.0		30010702		
	CCHT060204E04L-...-...	0.5 - 3.2	31041976	30950288		
	CCHT060204F01L-...-...	0.1 - 1.4		30010703		
	CCHT060208E04L-...-...	0.5 - 3.2	31115820	30950289		
	CCHT060208F01L-...-...	0.1 - 1.8		30010704		
	<b>CCHT09</b>					
	CCHT09T302F01L-...-...	0.5 - 4.0		30010705		
	CCHT09T304F01L-...-...	0.5 - 4.0		30010706	31414894	
	CCHT09T304E04L-...-...	0.5 - 4.0	30963744	30950290		
	CCHT09T308F01L-...-...	0.5 - 4.0		30010707	31357054	
	CCHT09T308E04L-...-...	0.5 - 4.0	30884324	30950291		
	CCHT09T312E04L-...-...	0.5 - 4.0	30884469	30950292		
	CCHT09T312F01L-...-...	0.1 - 2.0		30084580		
	<b>CCHT12</b>					
	CCHT120404E04L-...-...	0.5 - 5.0	30963715	30950293		
CCHT120404F01L-...-...	0.1 - 3.0		30010709			
CCHT120408E04L-...-...	0.5 - 5.0	30894700	30950294	31209761		
CCHT120408F01L-...-...	0.1 - 3.0		30010710			
CCHT120412E04L-...-...	0.5 - 5.0	31317213	30950295			

Cutting edge design		1L	1R	1R
---------------------	--	----	----	----

CCHT06		$a_p$ max. [mm]				
Finishing	CCHT060202F01L-...-...	0.1 - 1.0		30010702		
	CCHT060204F01L-...-...	0.1 - 1.4		30010703		
	CCHT060204E02L-...-...	0.1 - 1.0		30950296		
	CCHT060208F01L-...-...	0.1 - 1.8		30010704		
	CCHT060208E02L-...-...	0.1 - 1.0		30950297		
	<b>CCHT09</b>					
	CCHT09T302F01L-...-...	0.1 - 2.0		30010705		
	CCHT09T304F01L-...-...	0.1 - 2.0		30010706	31414894	
	CCHT09T304E02L-...-...	0.1 - 2.0		30950298		
	CCHT09T308F01L-...-...	0.1 - 2.0		30010707	31357054	
	CCHT09T308E02L-...-...	0.1 - 2.0		30950299		
	CCHT09T312F01L-...-...	0.1 - 2.0		30084580		
	<b>CCHT12</b>					
	CCHT120402F01L-...-...	0.1 - 3.0				
	CCHT120404F01L-...-...	0.1 - 3.0		30010709		
CCHT120408F01L-...-...	0.1 - 3.0		30010710	31209761		
CCHT120412F01L-...-...	0.1 - 3.0					

Specified  $a_p$  ranges are recommendations and can vary depending on the machined workpiece material.

# CCHT

Radial indexable inserts, double edge, right design



Workpiece material	K		N	
	Carbide		Carbide	
Substrate	CVD		PVD	
Coating	HC740		HP930	
Cutting material type	-		-	

Cutting edge design	1L	1L	1R	1R
---------------------	----	----	----	----

CCHT06		$a_p$ max. [mm]				
Medium machining	CCHT060202F01R-...-...	0.5 - 3.2			30010732	
	CCHT060204E04R-...-...	0.5 - 3.2	31317208	30950300		
	CCHT060204F01R-...-...	0.1 - 1.4			30010733	
	CCHT060208E04R-...-...	0.5 - 3.2	31317209	30950301		
	<b>CCHT09</b>					
	CCHT09T304F01R-...-...	0.5 - 4.0			30010736	31414870
	CCHT09T304E04R-...-...	0.5 - 4.0	31115392	30950302		
	CCHT09T308F01R-...-...	0.5 - 4.0			30010737	31414895
	CCHT09T308E04R-...-...	0.5 - 4.0	31041977	30950303		
	CCHT09T312E04R-...-...	0.5 - 4.0	31317210	30950304		
	CCHT09T312F01R-...-...	0.1 - 2.0			30492212	
	<b>CCHT12</b>					
	CCHT120404E04R-...-...	0.5 - 5.0	31317211	30950305		
	CCHT120404F01R-...-...	0.1 - 3.0			30010739	
	CCHT120408E04R-...-...	0.5 - 5.0	31317212	30950306		
	CCHT120408F01R-...-...	0.1 - 3.0			30010740	
CCHT120412E04R-...-...	0.5 - 5.0	31317214	30950307			

Cutting edge design		1L	1R	1R
---------------------	--	----	----	----

CCHT06		$a_p$ max. [mm]				
Finishing	CCHT060202F01R-...-...	0.1 - 1.0			30010732	
	CCHT060204F01R-...-...	0.1 - 1.4			30010733	
	CCHT060204E02R-...-...	0.1 - 1.0		30950308		
	CCHT060208F01R-...-...	0.1 - 1.8				
	CCHT060208E02R-...-...	0.1 - 1.0		30950309		
	<b>CCHT09</b>					
	CCHT09T302F01R-...-...	0.1 - 2.0				
	CCHT09T304F01R-...-...	0.1 - 2.0			30010736	31414870
	CCHT09T304E02R-...-...	0.1 - 2.0		30950310		
	CCHT09T308F01R-...-...	0.1 - 2.0			30010737	31414895
	CCHT09T308E02R-...-...	0.1 - 2.0		30950311		
	CCHT09T312F01R-...-...	0.1 - 2.0			30492212	
	<b>CCHT12</b>					
	CCHT120402F01R-...-...	0.1 - 3.0				
	CCHT120404F01R-...-...	0.1 - 3.0			30010739	
	CCHT120408F01R-...-...	0.1 - 3.0			30010740	
CCHT120412F01R-...-...	0.1 - 3.0					

Specified  $a_p$  ranges are recommendations and can vary depending on the machined workpiece material.

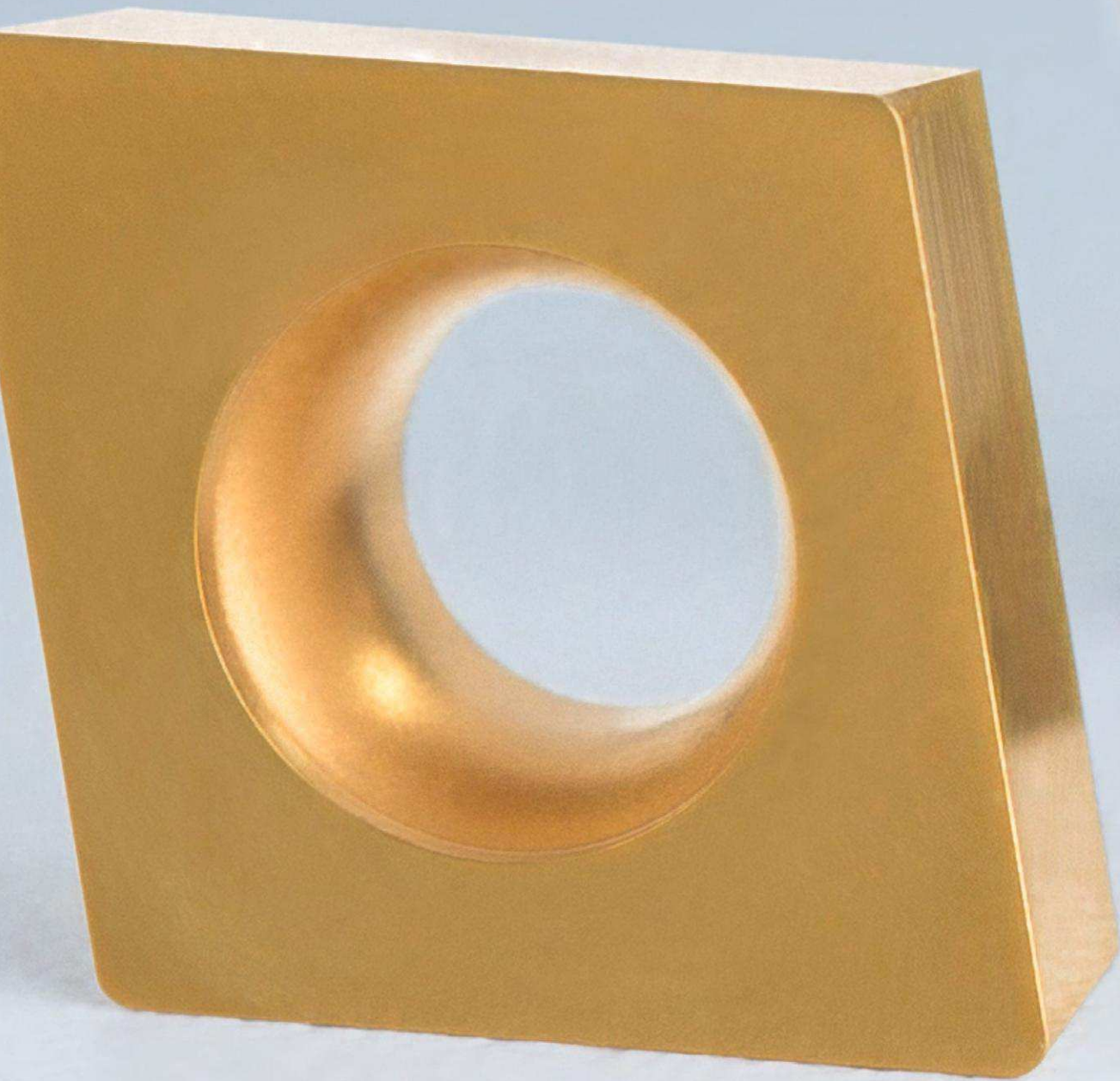

# SCMT | SPMT | SCGT | SPGT

Radial indexable insert,  
four-edge, neutral design



Workpiece material	P					
		← Unalloyed Wear-resistant		Alloyed Ductile →	← Unalloyed Wear-resistant	
Substrate	Cermet	Carbide				
Coating	CVD	CVD			PVD	
Cutting material type	CC112	HC850	HC855	HC865	HP880	HP895

Cutting edge design			MKM		MKM		
SCMT09		$a_p$ max. [mm]					
Roughing	SCMT09T308N-...-...	1.5 - 3.0	31265847		30966072		
		1.5 - 4.0					
	SCMT12	1.5 - 4.0	31265848		30985564		
		1.5 - 5.0					
	SCMT120412N-...-...	1.5 - 4.0	31265849				
		1.5 - 5.0					

Cutting edge design			MGP	MGP	MGP		MGP		
SPMT06		$a_p$ max. [mm]							
Medium machining	SPMT060304N-...-...	0.5 - 2.0	30985573		30985575				
	SPMT060308N-...-...	0.7 - 2.0			31265851				
	SCMT09	SCMT09T304N-...-...	0.5 - 3.0	31085129		31085141		30985536	
		SCMT09T308N-...-...	0.7 - 3.0	31085140	30985543	30966127			
		SCMT09T312N-...-...	1.0 - 3.0	31276723		31273621			
	SCGT09	SCGT09T308F01N-...-...	0.5 - 2.0						
		SCGT09T304N-...-...	0.1 - 2.0						
		SCGT09T308N-...-...	0.1 - 2.0						
	SCGT12	SCGT09T304N-...-...	0.5 - 3.0						
		SCGT09T308N-...-...	0.5 - 3.0						
	SCMT12	SCGT120408N-...-...	0.5 - 4.0						
		SCMT12	SCMT120404N-...-...	0.5 - 3.0					
			SCMT120408N-...-...	0.7 - 3.0	31085142	30985560	31085143		

Specified  $a_p$  ranges are recommendations and can vary depending on the machined workpiece material.

Tipped variants,  
single-edge:

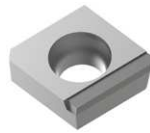

6LA

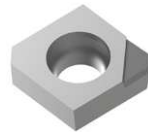

5LA



C1A



C2A

M				K		N			X	
Austenitic Wear-resistant		Ferritic Ductile	Austenitic Wear-resistant		Ferritic Ductile	GJL Wear-resistant		GJS Ductile	Al alloyed Wear-resistant	Cu alloyed Ductile
Carbide						PCD			Carbide	
CVD		PVD				-			-	
HC875	HC885	HP880	HP895	HC820	HC830	HU816	PU617	PU670	HP531	
				MKM	MKM					
					30985545	31092659				
					30985562	31092660				
					30985566	31092661				
	MGP			MGP	MGP	MGP	MAL		C2A	M41
					30985574	30985576				
					30985914	30985915				
	30985535			30985536	30985908	30985534				
	31092662				30985911	30985912				
									30249457	
										31370424
										31065010
							31488953			
							31488955			
							31488956			
					30985552	30985554				
	30985559				30985556	30985558				

# SCMT | SPMT | SCGT | SPGT

Radial indexable insert,  
four-edge, neutral design



Workpiece material	P					
		← Unalloyed Wear-resistant		Alloyed Ductile →	← Unalloyed Wear-resistant	
Substrate	Cermet	Carbide				
Coating	CVD	CVD			PVD	
Cutting material type	CC112	HC850	HC855	HC865	HP880	HP895

Cutting edge design		U19	MMM	MMM	MMM	MMM		
<b>SPMT06</b>		<b>a<sub>p</sub> max. [mm]</b>						
Finishing	SPMT060304N-...-...	0.5 - 2.0	30985579		30985580	30985577	30985913	
	<b>SPGT06</b>							
	SPGT060304F01N-...-...	0.1 - 0.8						
	SPGT060304F01L-...-...	0.1 - 3.0						
	SPGT060304F01R-...-...	0.1 - 3.0						
	SPGT060308F01N-...-...	0.1 - 0.8						
	SPGT060308F01L-...-...	0.1 - 3.0						
	SPGT060308F01R-...-...	0.1 - 3.0						
	<b>SCMT09</b>							
	SCMT09T304N-...-...	0.5 - 1.5		31085144		31085145		30985540
	SCMT09T308N-...-...	0.5 - 1.5		30983531		30966073	30966076	30955704
	<b>SCGT09</b>							
	SCGT09T304N-...-...	0.1 - 0.5	30647885					
	SCGT09T304F01N-...-...	0.1 - 0.5						
	SCGT09T304F01L-...-...	0.1 - 4.5						
SCGT09T304F01R-...-...	0.1 - 4.5							
SCGT09T308N-...-...	0.1 - 0.5	10102893						
SCGT09T308F01N-...-...	0.1 - 0.5							
SCGT09T308F01N-...-...	0.1 - 1.4							
SCGT09T308F01L-...-...	0.1 - 4.5							
SCGT09T308F01R-...-...	0.1 - 4.5							

Specified ap ranges are recommendations and can vary depending on the machined workpiece material.



Tipped variants, single-edge:

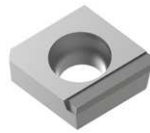

6LA

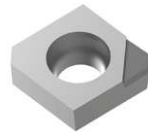

5LA



C1A



C2A

M				K		N			X
Austenitic Wear-resistant	Ferritic Ductile	Austenitic Wear-resistant	Ferritic Ductile	GJL Wear-resistant	GJS Ductile	Al alloyed Wear-resistant		Cu alloyed Ductile	
Carbide						PCD			Carbide
CVD		PVD				-			-
HC875	HC885	HP880	HP895	HC820	HC830	HU816	PU617	PU670	HP531
	MMM	MMM	MMM	MMM	MMM	MAL	5LA	6LA	C2A
									M41
	30972033	30985577	30985913	30985578	31084646				
							31277727		
								30373268	
								31279699	
							31279698		
								31217111	
								31279720	
			30985540	30985538	30985539				
		30966076	30955704	30985548	30985550				
									31370424
							30374908		
								30546951	
								31279721	
									31065010
							30692832		
									30250261
								30568596	
								31279723	

# SCGW | SPGW

Radial indexable inserts, four cutting edges



Tipped variants,  
single-edge:

OAA

Workpiece material	K			N
	Carbide		PcBN	PCD
Substrate	Carbide		PcBN	PCD
Coating	CVD	PVD	-	-
Cutting material type	HC740	HP930	FU430	PU617

Cutting edge design		OA	OA	OAA	
<b>SPGW06</b> $a_p$ max. [mm]					
Medium machining	SPGW060304E04N-...-...	0.5 - 3.2	31070945	30950312	
	SPGW060308E04N-...-...	0.5 - 3.2	31050739	30950313	
	<b>SCGW09</b>				
	SCGW09T304E04N-...-...	0.5 - 4.0	31022296	30950314	
	SCGW09T304T51N-...-...	0.5 - 2.5		10106285	
	SCGW09T308E04N-...-...	0.5 - 4.0	31022297	30950315	
	SCGW09T308T51N-...-...	0.5 - 2.5		10106299	
	<b>SCGW12</b>				
	SCGW120404E04N-...-...	0.5 - 5.0	31317220	30950316	
	SCGW120408E04N-...-...	0.5 - 5.0	30939413	30950317	

Cutting edge design			OA	OAA	OAA
<b>SPGW06</b> $a_p$ max. [mm]					
Finishing	SPGW060304F01N-...-...	0.1 - 1.2			31277731
	SPGW060304E02N-...-...	0.2 - 1.0		30950318	
	SPGW060308F01N-...-...	0.1 - 1.0			31279738
	SPGW060308E02N-...-...	0.2 - 1.0		30950319	
	<b>SCGW09</b>				
	SCGW09T304F01N-...-...	0.1 - 1.4			31277732
	SCGW09T304E01N-...-...	0.1 - 1.0		10106283	
	SCGW09T304E02N-...-...	0.2 - 2.0		30950320	
	SCGW09T308F01N-...-...	0.1 - 1.8			30429723
	SCGW09T308E01N-...-...	0.1 - 1.0		10106297	
	SCGW09T308E02N-...-...	0.2 - 2.0		30950321	
	<b>SCGW12</b>				
	SCGW120404F01N-...-...	0.1 - 1.4			31279752
SCGW120408F01N-...-...	0.1 - 1.8			31279753	

# SCHT | SPHT

Radial indexable inserts, double edge, neutral design



Workpiece material	K		N	
	Carbide		Carbide	
Substrate	CVD		PVD	-
Coating	HC740		HP930	HU616
Cutting material type	1L		1L	1R
Medium machining	Cutting edge design		1L	
	SPHT06 $a_p$ max. [mm]		1L	
	SPHT060304E04X-...-...	0.5 - 3.2	31042317	30953122
	SPHT060308E04X-...-...	0.5 - 3.2	31317315	30953126
	SPHT060304F01X-1R-...-...	0.5 - 3.2		30010680
	SCHT09		1L	
	SCHT09T304E04X-...-...	0.5 - 4.0	31121604	30953127
	SCHT09T304F01X-...-...	0.1 - 2.0		30010681
	SCHT09T308E04X-...-...	0.5 - 4.0	30963756	30953128
	SCHT09T308F01X-...-...	0.1 - 2.0		30010682
	SCHT09T312E04X-...-...	0.5 - 4.0	31317219	30953150
	SCHT12		1L	
	SCHT120404E04X-...-...	0.5 - 5.0	31081857	30953151
	SCHT120408E04X-...-...	0.5 - 5.0	31317304	30953152
	SCHT120408F01X-...-...	0.1 - 3.0		30010684
SCHT120412E04X-...-...	0.5 - 5.0	31317308	30953154	
Finishing	Cutting edge design		1L	
	SPHT06 $a_p$ max. [mm]		1R	
	SPHT060304F01X-1R-...-...	0.1 - 1.0		30010680
	SPHT060304E02X-...-...	0.1 - 1.0	30953158	
	SPHT060308E02X-...-...	0.1 - 1.0	30953164	
	SCHT09		1L	
	SCHT09T302F01X-...-...	0.1 - 2.0		
	SCHT09T304F01X-...-...	0.1 - 2.0		30010681
	SCHT09T304E02X-...-...	0.1 - 2.0	30953159	
	SCHT09T308F01X-...-...	0.1 - 2.0		30010682
	SCHT09T308E02X-...-...	0.1 - 2.0	30953168	
	SCHT09T312F01X-...-...	0.1 - 2.0		
SCHT12		1L		
SCHT120404F01X-...-...	0.1 - 3.0			
SCHT120408F01X-...-...	0.1 - 3.0		30010684	

Specified  $a_p$  ranges are recommendations and can vary depending on the machined workpiece material.

# SCHT | SPHT

Radial indexable inserts, four cutting edges



Left design

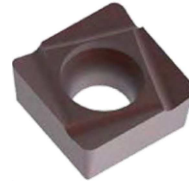

Right design

Next table:  
**Finishing**

Workpiece material	K		N		
	Carbide		Carbide		
Substrate	CVD		PVD		
Coating	HC740		HP930		
Cutting material type	-		HU616		
Cutting edge design	2L		2R		
SPHT06	$a_p$ max. [mm]				
SPHT060302F01L-...-...	0.5 - 3.2				
SPHT060302F01R-...-...	0.5 - 3.2				
SPHT060304F01L-...-...	0.5 - 3.2			31414892	
SPHT060304F01R-...-...	0.5 - 3.2			31414883	
SPHT060304E04L-...-...	0.5 - 3.2	31044035	30950322		
SPHT060304E04R-...-...	0.5 - 3.2	30939004	30950346		
SPHT060308F01L-...-...	0.5 - 3.2				
SPHT060308F01R-...-...	0.5 - 3.2				
SPHT060308E04L-...-...	0.5 - 3.2	31317311	30950323		
SPHT060308E04R-...-...	0.5 - 3.2	31317314	30950347		
<b>SCHT09</b>					
Medium machining	SCHT09T304F01L-...-...	0.5 - 4.0			31414889
	SCHT09T304F01R-...-...	0.5 - 4.0			31414884
	SCHT09T304E04L-...-...	0.5 - 4.0	31043583	30950324	
	SCHT09T304E04R-...-...	0.5 - 4.0	30812298	30950348	
	SCHT09T308F01L-...-...	0.5 - 4.0			31414874
	SCHT09T308F01R-...-...	0.5 - 4.0			31414879
	SCHT09T308E04L-...-...	0.5 - 4.0	31039585	30950325	
	SCHT09T308E04R-...-...	0.5 - 4.0	31317215	30950349	
	SCHT09T312E04L-...-...	0.5 - 4.0	31317216	30950326	
	SCHT09T312E04R-...-...	0.5 - 4.0	31317217	30950350	
	<b>SCHT12</b>				
	SCHT120404E04L-...-...	0.5 - 5.0	31317284	30950327	
SCHT120404E04R-...-...	0.5 - 5.0	31317287	30950351		
SCHT120408E04L-...-...	0.5 - 5.0	31317300	30950328		
SCHT120408E04R-...-...	0.5 - 5.0	31317301	30950352		
SCHT120412E04L-...-...	0.5 - 5.0	31317305	30950329		
SCHT120412E04R-...-...	0.5 - 5.0	31317307	30950353		

# SCHT | SPHT

Radial indexable inserts, four cutting edges



Left design

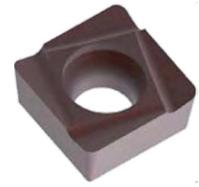

Right design

Workpiece material	<b>K</b>	<b>N</b>	
		Al alloyed ← Wear-resistant	Cu alloyed → Ductile
Substrate	Carbide		Carbide
Coating	PVD		PVD
Cutting material type	HP930		HP616

Cutting edge design	2L	2R	2R
---------------------	----	----	----

SPHT06		$a_p$ max. [mm]			
Finishing	SPHT060302F01L-...-...	0.1 - 1.0			
	SPHT060302F01R-...-...	0.1 - 1.0			
	SPHT060304F01L-...-...	0.1 - 1.0		30010644	
	SPHT060304F01R-...-...	0.1 - 1.0		30010662	
	SPHT060304E02L-...-...	0.1 - 1.0	30950330		
	SPHT060304E02R-...-...	0.1 - 1.0	30950354		
	SPHT060308F01L-...-...	0.1 - 1.0			
	SPHT060308F01R-...-...	0.1 - 1.0			
	SPHT060308E02L-...-...	0.1 - 1.0	30950331		
	SPHT060308E02R-...-...	0.1 - 1.0	30950355		
	SCHT09				
	SCHT09T304F01L-...-...	0.1 - 2.0		30010645	
	SCHT09T304F01R-...-...	0.1 - 2.0		30010663	
	SCHT09T304E02L-...-...	0.1 - 2.0	30950332		
SCHT09T304E02R-...-...	0.1 - 2.0	30950356			
SCHT09T308F01L-...-...	0.1 - 2.0		30010646		
SCHT09T308F01R-...-...	0.1 - 2.0		30010664		
SCHT09T308E02L-...-...	0.1 - 2.0	30950333			
SCHT09T308E02R-...-...	0.1 - 2.0	30950357			

Specified  $a_p$  ranges are recommendations and can vary depending on the machined workpiece material.

# CTHQ

Tangential indexable inserts, four cutting edges, without arc shaped land



Left design



Right design

Workpiece material	P		M <sub>1</sub>	M <sub>2</sub>		M <sub>2</sub>	
				Unalloyed Wear-resistant	Alloyed Ductile		
Substrate	Carbide		Carbide	Carbide		Carbide	
Coating	CVD	PVD	CVD	CVD		PVD	
Cutting material type	HC740	HP945	HC750	HC740	HC750	HP945	

Cutting edge design								
CTHQ from ø 28 mm a <sub>p</sub> max. [mm]								
Roughing	CTHQ060408...L-...	1.5 - 2.5						
	CTHQ060408...R-...	1.5 - 2.5						
	Cutting edge design				A32	H02	H02	H02
	CTHQ from ø 41 mm a <sub>p</sub> max. [mm]							
	CTHQ090508...L-...	1.5 - 3.0			30950084	30980629	30980631	30980632
		1.5 - 4.0						
	CTHQ090508...R-...	1.5 - 3.0			30950086	30980712	30980714	30980751
		1.5 - 4.0						
	CTHQ from ø 54 mm							
	CTHQ120608...L-...	1.5 - 3.0				30980759	30980765	30980766
1.5 - 5.0								
CTHQ120608...R-...	1.5 - 3.0				30980784	30980786	30980787	
	1.5 - 5.0							

Cutting edge design		A32	A32		A32	A32	A32	
CTHQ from ø 28 mm a <sub>p</sub> max. [mm]								
Medium machining	CTHQ060404...L-...	0.5 - 2.0						
	CTHQ060404...R-...	0.5 - 2.0						
	CTHQ from ø 41 mm							
	CTHQ090504...L-...	0.5 - 2.0	30933878	30933880		30933878	30980967	30933880
	CTHQ090504...R-...	0.5 - 2.0					30980968	
	CTHQ090508...L-...	0.5 - 2.0	30813598	30933885		30813598	30950084	30933885
	CTHQ090508...R-...	0.5 - 2.0					30950086	
	CTHQ from ø 54 mm							
	CTHQ120604...L-...	0.5 - 2.0	30933904			30933904		
CTHQ120604...R-...	0.5 - 2.0	30980051			30980051			

M<sub>1</sub> Stainless steel

M<sub>2</sub> Heat-resistant cast steel (turbocharger materials)

Specified a<sub>p</sub> ranges are recommendations and can vary depending on the machined workpiece material.



Tipped variants,  
single-edge:

A79, A80

K				N		
GJL ← Wear-resistant		GJS → Ductile		GJL ← Wear-resistant		GJS → Ductile
CVD				Carbide		PCD
CVD		PVD		-	PVD	-
HC725	HC740	HP930	HP945	HU616	HP616	PU617
H32	H32	H32	H32			
30933907	30980615	30933910	30980618			
30933912	30980621		30980625			
H02	H02	H02	H02			A80
30921024	30980629	30933917	30980632			30492720
30921023	30980712	30933923	30980751			30515656
30933946	30980759	30933949	30980766			
30933951	30980784	30933954	30980787			
A32	A32	A32	A32	A30	A30	A80
30679873	30942364		30942366	30477914	30492747	
					30477914	
30679874	30933878	30933979	30933880	30492760	31414873	30492764
30679875		30942374		30492770		30515411
30724676	30813598	30933994	30933885	31186236	31414888	
30789885		30942382		31264530	31414876	
30789886	30933904	30934028		30477929		
30789887	30980051	30980054		30477930		

Specified ap ranges are recommendations and can vary depending on the machined workpiece material.

# FTHQ

Tangential indexable inserts, four cutting edges, without arc shaped land



Workpiece material	P		M <sub>1</sub>			Austenitic Wear-resistant	Ferritic Ductile		
	Carbide		Carbide						
Substrate	CVD		PVD		CVD			PVD	
Coating	CVD		PVD		CVD			PVD	
Cutting material type	HC740		HP945		HC750			HC740	HC750

Cutting edge design		A53	A53	A32	H02	H02		
FTHQ from ø 30 mm		a <sub>p</sub> max. [mm]						
Roughing	FTHQ090508...L-...	1.5 - 3.0	30980167	30934159	30934160	30912756	30980484	
		1.5 - 4.0						
	FTHQ090508...R-...	1.5 - 3.0	30934166	30934167	30950130	30980488		
		1.5 - 4.0						
	FTHQ from ø 40 mm							
	FTHQ120608...L-...	1.5 - 3.0	30934177	30934178	30934179	30980491	30980493	
	1.5 - 5.0							
FTHQ120608...R-...	1.5 - 3.0	30934185	30934186	30950135	30980501			
	1.5 - 5.0							

Cutting edge design		A32	A32		A32	A32		
FTHQ from ø 22 mm		a <sub>p</sub> max. [mm]						
Medium machining	FTHQ060404...L-...	0.5 - 1.5						
	FTHQ060404...R-...	0.5 - 1.5						
	FTHQ060408...L-...	0.5 - 1.5						
	FTHQ060408...R-...	0.5 - 1.5						
	FTHQ from ø 30 mm							
	FTHQ090504...L-...	0.5 - 2.0						
	FTHQ090504...R-...	0.5 - 2.0						
	FTHQ090508...L-...	0.5 - 2.0	30934214	30934215		30934214	30934160	
	FTHQ090508...R-...	0.5 - 2.0					30950130	
	FTHQ from ø 40 mm							
	FTHQ120604...L-...	0.5 - 2.0						
	FTHQ120604...R-...	0.5 - 2.0						
FTHQ120608...L-...	0.5 - 2.0	30934231	30934232		30934231	30934179		
FTHQ120608...R-...	0.5 - 2.0					30950135		

M<sub>1</sub> Stainless steel

M<sub>2</sub> Heat-resistant cast steel (turbocharger materials)

Specified a<sub>p</sub> ranges are recommendations and can vary depending on the machined workpiece material.







# MILLING

---

Solid carbide and PCD end milling cutter for machining titanium, stainless steel and aluminium. PCD face milling cutter for the highest surface finishes in aluminium. NeoMill product range additions.





Step 1:  
Type of milling cutter



Step 2:  
Design



Step 3:  
Product category



Step 4:  
Material suitability



Step 5:  
Application

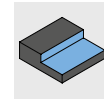

Step 6:  
Design



Edge design			Design				Product			Catalogue	
45°	90°	CR	ø [mm]	z	Mat.		Product name	Specification		Main catalogue	Page
✓		✓	2,5-25	4	HP		OptiMill-Uni-HPC-Plus	SCM720,740,760,770		✓	
✓			1-20	2	HP		OptiMill-Uni-HPC-Plus	SCM772		✓	
✓	✓		1-20	3	HP		OptiMill-Uni-HPC-Slot	SCM250		✓	
		✓	3,8-20	3	HP		OptiMill-Uni-HPC-Pocket	SCM800,810,840		✓	
✓			6-25	5	HP		OptiMill-Uni-HPC-Silent	SCM570		✓	
		✓	4-20	4	HP		OptiMill-Hardened	SCM102,103		✓	
✓			3-20	4	HP		OptiMill-Inox-HPC	SCM108		✓	
		✓	6-25	4	HP		OptiMill-Titan-HPC	<span style="background-color: yellow; border: 1px solid black; border-radius: 50%; padding: 2px;">N</span> SCM394			110
✓			3-20	3	HU		OptiMill-Alu-HPC	SCM270		✓	
		✓	5-20	3	HP		OptiMill-Alu-HPC-Pocket	SCM850		✓	
		✓	5-20	4	HP		OptiMill-Alu-HPC-Pocket	SCM854		✓	
✓			4-5	1	PU		OptiMill-Diamond-Typ 50	<span style="background-color: blue; color: white; border-radius: 50%; padding: 2px;">+</span> SHM500			98
✓			3-12	2	PU	✓	OptiMill-Diamond-Typ 51	<span style="background-color: blue; color: white; border-radius: 50%; padding: 2px;">+</span> SHM511,611,711			99
		✓	6-20	2-3	PU	✓	OptiMill-Diamond-Typ 53	<span style="background-color: blue; color: white; border-radius: 50%; padding: 2px;">+</span> SHM531			100
✓			16-63	3-4	PU	✓	OptiMill-Diamond-Typ 57	SHM571		✓	
✓			6-20	4	HC		OptiMill-Thermoplastic-FR	SCM610		✓	
✓			4-20	8	HU		OptiMill-Composite-Speed-Plus	SCM982, 992		✓	
	✓		1-3	MT	HC		OptiMill-Composite-Micro	SCM560		✓	
	✓		4-20	2	HU		OptiMill-Composite-TwinCut	SCM490		✓	
		✓	12-32	3	HU	✓	OptiMill-SPM	SCM681,691		✓	
		✓	6-50	3	PU	✓	OptiMill-Diamond-SPM	SHM101,110,111,121		✓	
✓			4-20	8	HC		OptiMill-Composite-Speed-Plus	SCM980, 990		✓	
✓			3-20	4	HP		ECU-Mill-Uni-LV	SCM780,790		✓	
	✓	✓	2-10	1	HU		OptiMill-Mono-Alu	SCM280		✓	
	✓		2-12	1	HU		OptiMill-Mono-Plastic	SCM330		✓	

Additional shoulder milling cutters for universal application on the next page.

HP = carbide PVD-coated | HU = carbide uncoated  
 HC = carbide CVD-coated | PU = PCD-tipped | VZ = multi-tooth

N New

+ Range additions



# Shoulder milling cutter- universal application (2/2)

Design	Product category	Material suitability																		Application																	
		P						M	K	N				C		S	H			Application icons																	
		1-3	4	5	6	1-3	1-3	1	2	3	4	1	2	1-5	1	2	3																				
Performance LINE	Icon 1	■	■	■	■	■																		■	■	■								■			
	Icon 2	■	■	■	■	■																			■	■	■									■	



# Shoulder milling cutter – roughing

Design	Product category	Material suitability																		Application																							
		P						M	K	N				C		S	H			Application icons																							
		1-3	4	5	6	1-3	1-3	1	2	3	4	1	2	1-5	1	2	3																										
Performance LINE	Icon 1	■	■	■	■	■																		★	■	■									■	■	■						
	Icon 2	■	■	■	■	■																			★	■	■									★	■	■					
Basic LINE	Icon 3	■	■	■	■	■				■															■	■	■											■	■	■			
	Icon 4	■	■	■	■	■				■															■	■	■												■	■	■		

Step 1:  
Type of milling cutter



Step 2:  
Design



Step 3:  
Product category



Step 4:  
Material suitability



Step 5:  
Application

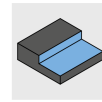

Step 6:  
Design



Edge design		Design				Product			Catalogue		
45°	90°	CR	ø [mm]	z	Mat.	+	Product name	Specification	Image	Main catalogue	Page
✓			8-20	4	HP		CPMill-Uni-HPC	CPM100		✓	
✓			8-25	3	HP		CPMill-Uni-HPC-Slot	CPM110		✓	

Edge design		Design				Product			Catalogue		
45°	90°	CR	ø [mm]	z	Mat.	+	Product name	Specification	Image	Main catalogue	Page
✓			4-25	3-5	HP		OptiMill-Uni-HPC-Rough	SCM700, 710		✓	
✓			4-25	5	HP	✓	OptiMill-Uni-Wave	SCM880,881, 890,900,910		✓	
✓		✓	12-25	3	HP	✓	OptiMill-Alu-Wave <span style="color: green; font-weight: bold;">N</span>	SCM109			92
✓	✓		6-20	3-4	HP		ECU-Mill-Uni-Rough&Finish	SCM220		✓	
✓			8-25	4-6	HP		CPMill-Uni-Rough&Finish	CPM140		✓	

HP = carbide PVD-coated | HU = carbide uncoated  
 HC = carbide CVD-coated | PU = PCD-tipped | VZ = multi-tooth

N New

+ Range additions



## Shoulder milling cutter – finishing

Design	Product category	Material suitability													Application														
		P			M	K	N				C		S	H			Application												
		1-3	4	5	6	1-3	1-3	1	2	3	4	2	4	1-5	1	2	3												
	Performance LINE	■	■	■	■	■	■								■	■													
		■	■	■	■	■	■																						
	Performance LINE	■	■	■	■	■	■								■														



## Shoulder milling cutter – trochoidal milling

Design	Product category	Material suitability													Application																
		P			M	K	N				C		S	H			Application														
		1-3	4	5	6	1-3	1-3	1	2	3	4	2	4	1-5	1	2	3														
	Expert LINE	■	■	■	■	■	■																			■	■	★		■	
		■	■	■	■	■	■																				■	■	★		■
		■	■	■	■	■	■																				■	■	★		■
																											■	■	★		■
																											■	■	★		■
																											■	■	★		■
																											■	■	★		■



Step 1:  
Type of milling cutter



Step 2:  
Design



Step 3:  
Product category



Step 4:  
Material suitability



Step 5:  
Application

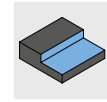

Step 6:  
Design



Edge design			Design				Product			Catalogue	
45°	90°	CR	∅ [mm]	z	Mat.		Product name	Specification		Main catalogue	Page
✓	✓		4-25	7	HP		OptiMill-Uni-HPC-Finish	SCM830		✓	
	✓		6-20	6	HP		OptiMill-Uni-HPC-Finish	SCM370		✓	
	✓	✓	4-25	6	HP		OptiMill-Hardened-Finish	SCM104,124		✓	
		✓	12-25	4	HU		OptiMill-SPM-Finish	SCM970		✓	
	✓		8-25	6	HP		CPMill-Uni-HPC-Finish	CPM130		✓	

Edge design			Design				Product			Catalogue	
45°	90°	CR	∅ [mm]	z	Mat.		Product name	Specification		Main catalogue	Page
✓			4-20	5	HP		OptiMill-Tro-Uni	SCM580, 940		✓	
✓			4-25	5	HP		OptiMill-Tro-PM	SCM590		✓	
✓			4-25	7	HP		OptiMill-Tro-PM	SCM820, 930		✓	
✓			4-25	6	HP		OptiMill-Tro-Inox <span style="background-color: yellow; border-radius: 50%; padding: 2px;">N</span>	SCM292			104
		✓	6-25	5	HP		OptiMill-Tro-Titan	SCM630		✓	
		✓	6-25	5	HP		OptiMill-Tro-S	SCM600		✓	
		✓	6-25	5	HP		OptiMill-Tro-H	SCM920		✓	

HP = carbide PVD-coated | HU = carbide uncoated  
 HC = carbide CVD-coated | PU = PCD-tipped | VZ = multi-tooth

N New

+ Range additions

## High-feed milling cutter

Design	Product category	Material suitability														Application																	
		P						M	K	N				C		S	H			Application icons													
		1-3	4	5	6	1-3	1-3	1	2	3	4	1	2	1-5	1	2	3																
		■	■	■	■	■	■									■	■									★							
																■	■	■									★						
		■	■	■	■	■	■																			★							

## Ball and corner radius milling cutter

Design	Product category	Material suitability														Application																			
		P						M	K	N				C		S	H			Application icons															
		1-3	4	5	6	1-3	1-3	1	2	3	4	1	2	1-5	1	2	3																		
		■	■	■	■	■	■									■	■					★													
																■	■	■					★												
											■	■	■					■	■	■	■	★													
											■	■	■					■	■	■	■	★								■					
		■	■	■	■	■	■															■													
		■	■	■	■	■	■															■													

## Chamfering, deburring and drill milling cutters

Design	Product category	Material suitability														Application																			
		P						M	K	N				C		S	H			Application icons															
		1-3	4	5	6	1-3	1-3	1	2	3	4	1	2	1-5	1	2	3																		
		■	■	■	■	■	■														★														
		■	■	■	■	■	■														■									■					
		■	■	■	■	■	■														★														
		■	■	■	■	■	■														■														

★ 1st choice   ■ highly suitable   ■ suitable in some situations

Step 1:  
Type of milling cutter



Step 2:  
Design



Step 3:  
Product category



Step 4:  
Material suitability



Step 5:  
Application

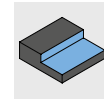

Step 6:  
Design



Edge design			Design				Product			Catalogue	
45°	90°	CR	∅ [mm]	z	Mat.		Product name	Specification		Main catalogue	Page
			3-16	4	HP		OptiMill-3D-HF	MHF101		✓	
			2-16	4	HP		OptiMill-3D-HF-Hardened	MHF102		✓	
			8-25	6		✓	CPMill-Uni-FeedPlus	CPM171		✓	

Edge design			Design				Product			Catalogue	
45°	90°	CR	∅ [mm]	z	Mat.		Product name	Specification		Main catalogue	Page
			1-12	2	HP		OptiMill-3D-BN	MBN101		✓	
			3-12	2	HP		OptiMill-3D-BN-Hardened	MBN107		✓	
			4-20	8	HC		OptiMill-Composite-Speed-Radius	SCM870		✓	
			3-16	2	PU	✓	OptiMill-Diamond-Radius	SHM521			101
		✓	3-12	2	PU	✓	OptiMill-Diamond-Torus	SHM551			102
			8-25	4	HP		CPMill-Uni-Radius	CPM150		✓	
		✓	8-25	4	HP		CPMill-Uni-Torus	CPM160		✓	

Edge design			Design				Product			Catalogue	
45°	90°	CR	∅ [mm]	z	Mat.		Product name	Specification		Main catalogue	Page
			4-20	4	HP		OptiMill-Chamfer	SCM340		✓	
			3-16	2	HU		OptiMill-DrillMill	SCM350		✓	
			8-20	4/6	HP		CPMill-Chamfer	CPM180		✓	
	✓		10-20	3+3	HP		CPMill-Chamfer-Twin	CPM190		✓	

HP = carbide PVD-coated | HU = carbide uncoated  
 HC = carbide CVD-coated | PU = PCD-tipped | VZ = multi-tooth

New

Range additions

# OptiMill®-Alu-Wave

## A new dimension of high-volume aluminium machining

The OptiMill-Alu-Wave is a newly developed roughing cutter for machining aluminium materials. It produces short chips and ensures smooth cutting behaviour thanks to its unique cord roughing geometry. The milling cutter has a central cooling channel that minimises the formation of built-up edges and safely removes chips. It also offers configurable corner radii for precise near-contour roughing. Due to its high machining volume, the OptiMill-Alu-Wave allows efficient material removal and, in this way, increases productivity. Available in various lengths, it adapts perfectly to the individual requirements of any roughing task.

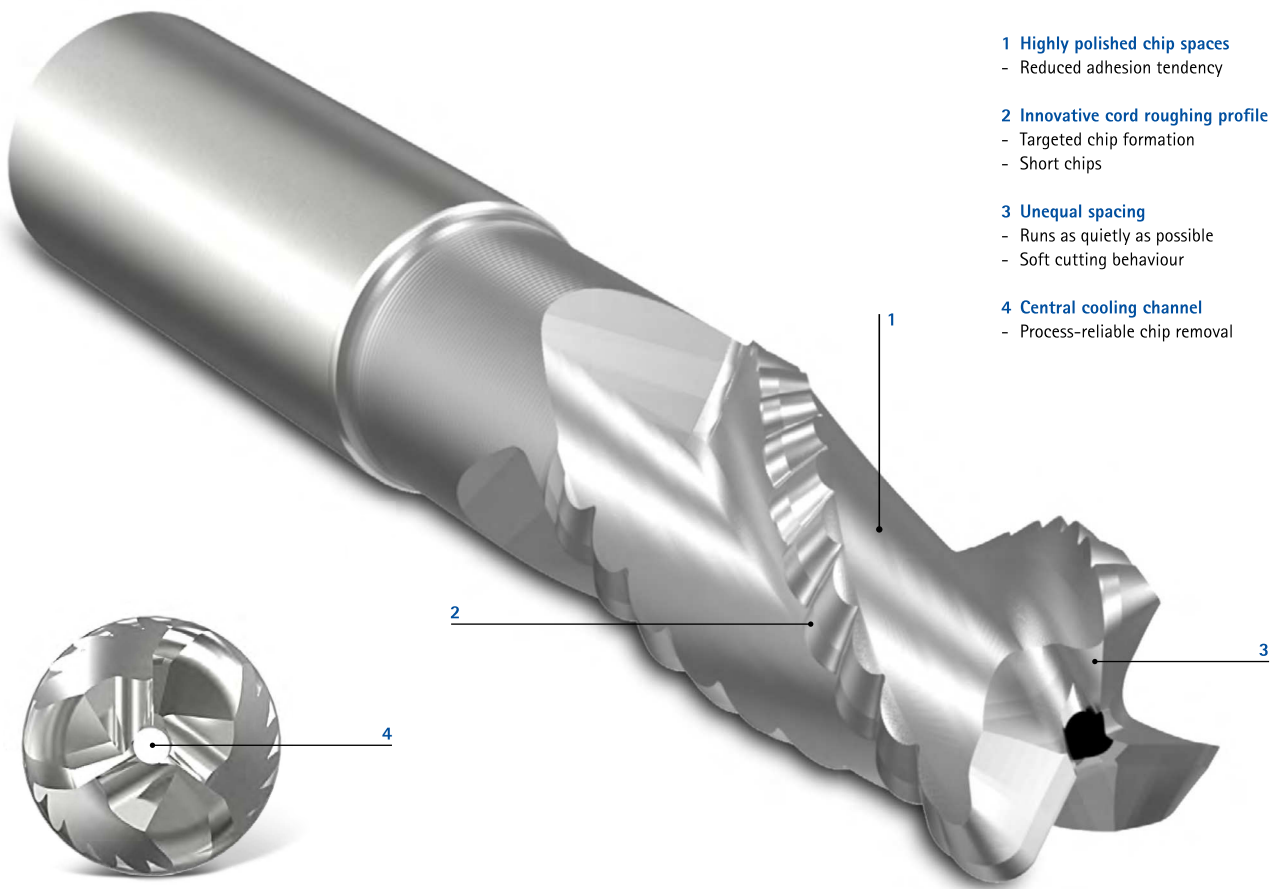

- 1 Highly polished chip spaces**
  - Reduced adhesion tendency
- 2 Innovative cord roughing profile**
  - Targeted chip formation
  - Short chips
- 3 Unequal spacing**
  - Runs as quietly as possible
  - Soft cutting behaviour
- 4 Central cooling channel**
  - Process-reliable chip removal

### Features

**Preferred series available from stock**

- Designs: long, over-long, extra-long projection length with neck
- Ø area: 12.00 - 25.00 mm
- Shank form: HA

**Configurable features:**

- Ø area: 12.00 - 25.00 mm
- Shank form: HB | SL (Safe-lock®)
- Cutting edge design: Radius | Chamfer 45° of Ø 12.00 - 25.00 mm | 0.40 - 1.00 mm
- Coating: Available as DLC coating with cutting material HP910

### Material removal rate [dm³/min]

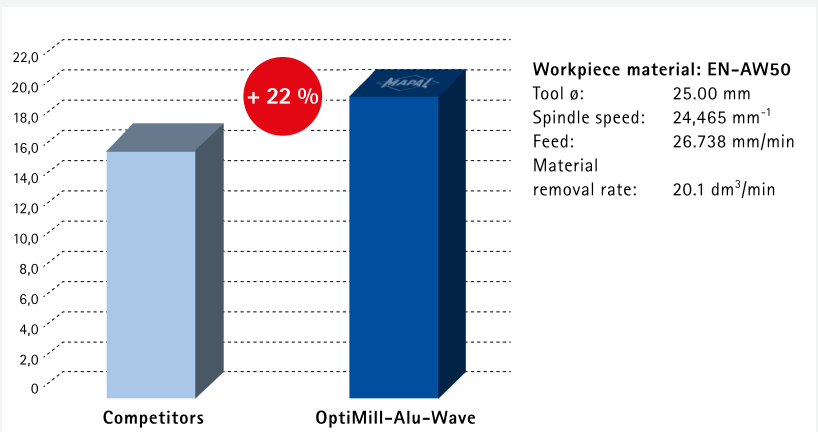

# OptiMill®-Alu-Wave

Shoulder milling cutter, long projection length with neck, with internal coolant supply  
SCM109

**Design:**

Diameter of milling cutter: 12.00 - 25.00 mm  
Cutting material: HU318  
Number of cutting edges: 3  
Helix angle: 36°

**Application:**

Before using in the machine, check the cutting data according to machine performance (see cutting data).

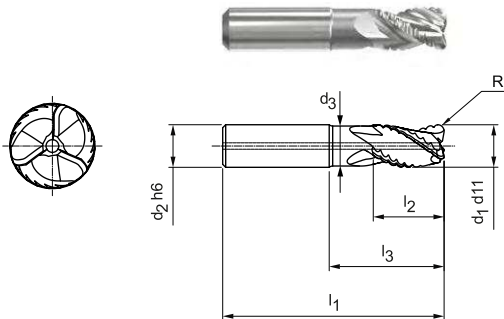

N	1.1	1.2	1.3	1.4	2.1	2.2	2.3	3.1	3.2	4.1	4.2	4.3	C	1.1	1.2	1.3	2.1	3.1	4.1	4.2	5.1	5.2	5.3
---	-----	-----	-----	-----	-----	-----	-----	-----	-----	-----	-----	-----	---	-----	-----	-----	-----	-----	-----	-----	-----	-----	-----

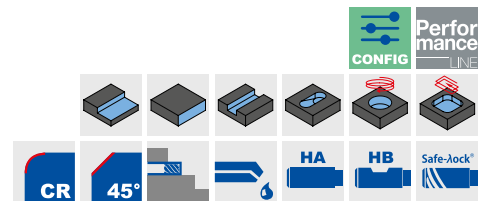

**Preferred series available from stock | Long projection length**

Dimensions							z	Specification	Order no.
d1 d11	d2 h6	d3	l1	l2	l3	R			
12,00	12	11,2	83	22	36	2,00	3	SCM109-1200Z03R-R0200HA-HU318	31430821
16,00	16	15,1	92	26	42	3,00	3	SCM109-1600Z03R-R0300HA-HU318	31430824
20,00	20	18,8	104	32	54	3,00	3	SCM109-2000Z03R-R0300HA-HU318	31430827
20,00	20	18,8	104	32	54	4,00	3	SCM109-2000Z03R-R0400HA-HU318	31430828
25,00	25	23,5	114	40	58	3,00	3	SCM109-2500Z03R-R0300HA-HU318	31430833
25,00	25	23,5	114	40	58	4,00	3	SCM109-2500Z03R-R0400HA-HU318	31430834

**Configurable features**

**Shank form:**  
Shank form: HB | SL (Safe-lock®) | MQ (HA shank with minimum quantity lubrication\*)

**Cutting edge design:**  
Radius R: 0.40 - 6.50 mm  
Chamfer Cx45°: 0.40 - 1.00 mm

**Coating:**  
Available as DLC coating with cutting material HP910

**Specification:**  
SCM109-2500Z03R-[cutting edge design][shank form]-[coating]

**Dimensions of configurable radii and corner chamfers**

d1	Radius R		Chamfer Cx45°	
	R min.	R max.	Cx45° min.	Cx45° max.
12,00	0,40	3,00	0,40	1,00
16,00	0,50	4,00	0,40	1,00
20,00	0,60	5,20	0,40	1,00
25,00	0,75	6,50	0,40	1,00

**Example:**  
SCM109-2500Z03R-R0150 SL-HP910

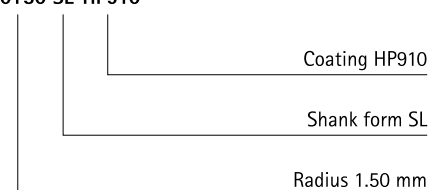

**Safe-lock® by HAIMER**

Manufacturer's ID number: 6272

**Example:** Shank form MQ (MQL shank)

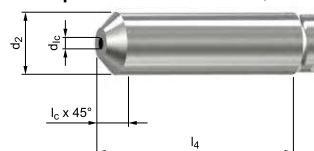

Dimensions in mm.

\* MQL shank design, in accordance with DIN 69090-3.

**MQL shank design in accordance with DIN69090-3**

d2 (h6)	12	16	20	25
l4 (0 / +2)	45	48	50	56
lc (0 / +0.1)	1.7	2.4	3.2	3.7
d1c	2.0	3.0	3.0	4.0

For cutting data recommendations, see chapter "Technical Appendix".  
Special designs and other coatings available upon request.

# OptiMill®-Alu-Wave

Shoulder milling cutter, over-long projection length with neck, with internal coolant supply  
SCM109

**Design:**

Diameter of milling cutter: 12.00 - 25.00 mm  
Cutting material: HU318  
Number of cutting edges: 3  
Helix angle: 36°

**Application:**

Before using in the machine, check the cutting data according to machine performance (see cutting data).

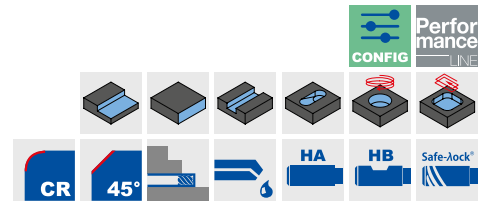
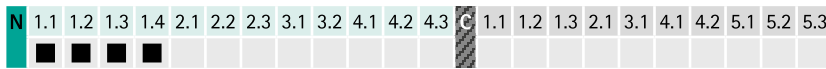
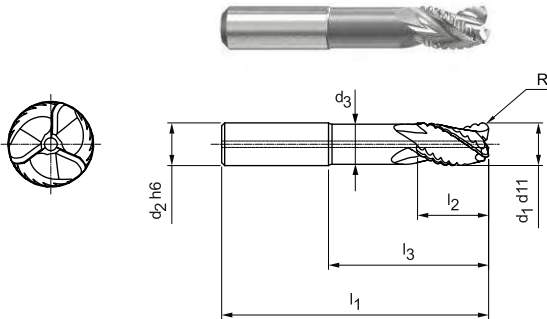

**Preferred series available from stock | Over-long projection length**

Dimensions							z	Specification	Order no.
d1 d11	d2 h6	d3	l1	l2	l3	R			
12,00	12	11,2	95	26	50	2,00	3	SCM109-1200Z03R-R0200HA-HU318	31430822
16,00	16	15,1	115	32	65	3,00	3	SCM109-1600Z03R-R0300HA-HU318	31430825
20,00	20	18,8	125	32	75	3,00	3	SCM109-2000Z03R-R0300HA-HU318	31430829
20,00	20	18,8	125	32	75	4,00	3	SCM109-2000Z03R-R0400HA-HU318	31430830
25,00	25	23,5	136	50	80	3,00	3	SCM109-2500Z03R-R0300HA-HU318	31430835
25,00	25	23,5	136	50	80	4,00	3	SCM109-2500Z03R-R0400HA-HU318	31430836

**Configurable features**

**Shank form:**  
Shank form: HB | SL (Safe-lock®) | MQ (HA shank with MQL\*)

**Cutting edge design:**  
Radius R: 0.40 - 6.50 mm  
Chamfer Cx45°: 0.40 - 1.00 mm

**Coating:**  
Available as DLC coating with cutting material HP910

**Specification:**  
SCM109-2500Z03R-[cutting edge design][shank form]-[coating]

**Dimensions of configurable radii and corner chamfers**

d1	Radius R		Chamfer Cx45°	
	R min.	R max.	Cx45° min.	Cx45° max.
12,00	0,40	3,00	0,40	1,00
16,00	0,50	4,00	0,40	1,00
20,00	0,60	5,20	0,40	1,00
25,00	0,75	6,50	0,40	1,00

**Example:**

SCM109-2500Z03R-R0150 SL-HP910

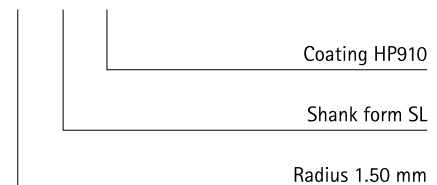

**Safe-lock® by HAIMER**

Manufacturer's ID number: 6272

**Example: Shank form MQ (MQL shank)**

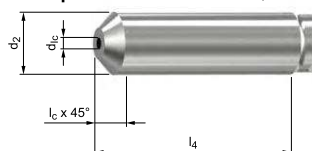

Dimensions in mm.

\* MQL shank design, in accordance with DIN 69090-3.

**MQL shank design in accordance with DIN69090-3**

d2 (h6)	12	16	20	25
l4 (0 / +2)	45	48	50	56
lc (0 / +0.1)	1.7	2.4	3.2	3.7
d1c	2.0	3.0	3.0	4.0

For cutting data recommendations, see chapter "Technical Appendix".  
Special designs and other coatings available upon request.

# OptiMill®-Alu-Wave

Shoulder milling cutter, extra-long projection length with neck, with internal coolant supply  
SCM109

**Design:**

Diameter of milling cutter: 12.00 - 25.00 mm  
Cutting material: HU318  
Number of cutting edges: 3  
Helix angle: 36°

**Application:**

Before using in the machine, check the cutting data according to machine performance (see cutting data).

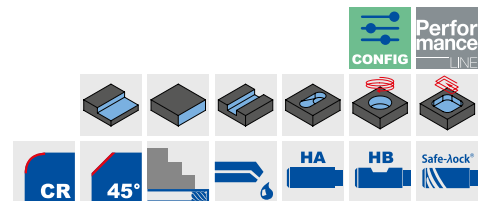
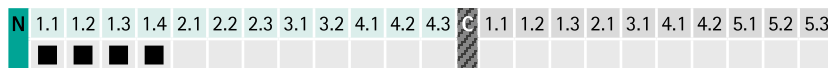
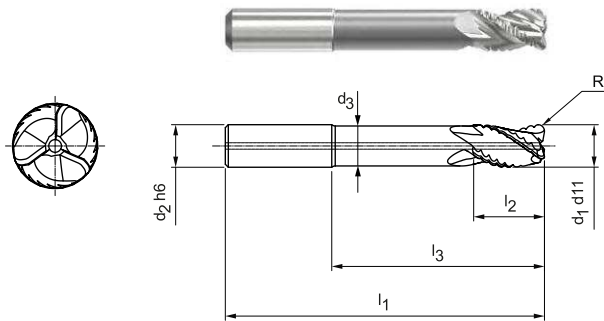

Preferred series available from stock | Extra-long projection length

Dimensions							z	Specification	Order no.
d1 d11	d2 h6	d3	l1	l2	l3	R			
12,00	12	11,2	106	16	60	2,00	3	SCM109-1200Z03R-R0200HA-HU318	31430823
16,00	16	15,1	129	24	80	3,00	3	SCM109-1600Z03R-R0300HA-HU318	31430826
20,00	20	18,8	150	32	100	3,00	3	SCM109-2000Z03R-R0300HA-HU318	31430831
20,00	20	18,8	150	32	100	4,00	3	SCM109-2000Z03R-R0400HA-HU318	31430832
25,00	25	23,5	163	42	107	3,00	3	SCM109-2500Z03R-R0300HA-HU318	31430837
25,00	25	23,5	163	42	107	4,00	3	SCM109-2500Z03R-R0400HA-HU318	31430838

Configurable features

**Shank form:**  
Shank form: HB | SL (Safe-lock®) | MQ (HA shank with minimum quantity lubrication\*)

**Cutting edge design:**  
Radius R: 0.40 - 6.50 mm  
Chamfer Cx45°: 0.40 - 1.00 mm

**Coating:**  
Available as DLC coating with cutting material HP910

**Specification:**  
SCM109-2500Z03R-[cutting edge design][shank form]-[coating]

Dimensions of configurable radii and corner chamfers

d1	Radius R		Chamfer Cx45°	
	R min.	R max.	Cx45° min.	Cx45° max.
12,00	0,40	3,00	0,40	1,00
16,00	0,50	4,00	0,40	1,00
20,00	0,60	5,20	0,40	1,00
25,00	0,75	6,50	0,40	1,00

Example:

SCM109-2500Z03R-R0150 SL-HP910

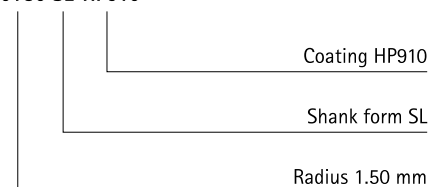

Safe-lock® by HAIMER

Manufacturer's ID number: 6272

Example: Shank form MQ (MQL shank)

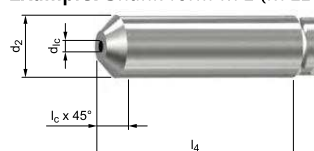

Dimensions in mm.

\* MQL shank design, in accordance with DIN 69090-3.

MQL shank design in accordance with DIN69090-3

d2 (h6)	12	16	20	25
l4 (0 / +2)	45	48	50	56
lc (0 / +0.1)	1.7	2.4	3.2	3.7
d1c	2.0	3.0	3.0	4.0

For cutting data recommendations, see chapter "Technical Appendix".  
Special designs and other coatings available upon request.

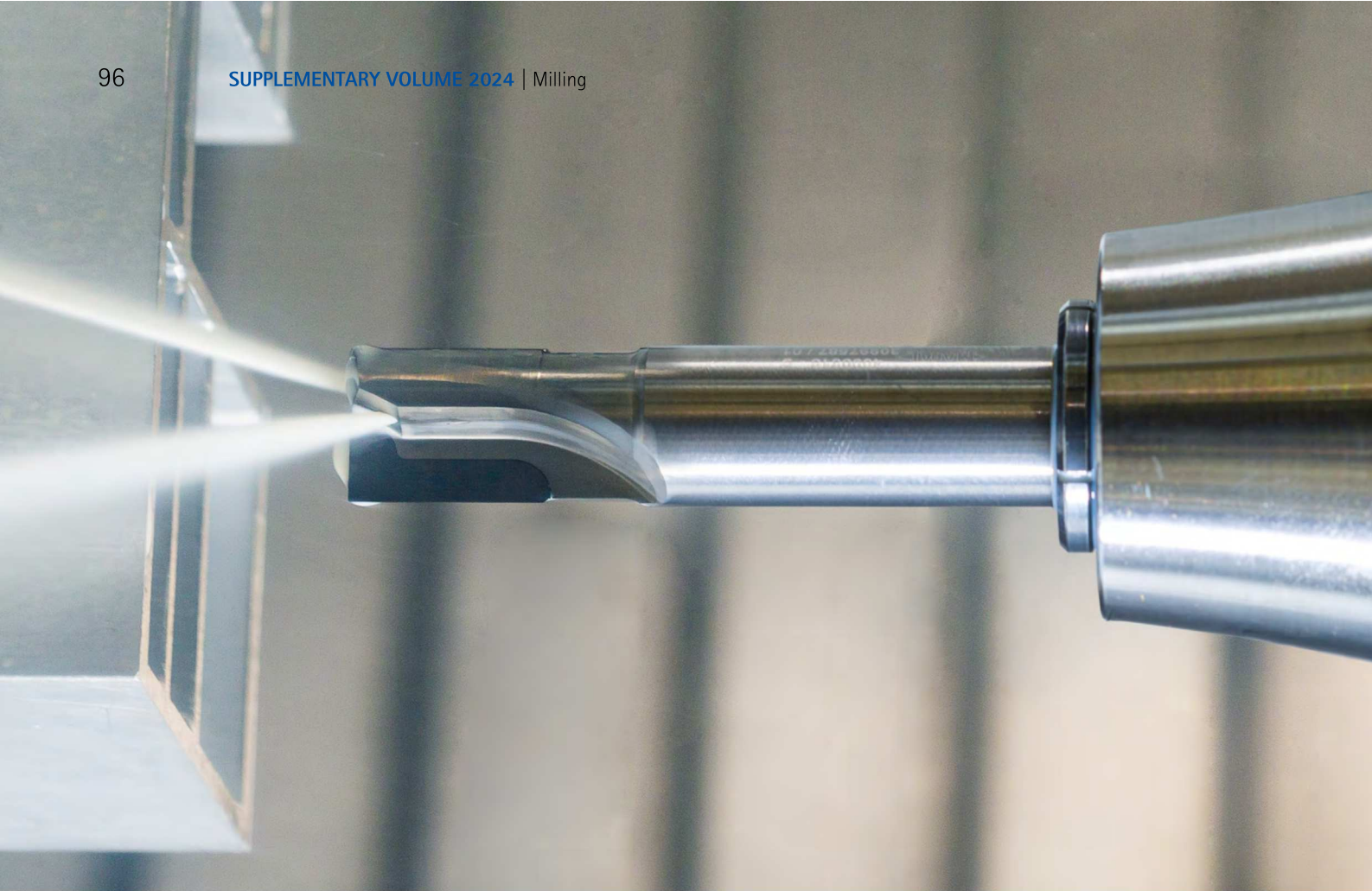

# OptiMill®-Diamond

## New tool design for more productivity

The proven PCD end milling cutters OptiMill-Diamond have undergone a technology update. Many optimisations ensure that users can use the tool to mill non-ferrous metals even more economically and reliably.

Thanks to the revised geometry, the new tools are more rigid and stable than the predeces-

sor models. They thus achieve a longer tool life and more precise results. The new blade design provides more power and material is carried off more efficiently. Optimised chip spaces improve chip removal. This means that surfaces are not damaged by chips, especially for long-chipping aluminium alloys.

The coolant outlet of the redesigned milling cutter OptiMill-Diamond is located on the cutting edge. This extends tool life and improves machining results. The dimensions of the new OptiMill-Diamond series are identical with those of previous models.

### Features

- Can be reground 1 to 3 times
- Can be repeatedly refitted more than twice
- Revised cutting edge design
- New tool design
- Optimised chip spaces
- Direct coolant supply
- Same dimensions

### Tool life comparison [%]

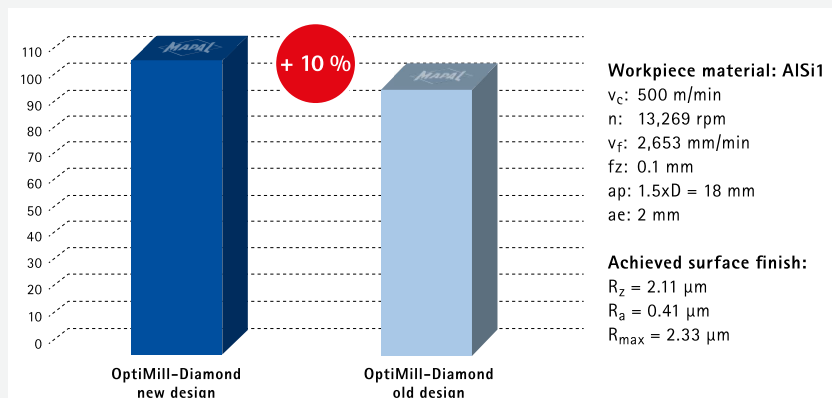



# OptiMill®-Diamond

## Performance optimisation for precise and efficient milling

The revised OptiMill-Diamond PCD end milling cutters provide optimised geometry for stable tools and improved cooling directly on the blade. This results in longer tool life and more precise machining results.

- 1 Revised cutting edge design**
  - More power and precision
- 2 New tool design**
  - Higher rigidity and stability
  - Longer tool life and more precise results
- 3 Optimised chip spaces**
  - Improved chip removal and better surfaces
- 4 Direct coolant supply**
  - Optimal cooling and thermal management on the cutting edge
- 5 Same dimensions**
  - No need to switch to new product range

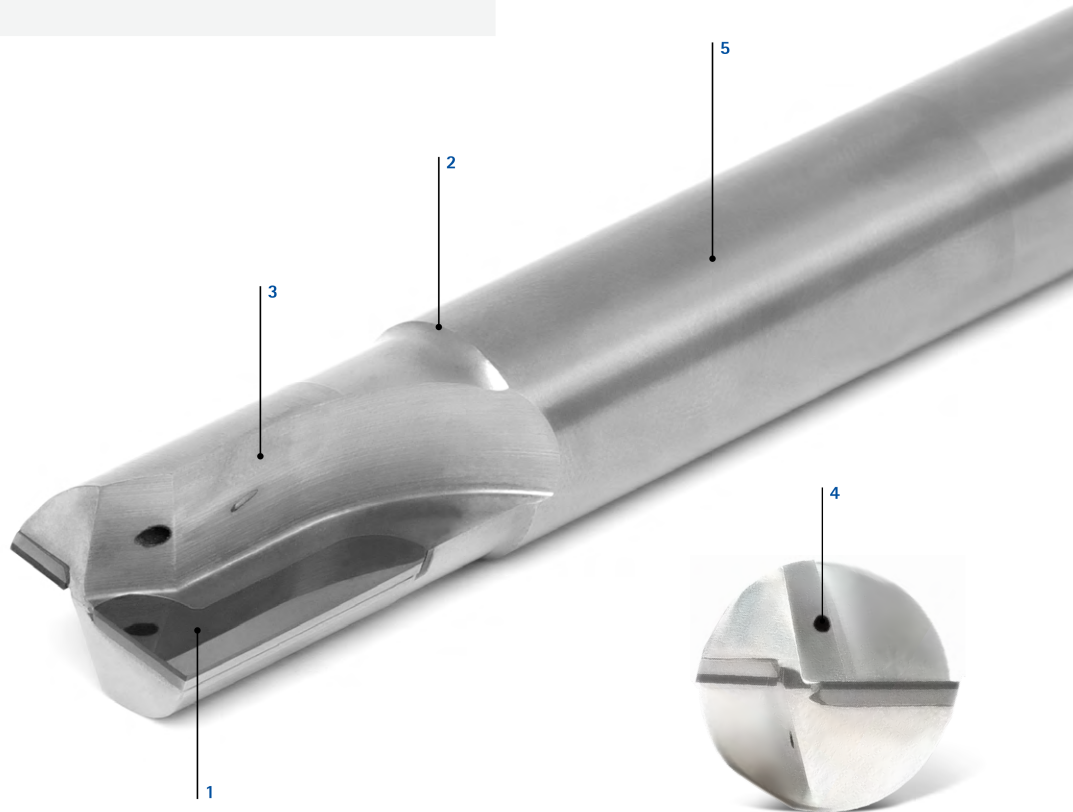

**Basic Line:**  
 Universal tools, broad field of application,  
 low procurement costs



OptiMill-Diamond old design



**Increased productivity**



**NEW**



OptiMill-Diamond new design

● ● ● ● ●

● ● ● ● ●

 Tool life  
 Accuracy

● ● ● ● ●

● ● ● ● ●

# OptiMill®-Diamond type 50

Shoulder milling cutter, overlong design with neck  
SHM500

**Design:**

Diameter of milling cutter: 4.00 - 5.00 mm  
Cutting material: PU611  
Number of cutting edges: 1  
Axis angle: 0°  
Special feature: PCD cutting edge

**Application:**

Designed for delicate milling tasks, e.g. in precision mechanics or for the production of printed circuit boards.

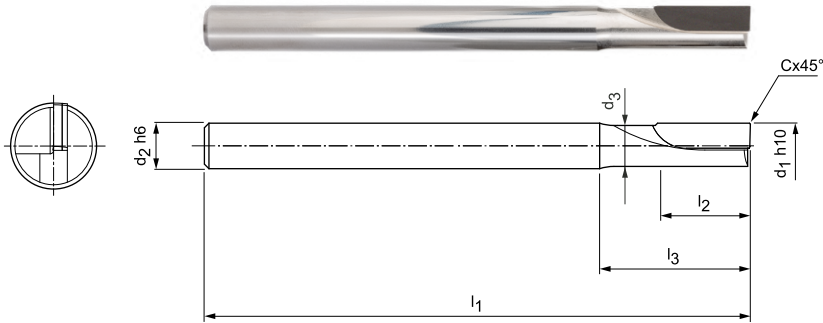

N	1.1	1.2	1.3	1.4	2.1	2.2	2.3	3.1	3.2	4.1	4.2	4.3	C	1.1	1.2	1.3	2.1	3.1	4.1	4.2	5.1	5.2	5.3	
	■	■	■	■	■	■	■	■	■	■	■	■	■	■	■	■	■	■	■	■	■	■	■	■

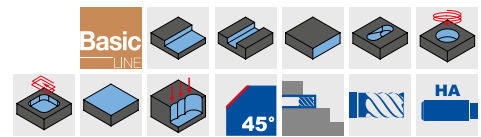

**Preferred series available from stock**

Dimensions							z	Specification	Order no.
d1 h10	d2 h6	d3	l1	l2	l3	Cx45°			
4,00	4	3,6	60	10	15	0,10	1	SHM500-0400BZ01R-F0010HA-PU611	31348186
5,00	5	4,4	60	10	15	0,10	1	SHM500-0500BZ01R-F0010HA-PU611	31348187

Dimensions in mm.  
For cutting data recommendations, see chapter "Technical Appendix".  
Special designs and other coatings available upon request.

# OptiMill®-Diamond type 51

Shoulder milling cutter, overlong design with neck, includes internal cooling  
SHM511 | SHM611 | SHM711

**Design:**

Diameter of milling cutter: 3.00 - 12.00 mm  
Cutting material: PU611  
Number of cutting edges: 2  
Axis angle: neutral/positive/negative  
Special feature: PCD cutting edge

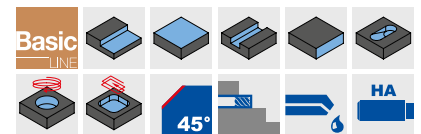
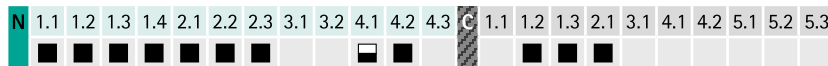
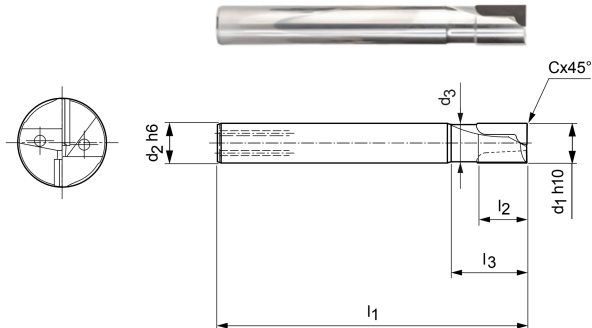

**Preferred series available from stock**

Dimensions							Axis angle depending on type [°]	z	Specification	Order no.		
d <sub>1</sub> h10	d <sub>2</sub> h6	d <sub>3</sub>	l <sub>1</sub>	l <sub>2</sub>	l <sub>3</sub>	Cx45°				SHM511	SHM611	SHM711
3,00	6	2,8	60	2,5	15	0,10	0   -2   2	2	SHM_*1-0300AZ02R-F0010HA-PU611	31348188	31348210	31348222
4,00	6	3,8	60	2,5	15	0,10	0   -2   2	2	SHM_*1-0400AZ02R-F0010HA-PU611	31348189	31348211	31348223
5,00	6	4,6	60	3	15	0,10	0   -2   2	2	SHM_*1-0500AZ02R-F0010HA-PU611	31348200	31348212	31348224
6,00	6	5,4	60	10	15	0,10	0   -2   2	2	SHM_*1-0600BZ02R-F0010HA-PU611	31348201	31348213	31348225
6,00	6	5,4	60	15	20	0,10	0   -2   2	2	SHM_*1-0600CZ02R-F0010HA-PU611	31348202	31348214	31348226
8,00	8	7,4	80	10	20	0,10	0   -4   4	2	SHM_*1-0800BZ02R-F0010HA-PU611	31348203	31348215	31348227
8,00	8	7,4	80	20	30	0,10	0   -2   2	2	SHM_*1-0800DZ02R-F0010HA-PU611	31348204	31348216	31348228
10,00	10	9,4	80	10	30	0,10	0   -4   4	2	SHM_*1-1000BZ02R-F0010HA-PU611	31348205	31348217	31348229
10,00	10	9,4	90	20	30	0,10	0   -4   4	2	SHM_*1-1000DZ02R-F0010HA-PU611	31348206	31348218	31348230
12,00	12	11	100	10	30	0,10	0   -4   4	2	SHM_*1-1200BZ02R-F0010HA-PU611	31348207	31348219	31348231
12,00	12	11	100	20	30	0,10	0   -4   4	2	SHM_*1-1200DZ02R-F0010HA-PU611	31348208	31348220	31348232

**Axis angle**

SHM511	SHM611	SHM711
Neutral cutting-edge position	Negative cutting-edge position	Positive cutting-edge position

**Application**

<ul style="list-style-type: none"> <li>- For universal applications</li> <li>- Ideal for changing applications (roughing/finishing/ramps/trimming/...)</li> </ul>	<ul style="list-style-type: none"> <li>- For unstable clamping setups to a fixed stop</li> <li>- Good for trimming (without face cut)</li> <li>- Very limited for high stock removal and plunging / ramping in</li> </ul>	<ul style="list-style-type: none"> <li>- Soft cutting and good chip removal</li> <li>- Low cutting forces (machine capacity)</li> </ul>
---	---	---

Dimensions in mm.

For cutting data recommendations, see chapter "Technical Appendix".

\* Specification as well as desired cutting edge form (see "Axis angle" table).

Special designs and CVD-tipped tools available upon request.

# OptiMill®-Diamond type 53

Shoulder milling cutter, long design with neck, includes internal cooling  
SHM531

## Design:

Diameter of milling cutter: 6.00 – 20.00 mm  
Cutting material: PU611  
Number of cutting edges: 2 to  $\varnothing$  12 mm  
3 from  $\varnothing$  14 mm  
Axis angle:  $2^\circ/4^\circ/6^\circ$   
Special features: No centre blade  
PCD cutting edge

## Application:

Specially designed for high material removal rates and feeds per tooth. Closed pockets are machined by plunging into the workpiece.

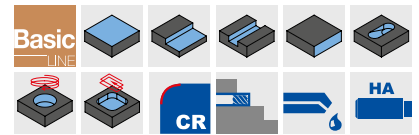
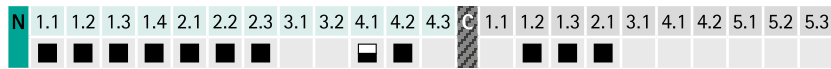
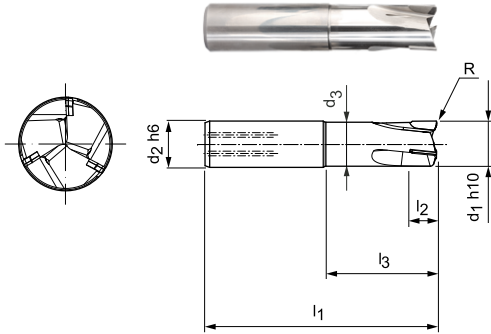

## Preferred series available from stock

Dimensions								Ramp angle	z	Specification	Order no.
d <sub>1</sub> h10	d <sub>2</sub> h6	d <sub>3</sub>	l <sub>1</sub>	l <sub>2</sub>	l <sub>3</sub>	R	Axis angle				
6,00	8	5	55	6	15	0,2	2	3	2	SHM531-0600AZ02R-R0020HA-PU611	31348242
10,00	10	9	75	6	20	0,2	4	3	2	SHM531-1000AZ02R-R0020HA-PU611	31348243
12,00	12	11	85	10	25	0,2	6	2	2	SHM531-1200BZ02R-R0020HA-PU611	31348244
14,00	16	13	85	10	25	0,2	6	5	3	SHM531-1400BZ03R-R0020HA-PU611	31348245
16,00	16	15	85	10	25	0,2	6	4	3	SHM531-1600BZ03R-R0020HA-PU611	31348246
20,00	20	19	100	10	50	0,2	6	3	3	SHM531-2000BZ03R-R0020HA-PU611	31348247

## Available on request

8,00	8	7,2	60	6	20	0,2	2	3	2	SHM531-0800AZ02R-R0020HA-PU611	31476912
------	---	-----	----	---	----	-----	---	---	---	--------------------------------	----------

Dimensions in mm.

For cutting data recommendations, see chapter "Technical Appendix".

Special designs and other coatings available upon request.

# OptiMill®-Diamond radius

Ball cutter, overlong design with neck, includes internal cooling  
SHM521

**Design:**

Diameter of milling cutter: 3.00 - 16.00 mm  
Cutting material: PU611  
Number of cutting edges: 2  
Axis angle: 0°  
Special features: PCD cutting edges for a long tool life

**Application:**

Ideal for contour and form milling aluminium parts.

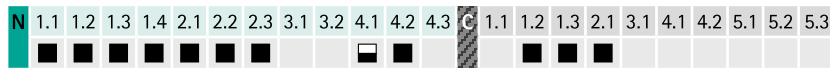
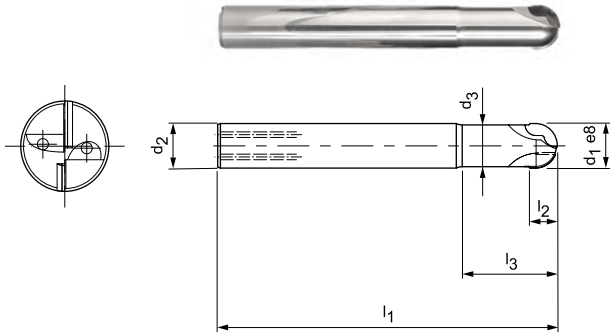

**Preferred series available from stock**

Dimensions							z	Specification	Order no.
d <sub>1</sub> h10	d <sub>2</sub> h6	d <sub>3</sub>	l <sub>1</sub>	l <sub>2</sub>	l <sub>3</sub>	R			
3,00	6	2,8	60	2,5	9	1,5	2	SHM521-0300AZ02R-R0150HA-PU611	31348234
4,00	6	3,8	60	2,5	15	2	2	SHM521-0400AZ02R-R0200HA-PU611	31348235
5,00	6	4,6	60	3	15	2,5	2	SHM521-0500AZ02R-R0250HA-PU611	31348236
6,00	6	5,5	80	6	15	3	2	SHM521-0600BZ02R-R0300HA-PU611	31348237
8,00	8	6,9	80	10	20	4	2	SHM521-0800BZ02R-R0400HA-PU611	31348238
10,00	10	8,9	80	10	26	5	2	SHM521-1000BZ02R-R0500HA-PU611	31348239
12,00	12	11,2	100	10	35	6	2	SHM521-1200BZ02R-R0600HA-PU611	31348240
16,00	16	15	125	10	35	8	2	SHM521-1600BZ02R-R0800HA-PU611	31348241

Dimensions in mm.

For cutting data recommendations, see chapter "Technical Appendix".

Special designs and CVD-tipped tools available upon request.

# OptiMill®-Diamond-Torus

Corner radius milling cutter, long design with neck, includes internal cooling  
SHM551

**Design:**

Diameter of milling cutter: 3.00 - 12.00 mm  
Cutting material: PU611  
Number of cutting edges: 2  
Axis angle: 0°  
Special features: PCD cutting edges for a long tool life

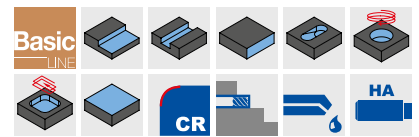
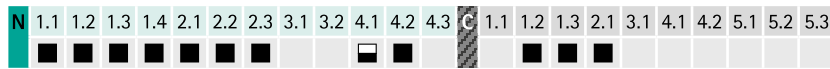
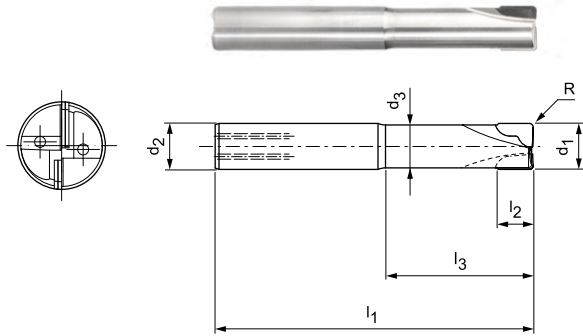

**Preferred series available from stock**

Dimensions							z	Specification	Order no.
d <sub>1</sub> e8	d <sub>2</sub> h6	d <sub>3</sub>	l <sub>1</sub>	l <sub>2</sub>	l <sub>3</sub>	R			
3,00	6	2,8	50	2,5	14	0,3	2	SHM551-0300AZ02R-R0030HA-PU611	31348248
4,00	6	3,8	50	2,5	14	0,5	2	SHM551-0400AZ02R-R0050HA-PU611	31348249
5,00	6	4,6	54	3	18	0,5	2	SHM551-0500AZ02R-R0050HA-PU611	31348250
6,00	6	5,5	57	6	21	0,5	2	SHM551-0600BZ02R-R0050HA-PU611	31348251
6,00	6	5,5	57	6	21	1	2	SHM551-0600BZ02R-R0100HA-PU611	31348252
8,00	8	7,4	63	7	27	0,5	2	SHM551-0800BZ02R-R0050HA-PU611	31348253
10,00	10	9,2	72	8	32	0,5	2	SHM551-1000BZ02R-R0050HA-PU611	31348254
10,00	10	9,2	72	8	32	1	2	SHM551-1000BZ02R-R0100HA-PU611	31348255

**Available on request**

Dimensions							z	Specification	Order no.
d <sub>1</sub> e8	d <sub>2</sub> h6	d <sub>3</sub>	l <sub>1</sub>	l <sub>2</sub>	l <sub>3</sub>	R			
3,00	6	2,8	50	2,5	14	0,5	2	SHM551-0300AZ02R-R0050HA-PU611	31476913
3,00	6	2,8	50	2,5	14	1	2	SHM551-0300AZ02R-R0100HA-PU611	31476914
4,00	6	3,8	50	2,5	14	0,3	2	SHM551-0400AZ02R-R0030HA-PU611	31476915
4,00	6	3,8	50	2,5	14	1	2	SHM551-0400AZ02R-R0100HA-PU611	31476916
5,00	6	4,6	54	3	18	1	2	SHM551-0500AZ02R-R0100HA-PU611	31476917
6,00	6	5,5	57	6	21	1,5	2	SHM551-0600BZ02R-R0150HA-PU611	31476918
8,00	8	7,4	63	7	27	1	2	SHM551-0800BZ02R-R0100HA-PU611	31476919
8,00	8	7,4	63	7	27	1,5	2	SHM551-0800BZ02R-R0150HA-PU611	31476940
8,00	8	7,4	63	7	27	2	2	SHM551-0800BZ02R-R0200HA-PU611	31476941
10,00	10	9,2	72	8	32	1,5	2	SHM551-1000BZ02R-R0150HA-PU611	31476942
10,00	10	9,2	72	8	32	2	2	SHM551-1000BZ02R-R0200HA-PU611	31476943
12,00	12	11,2	83	9	38	0,5	2	SHM551-1200BZ02R-R0050HA-PU611	31476944
12,00	12	11,2	83	9	38	1	2	SHM551-1200BZ02R-R0100HA-PU611	31476945
12,00	12	11,2	83	9	38	1,5	2	SHM551-1200BZ02R-R0150HA-PU611	31476946
12,00	12	11,2	83	9	38	2	2	SHM551-1200BZ02R-R0200HA-PU611	31476947

Dimensions in mm.  
For cutting data recommendations, see chapter "Technical Appendix".  
Special designs and other coatings available upon request.

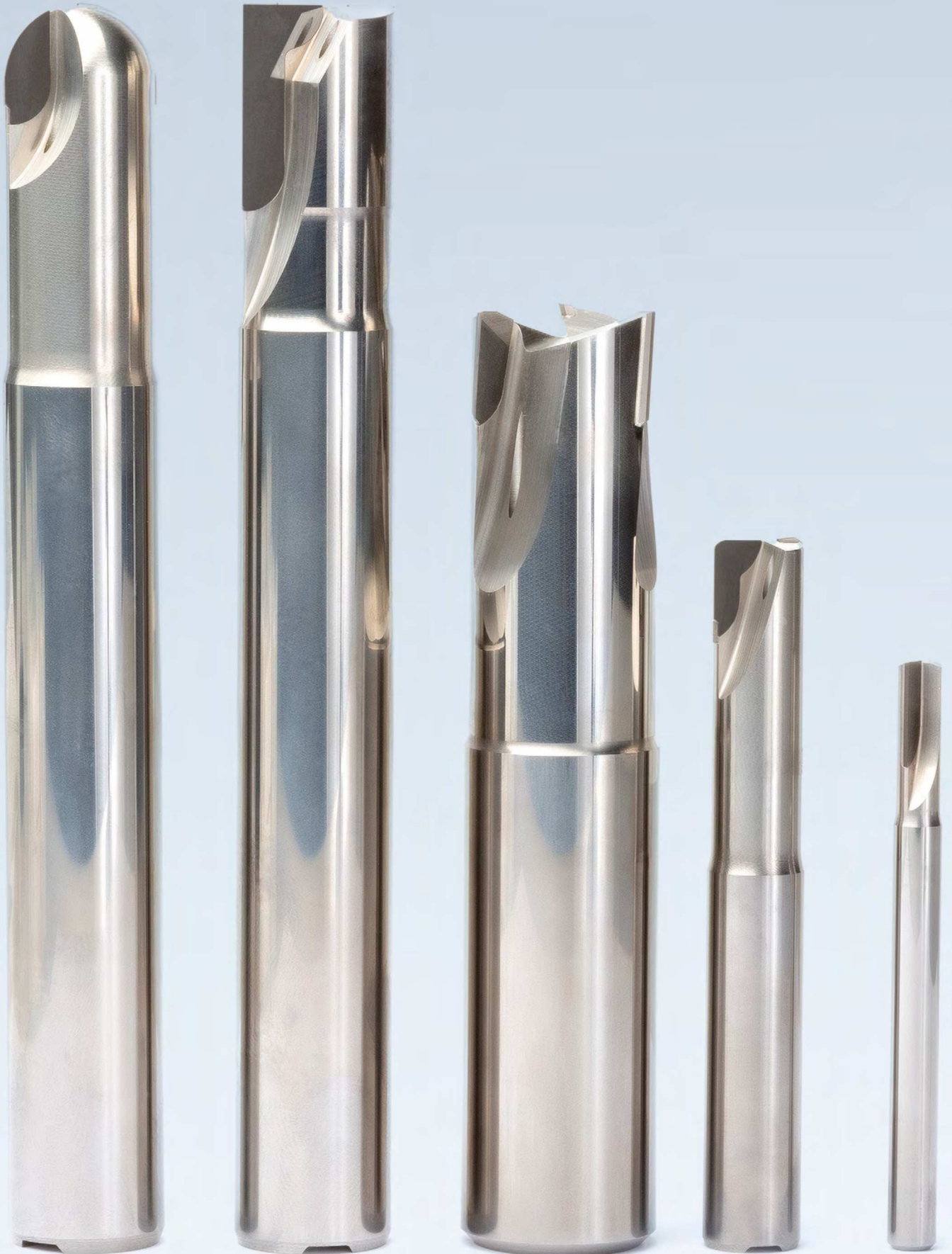

# OptiMill®-Tro-Inox

## Six-edge trochoidal milling cutter for milling in stainless steel

The specific kinematics of trochoidal milling makes it possible to positively influence the contact conditions as a circular movement of the tool is superimposed on the feed movement. The contact angle is correspondingly low. The result of this technological approach is that a reduced cutting width and cutting length lead to significantly reduced process forces.

### 1 Face geometry

- 6 blades
- Diameter: 6.00 mm to 25.00 mm
- Cutting material HP826

### 2 Helix angle

- Helix angle 41°–42°
- Unequal spacing
- Helix angles specially adapted to the length ratio of 3xD to reduce pull-out forces

### 3 Carbide & coating

- Tough carbide for highly dynamic loads
- AlTiN-based multi-layer coating for ideal thermal stability

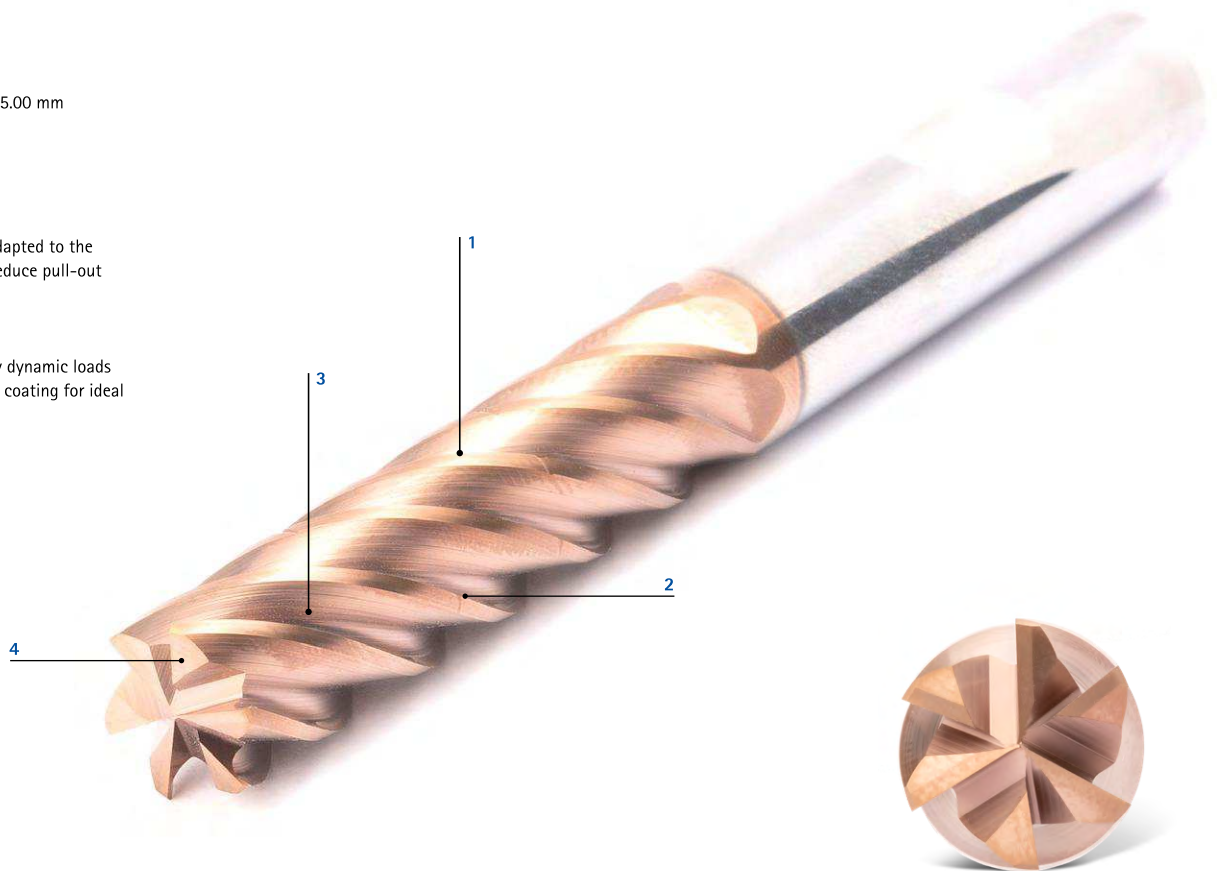

## Features

- Preferred series available from stock:
  - Ø area: 4 mm up to 20 mm
- Available upon request
  - Ø area: 14, 18, and 25 mm
- Number of cutting edges 6
- Unequal spacing
- Especially for trochoidal milling
- For cutting depths up to 5xD

## Comparison of the maximum machining volume up to the end of tool life [l]

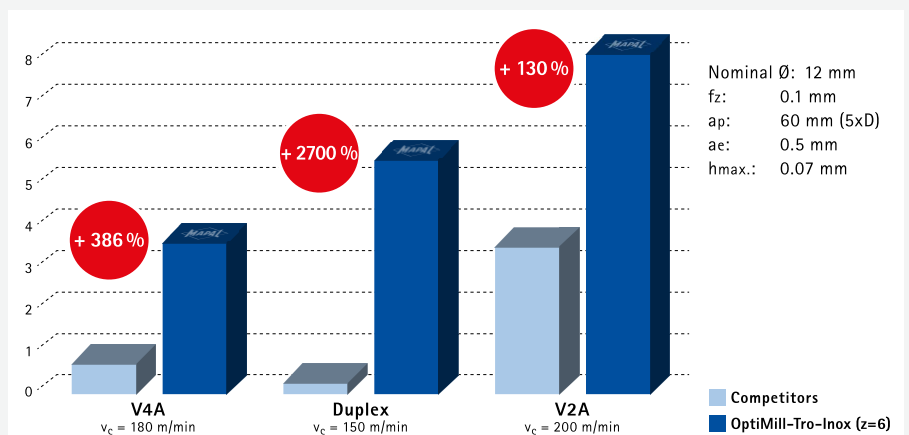



# OptiMill®-Tro-Inox

Shoulder milling cutter, 2xD design with neck, with chip breaker  
SCM292

**Design:**

Diameter of milling cutter: 4.00 - 25.00 mm  
Cutting material: HP826  
Number of cutting edges: 6  
Helix angle: 36°  
Special feature: Cutting edge portion balanced on G2.5 according to DIN ISO1940-G2.5

**Application:**

Design with chip breaker for optimum chip control. Ensures chips are shortened.

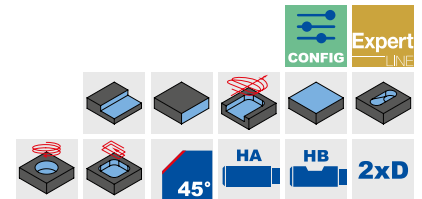
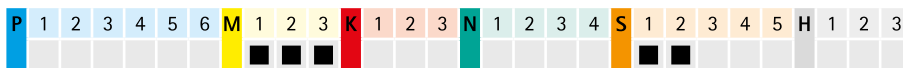
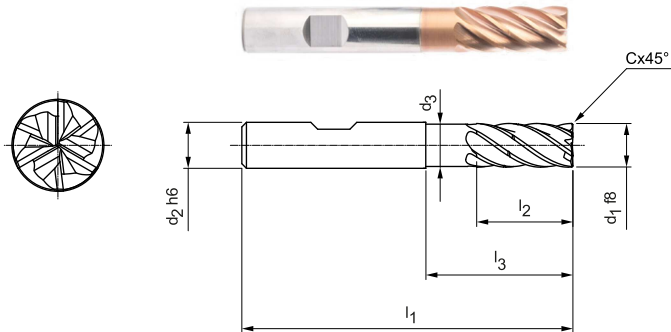

**Preferred series available from stock**

Dimensions							z	Chip breaker	Shank form HB	
d1 f8	d2 h6	d3	l1	l2	l3	Cx45°			Specification	Order no.
4,00	6	3,9	57	11	13	0,08	6	-	SCM292-0400Z06R-F0008HB2-HP826	31348624
5,00	6	4,8	57	13	15,5	0,1	6	-	SCM292-0500Z06R-F0010HB2-HP826	31348625
6,00	6	5,8	57	13	19	0,12	6	-	SCM292-0600Z06R-F0012HB2-HP826	31348626
8,00	8	7,8	63	19	25	0,16	6	-	SCM292-0800Z06R-F0016HB2-HP826	31348627
10,00	10	9,8	72	22	30	0,2	6	-	SCM292-1000Z06R-F0020HB2-HP826	31348628
12,00	12	11,8	83	26	36	0,24	6	1	SCM292-1200Z06R-F0024HB2-HP826	31348629
16,00	16	15,8	92	32	42	0,32	6	1	SCM292-1600Z06R-F0032HB2-HP826	31348631
20,00	20	19,8	104	41	52	0,4	6	1	SCM292-2000Z06R-F0040HB2-HP826	31348633

**Available on request**

14,00	14	13,8	83	26	36	0,28	6	1	SCM292-1400Z06R-F0028HB2-HP826	31348630
18,00	18	17,8	92	32	42	0,36	6	1	SCM292-1800Z06R-F0036HB2-HP826	31348632
25,00	25	24,5	125	50	65	0,5	6	1	SCM292-2500Z06R-F0050HB2-HP826	31348634

**Configurable features**

**Shank form:**  
Shank form: HA

**Specification:**  
SCM292-0400Z06R-F0008[shank form]2-HP826

**Example:**

SCM292-0400Z06R-F0008HA2-HP826



Dimensions in mm.

For cutting data recommendations, see chapter "Technical Appendix".  
Special designs and other coatings available upon request.

# OptiMill®-Tro-Inox

Shoulder milling cutter, 3xD design with neck, includes chip breaker  
SCM292

**Design:**

Diameter of milling cutter: 4.00 - 25.00 mm  
Cutting material: HP826  
Number of cutting edges: 6  
Helix angle: 36°  
Special feature: Cutting edge portion balanced on G2.5 according to DIN ISO1940-G2.5

**Application:**

Design with chip breaker for optimum chip control. Ensures chips are shortened.

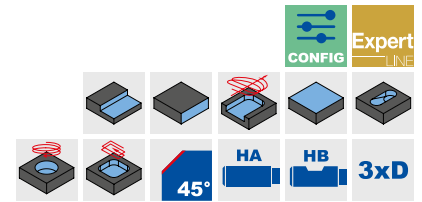
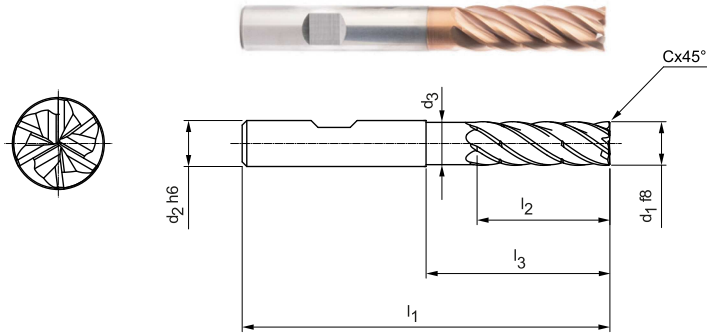

**Preferred series available from stock**

Dimensions							z	Chip breaker	Shank form HB	
d1 f8	d2 h6	d3	l1	l2	l3	Cx45°			Specification	Order no.
4,00	6	3,9	62	16	23	0,08	6	1	SCM292-0400Z06R-F0008HB3-HP826	31348635
5,00	6	4,8	62	17	24	0,1	6	1	SCM292-0500Z06R-F0010HB3-HP826	31348636
6,00	6	5,8	62	18	25	0,12	6	1	SCM292-0600Z06R-F0012HB3-HP826	31348637
8,00	8	7,8	68	24	30	0,16	6	1	SCM292-0800Z06R-F0016HB3-HP826	31348638
10,00	10	9,8	80	30	35	0,2	6	1	SCM292-1000Z06R-F0020HB3-HP826	31348639
12,00	12	11,8	93	36	45	0,24	6	2	SCM292-1200Z06R-F0024HB3-HP826	31348640
14,00	14	13,8	99	42	50	0,28	6	2	SCM292-1400Z06R-F0028HB3-HP826	31348641
16,00	16	15,8	108	48	55	0,32	6	2	SCM292-1600Z06R-F0032HB3-HP826	31348642
20,00	20	19,8	126	60	70	0,4	6	2	SCM292-2000Z06R-F0040HB3-HP826	31348644

**Available on request**

18,00	18	17,8	117	54	67	0,36	6	2	SCM292-1800Z06R-F0036HB3-HP826	31348643
25,00	25	24,5	150	75	92	0,5	6	2	SCM292-2500Z06R-F0050HB3-HP826	31348645

**Configurable features**



**Shank form:**  
Shank form: HA



**Specification:**  
SCM292-0400Z06R-F0008[shank form]3-HP826

**Example:**

SCM292-0400Z06R-F0008HA3-HP826



Dimensions in mm.

For cutting data recommendations, see chapter "Technical Appendix".

Special designs and other coatings available upon request.

# OptiMill®-Tro-Inox

Shoulder milling cutter, 4xD design, with chip breaker  
SCM292

**Design:**

Diameter of milling cutter: 5.00 - 25.00 mm  
Cutting material: HP826  
Number of cutting edges: 6  
Helix angle: 36°  
Special feature: Cutting edge portion balanced on G2.5 according to DIN ISO1940-G2.5

**Application:**

Design with chip breaker for optimum chip control. Ensures chips are shortened.

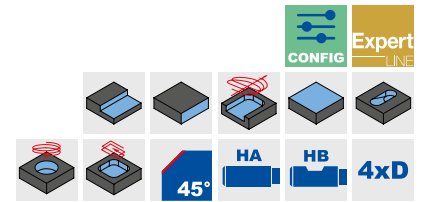
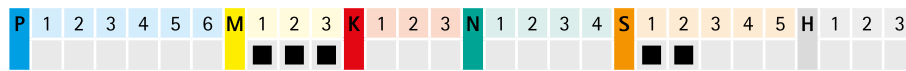
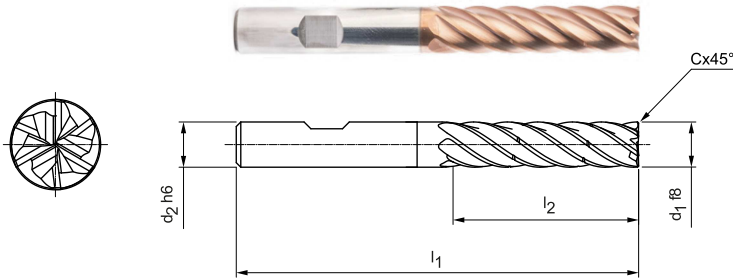

**Preferred series available from stock**

Dimensions					z	Chip breaker	Shank form HB	
d <sub>1</sub> f8	d <sub>2</sub> h6	l <sub>1</sub>	l <sub>2</sub>	Cx45°			Specification	Order no.
5,00	6	66	20	0,10	6	2	SCM292-0500Z06R-F0010HB4-HP826	31348646
6,00	6	66	24	0,12	6	2	SCM292-0600Z06R-F0012HB4-HP826	31348647
8,00	8	74	32	0,16	6	2	SCM292-0800Z06R-F0016HB4-HP826	31348648
10,00	10	89	40	0,20	6	2	SCM292-1000Z06R-F0020HB4-HP826	31348649
12,00	12	100	48	0,24	6	2	SCM292-1200Z06R-F0024HB4-HP826	31348650
16,00	16	123	64	0,32	6	2	SCM292-1600Z06R-F0032HB4-HP826	31348652
20,00	20	140	80	0,40	6	2	SCM292-2000Z06R-F0040HB4-HP826	31348654

**Available on request**

14,00	14	108	56	0,28	6	2	SCM292-1400Z06R-F0028HB4-HP826	31348651
18,00	18	130	72	0,36	6	2	SCM292-1800Z06R-F0036HB4-HP826	31348653
25,00	25	170	100	0,5	6	2	SCM292-2500Z06R-F0050HB4-HP826	31348655

**Configurable features**



**Shank form:**  
Shank form: HA



**Specification:**  
SCM292-0500Z06R-F0008[shank form]4-HP826

**Example:**

SCM292-0500Z06R-F0008HA4-HP826



Dimensions in mm.

For cutting data recommendations, see chapter "Technical Appendix".  
Special designs and other coatings available upon request.

# OptiMill®-Tro-Inox

Shoulder milling cutter, 5xD design, with chip breaker  
SCM292

**Design:**

Diameter of milling cutter: 8.00 - 25.00 mm  
Cutting material: HP826  
Number of cutting edges: 6  
Helix angle: 36°  
Special feature: Cutting edge portion balanced on G2.5 according to DIN ISO1940-G2.5

**Application:**

Design with chip breaker for optimum chip control. Ensures chips are shortened.

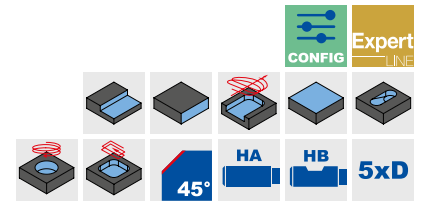
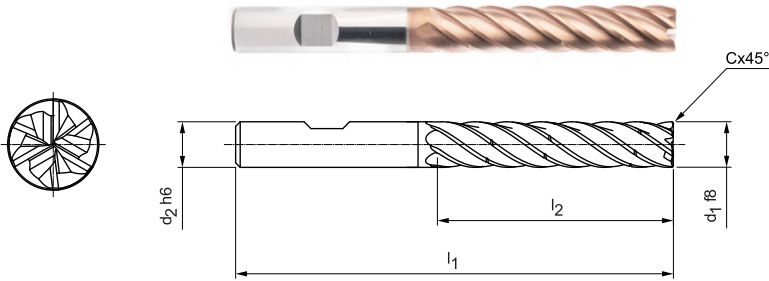

**Preferred series available from stock**

Dimensions					z	Chip breaker	Shank form HB	
d <sub>1</sub> f8	d <sub>2</sub> h6	l <sub>1</sub>	l <sub>2</sub>	Cx45°			Specification	Order no.
8,00	8	81	40	0,16	6	3	SCM292-0800Z06R-F0016HB5-HP826	31348656
10,00	10	96	50	0,20	6	3	SCM292-1000Z06R-F0020HB5-HP826	31348657
12,00	12	112	60	0,24	6	3	SCM292-1200Z06R-F0024HB5-HP826	31348658
16,00	16	136	80	0,32	6	3	SCM292-1600Z06R-F0032HB5-HP826	31348660
20,00	20	160	100	0,40	6	3	SCM292-2000Z06R-F0040HB5-HP826	31348662

**Available on request**

14	14	122	70	0,28	6	3	SCM292-1400Z06R-F0028HB5-HP826	31348659
18	18	147	90	0,36	6	3	SCM292-1800Z06R-F0036HB5-HP826	31348661
25	25	195	125	0,5	6	3	SCM292-2500Z06R-F0050HB5-HP826	31348663

**Configurable features**



**Shank form:**  
Shank form: HA



**Specification:**  
SCM292-0800Z06R-F0008[shank form]5-HP826

**Example:**

SCM292-0800Z06R-F0008HA5-HP826



Dimensions in mm.

For cutting data recommendations, see chapter "Technical Appendix".

Special designs and other coatings available upon request.



# OptiMill®-Titan-HPC

## Versatile roughing and finishing

The OptiMill-Titan-HPC four-edge shoulder milling cutter is a versatile tool. The end milling cutter made of solid carbide can be used for roughing as well as finishing. The special cutting edge finish creates optimal surfaces.

### 1 Novel groove profile

- Very high stability and very good chip removal
- Polished chip spaces for optimal chip transport

### 2 Unequal spacing and gradient

- Runs as quietly as possible due to varying helix angle design and cutting edge spacing
- Full slot milling up to a depth of 1.5xD possible

### 3 New coating technology

- AlTiN-based multi-layer coating for high thermal loads

### 4 Different corner radii variants available

- For machining of part as close to the contour as possible



## Features

### Dimensions:

- Shoulder milling cutter shank form
- $\varnothing$  area: 6 mm up to 25 mm
- Number of cutting edges 4
- Unequal spacing
- Shank connection 6, 8, 10, 12, 16, 20 and 25 mm
- Cutting edge finish creates optimal surfaces

## Tool life [m]

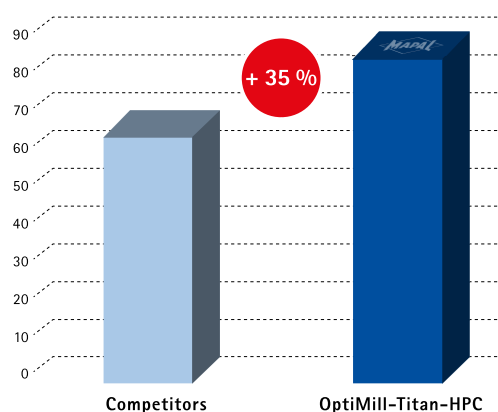

### Ti6Al4V-1.1800

Tool $\varnothing$ :	12 mm
$v_c$ :	80 m/min
$f_z$ :	0.06 mm
$a_p$ :	12 mm
$a_e$ :	4.8 mm

# OptiMill®-Titan-HPC

Shoulder milling cutter, long design with neck  
SCM394

**Design:**

Diameter of milling cutter: 6.00 - 25.00 mm  
Cutting material: HP826  
Number of cutting edges: 4  
Helix angle: 43°  
Special feature: Unequal spacing

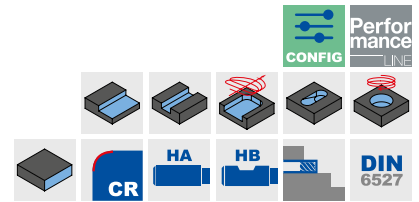
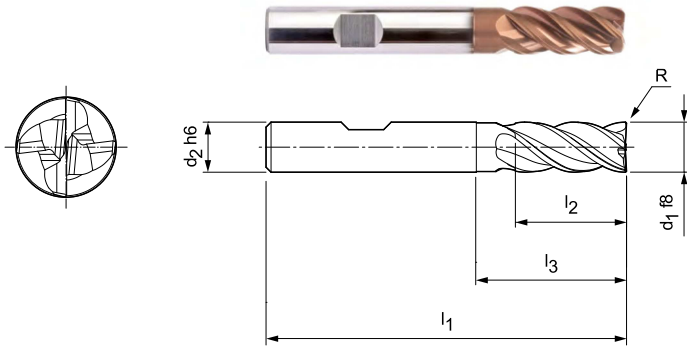

**Preferred series available from stock**

Dimensions							Specification	Order no.
d1 f8	d2 h6	l1	l2	d3	l3	R		
6,00	6	57	13	5,8	20	0,50	SCM394-0600Z04R-R0050HB-HP826	31304509
6,00	6	57	13	5,8	20	1,00	SCM394-0600Z04R-R0100HB-HP826	31304544
8,00	8	63	21	7,8	25	0,50	SCM394-0800Z04R-R0050HB-HP826	31304547
8,00	8	63	21	7,8	25	1,00	SCM394-0800Z04R-R0100HB-HP826	31304549
10,00	10	72	22	9,8	30	0,50	SCM394-1000Z04R-R0050HB-HP826	31304552
10,00	10	72	22	9,8	30	1,00	SCM394-1000Z04R-R0100HB-HP826	31304554
12,00	12	83	26	11,8	36	0,50	SCM394-1200Z04R-R0050HB-HP826	31304557
12,00	12	83	26	11,8	36	1,00	SCM394-1200Z04R-R0100HB-HP826	31304558
16,00	16	92	36	15,8	42	1,00	SCM394-1600Z04R-R0100HB-HP826	31304573
16,00	16	92	36	15,8	42	2,00	SCM394-1600Z04R-R0200HB-HP826	31304575
20,00	20	104	41	19,7	55	1,00	SCM394-2000Z04R-R0100HB-HP826	31304580
20,00	20	104	41	19,7	55	2,00	SCM394-2000Z04R-R0200HB-HP826	31304582
25,00	25	136	50	24,7	65	2,00	SCM394-2500Z04R-R0200HB-HP826	31304586

**Available on request**

8,00	8	63	21	7,8	25	2,00	SCM394-0800Z04R-R0200HB-HP826	31304551
10,00	10	72	22	9,8	30	2,00	SCM394-1000Z04R-R0200HB-HP826	31304555
12,00	12	83	26	11,8	36	2,00	SCM394-1200Z04R-R0200HB-HP826	31304570
12,00	12	83	26	11,8	36	3,00	SCM394-1200Z04R-R0300HB-HP826	31304571
16,00	16	92	36	15,8	42	3,00	SCM394-1600Z04R-R0300HB-HP826	31304576
16,00	16	92	36	15,8	42	4,00	SCM394-1600Z04R-R0400HB-HP826	31304578
20,00	20	104	41	19,7	55	3,00	SCM394-2000Z04R-R0300HB-HP826	31304583
20,00	20	104	41	19,7	55	4,00	SCM394-2000Z04R-R0400HB-HP826	31304585
25,00	25	136	50	24,7	65	3,00	SCM394-2500Z04R-R0300HB-HP826	31304588
25,00	25	136	50	24,7	65	4,00	SCM394-2500Z04R-R0400HB-HP826	31304589

**Configurable features**

**Shank form:**  
Shank form: HA

**Specification:**  
SCM394-1200Z04R-R0300[shank form]-HP826

**Example:**

SCM394-1200Z04R-R0300HA-HP826



Dimensions in mm.

For cutting data recommendations, see chapter "Technical Appendix".  
Special designs and other coatings available upon request.

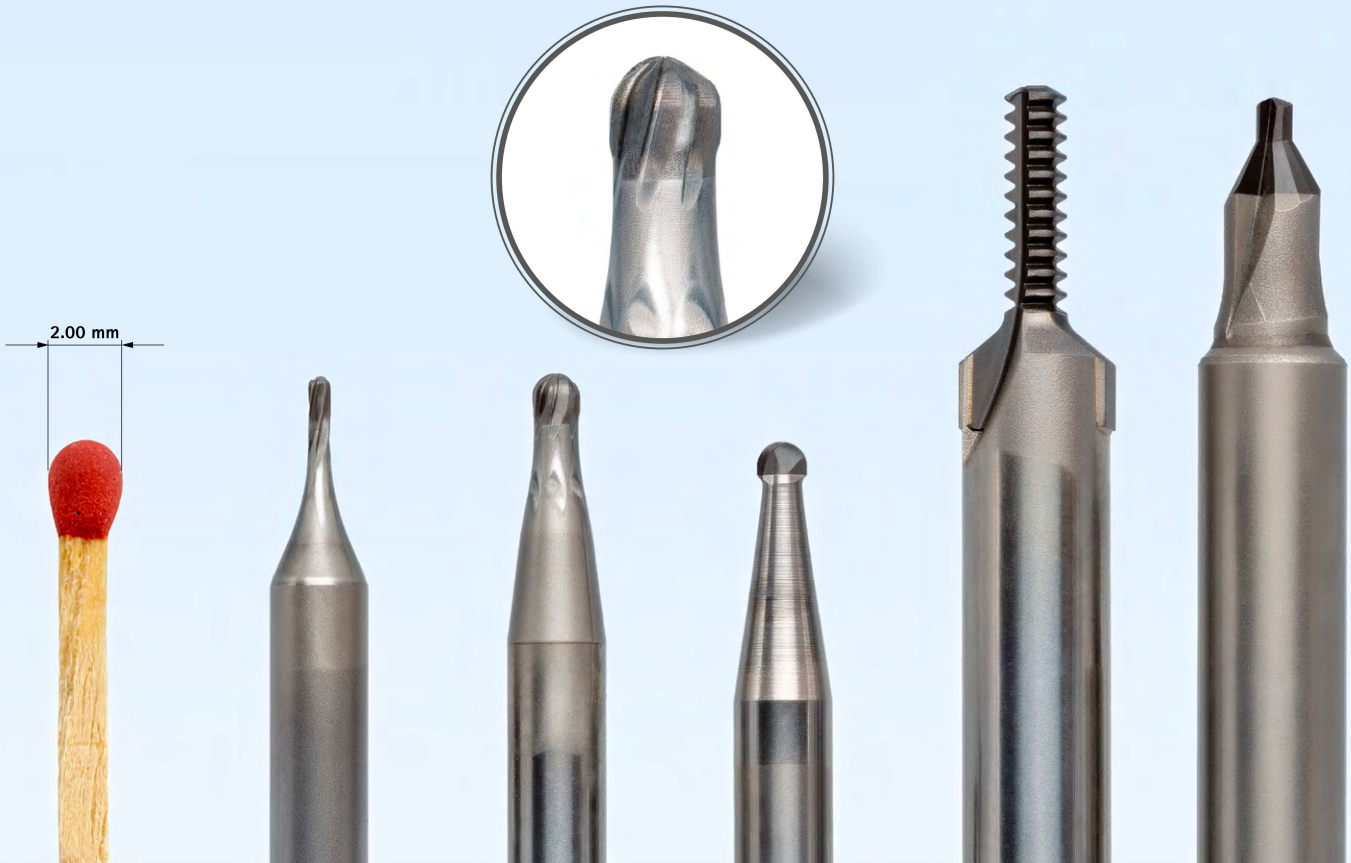

# PCD FULL HEAD TOOL

## Machining hard-brittle workpiece materials

To machine punches and die moulds, tools with diameters of less than 6 mm are mostly used. Full-head PCD is used to execute these tool dimensions in PCD since smaller milling cutters have no room for brazed-on cutting edges and their substructure.

With a new geometry, number of cutting edges and arrangement, MAPAL makes it possible to machine hard-brittle workpiece materials with diameters from 0.8 to 6 mm with these tools. In addition to carbide, hard-brittle workpiece materials also include zirconia, a

ceramic material used in dental technology. PCD milling cutters are also an alternative to solid carbide in this area.

## Comparison: Milling a solid carbide stencil

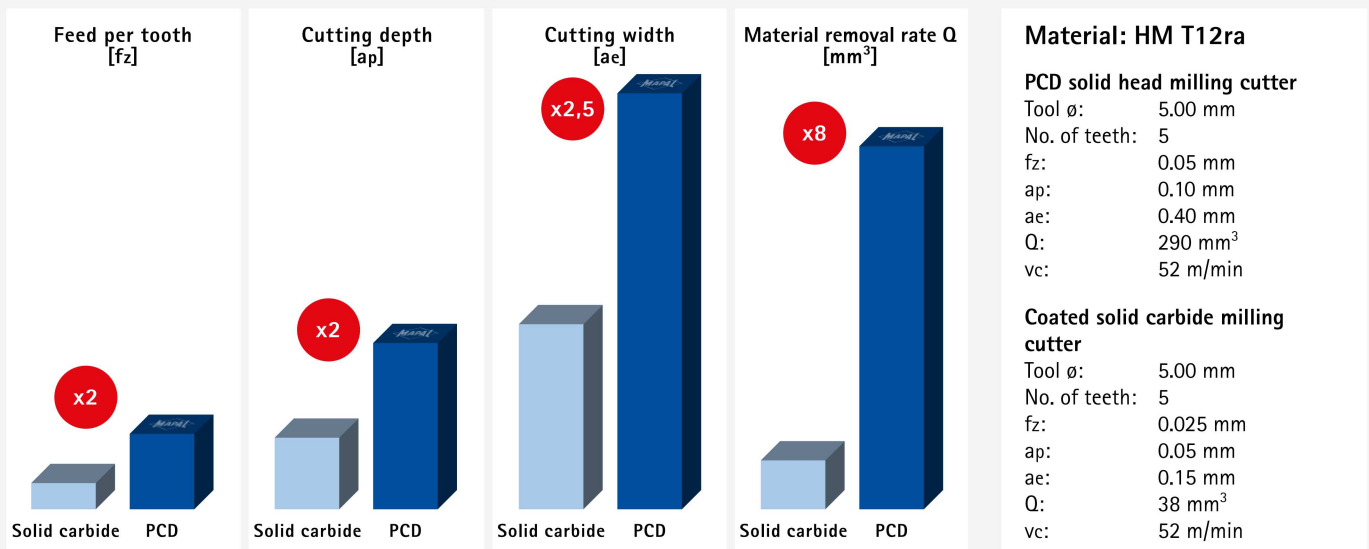





# CUSTOM-MADE PCD SOLID HEAD MILLING CUTTER



In the die & mould sector, deep-drawing dies are often made from durable carbide. Machining them by die-sinking or grinding is tedious. With new PCD solid head tools, MAPAL is extending the possibility of machining carbide and other hard-brittle materials to smaller diameters.

## CUSTOMISED SPECIAL SOLUTIONS

- PCD solid head tools available in diameter range from 0.8 to 6 mm
- Individual dimensions
- Variety of geometries
- Different numbers of teeth
- Tools specially adapted to the application

## ADVANTAGES

- Longer tool life with shorter process times
- 100% higher feeds per tooth with 8 times higher material removal rates compared to coated solid carbide
- Double cutting depths can be achieved with 2.5 times the cutting width



# Face milling cutter

## Face milling cutter with indexable inserts

Material suitability								Manufacturing processes			Process conditions		Application											
P	M	K	N	C	S	H																		
★	☐						■	■		■	■	■												
■	★	★					■	■		■	☐	■												
■		■					■	☐		■	☐	■												
			★						■	■	■	■												

## Face milling cutter with PCD milling inserts

Material suitability								Manufacturing processes			Process conditions		Application											
P	M	K	N	C	S	H																		
			■	☐			☐	■	■	■	■	■	■											
			■	☐			★	★	■	■	■	■	■											
			■	☐				☐	■	■	■	■	■											
			■	☐					★	■	■	■	■											
			■	☐					■	■		■	■											
			■	☐				☐	■	■	■	■	■											
			■				■	■	■	■	■	■	■	■										
			■	☐			☐	■	■	■	■	■	■											

Step 1:  
Type of milling cutter



Step 2:  
Material suitability



Step 3:  
Manufacturing processes



Step 4:  
Process conditions



Step 5:  
Application

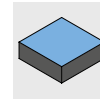

Step 6:  
Design



	Technical design						Tool body				Indexable insert / Milling cartridge			
	$\varnothing$ [mm]	$a_p$ max. [mm]	Cutting edges	Contact angle	Technology		Product name	Design	Main catalogue	Page	Product name		Main catalogue	Page
	63 - 200	5	8	45°	Radial	✓**	NeoMill-8-Face		✓		OFMT07		✓	
	63 - 200	4	16	45°	Radial	✓**	NeoMill-16-Face		✓		ONKU07		✓	
	80 - 200	8	4	45°	Tangential	✓	TGMill-4-Face45		✓		LTHU15		✓	
	50 - 315	Up to 2.5	4	90°	Tangential	✓	NeoMill-T-Finish <sup>N</sup>			124	CTH_09 <sup>+</sup>			131

	Technical design						Tool body				Indexable insert / Milling cartridge			
	$\varnothing$ [mm]	$a_p$ max. [mm]	Chip removal	Coolant supply		Can be reground	Product name	Design	Main catalogue	Page	Product name		Main catalogue	Page
			Cutting edge	Central										
	50 - 250	5	Replaceable chip deflector		✓	✓	PowerMill		✓		PMC with face milling insert		✓	
	50 - 400	5	Integrated chip deflector	✓		✓	PowerMill-Blue		✓		PBC with face milling insert		✓	
	50 - 250	3	Integrated chip deflector		✓		EcoMill		✓		EMC with face milling insert		✓	
	32 - 400	2	Integrated chip deflector	✓			EcoMill-Blue		✓		EBC with face milling insert		✓	
	50 - 200	1	Integrated chip deflector	✓			RapidMill-Blue		✓		RBC with face milling insert		✓	
	63 - 160	3			✓		FlyCutter		✓		FMC with face milling insert		✓	
	32 - 80	10		✓		✓	FaceMill-Diamond-ES <sup>N</sup>			132	brazed			
	40 - 125	10		✓		✓	FaceMill-Diamond		✓		brazed			

\* \*in the case of heat-resistant cast steel  
\*\* up to  $\varnothing$  125 mm:



# Shoulder milling cutter

Shoulder milling cutter with indexable inserts

Material suitability								Manufacturing processes			Process conditions		Application										
P	M	K	N	C	S	H																	
■	■						■	■		■	■	■	■	■			■	■	■				
■	■	■					■	■		■	■	■	■	■			■	■	■				
						★				■	■		■	■	■				■				
■		■	■				■	■		■	■	■	■	■			■	■	■				
■	★	■					■	■		■	■	■	■										
★	■						■	■		■	■	■	■				■						
■	■	★					■	■		■	■	■	■										
			★				■	■		■	■	■	■										
■	■	■					■	■		■	■	■	■										
			★				■	■		■	■	■	■						■	■			■

Shoulder milling cutter with PCD milling cartridges

Material suitability								Manufacturing processes			Process conditions		Application										
P	M	K	N	C	S	H																	
			★	■			■	■	■	■	■	■	■										

★ 1st choice    ■ highly suitable    ■ suitable in some situations

Step 1:  
Type of milling cutter



Step 2:  
Material suitability



Step 3:  
Manufacturing processes



Step 4:  
Process conditions



Step 5:  
Application

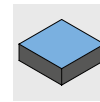

Step 6:  
Design



	Technical design						Tool body				Indexable insert			
	$\varnothing$ [mm]	$a_p$ max. [mm]	Cutting edges	Contact angle	Technology		Product name	Design	Main catalogue	Page	Product name		Main catalogue	Page
	10 - 50	5,2	2	90°	Radial	✓	NeoMill-2-HiFeed90		✓		LPMX06		✓	
	20 - 63	11	2	90°	Radial	✓*	NeoMill-2-Corner		✓		AOKT12		✓	
	10 - 100	10	2	90°	Radial	✓	NeoMill-Titan-2-Corner <sup>N</sup>			142	XPKT11 <sup>N</sup>			147
	25 - 160	17	2	90°	Radial	✓	NeoMill-2-HiFeed90		✓		LD_X18		✓	
	25 - 100	10	4	90°	Radial	✓*	NeoMill-4-Corner		✓		ANMU12		✓	
	40 - 160	8	4	90°	Radial	✓*	NeoMill-4S-Corner		✓		SDKT10		✓	
	50 - 160	8	8	90°	Radial	✓*	NeoMill-8-Corner		✓		SNMU12		✓	
	63 - 200	7	2	90°	Tangential	✓	TGMill-2-Corner		✓		CTHD09		✓	
	63 - 200	7	4	90°	Tangential	✓	TGMill-4-Corner		✓		CT_Q09			78
	32 - 80	13	2	90°	Radial	✓	NeoMill-Alu-QBig <sup>N</sup>			134	XDHT15 <sup>N</sup>			141

	Technical design						Tool body				Milling cartridge			
	$\varnothing$ [mm]	$a_p$ max. [mm]	Chip removal	Coolant supply		Can be reground	Product name	Design	Main catalogue	Page	Product name		Main catalogue	Page
	32 - 400	1 - 10**	**	✓**	✓**	✓**	Milling cutter with PCD milling cartridges		✓		Milling cartridge with corner milling blade		✓	

\* \*in the case of heat-resistant cast steel  
\*\* up to  $\varnothing$  125 mm:



## High-feed milling cutter

Material suitability								Manufacturing processes			Process conditions		Application											
P	M	K	N	C	S	H																		
★	■					■	■				■	■	■	■	■					■	■	■	■	■
★	■	★	■			■	■	■			■	■	■	■	■					■	■	■	■	■
★	■					■	■	■	■		■	■	■	■	■					■	■	■	■	■
★	■	★	■			■	■	■	■		■	■	■	■	■					■	■	■	■	■
★	■	★	■			■	■	■	■		■	■	■	■	■					■	■	■	■	■
★	■	★				■	■	■	■		■	■	■	■	■					■	■	■	■	■

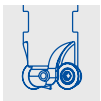

## Copy milling cutter

Material suitability								Manufacturing processes			Process conditions		Application											
P	M	K	N	C	S	H																		
■	■	■				■	■	■			■	■	■						■	■	■	■	■	■
■	■	■				■	■	■			■	■	■						■	■	■	■	■	■
★	★	★				■	■	■			■	■	■						■	■	■	■	■	■
■	■	■				■	■	■			■	■	■						■	■	■	■	■	■

★ 1st choice    ■ highly suitable    ■ suitable in some situations

Step 1:  
Type of milling cutter



Step 2:  
Material suitability



Step 3:  
Manufacturing processes



Step 4:  
Process conditions



Step 5:  
Application

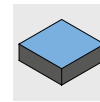

Step 6:  
Design



	Technical design						Tool body				Indexable insert			
	$\emptyset$ [mm]	$a_p$ max. [mm]	Cutting edges	Contact angle	Technology		Product name	Design	Main catalogue	Page	Product name		Main catalogue	Page
	10 - 50	0,7	2	High feed	Radial	✓	NeoMill-2-HiFeed90		✓		LPMX06		✓	
	16 - 80	1,4	2	High feed	Radial	✓	NeoMill-2-HiFeed90		✓		LD_X10		✓	
	16 - 35	1	4	High feed	Radial	✓	NeoMill-4-HiFeed90		✓	149	SD_06	✓	154	
	25 - 80	1,5	4	High feed	Radial	✓	NeoMill-4-HiFeed90		✓	150	SD_10	✓	154	
	50 - 125	2,4	4	High feed	Radial	✓	NeoMill-4-HiFeed90		✓	152	SD_14	✓	154	
	80 - 200	3,5	4	High feed	Radial	✓	NeoMill-4-HiFeed90		✓	153	SD_18	✓	154	

	Technical design						Tool body				Indexable insert / Milling cartridge			
	$\emptyset$ [mm]	$a_p$ max. [mm]	Cutting edges	Contact angle	Technology		Product name	Design	Main catalogue	Page	Product name		Main catalogue	Page
	15 - 16	3,5	*	0°	Radial	✓	NeoMill-ISO-360		✓		RD_07		✓	
	20 - 52	5	*	0°	Radial	✓	NeoMill-ISO-360		✓		RD_10		✓	
	42 - 80	6	*	0°	Radial	✓	NeoMill-ISO-360		✓		RD_12		✓	
	50 - 160	8	*	0°	Radial	✓	NeoMill-ISO-360		✓		RD_16		✓	

\* depending on  $a_p$  max.



## Shell end milling cutter

Material suitability								Manufacturing processes			Process conditions		Application										
P	M	K	N	C	S	H																	
■	■	★					■	■		■	■		■	■	■								
■	■	■					■	■		■	■		■	■	■								
					★					■	■		■	■	■								
★	★	■					■	■		■	■		■	■	■								
			■				■	■		■	■		■	■	■								



## Helix milling cutters

Material suitability								Manufacturing processes			Process conditions		Application										
P	M	K	N	C	S	H																	
★	★	★					■	■		■	■		■					■	■				
			★				■	■		■	■		■					■	■				



## Disc milling cutter

Material suitability								Manufacturing processes			Process conditions		Application											
P	M	K	N	C	S	H																		
★	★	★					■	■	■	■	■		■	■										
			★				■	■	■	■	■		■	■										

★ 1st choice    ■ highly suitable    ■ suitable in some situations



Step 1:  
Type of milling cutter



Step 2:  
Material suitability



Step 3:  
Manufacturing processes



Step 4:  
Process conditions



Step 5:  
Application

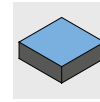

Step 6:  
Design



	Technical design						Tool body				Indexable insert			
	$\emptyset$ [mm]	$a_p$ max. [mm]	Cutting edges	Contact angle	Technology		Product name	Design	Main catalogue	Page	Product name		Main catalogue	Page
	32 - 63	62	4	90°	Radial	✓	NeoMill-4-Shell		✓		ANMU12		✓	
	25 - 40	62	2	90°	Radial	✓	NeoMill-2-Shell		✓		AOKT12		✓	
	32 - 80	57	2	90°	Radial	✓	NeoMill-Titan-2-Shell <sup>N</sup>			144	XPKT11 <sup>N</sup>			147
	63 - 100	75	4	90°	Tangen- tial	✓	TGMill-4-Shell <sup>+</sup>		✓	155	CTHQ09 <sup>+</sup>		✓	156
	63 - 100	75	2	90°	Tangen- tial	✓	TGMill-2-Shell		✓		CTHD09		✓	

	Technical design						Tool body				Indexable insert			
	$\emptyset$ [mm]	$a_p$ max. [mm]	Cutting edges	Contact angle	Technology		Product name	Design	Main catalogue	Page	Product name		Main catalogue	Page
	80 - 125	35	4	90°	Tangen- tial	✓	TGMill-4-Helical		✓		CTHQ09		✓	
	80 - 125	35	2	90°	Tangen- tial	✓	TGMill-2-Helical		✓		CTHD09		✓	

	Technical design						Tool body				Indexable insert			
	$\emptyset$ [mm]	$a_p$ max. [mm]	Cutting edges	Contact angle	Technology		Product name	Design	Main catalogue	Page	Product name		Main catalogue	Page
	100 - 200	17	4	90°	Tangen- tial		TGMill-4-Disc		✓		CTHQ09		✓	
	100 - 200	17	2	90°	Tangen- tial		TGMill-2-Disc		✓		CTHD09		✓	

<sup>N</sup> New

<sup>+</sup> Range additions

# Cutting materials overview: Selection of the correct cutting material

The cutting materials from MAPAL cover a wide spectrum of wear resistance and ductility. The designation of the cutting material indicates the level of ductility; the ductility increases as the number increases.

PVD-coated cutting materials (HP...) are the first choice for milling K, P and M workpiece materials. These cutting materials have the longest tool life. If high cutting speeds are to be realised, CVD-coated cutting materials (HC...) should be selected.

For non-ferrous workpiece materials, uncoated and coated carbide grades (HU.../HP...) are the first choice. From a silicon content of  $\geq 12\%$ , PCD (PU...) is recommended due to increasing abrasiveness. With PCD, maximum tool life is achievable, which is why this cutting material is particularly suitable for large series.

**Example:** HP675 is more ductile than HP665 (the more ductile the cutting material, the less resistant it is to wear).

1. Choose your workpiece material in accordance with the MMGs (MAPAL Machining Groups).
2. Depending on the tool type, select the material type below the desired workpiece material in the corresponding **"Cutting materials overview [...]"** table.
3. Depending on the general conditions (see table **"General conditions"**), a wear-resistant or more ductile cutting material is to be selected.
4. If general conditions in the direction of the black arrow predominate and breakages cannot be prevented despite a ductile CVD grade, you should change to PVD-coated cutting materials.

### General conditions

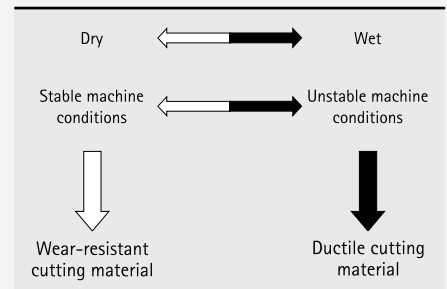

### Cutting materials overview for milling

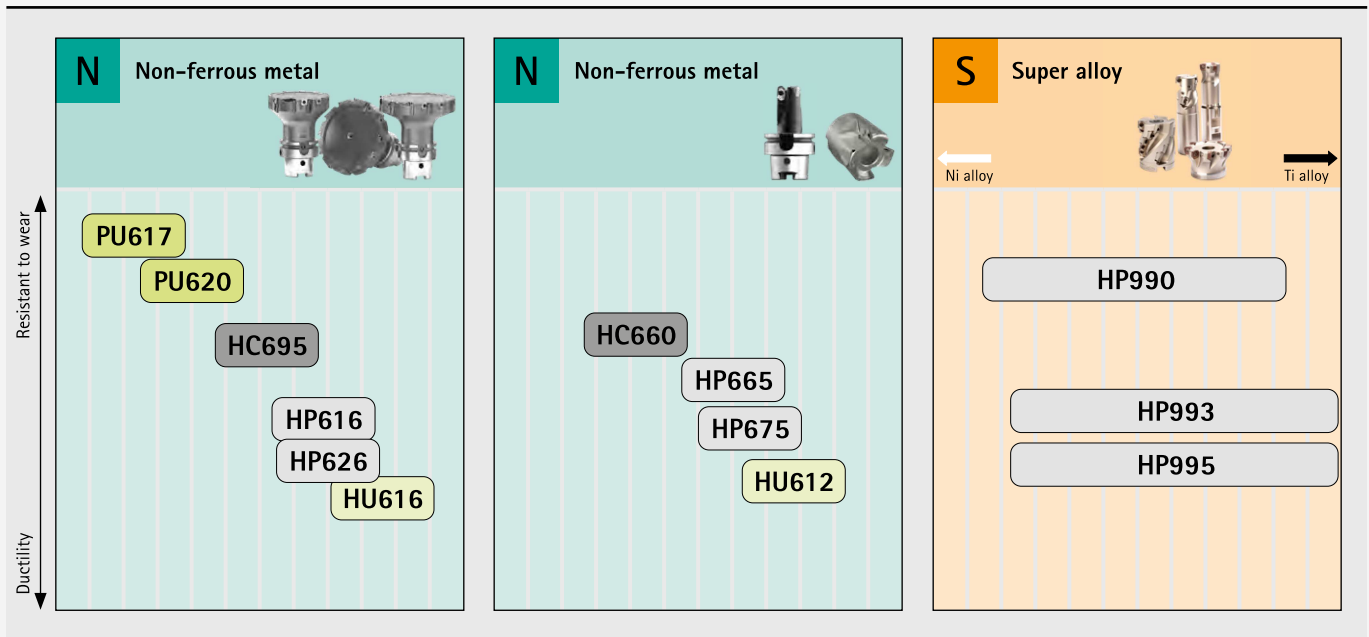

- CVD
- PVD
- PCD
- Uncoated

# Cutting Material Overview: Types and type description

## Milling cutters with indexable inserts

Cutting material	Name of cutting material	Coating composition	Colour of coating	Field of application	Recommended application	
Carbide	PVD-coated	HP616	TiB2	Silver	●	Wear resistant fine grain carbide with TiB2 coating is characterised by a high level of resistance to wear and excellent coating adhesion. In addition, the extremely smooth coating surface reduces the formation of built-up edges.
		HP626	AlTiN	Grey anthracite	●	Fine grain carbide with balanced wear resistance. The thermally resistant AlTiN-based PVD coating is characterised by its low sticking tendency.
		HP665	ta-C	Rainbow	●	This cutting material combines excellent coating smoothness with extremely sharp cutting edge for achieving the highest surface finish in aluminium wrought alloys.
		HP968	AlTiN	Black anthracite	●	PVD-coated fine grain carbide grade for medium machining and for roughing GJL, GJV and GJS. Suitable for wet or dry machining at medium to high cutting speeds.
		HP675	TiB2	Silver	●	The fine-grain carbides with PVD coating are characterised by a high level of resistance to wear and excellent coating adhesion. Suitable for the machining of aluminium cast alloys with an Si content of up to 12%.
		HP990	TiB2	Silver	●	PVD-coated universal carbide type for titanium machining at low to medium cutting speeds (30 – 50 m/min). The TiB2 coating is characterised by a high level of resistance to wear and excellent coating adhesion. In addition, the extremely smooth coating surface reduces the formation of built-up edges.
		HP993	TiB2	Silver	●	PVD-coated carbide types that are considered the first choice in relation to price and performance for titanium machining at high cutting speeds (40 – 70 m/min). The TiB2 coating is characterised by a high level of resistance to wear and excellent coating adhesion. In addition, the extremely smooth coating surface reduces the formation of built-up edges.
		HP995	TiB2	Silver	●	PVD-coated carbide types with high thermal stability that are considered the first choice in relation to price and performance for titanium machining at high cutting speeds (40 – 70 m/min) together with maximum tool life. The TiB2 coating is characterised by a high level of resistance to wear and excellent coating adhesion. In addition, the extremely smooth coating surface reduces the formation of built-up edges.
	CVD-coated	HC660	Diamond	Black anthracite	●	CVD-diamond-coated carbide for achieving maximum tool life in abrasive NE metals and non-metallic workpiece materials.
		HC695	Diamond	Black anthracite	●	Fine-grain carbide with CVD diamond coating for machining aluminium.
	Uncoated	HU612	-	-	●	Uncoated carbide grade for the general machining of aluminium wrought alloys.
HU616		-	-	●	Fine grain carbide with very smooth surface for the general machining of aluminium wrought alloys and aluminium cast alloys with Si contents < 3%.	
PCD	PU617	-	-	●	PCD grade with medium particle size for semi-machining in aluminium and for machining very abrasive materials, such as AISi17.	
	PU620	-	-	●	PCD grade with medium particle size for semi-machining in aluminium and for machining very abrasive materials, such as AISi17.	

Field of application: ● General machining

# NeoMill®-T-Finish

## Finishing with the highest accuracy and without adjustment

The NeoMill-T-Finish indexable insert milling cutter is designed for economical and process-reliable finish machining in series production. The milling cutter is impressive thanks to its very easy handling: The cutting edges can be interchanged on site and do not need to be adjusted – MAPAL calls this principle Plug & Mill. Thank to its high cutting material variance, the NeoMill-T-Finish can be used for all aluminium alloys as well as sand casting. The cutting edge assembly ensures quiet running, low burr formation, even wear and tear, and therefore the best surfaces.



**Wiper (geometry)**

with a large operating radius for an excellent surface finish

**NeoMill-T-Finish**

Face-milling finishing for aluminium materials

**Tool adapter**

Monolithic or adaptive

**Finish cutting edge**

No tool adjustment necessary → Plug & Mill

**Cooling**

Emulsion, MQL, dry or air cooling

**Peripheral cutting edge**

Pre-cutting stage – low burr formation

**Tool body**

Individual design → maximum efficacy and economic efficiency

**Cutting materials**

Cutting material variants for all applications in aluminium

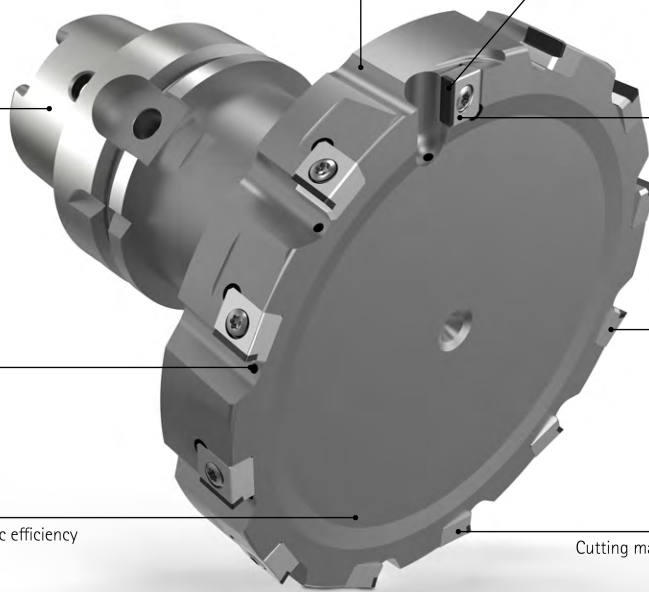

### Features

**Preferred series available from stock:**

- Diameter range: 80.00 - 160.00 mm
- Connection: Milling cutter arbor
- Design in accordance with effective facing diameter for more finish width

**Configurable features:**

- Diameter range: 50.00 - 315.00 mm
- Connection: HSK, SK, CAT, BT
- Connection: Milling cutter arbor
- Number of teeth: For maximum efficiency and economy, tool configuration and cutting data are defined for each application

### Tool life [units]

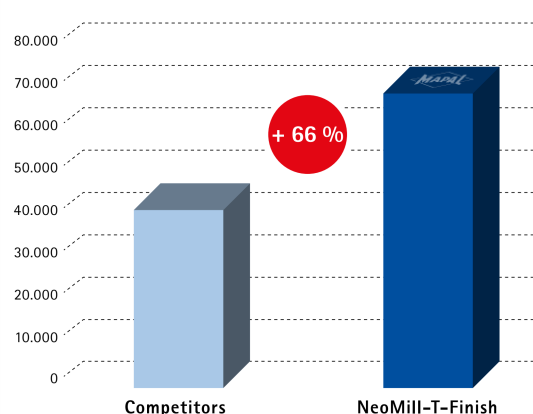

**Workpiece: Cylinder head**

- Material: AlSi7Cu0.5
- Tool ø: 125 mm
- $v_c$ : 2,513 m/min
- $f_u$ : 1.8 mm
- $a_p$ : 0.3 mm
- $a_e$ : varies depending on part



Scan the QR code for more information,  
or click on the link: [www.mapal.com](http://www.mapal.com)

# NeoMill®-T-Finish

Finish face milling cutter, with tangential technology  
CTH\_09

**Design:**

Diameter of milling cutter: 50.00 - 315.00 mm

Max. no. of cutting edges: 5 - 17

Surface quality:  $R_a = 0.3 \mu\text{m}$  /

$R_z = 1.5 \mu\text{m}$

Special features: No adjustment necessary, very good surface value, Plug & Mill

**Application:**

Universal face milling cutter for finishing with up to 2.5 mm stock removal.

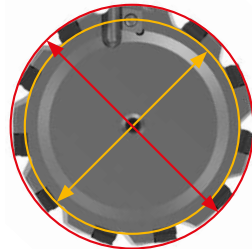
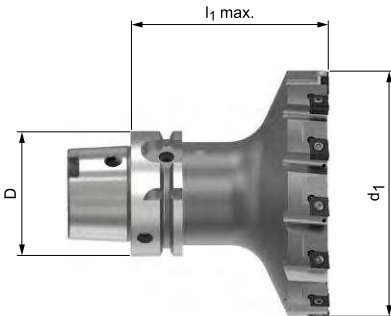

— Nominal diameter [ $d_1$ ]  
— Effective facing diameter



**Dimensions of configurable series | With HSK-A connection, to outer diameter**

Dimensions			$Z_{\text{eff max.}}$ [incl. 1 wiper]	Connection
$d_1$	Facing diameter	$l_1 \text{ max.}$		
50,00	38,50	D x 2,5	5	HSK, SK, CAT, BT
63,00	51,50		7	
80,00	68,60		9	
100,00	88,60		11	
125,00	113,60		13	
160,00	148,60		17	
200,00	188,60		17	
250,00	238,60		17	
315,00	303,60		17	

**Dimensions of configurable series | With HSK-A connection in accordance with effective facing diameter for more finish width**

Dimensions			$Z_{\text{eff max.}}$ [incl. 1 wiper]	Connection
$d_1$	Facing diameter	$l_1 \text{ max.}$		
61,50	50,00	D x 2,5	5	HSK, SK, CAT, BT
74,50	63,00		7	
91,50	80,00		9	
111,50	100,00		11	
136,50	125,00		13	
171,50	160,00		17	
211,50	200,00		17	
261,50	250,00		17	
326,50	315,00		17	

**Configurable features**



**Diameter:**  
50.00 mm - 315.00 mm



**Length:**  
Length up to l1 max. (D x 2.5) configurable



**Connection:**  
Different connections available  
(see right table)

**Number of teeth and feed rate:**

Diameter, length, number of teeth and cutting data are determined individually for each application, for maximum efficiency and economy.

**Maximum length l1 max. depending on the connection**

Connection	D Connection	l <sub>1</sub> max. (D x 2.5)
HSK-A 63 / C 63	63,00	157,500
HSK-A 80 / C 80	80,00	200,000
HSK-A 100 / C 100	100,00	250,000
SK40	44,45	111,125
SK50	69,85	174,625
CAT40	44,45	111,125
CAT50	69,85	174,625
BT40	44,45	111,125
BT50	69,85	174,625

**Example:**

T-Finish-1-050-090-A063-Z05R

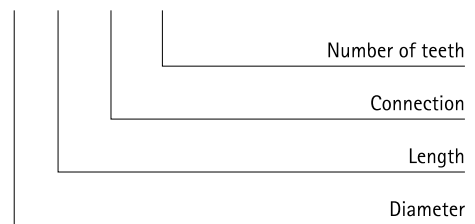

**Accessories**

	CTHQ09...	Indexable inserts	Page 131
	CTHD09...	Indexable inserts	Page 131
		Milling cutter arbor for milling cutter	Page 215

**Spare parts\***

	CTHQ09.. CTHD09..	Clamping screw M3,5x11-TX10-IP	Order no. 10105079
		Milling cutter clamping screw for milling cutter	Page 161

Dimensions in mm.

For cutting data recommendations, see chapter "Technical Appendix".

\*Included in scope of delivery.

Only use milling cutter with milling cutter arbor with enlarged face connection.

Do not use milling cutter arbors for milling cutters with longitudinal groove / cross slot with drive ring.

# NeoMill®-T-Finish

Finish face milling cutter, with tangential technology  
CTH\_09

**Design:**

Diameter of milling cutter: 50.00 - 315.00 mm

Max. no. of cutting edges: 5 - 17

Surface quality:  $R_a = 0.3 \mu\text{m}$  /  $R_z = 1.5 \mu\text{m}$

Special features: No adjustment necessary, very good surface value, Plug Et Mill

**Application:**

Universal face milling cutter for finishing with up to 2.5 mm stock removal.

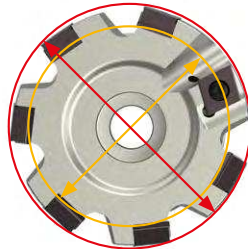
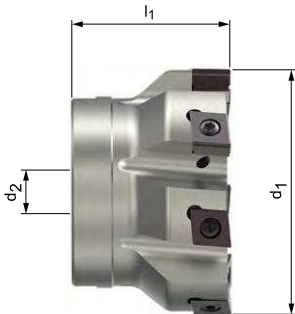

— Nominal diameter [d<sub>1</sub>]  
— Effective facing diameter



Preferred series available from stock | Milling cutter in accordance with effective facing diameter for more finish width

Dimensions				Z <sub>eff</sub> max. [incl. 1 wiper]	Specification	Order no.
d <sub>1</sub>	Facing diameter	l <sub>1</sub>	d <sub>2</sub>			
91,50	80,00	50,00	32,00	9	T-Finish-1-091-050-CA27-Z09R	31461790
111,50	100,00	50,00	32,00	11	T-Finish-1-111-050-CA32-Z11R	31461791
136,50	125,00	63,00	40,00	13	T-Finish-1-136-063-CA40-Z13R	31461792
171,50	160,00	63,00	40,00	17	T-Finish-1-171-063-CA40-Z17R	31461793

Dimensions configurable series | Milling cutter, to outer diameter

Dimensions				Z <sub>eff</sub> max. [incl. 1 wiper]
d <sub>1</sub>	Facing diameter	l <sub>1</sub>	d <sub>2</sub>	
50,00	38,50	40,00	22,00	5
63,00	51,50	40,00	22,00	7
80,00	68,60	50,00	27,00	9
100,00	88,60	50,00	32,00	11
125,00	113,60	63,00	40,00	13
160,00	148,60	63,00	40,00	17
200,00	188,60	63,00	60,00	17
250,00	238,60	63,00	60,00	17
315,00	303,60	80,00	60,00	17

Dimensions configurable series | Milling cutter in accordance with effective facing diameter for more finish width

Dimensions				Z <sub>eff</sub> max. [incl. 1 wiper]
d <sub>1</sub>	Facing diameter	l <sub>1</sub>	d <sub>2</sub>	
61,50	50,00	40,00	22,00	5
74,50	63,00	50,00	22,00	7
91,50	80,00	50,00	27,00	9
111,50	100,00	50,00	32,00	11
136,50	125,00	63,00	40,00	13
171,50	160,00	63,00	40,00	17
211,50	200,00	63,00	60,00	17
261,50	250,00	63,00	60,00	17
326,50	315,00	80,00	60,00	17



**Configurable features**



**Diameter:**  
50.00 mm - 315.00 mm



**Number of teeth and feed rate:**

Diameter, number of teeth and cutting data are determined individually for each application for maximum efficiency and economy.

**Example:**

T-Finish-1-050-040-CA22-Z05R

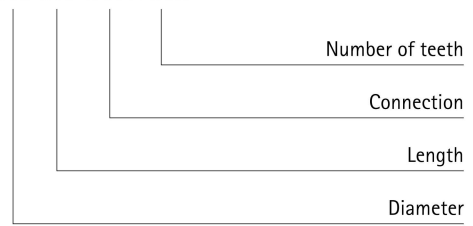

**Accessories**

	CTHQ09...	Indexable inserts	Page 131
	CTHD09...	Indexable inserts	Page 131
		Milling cutter arbor for milling cutter	Page 215

**Spare parts\***

	CTHQ09... CTHD09..	Clamping screw M3,5x11-TX10-IP	Order no. 10105079
		Milling cutter clamping screw for milling cutter	Page 161

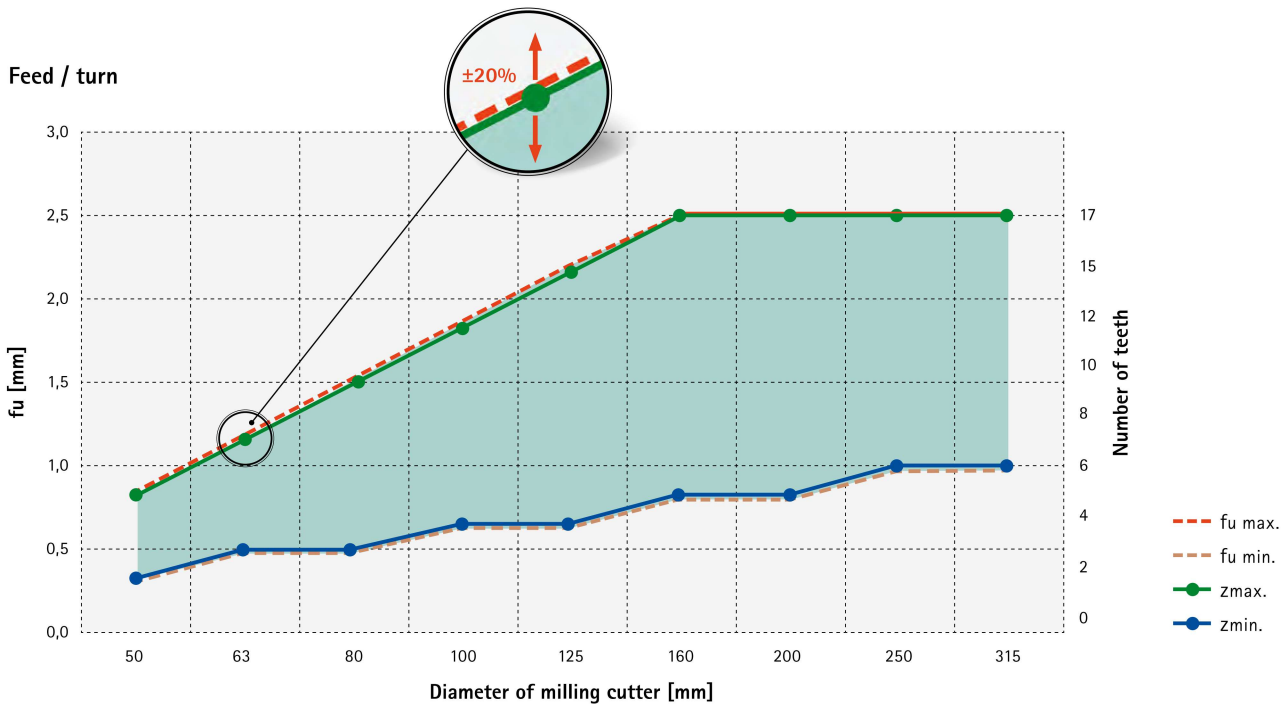

fu = feed/turn | fz = ideal feed is designed with 0.17 mm and can be varied according to the machining operation

Dimensions in mm.

For cutting data recommendations, see chapter "Technical Appendix".

\*Included in scope of delivery.

Only use milling cutter with milling cutter arbor with enlarged face connection.

Do not use milling cutter arbors for milling cutters with longitudinal groove / cross slot with drive ring.

# Cutting materials overview: Selecting the right cutting material

Workpiece material	<b>N Aluminium</b>					
Type of cast	Wrought alloys		Sand casting		Pressure die casting / permanent mould casting	
Material	AlSi 0.1 – 7		AlSi 7 – 12 / All aluminium variants for sand casting		All aluminium variants < 12% Silicon	
Lot size	Small to medium lot sizes			Medium to large lot sizes		Series production
	< 1,000 parts / month			~1,000 – 10,000 month		> 10,000 parts per month / Series production
Other	Cost savings due to PCD handling errors			Lowest total costs cpp (machine and cutting material costs)		Longest tool life, superior surface finishes
Cutting data	200 – 500 m/min		200 – 700 m/min		400 – 1,800 m/min	
Cutting material type	HU616	HP616	HP626	HC695	PU617	PU620

## Overview of wiper geometry

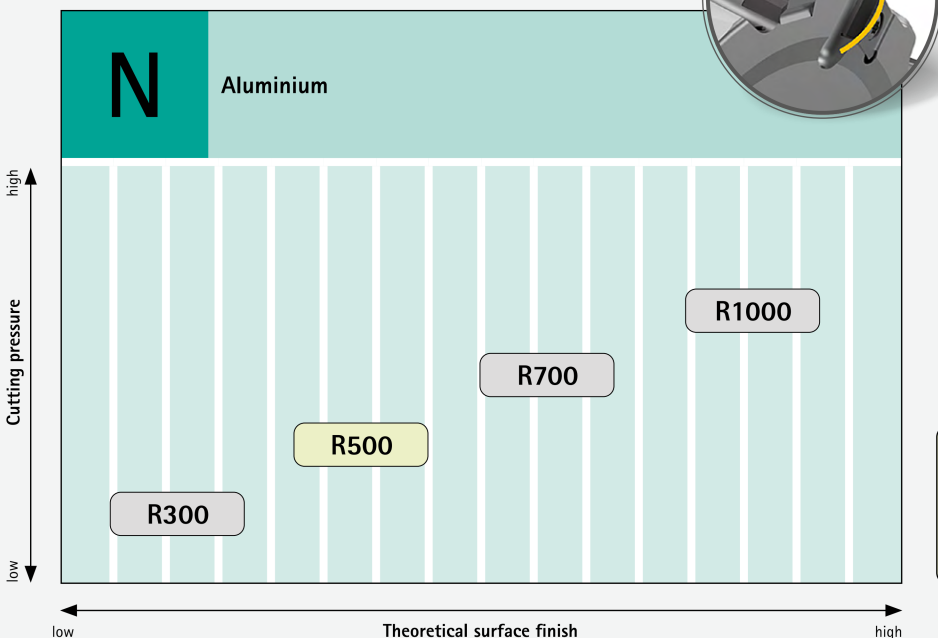

**Recommendation:**  
1st choice R500  
Ideal ratio of theoretical surface finish to low cutting pressure.

# CTHQ

Tangential indexable inserts – cutting on the periphery  
 Carbide four-edged – PCD single-edged

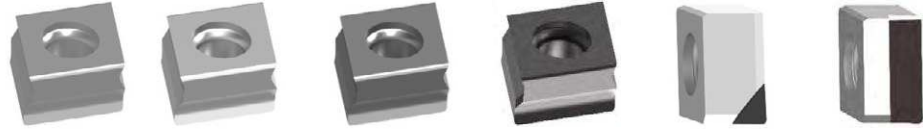

Workpiece material	<b>N</b> Aluminium						
Substrate	Carbide				PCD		
Coating	–		PVD		CVD	–	–
Cutting material type	HU616	HP616		HP626	HC695	PU617	PU617
Cutting edge design	H20	H20		H20	H20	A60	A80
<b>CTHQ09</b>	<b><math>a_p</math> max. [mm]</b>						
CTHQ090504...R-...	*	31389667	31389680	31389683	31091137	31418394	31418397
CTHQ090508...R-...	*	31316862	31389687	31389689	31126185	31389694	31418398

# CTHD

Tangential indexable inserts – face-side wiper blade  
 Carbide double-edged – PCD single-edged



Workpiece material	<b>N</b> Aluminium						
Substrate	Carbide				PCD		
Coating	PVD				–		
Cutting material type	HP616		HP626		PU620		
Cutting edge design	D00		D00		D80		
<b>CTHD09</b>	<b><math>a_p</math> max. [mm]</b>						
CTHD09T304...L00M300-	R300	*	31389725	31389729	31389698		
CTHD09T304...L00M500-	R500	*	31389726	31389731	31389720		
CTHD09T304...L00M700-	R700	*	31389727	31389732	31389722		
CTHD09T304...L00M1T0-	R1000	*	31389728	31389733	31389724		

**Recommendation:** Whenever the indexable inserts are changed, replace the clamping screws as well.  
 \*  $a_p$  max. depends on the type of milling cutter and application.

# FaceMill-Diamond-ES

## The versatile PCD face milling cutter for small quantities

The new FaceMill-Diamond-ES is a versatile entry-level addition to the PCD face milling cutters in MAPAL's FaceMill-Diamond family. The milling cutters have fewer cutting edges than the established FaceMill-Diamond tools, making them a more cost-effective and "Economical Solution".

**1 Universal lead 0.1 x 45°**

- Suitable for many different machining operations with very good surface finishes

**2 Generous chip space**

- Safe removal of chips even under peak loads

**3 Cooling directly at the cutting edge**

- Avoids overheating and abrasion on the tool body

**4 Standardised milling cutter arbor**

- Highest flexibility due to modularity

**5 Brazed PCD cutting edges**

- Cutting edges made of PCD for long tool lives
- Large cutting depth up to 10 mm

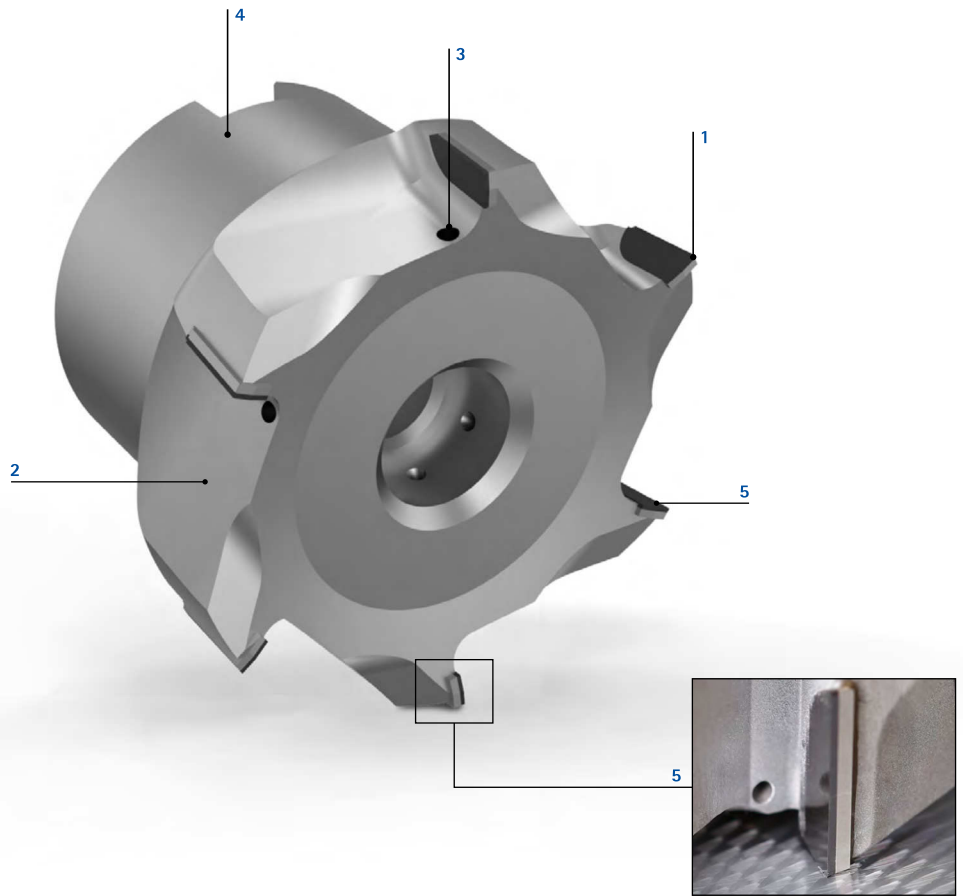

### Features

**Dimensions:**

- Number of cutting edges: 4 - 7
- Modular PCD milling cutter





**Preferred series available from stock:**

- Ø area: 32 - 80 mm
- Lead: 0.1 mm x 45°

**Other geometries available at short notice:**

- Chamfer size: 0.1-1.0 mm x 45°
- Radius: 0.1 - 1.5 mm

### Recommendation for use | Value

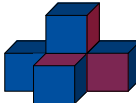
	FaceMill-Diamond	FaceMill-Diamond-ES
<b>Application</b>	 	 
All-rounder for high part variance	● ● ● ● ●	● ● ● ● ●
Daily production volume	● ● ● ● ●	● ● ● ● ●
Contact time on the part	 Contact time: Long, straight travel distances	 Contact time: Multiple, short travel distances

# FaceMill-Diamond-ES

PCD face milling cutter, with internal cooling  
SHM581

**Design:**

Diameter of milling cutter: 32.00 - 80.00 mm  
Cutting material: PU611  
Number of cutting edges: 4 - 7  
Axis angle: 6° positive  
Surface quality:  $R_z \leq 10$   
Special features: Coolant outlets directly at the cutting edge

**Application:**

Plug & Mill. Universal milling cutter for roughing, finishing und full slot milling up to max. 10 mm cutting depth. Plunge angle max. 1°.

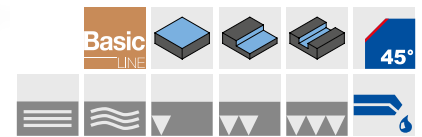
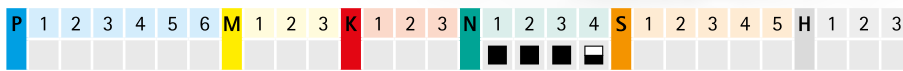
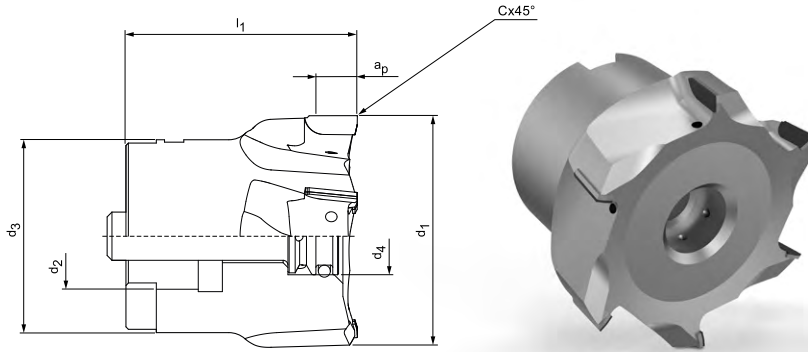

Preferred series available from stock | Milling cutter

Dimensions						Z <sub>eff</sub>	a <sub>p</sub> max.	Plunge angle	Weight [kg]	Max. operating speed [min <sup>-1</sup> ]	Specification	Order no.
d <sub>1</sub>	d <sub>2</sub>	d <sub>3</sub>	d <sub>4</sub>	l <sub>1</sub>	Cx45°							
32	16	34	13	40	0,1	4	10	1°	0,5	31.000	SHM581-032BZ04R-F0010CA-PU611	31312566
40	16	34	13	40	0,1	4	10	1°	0,5	31.000	SHM581-040BZ04R-F0010CA-PU611	31312567
50	22	40	16	48	0,1	5	10	1°	0,5	31.000	SHM581-050BZ05R-F0010CA-PU611	31312568
63	22	40	16	48	0,1	6	10	1°	0,6	31.000	SHM581-063BZ06R-F0010CA-PU611	31312569
80	27	52,5	34	50	0,1	7	10	1°	1,0	30.000	SHM581-080BZ07R-F0010CA-PU611	31312581

Cutting edges with straight geometries

Cutting edges with other geometries available at short notice.  
In graduations of 0.1 mm freely selectable:



Radius: 0.1 - 1.5 mm



Chamfer size: 0.1 - 1.0 mm  
Additional angles available upon request

Custom tools made to order

Customised special designs are available on request:

- Individual dimensions
- Different numbers of teeth
- Insert
- Different cutting materials
- Counter-clockwise design

Accessories

	Milling cutter arbor for milling cutter	Page 215
---	---	----------

Spare parts\*

	d <sub>1</sub>	Fastening screw with coolant delivery	Order no.
	32	SW6 - 15 Nm	31318525
	40	SW6 - 15 Nm	31318525
	50	SW8 - 20 Nm	30984018
	63	SW10 - 50 Nm	30984019
	80	SW12 - 80 Nm	30984030

Dimensions in mm.  
For cutting data recommendations, see chapter "Technical Appendix".

\*Included in scope of delivery.  
The maximum operating speeds refer only to the cutting edge system.

# NeoMill®-Alu-QBig

## Fast material removal rates with low cutting forces and high-quality surface finishes

The new indexable insert cutters NeoMill-Alu-QBig are a highly economical solution for larger diameters. They offer maximum efficiency with a material removal rate of up to 18 litres per minute. Thanks to ultra-strong bolts and a fine-balancing system, this tool boasts a spindle speed of up to 35,000 rpm at a tool diameter of 50 mm. The combination of low cutting forces and high-precision indexable inserts enables high-quality surface finishes. Internal cooling and very large chip spaces ensure optimal heat dissipation and chip removal.

### 1 New MAPAL system blade

- Cutting edge up to 13 mm

### 2 Polished rake face and highly positive rake angle

- Less friction resistance and heat generation

### 3 Prismatic insert seat and special clamping screw

- Cutting edge has a firm seat, even at spindle speeds of 35,000 rpm

### 4 Fine-balancing system

- For quiet running and high-quality surface finish
- Longer tool life



## Features

- Highest speeds due to plate design and high-strength clamping screw
- High ramp angle max. 10° at 32 mm tool diameter
- Surface finish roughing ( $R_a$  0.8 /  $R_z$  4)

### XDHT indexable insert:

- Uncoated / PVD-coated / PVD-diamond-coated
- Corner radius 0.8 | 1.6 | 2.0 | 3.0 | 4.0 mm
- Cutting edge length up to 13.0 mm

### Available variants:

- Monolithic  $\varnothing$  32 to  $\varnothing$  63 mm
- Monolithic  $\varnothing$  40 to  $\varnothing$  80 mm

## Tool life [min]

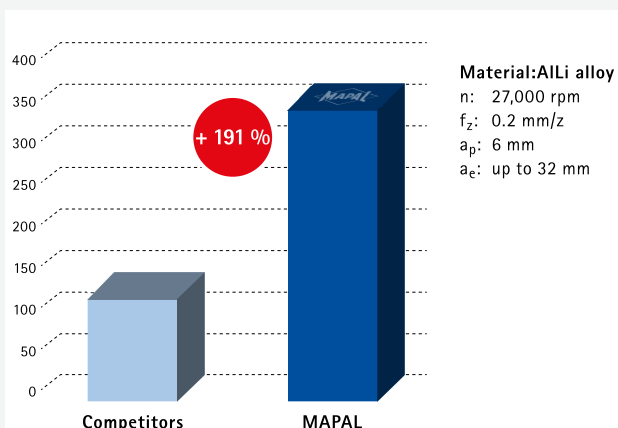

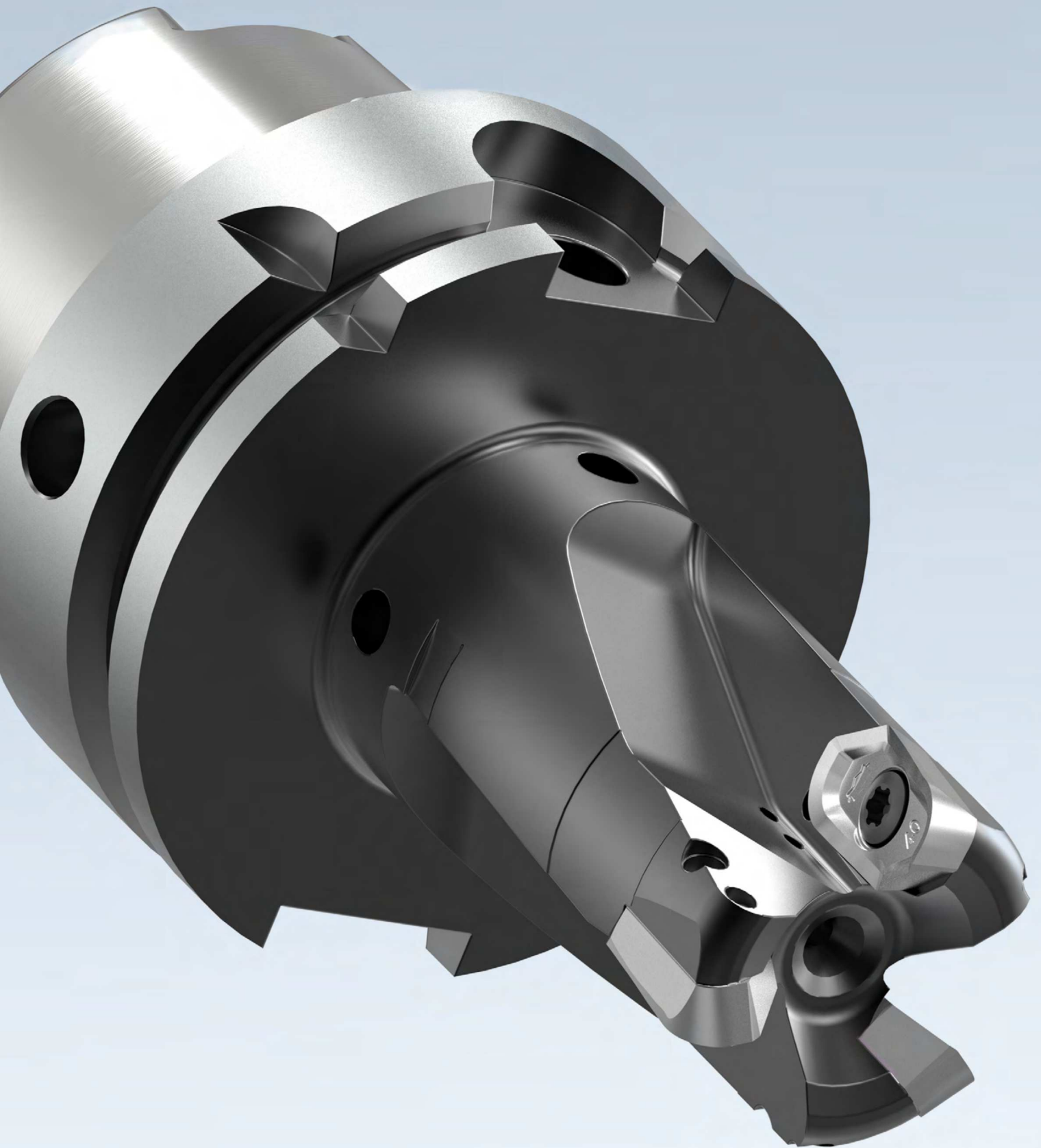

# NeoMill®-Alu-QBig

Shoulder milling cutter, with radial technology  
XDHT15

## Design:

Diameter of milling cutter: 32.00 - 50.00 mm

## Application:

High-volume machining of parts from aluminum wrought alloys for pre-machining and fine machining.

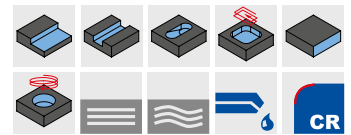
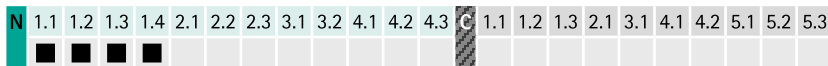
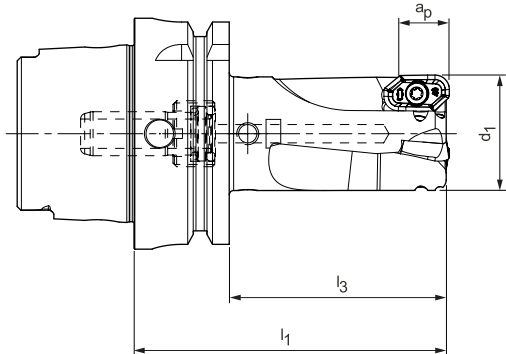

### Preferred series available from stock | With HSK-A63 connection

Dimensions				$Z_{eff}$	$a_p$ max.	Plunge angle [°]	Weight [kg]	max. operating speed [rpm]	Internal cooling	Specification	Order no.
$d_1$	HSK-A nominal size	$l_1$	$l_3$								
32	63	86	58	3	13,0	10,3	0,9	43.500	✓	ICM901-032-086-A063-Z3R-XD15	31458258
32	63	105	77	3	13,0	10,3	1,0	43.500	✓	ICM901-032-105-A063-Z3R-XD15	31458259
40	63	110	81	4	13,0	7,6	1,3	39.000	✓	ICM901-040-110-A063-Z4R-XD15	31458281
50	63	110	81	3	13,0	5,7	1,7	35.000	✓	ICM901-050-110-A063-Z3R-XD15	31458282
50	63	110	81	4	13,0	5,7	1,7	35.000	✓	ICM901-050-110-A063-Z4R-XD15	31458283

### Preferred series available from stock | With HSK-A63 connection, with enlarged face connection $\varnothing$ 80 mm

Dimensions				$Z_{eff}$	$a_p$ max.	Plunge angle [°]	Weight [kg]	max. operating speed [rpm]	Internal cooling	Specification	Order no.
$d_1$	HSK-A nominal size	$l_1$	$l_3$								
50	63	110	81	4	13,0	5,7	2,1	35.000	✓	ICM901-050-110-AP63-Z4R-XD15	31458286

### Preferred series available from stock | With HSK-FM80 Makino connection

Dimensions				$Z_{eff}$	$a_p$ max.	Plunge angle [°]	Weight [kg]	max. operating speed [rpm]	Internal cooling	Specification	Order no.
$d_1$	Nominal size HSK-FM	$l_1$	$l_3$								
50	80	110	81	4	13,0	5,7	2,1	35.000	✓	ICM901-050-110-FM80-Z4R-XD15	31458288

## Accessories

	XDHT15..	Indexable insert	Page 141
---	----------	------------------	----------

## Spare parts\*

	Clamping screw for indexable insert TORX PLUS® M4X7.8-TX15-IP	Order no. 31438975
---	---	-----------------------

Dimensions in mm.

For cutting data recommendations, see chapter "Technical Appendix".

\*Included in scope of delivery.

The maximum operating speeds refer only to the cutting edge system.



# NeoMill®-Alu-QBig

Shoulder milling cutter, with radial technology  
XDHT15

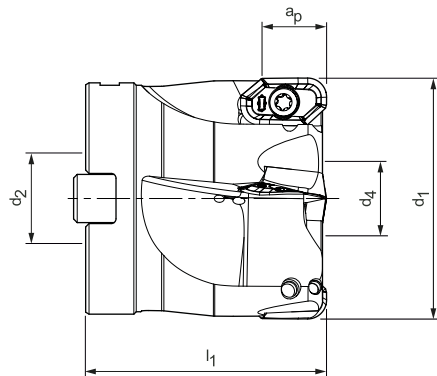

**Design:**

Diameter of milling cutter: 50.00 - 63.00 mm

**Application:**

High-volume machining of parts from aluminum wrought alloys for pre-machining and fine machining.

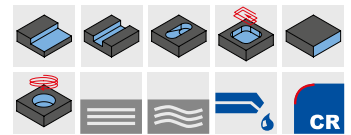
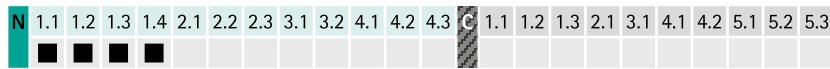

Preferred series available from stock | Milling cutter

Dimensions					Z <sub>eff</sub>	a <sub>p</sub> max.	Plunge angle [°]	Weight [kg]	max. operating speed [rpm]	Internal cooling	Specification	Order no.
d <sub>1</sub>	d <sub>2</sub>	d <sub>3</sub>	d <sub>4</sub>	l <sub>1</sub>								
50	22	48	18,5	50	3	13,0	5,7	0,5	35.000	✓	ICM901-050-CA22-Z3R-XD15	31458292
50	22	48	18,5	50	4	13,0	5,7	0,5	35.000	✓	ICM901-050-CA22-Z4R-XD15	31458293
63	27	58	20,5	50	4	13,0	4,3	0,7	31.000	✓	ICM901-063-CA27-Z4R-XD15	31458294

**Accessories**

	XDHT15..	Indexable insert	Page 141
		Milling cutter arbor for milling cutter	Page 215

**Spare parts\***

	Clamping screw for indexable insert TORX PLUS® M4X7.8-TX15-IP	Order no. 31438975
	Milling cutter clamping screw for milling cutter	Page 161

Dimensions in mm.  
For cutting data recommendations, see chapter "Technical Appendix".

\*Included in scope of delivery.  
The maximum operating speeds refer only to the cutting edge system.

# NeoMill®-Alu-QBig

Shoulder milling cutter, with radial technology  
XDHT15

**Design:**

Diameter of milling cutter: 32.00 - 63.00 mm

**Application:**

High-volume machining of parts from aluminum wrought alloys for pre-machining and fine machining.

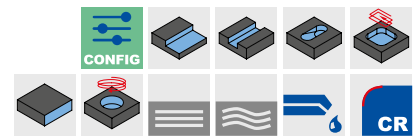
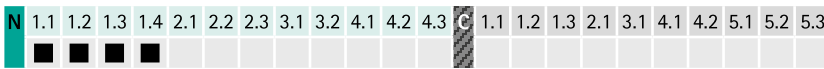
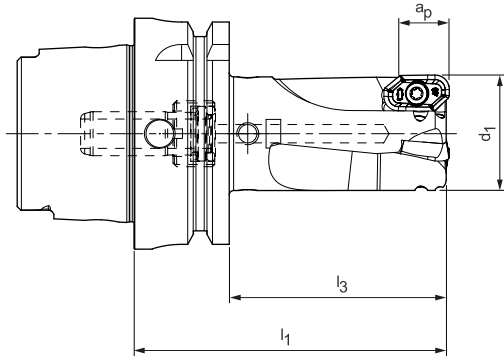

**Dimensions configurable series | With HSK-A63 connection**

Dimensions				z <sub>eff</sub>	a <sub>p</sub> max.	Plunge angle [°]	Weight [kg]	Max. operating speed [min <sup>-1</sup> ]	Internal cooling	Specification
d <sub>1</sub>	HSK-A nominal size	l <sub>1</sub>	l <sub>3</sub>							
32	63	155	126,5	3	13,0	10,3	1,3	43.500	✓	ICM901-032-155-A063-Z3R-XD15
63	63	110	81	3	13,0	4,3	2,3	31.000	✓	ICM901-063-110-A063-Z3R-XD15
63	63	110	81	4	13,0	4,3	2,2	31.000	✓	ICM901-063-110-A063-Z4R-XD15

**Dimensions of configurable series | With HSK-A63 connection, with enlarged face connection ø 80 mm**

Dimensions				z <sub>eff</sub>	a <sub>p</sub> max.	Plunge angle [°]	Weight [kg]	Max. operating speed [min <sup>-1</sup> ]	Internal cooling	Specification
d <sub>1</sub>	HSK-A nominal size	l <sub>1</sub>	l <sub>3</sub>							
50	63	110	81	3	13,0	5,7	2,1	35.000	✓	ICM901-050-110-AP63-Z3R-XD15

**Dimensions configurable series | With HSK-FM80 Makino connection**

Dimensions				z <sub>eff</sub>	a <sub>p</sub> max.	Plunge angle [°]	Weight [kg]	Max. operating speed [min <sup>-1</sup> ]	Internal cooling	Specification
d <sub>1</sub>	Nominal size HSK-FM	l <sub>1</sub>	l <sub>3</sub>							
50	80	110	81	3	13,0	5,7	2,1	35.000	✓	ICM901-050-110-FM80-Z3R-XD15

**Configurable features**

**Diameter:**  
32.00 mm - 80.00 mm

**Length:** 3.5xD

**Connection:**  
Hollow shank taper, HSK60/80, HSK63/80FM, SK

**Example:**

ICM901-063-110-A063-Z3R-XD15

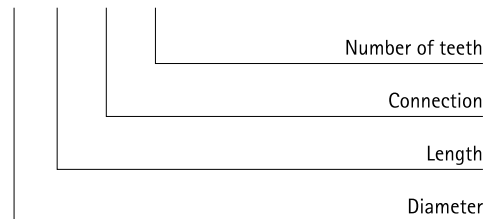

Dimensions in mm.

For cutting data recommendations, see chapter "Technical Appendix".

The maximum operating speeds refer only to the cutting edge system.

With configurable tools with useful length > 2xD, the possible material removal rate is reduced.

# NeoMill®-Alu-QBig

Shoulder milling cutter, with radial technology  
XDHT15

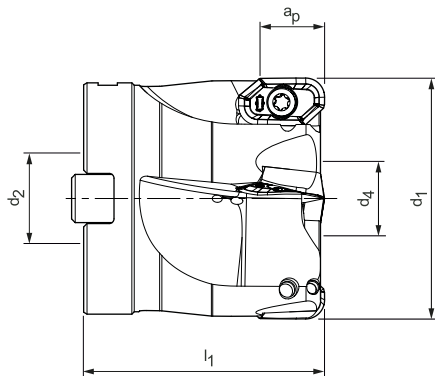

**Design:**

Diameter of milling cutter: 40.00 - 80.00 mm

**Application:**

High-volume machining of parts from aluminium wrought alloys for pre-machining and fine machining.

N	1.1	1.2	1.3	1.4	2.1	2.2	2.3	3.1	3.2	4.1	4.2	4.3	C	1.1	1.2	1.3	2.1	3.1	4.1	4.2	5.1	5.2	5.3
---	-----	-----	-----	-----	-----	-----	-----	-----	-----	-----	-----	-----	---	-----	-----	-----	-----	-----	-----	-----	-----	-----	-----

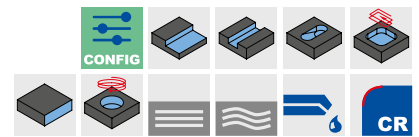

**Dimensions of configurable series | Milling cutter**

Dimensions					Z <sub>eff</sub>	a <sub>p</sub> max.	Plunge angle [°]	Weight [kg]	Max. operating speed [min <sup>-1</sup> ]	Internal cooling	Specification
d <sub>1</sub>	d <sub>2</sub>	d <sub>3</sub>	d <sub>4</sub>	l <sub>1</sub>							
40	16	38	13,8	50	3	13,0	7,6	0,3	39.000	✓	ICM901-040-CA16-Z3R-XD15
80	27	58	20,5	50	5	13,0	3,3	1,0	27.500	✓	ICM901-080-CA27-Z5R-XD15

**Note:**

The clamping screw without internal cooling included in the standard scope of delivery should preferably be used in combination with a milling cutter arbor with decentralised coolant delivery, as there is usually too little coolant reaching the blade when supplying the coolant through a clamping screw with coolant bore, particularly in case of aluminium machining.

**Configurable features**



**Diameter:**  
32.00 mm - 80.00 mm



---



**Length:**  
Length up to l<sub>1</sub> 50.00 mm





**Example:**

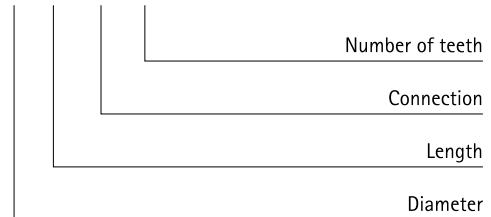

ICM901-040-50-CA16-Z3R-XD15



**Accessories**

	XDHT15..	Indexable insert	Page 141
		Milling cutter arbor for milling cutter	Page 215

**Spare parts\***

	Clamping screw for indexable insert TORX PLUS® M4X7.8-TX15-IP	Order no. 31438975
	Milling cutter clamping screw for milling cutter	Page 161

Dimensions in mm.  
For cutting data recommendations, see chapter "Technical Appendix".

\*Included in scope of delivery.  
The maximum operating speeds refer only to the cutting edge system.

# Cutting materials overview: Selecting the right cutting material

Workpiece material	<b>N</b> Aluminium			
Material type	Wrought alloy	Wrought alloy/ Cast alloys	Wrought alloy	Wrought alloy/ Cast alloys
MAPAL Machining groups	N1.1	N1.1 - N1.4	N1.1	N1.2 - N1.4
Other	Standard machining	Increased cutting speed	Increased surface finish	High cutting speed/ in abrasive workpiece materials
Cutting material type	HU612	HP675	HP665	HC660

# XDHT15

Radial indexable insert, double edge



Workpiece material	<b>N</b>					
	Al alloyed Wear-resistant		Cu alloyed Ductile			
Substrate	Carbide					
Coating	CVD	PVD		-		
Cutting material type	HC660-P	HP665-P	HP675-P	HU612		
Cutting edge design	U11	U11	U11	U10		
<b>XDHT15</b>	<b>Feed per tooth <math>f_z</math> [mm/tooth]</b>	<b><math>a_p</math> max. [mm]</b>				
XDHT150408R-...-	0.1 - 0.3	13.0	31491092	31491087	31491082	31351393
XDHT150416R-...-			31491093	31491088	31491083	31351392
XDHT150420R-...-			31491094	31491089	31491084	31351391
XDHT150430R-...-			31491095	31491090	31491085	31351390
XDHT150440R-...-			31491096	31491091	31491086	31143055

## Linear plunge angle

Tool diameter [mm]	Ramp angle [°]
32	10,3
40	7,6
50	5,7
63	4,3
80	3,3

\*  $a_p$  max. depends on the type of milling cutter and application.  
For associated clamping screws and screwdrivers, refer to the MAPAL "MILLING" catalogue.

# NeoMill®-Titan-2-Corner

## indexable insert milling cutters with a bite

NeoMill-Titan is the umbrella term for a whole family of tools with indexable inserts for titanium machining: Arbor, shank and shoulder milling cutters belong to the standard range. Chips are effectively ejected from the shear zone through optimally adapted indexable insert geometries and chip flutes. The unequal spacing of the inserts on the tool periphery ensures very quiet running.

### 1 Indexable inserts

- XPKT indexable insert with four different corner radii and three cutting material types

### 2 Coolant outlets

- Variably designed coolant outlets allow the flow rate to be regulated for each individual cutting edge (shell end milling cutter)

### 3 Positive cutting edge geometry

- The positive cutting edge geometry ensures soft cutting behaviour, which minimises thermal load on the cutting edges

### 4 Chip flute

- Chips are effectively ejected from the shear zone through optimally adapted chip flutes

### 5 Unequal spacing

- The unequal spacing of the inserts ensures very quiet running

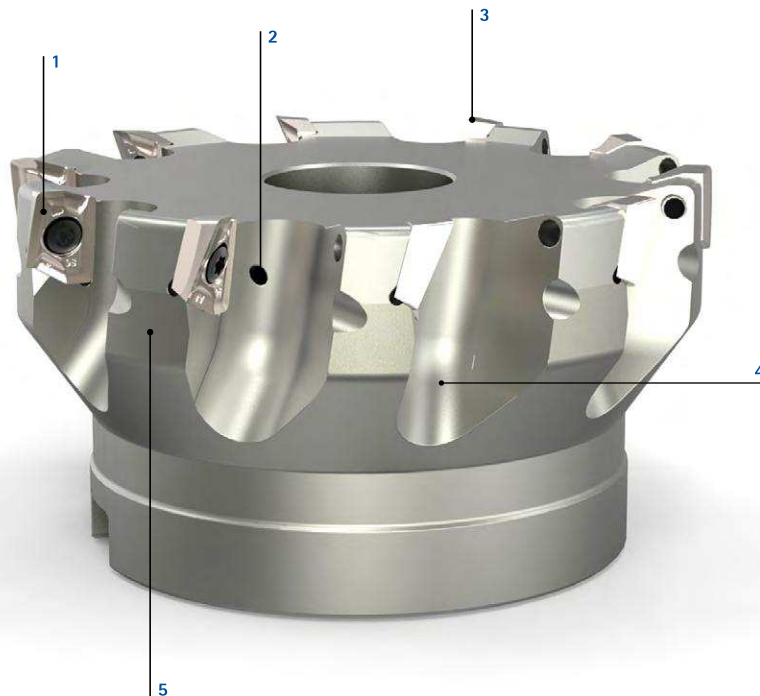

## Features

### Dimensions:

- Shoulder milling cutter as milling cutter
- Ø area: 40 mm up to 100 mm
- Standard corner radii of the indexable inserts: 0.8 / 2 / 3 and 4 mm
- Double-edge indexable insert
- ap max 10 mm
- Longer tool life
- Perfect solution for roughing and medium machining

## Tool life (min) \*

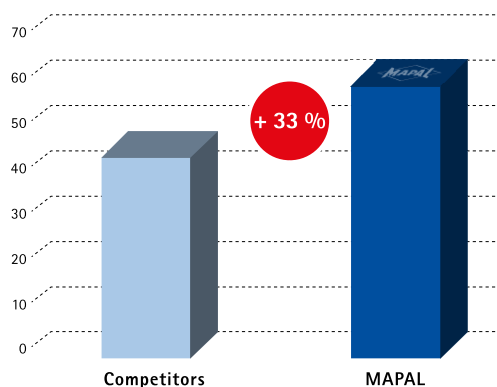

### TC6/TA15

Tool with six cutting edges

Nominal Ø: 50 mm

$v_c$ : 47 m/min

$f_z$ : 0.14 mm

$a_p$ : 3 mm

$a_e$ : 30 mm

\* Tool life per milling unit (without changing the indexable inserts or use of additional cutting edges).

# NeoMill®-Titan-2-Corner

Shoulder milling cutter, with radial technology  
XPKT11

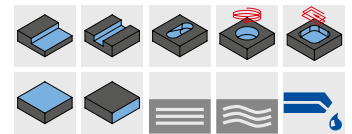
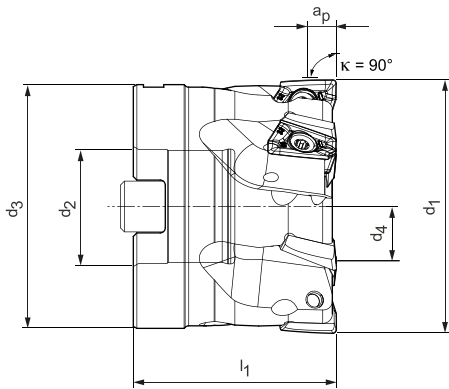



## Preferred series available from stock | Milling cutter, medium spacing

Dimensions					Z <sub>eff</sub>	a <sub>p</sub> max. *	Weight [kg]	max. operat- ing speed [rpm]	Internal cooling	Specification	Order no.
d <sub>1</sub>	d <sub>2</sub>	d <sub>3</sub>	d <sub>4</sub>	l <sub>1</sub>							
40	16	38	13,8	40	4	10	0,2	21.000	✓	ICM901-040-CA16-Z04R-XP_T11	31281086
50	22	48	18,5	40	4	10	0,3	20.000	✓	ICM901-050-CA22-Z04R-XP_T11	31281088
63	27	58	20,5	50	5	10	0,7	18.000	✓	ICM901-063-CA27-Z05R-XP_T11	31281110
80	32	78	27	55	7	10	1,5	16.000	✓	ICM901-080-CA32-Z07R-XP_T11	31281112
100	32	78	27	55	9	10	2,0	14.000	✓	ICM901-100-CA32-Z09R-XP_T11	31281114



## Preferred series available from stock | Milling cutter, close spacing

Dimensions					Z <sub>eff</sub>	a <sub>p</sub> max. *	Weight [kg]	max. operat- ing speed [rpm]	Internal cooling	Specification	Order no.
d <sub>1</sub>	d <sub>2</sub>	d <sub>3</sub>	d <sub>4</sub>	l <sub>1</sub>							
40	16	38	13,8	40	5	10	0,2	21.000	✓	ICM901-040-CA16-Z05R-XP_T11	31281087
50	22	48	18,5	40	6	10	0,3	20.000	✓	ICM901-050-CA22-Z06R-XP_T11	31281089
63	27	58	20,5	50	7	10	0,7	18.000	✓	ICM901-063-CA27-Z07R-XP_T11	31281111
80	32	78	27	55	9	10	1,5	16.000	✓	ICM901-080-CA32-Z09R-XP_T11	31281113
100	32	78	27	55	11	10	2,0	14.000	✓	ICM901-100-CA32-Z11R-XP_T11	31281115

### Accessories

	XPKT1104	Indexable insert	Page 147
	MCA-...	Milling cutter arbor	Page 215

### Spare parts\*\*

	Clamping screw for indexable insert TORX PLUS M3.5X8.1-TX10-IP	Order no. 30979520
	Milling cutter clamping screws for milling cutter	Page 160

Dimensions in mm.

The maximum operating speeds refer only to the cutting edge system.

\* A cutting depth that is bigger or smaller than the corner radius of the indexable blade should be chosen for shoulder milling.

\*\* Included in the scope of delivery.

For cutting data recommendations, see chapter "Technical Appendix".

Depending on the clamping device used, different maximum operating speeds must be observed.

# NeoMill®-Titan-2-Shell

## Shell end milling cutter with individual coolant supply

The NeoMill shell end milling cutters are available as arbor and shank versions. Due to the topography of the indexable insert, the chips are optimally formed and ejected from the shear zone via the ideally customised chip flutes. Variably designed coolant outlets allow the flow rate to be regulated for each individual cutting edge.

### 1 Clamping screw for indexable insert (TORX PLUS)

### 2 Indexable inserts

- XPKT indexable insert with four different corner radii and three cutting material types

### 3 Indexable insert seat

### 4 Threaded pin with coolant outlet

- Efficient and variable cooling concept increases tool life
- Outlet diameters can be individually set and sealed
- Easy regulation of the coolant supply at each cutting edge, whereby optimal heat removal is ensured at the cutting edge

### 5 Coolant sealing screw

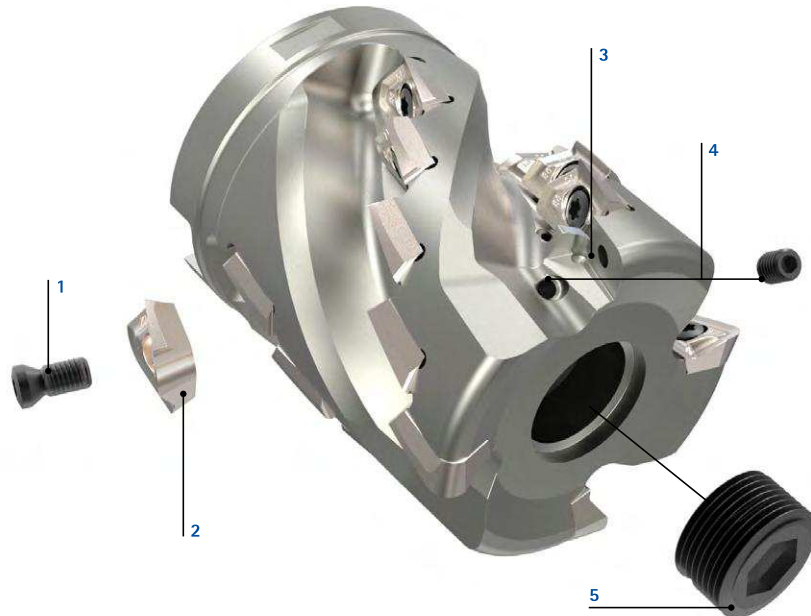

## Features

### Dimensions:

- Ø area: 32 mm up to 80 mm
- Standard corner radii of the indexable inserts: 0.8 mm / 2 mm / 3 mm and 4 mm
- Improved chip removal
- Optimal heat removal in the cutting zone
- Longer tool life
- Perfect solution for roughing and medium machining

## Tool life [min]

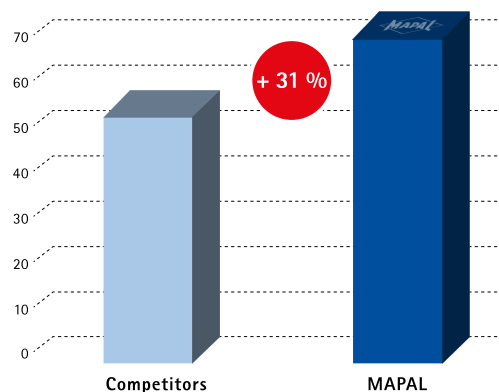

### TC6/TA15

Tool with four cutting edges

Nominal Ø: 50 mm

$v_c$ : 45 m/min

$f_z$ : 0.13 mm

$a_p$ : 24 mm

$a_e$ : 4 mm



# NeoMill®-Titan-2-Shell

Shell end milling cutter with radial technology  
XPKT11

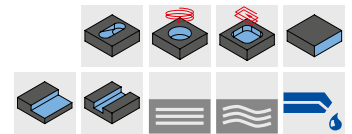
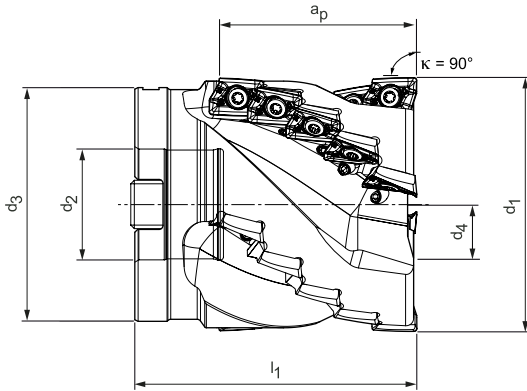

**Preferred series available from stock | Milling cutter, medium spacing**

Dimensions					Z <sub>eff</sub>	Number of indexable inserts	a <sub>p</sub> max. *	Weight [kg]	max. operating speed [rpm]	Internal cooling	Specification	Order no.
d <sub>1</sub>	d <sub>2</sub>	d <sub>3</sub>	d <sub>4</sub>	l <sub>1</sub>								
50	22	48	16,5	65	4	20	47,5	0,6	20.000	✓	ISM901-050-CA22-Z04R-XP_T11	31281119
63	27	58	20,5	70	4	20	47,5	1,0	18.000	✓	ISM901-063-CA27-Z04R-XP_T11	31281121
80	32	78	25	85	5	30	57	2,2	16.000	✓	ISM901-080-CA32-Z05R-XP_T11	31281123

**Preferred series available from stock | Milling cutter, close spacing**

Dimensions					Z <sub>eff</sub>	Number of indexable inserts	a <sub>p</sub> max. *	Weight [kg]	max. operating speed [rpm]	Internal cooling	Specification	Order no.
d <sub>1</sub>	d <sub>2</sub>	d <sub>3</sub>	d <sub>4</sub>	l <sub>1</sub>								
40	16	38	14,5	60	3	12	38	0,3	21.000	✓	ISM901-040-CA16-Z03R-XP_T11	31281118
50	22	48	16,5	65	5	25	47,5	0,5	20.000	✓	ISM901-050-CA22-Z05R-XP_T11	31281120
63	27	58	20,5	70	5	25	47,5	1,1	18.000	✓	ISM901-063-CA27-Z05R-XP_T11	31281122
80	32	78	25	85	6	36	57	2,3	16.000	✓	ISM901-080-CA32-Z06R-XP_T11	31281124

**Accessories**

	XPKT1104	Indexable insert	Page 147
	MCA-...	Milling cutter arbor	Page 215
	***	Threaded pin	Order no.
		With coolant bore Internal ø = 1 mm Internal ø = 0.5 mm	31291814 31291816
		Without coolant bore	10003420

**Spare parts\*\***

	Clamping screw for indexable insert TORX PLUS M3.5X8.1-TX10-IP	Order no. 30979520
	Threaded pin with coolant bore Internal ø = 1.5 mm	Order no. 31291811
	Milling cutter clamping screws for milling cutter	Page 160
	Coolant sealing screw	Page 160

Dimensions in mm.

The maximum operating speeds refer only to the cutting edge system.

\* A cutting depth that is bigger or smaller than the corner radius of the indexable blade should be chosen for shoulder milling.

\*\* Included in the scope of delivery.

\*\*\* Additional coolant nozzle to reduce the cross section of the coolant outlet, which results in increased coolant pressure (if there is not enough coolant pressure on the machine tool).

Depending on the clamping device used, different maximum operating speeds must be observed.

# NeoMill®-Titan-2-Shell

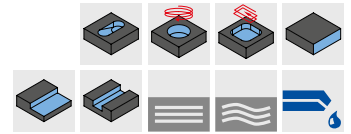
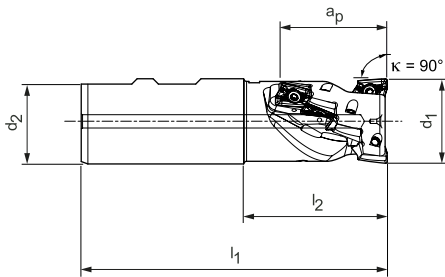

Shell end milling cutter with radial technology  
XPKT11



Preferred series available from stock | End milling cutter

Dimensions				$z_{eff}$	Number of indexable inserts	$a_p$ max. *	Weight [kg]	max. operating speed [rpm]	Shank form	Internal cooling	Specification	Order no.
$d_1$	$d_2$	$l_1$	$l_2$									
32	32	115	53	2	8	38	0,6	23.000	HB	✓	ISM901-032-115-HB32-Z2R-XP_T11	31281125
40	32	120	58	3	15	47,5	0,7	21.000	HB	✓	ISM901-040-120-HB32-Z3R-XP_T11	31281126

## Accessories

	XPKT1104	Indexable insert	Page 147
	MWC-...	For chucks refer to MAPAL "CLAMPING" catalogue	

## Spare parts\*\*

	Clamping screw for indexable insert TORX PLUS M3.5X8.1-TX10-IP	Order no. 30979520
---	--	-----------------------

Dimensions in mm.

The maximum operating speeds refer only to the cutting edge system.

\* A cutting depth that is bigger or smaller than the corner radius of the indexable blade should be chosen for shoulder milling.

\*\* Included in the scope of delivery.

For cutting data recommendations, see chapter "Technical Appendix".

Depending on the clamping device used, different maximum operating speeds must be observed.

# XPKT

Radial indexable insert, double edge



Workpiece material	<b>S</b>			
	Ni alloy ← Wear-resistant		Ti alloy → Ductile	
Substrate	Carbide			
Coating	PVD			
Cutting material type	HP990	HP993	HP995	
Cutting edge design	M33	M33	M33	
<b>XPKT11</b>	<b><math>a_p</math> max. [mm]</b>			
XPKT110408R-...-	*	31103767	31329348	31103766
XPKT110420R-...-	*	31160787	31343443	31160786
XPKT110430R-...-	*	31160789	31343444	31160788
XPKT110440R-...-	*	31160801	31343445	31160800

Dimensions [mm]				
l	d	s	d <sub>1</sub>	R
13,98	9,35	4,7	4,1	0,8
13,98	9,35	4,7	4,1	2,0
13,98	9,35	4,7	4,1	3,0
13,98	9,35	4,7	4,1	4,0

## Feed per tooth

MMG**	Cutting edge design	XPKT
		$f_z$ [mm/tooth]
<b>S</b>	<b>M33</b>	<b>0.1 - 0.25</b>

Legend: M33 = Medium machining

## Assembly note

### Tipping the shell end milling cutter NeoMill-Titan-2-Shell with XPKT indexable insert



Different indexable insert corner radii can be used in the foremost cutting edge row.  
**0.8 mm / 2.0 mm / 3.0 mm / 4.0 mm**

In the back cutting-edge rows (from the 2nd row onwards), **only** indexable inserts with a corner radius smaller than or equal to **0.8 mm** may be used.

\*  $a_p$  max. depends on the type of milling cutter and application.

\*\* MAPAL machining groups

For cutting data recommendations, see chapter "Technical Appendix".

# NeoMill®-4-HiFeed90

## Very high machining rates with good process reliability

The NeoMill-4-HiFeed90 high-feed milling cutter is a universal tool system that ensures maximum productivity and is characterised by top removal rates, extreme feed rates and big cutting depths. Offered as arbor, shank and screw-in milling cutters.

### 1 Universally applicable tool system

- Unequal spacing ensures high stability and quiet running
- Highest productivity
- Maximum rate of removal due to very high feed rates and large cutting depths

### 2 Inserts

- Four blade sizes
- Four-edge indexable insert

### 3 Slot geometry

- Effective chip transport out of the shear zone

### 4 Cutting material

- Two different cutting material types with PVD coating

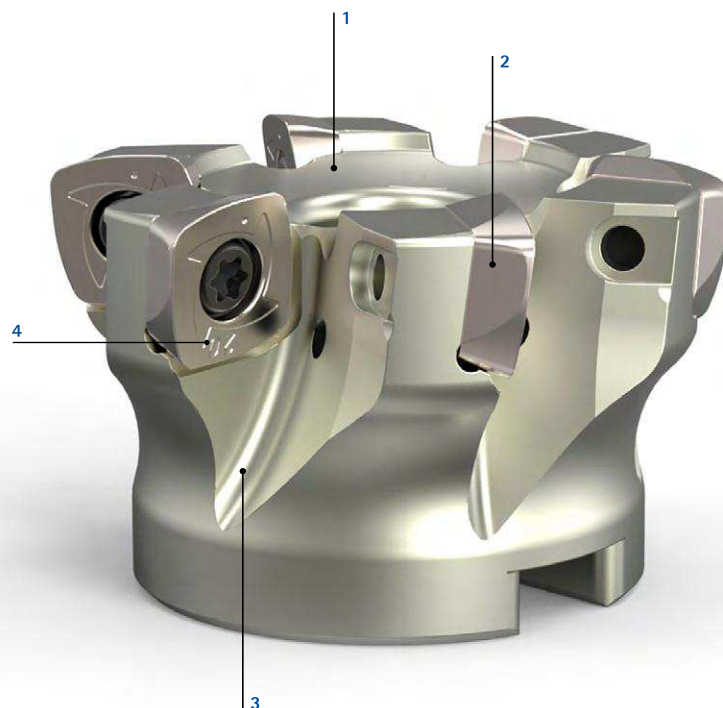

## Features

### Dimensions:

- End milling cutter, screw-in milling cutter, arbor milling cutter
- $\emptyset$  area: 16 mm up to 200 mm
- Four-edge indexable insert
- $a_p$  max 1 mm to 3.5 mm
- $z_{eff}$  two to eleven cutting edges
- SD insert size of 06, 10, 14 and 18
- Easy cutting even in full slot milling

## Tool life [min]

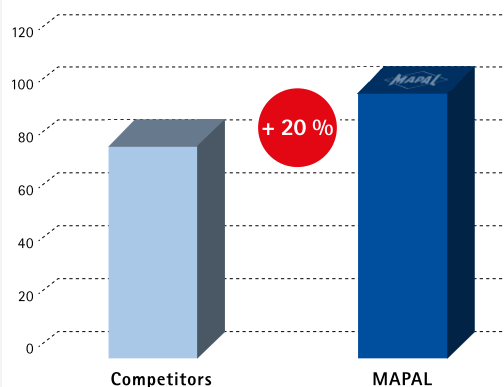

Nominal  $\emptyset$ : 50 mm  
 $v_c$ : 60 m/min  
 $f_z$ : 0.7 mm  
 $a_e$ : 31 mm

# NeoMill®-4-HiFeed90

High-feed milling cutter with radial technology  
SDMT06

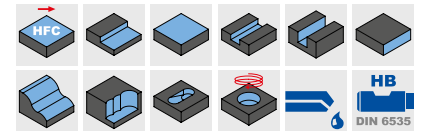
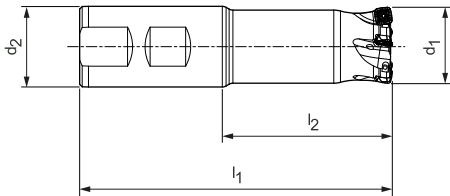

Preferred series available from stock | End milling cutter

Dimensions				Z <sub>eff</sub>	a <sub>p</sub> max.	Weight [kg]	Internal cooling	Specification	Order no.
d <sub>1</sub>	d <sub>2</sub>	l <sub>1</sub>	l <sub>2</sub>		HFC				
16	16	85	37	2	1	0,10	✓	IMH901-016-085-HB16-Z2R-SD_06	31146632
20	20	90	40	3	1	0,17	✓	IMH901-020-090-HB20-Z3R-SD_06	31146633
25	25	106	50	4	1	0,33	✓	IMH901-025-106-HB25-Z4R-SD_06	31146634
32	32	124	64	5	1	0,66	✓	IMH901-032-124-HB32-Z5R-SD_06	31146635
35	32	124	64	5	1	0,67	✓	IMH901-035-124-HB32-Z5R-SD_06	31146636

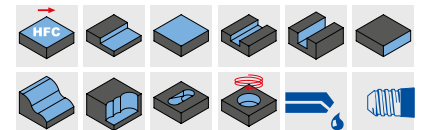
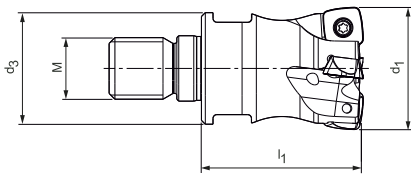

Preferred series available from stock | Screw-in milling cutter

Dimensions				Z <sub>eff</sub>	a <sub>p</sub> max.	AF	Weight [kg]	Internal cooling	Specification	Order no.
d <sub>1</sub>	M	d <sub>3</sub>	l <sub>1</sub>		HFC					
16	8	13,8	31	2	1	12	0,03	✓	IMH901-016-M008-Z02R-SD_06	31146646
20	10	18	29,8	3	1	16	0,05	✓	IMH901-020-M010-Z03R-SD_06	31146647
25	12	21	32	4	1	18	0,09	✓	IMH901-025-M012-Z04R-SD_06	31146648
32	16	29	43	5	1	24	0,21	✓	IMH901-032-M016-Z05R-SD_06	31146649
35	16	29	43	5	1	24	0,23	✓	IMH901-035-M016-Z05R-SD_06	31146650

Accessories

	SDMT0602	Indexable insert HFC	Page 154
	MWC-...	For chuck, see MAPAL "CLAMPING" catalogue	
	MFS-101	MFS milling head holder for screw-in milling cutter see MAPAL catalogue "CLAMPING"	

Spare parts\*

	SDMT0602	Clamping screw for indexable insert M2.2X5.2-TX7-IP	Order no. 31161853
--	----------	---	-----------------------

Dimensions in mm.  
For cutting data recommendations, see chapter "Technical Appendix".  
The maximum operating speeds refer only to the cutting edge system.

CAM programming note

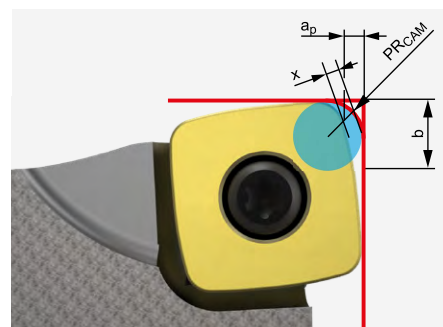

When using an HFC indexable insert, the programme radius PR<sub>CAM</sub> must be observed.

SDMT06

Dimensions [mm]			
PR <sub>CAM</sub>	a <sub>p</sub>	x	b
1,77	1,0	0,45	5,12

\*Included in scope of delivery.  
Depending on the clamping device used, different maximum operating speeds must be observed.

# NeoMill®-4-HiFeed90

High-feed milling cutter with radial technology  
SD\_\_10

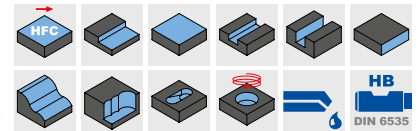
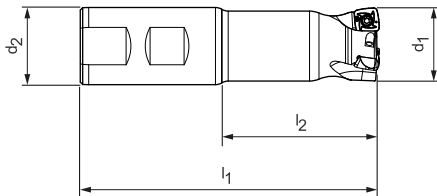

Preferred series available from stock | End milling cutter

Dimensions				Z <sub>eff</sub>	a <sub>p</sub> max.	Weight [kg]	Internal cooling	Specification	Order no.
d <sub>1</sub>	d <sub>2</sub>	l <sub>1</sub>	l <sub>2</sub>		HFC				
25	25	106	50	2	1,5	0,31	✓	IMH901-025-106-HB25-Z2R-SD__10	31144156
25	25	106	50	3	1,5	0,30	✓	IMH901-025-106-HB25-Z3R-SD__10	31144157
32	32	124	64	3	1,5	0,64	✓	IMH901-032-124-HB32-Z3R-SD__10	31144158

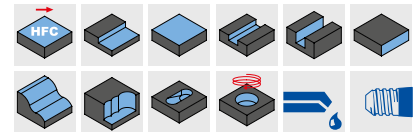
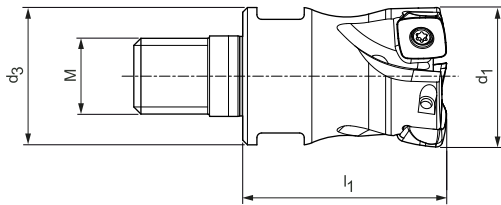

Preferred series available from stock | Screw-in milling cutter

Dimensions				Z <sub>eff</sub>	a <sub>p</sub> max.	AF	Weight [kg]	Internal cooling	Specification	Order no.
d <sub>1</sub>	M	d <sub>3</sub>	l <sub>1</sub>		HFC					
25	12	21	32	2	1,5	18	0,08	✓	IMH901-025-M012-Z02R-SD__10	31144200
25	12	21	32	3	1,5	18	0,07	✓	IMH901-025-M012-Z03R-SD__10	31144201
32	16	29	42	3	1,5	24	0,20	✓	IMH901-032-M016-Z03R-SD__10	31144206
32	16	29	43	4	1,5	24	0,17	✓	IMH901-032-M016-Z04R-SD__10	31144202
40	16	29	43	4	1,5	24	0,21	✓	IMH901-040-M016-Z04R-SD__10	31144203

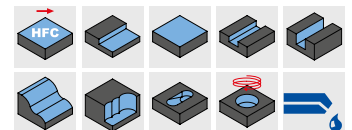
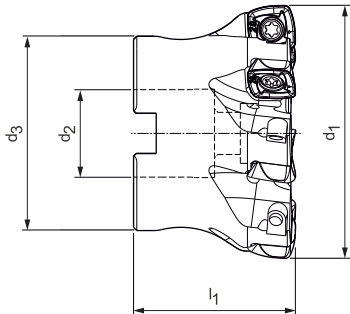

Preferred series available from stock | Milling cutter

Dimensions				Z <sub>eff</sub>	a <sub>p</sub> max.	Weight [kg]	Internal cooling	Specification	Order no.
d <sub>1</sub>	d <sub>2</sub>	d <sub>3</sub>	l <sub>1</sub>		HFC				
40	16	35	40	4	1,5	0,17	✓	IMH901-040-CA16-Z04R-SD__10	31144056
40	16	35	40	6	1,5	0,17	✓	IMH901-040-CA16-Z06R-SD__10	31144057
50	22	43	40	5	1,5	0,26	✓	IMH901-050-CA22-Z05R-SD__10	31144059
50	22	43	40	7	1,5	0,25	✓	IMH901-050-CA22-Z07R-SD__10	31144060
52	22	43	40	5	1,5	0,30	✓	IMH901-052-CA22-Z05R-SD__10	31144061
63	22	48	40	6	1,5	0,42	✓	IMH901-063-CA22-Z06R-SD__10	31144062
63	22	48	40	8	1,5	0,42	✓	IMH901-063-CA22-Z08R-SD__10	31144063
66	22	48	40	5	1,5	0,46	✓	IMH901-066-CA22-Z05R-SD__10	31144085
80	27	60	50	8	1,5	0,91	✓	IMH901-080-CA27-Z08R-SD__10	31144064

Accessories

	SD__1004	Indexable insert HFC	Page 154
		Milling cutter clamping screws for milling cutter	Page 160
	MCA-...	Milling cutter arbor	Page 215
	MWC-...	For chuck, see MAPAL "CLAMPING" catalogue	
	MFS-101	MFS milling head holder for screw-in milling cutter see MAPAL catalogue "CLAMPING"	

CAM programming note

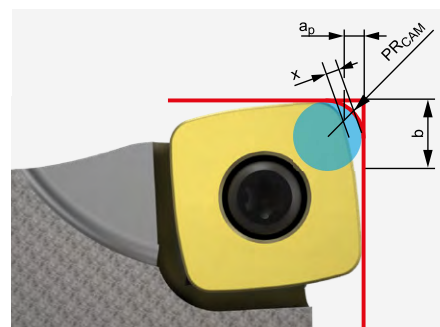

When using an HFC indexable insert, the programme radius PR<sub>CAM</sub> must be observed.

SD\_\_10

Dimensions [mm]			
PR <sub>CAM</sub>	a <sub>p</sub>	x	b
2,25	1,5	0,62	8,033

Spare parts\*

	SD__1004	Clamping screw for indexable insert M3X8.3-TX9-IP	Order no. 31161852
--	----------	---	-----------------------

Dimensions in mm.  
For cutting data recommendations, see chapter "Technical Appendix".  
The maximum operating speeds refer only to the cutting edge system.

\*Included in scope of delivery.  
Depending on the clamping device used, different maximum operating speeds must be observed.

# NeoMill®-4-HiFeed90

High-feed milling cutter with radial technology  
SDMT14

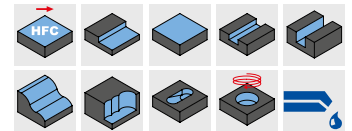
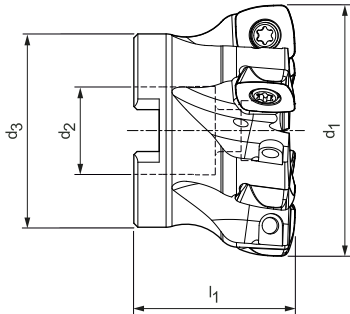

Preferred series available from stock | Milling cutter

Dimensions				Z <sub>eff</sub>	a <sub>p</sub> max.	Weight [kg]	Internal cooling	Specification	Order no.
d <sub>1</sub>	d <sub>2</sub>	d <sub>3</sub>	l <sub>1</sub>		HFC				
50	22	43	40	5	2,4	0,22	✓	IMH901-050-CA22-Z05R-SD_14	31144065
52	22	43	40	5	2,4	0,28	✓	IMH901-052-CA22-Z05R-SD_14	31144067
63	22	48	40	6	2,4	0,38	✓	IMH901-063-CA22-Z06R-SD_14	31144068
66	22	48	40	6	2,5	0,43	✓	IMH901-066-CA22-Z06R-SD_14	31144069
80	27	60	50	7	2,4	0,85	✓	IMH901-080-CA27-Z07R-SD_14	31144070
100	32	78	50	7	2,4	1,49	✓	IMH901-100-CA32-Z07R-SD_14	31144071
100	32	78	50	9	2,4	1,49	✓	IMH901-100-CA32-Z09R-SD_14	31144072
125	40	90	60	11	2,4	2,79	✓	IMH901-125-CA40-Z11R-SD_14	31144073

### Accessories

	SDMT1405	Indexable insert HFC	Page 154
	MCA-...	Milling cutter arbor	Page 215
		Milling cutter clamping screws for milling cutter	Page 160

### Spare parts\*

	SDMT1405	Clamping screw for indexable insert M5X10.8-TX20-IP	Order no. 31161851
--	----------	---	-----------------------

### CAM programming note

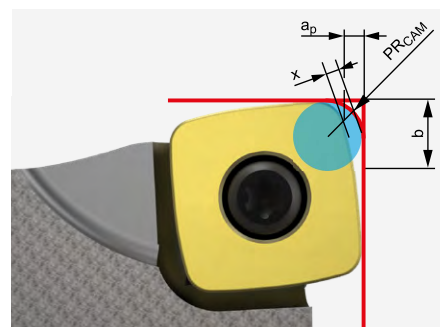

When using an HFC indexable insert, the programme radius PR<sub>CAM</sub> must be observed.

### SDMT14

Dimensions [mm]			
PR <sub>CAM</sub>	a <sub>p</sub>	x	b
3,45	2,4	0,93	10,868

Dimensions in mm.

For cutting data recommendations, see chapter "Technical Appendix". The maximum operating speeds refer only to the cutting edge system.

\*Included in scope of delivery.

Depending on the clamping device used, different maximum operating speeds must be observed.



# NeoMill®-4-HiFeed90

High-feed milling cutter with radial technology  
SDMT18

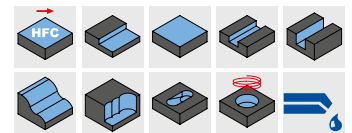
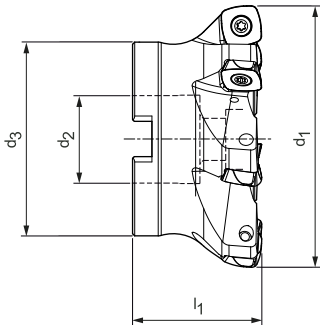

Preferred series available from stock | Milling cutter

Dimensions				Z <sub>eff</sub>	a <sub>p</sub> max.	Weight [kg]	Internal cooling	Specification	Order no.
d <sub>1</sub>	d <sub>2</sub>	d <sub>3</sub>	l <sub>1</sub>		HFC				
80	27	60	50	5	3,5	0,79	✓	IMH901-080-CA27-Z05R-SD_18	31144075
100	32	78	50	6	3,5	1,49	✓	IMH901-100-CA32-Z06R-SD_18	31144087
125	40	90	60	7	3,5	2,43	✓	IMH901-125-CA40-Z07R-SD_18	31144088
160	40	115	60	9	3,5	4,09	-	IMH900-160-CA40-Z09R-SD_18	31144089
200	60	140	65	11	3,5	5,83	-	IMH900-200-CA60-Z11R-SD_18	31144090

## Accessories

	SDMT1806	Indexable insert HFC	Page 154
	MCA-...	Milling cutter arbor	Page 215
		Milling cutter clamping screws for milling cutter	Page 160

## Spare parts\*

	SDMT1806	Clamping screw for indexable insert M6X15-T25	Order no. 31161862
--	----------	---	-----------------------

## CAM programming note

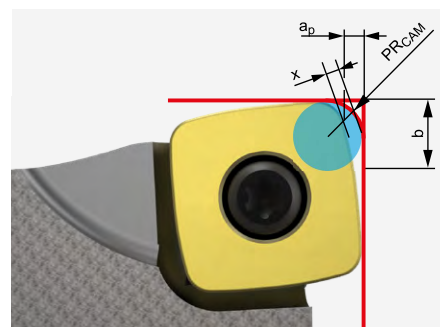

When using an HFC indexable insert, the programme radius PR<sub>CAM</sub> must be observed.

## SDMT18

Dimensions [mm]			
PR <sub>CAM</sub>	a <sub>p</sub>	x	b
4,82	3,5	1,24	13,77

Dimensions in mm.  
For cutting data recommendations, see chapter "Technical Appendix".  
The maximum operating speeds refer only to the cutting edge system.

\*Included in scope of delivery.  
Depending on the clamping device used, different maximum operating speeds must be observed.

# SDGT | SDMT

Radial indexable insert, four cutting edges



Workpiece material	<b>S</b>	
	Ni alloy ← Wear-resistant	Ti alloy → Ductile
Substrate	Carbide	
Coating	PVD	
Cutting material type	HP990	HP995

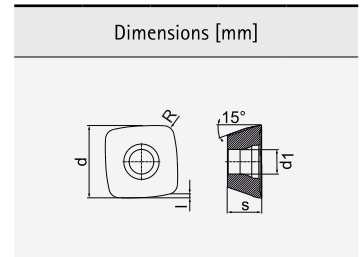

Cutting edge design	SMH	ML	SMH	ML	SMS
SD_	a <sub>p</sub> max. [mm]				
SDMT060212R-...-	*	31311724	31311727	31311725	31311729
SDMT100415R-...-	*	31311731	31311733	31311732	31311734
SDGT100415R-...-	*				31311736
SDMT140520R-...-	*	31311737	31311741	31311739	31311742
SDMT180630R-...-	*	31311745	31311748	31311746	31311749

l	d	s	d <sub>1</sub>	R
1	6,75	2,5	2,5	1,2
1,1	10,2	4,86	3,5	1,5
1,1	10,2	4,86	3,5	1,5
2,2	14,7	5	5,5	2
3	18,7	6	6,5	3

## Feed per tooth (selection according to cutting edge design) and plunge angle

MMG*	Cutting edge design	SD_06			SD_10			SD_14			SD_18														
		a <sub>p</sub> max. [mm]			f <sub>z</sub> [mm/tooth]			a <sub>p</sub> max. [mm]			f <sub>z</sub> [mm/tooth]														
S	ML	0.3	0.5	1	0.3	0.5	1	0.5	0.8	1.3	0.5	0.9	1.4	0.6	1.2	2.2	0.8	1.2	2.2	1	2	3	1	1.6	2.5
	SMH	0.3	0.5	1	0.3	0.5	0.9	0.5	0.7	1.2	0.5	0.7	1.2	0.6	1.2	2	0.6	1.2	2.2	1	2	3	1	1.5	2.5
	SMS	-	-	-	-	-	-	0.5	0.7	1.2	0.5	0.7	1.2	-	-	-	-	-	-	-	-	-	-	-	-

Legend: ML = General machining | SMH = Unstable machining | SMS = Precise machining

\* a<sub>p</sub> max. depends on the type of milling cutter and application.

\*\* MAPAL machining groups

For associated clamping screws and screwdrivers, refer to the MAPAL "MILLING" catalogue.  
For cutting data recommendations, see chapter "Technical Appendix".

# TGMill-4-Shell

Shell end milling cutter with tangential technology  
CT\_Q09

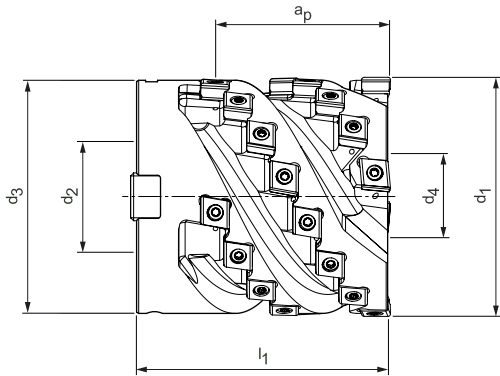



Preferred series available from stock | Milling cutter, medium spacing

Dimensions					z <sub>eff</sub>	Number Indexable insert	a <sub>p</sub> max.	Weight [kg]	max. operating speed [rpm]	Internal cooling	Specification	Order no.
d <sub>1</sub>	d <sub>2</sub>	d <sub>3</sub>	d <sub>4</sub>	l <sub>1</sub>								
63	27	58	20,5	75	3	21	50	1,2	25.800	✓	ISM901-063-CA27-Z3R-CT_Q09	31437723
80	32	78	25	85	4	32	60	2,5	23.000	✓	ISM901-080-CA32-Z4R-CT_Q09	31437724
100	32	78	25	95	5	45	65	4,4	20.400	✓	ISM901-100-CA32-Z5R-CT_Q09	31437725

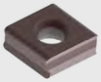

Preferred series available from stock | Milling cutter, close spacing

Dimensions					z <sub>eff</sub>	Number Indexable insert	a <sub>p</sub> max.	Weight [kg]	max. operating speed [rpm]	Internal cooling	Specification	Order no.
d <sub>1</sub>	d <sub>2</sub>	d <sub>3</sub>	d <sub>4</sub>	l <sub>1</sub>								
63	27	58	20,5	75	4	28	50	1,3	25.800	✓	ISM901-063-CA27-Z4R-CT_Q09	31403971
80	32	78	25	85	5	40	60	2,6	23.000	✓	ISM901-080-CA32-Z5R-CT_Q09	31403972
100	32	78	25	95	6	54	65	4,5	20.400	✓	ISM901-100-CA32-Z6R-CT_Q09	31403973

## Accessories

	CT_Q0905	Indexable inserts	Page 158
		Milling cutter arbor for milling cutter see MAPAL catalogue "CLAMPING"	

## Spare parts\*

	CTHQ	Clamping screw for indexable insert TORX PLUS® M3.5x11-TX10-IP	Order no. 10105079
		Milling cutter clamping screw for milling cutter ø 63 mm: ø 80 mm: ø 100 mm	Order no. 10003677 10003691 10003691
		Coolant sealing screw ø 63 mm: ø 80 mm: ø 100 mm	Order no. 31248082 31248083 31248083

Dimensions in mm.  
For cutting data recommendations, see chapter "Technical Appendix".

\*Included in scope of delivery.  
Tool body for aluminium machining available upon request.  
The maximum operating speeds refer to the cutting edge system.

# CTHQ | CTNQ

Tangential indexable insert, four cutting edges



Workpiece material	P		M	
			Austenitic Wear-resistant	Ferritic Ductile
Substrate	Carbide		Carbide	
Coating	PVD	CVD	PVD	
Cutting material type	HP975	HC775	HP980	HP985

Cutting edge design		H08	H06	H06	H06
<b>CTNQ09</b>	$a_p$ max. [mm]				
CTNQ090508...R-...	*	31048496	31272737	31048497	31048498
CTNQ090512...R-...	*	31048510	31272700	31048511	31048512
<b>CTHQ09</b>					
CTHQ090508...R-...	*	31048522	31272841	31048523	31048524
CTHQ090512...R-...	*	31048526	31272850	31048527	31048528

Cutting edge design		A38	A36	A36	A36
<b>CTNQ09</b>	$a_p$ max. [mm]				
CTNQ090508...R-...	*	31048514	31272812	31048515	31048516
CTNQ090512...R-...	*	31048518	31272720	31048519	31048520
<b>CTHQ09</b>					
CTHQ090508...R-...	*	31048530	31272837	31048531	31048532
CTHQ090508...R90M008-...	*		31272835	31190733	
CTHQ090512...R-...	*	31048534	31272845	31048535	31048536

## Feed per tooth

Application		Roughing				Medium machining					
		H06		H08		H21	A36		A38		H20
Cutting edge design		PVD	CVD	PVD	CVD	PVD	PVD	CVD	PVD	CVD	PVD
Coating											
Edge rounding		++		+++		+	++		+++		0
Feed/tooth [mm]	P	0,12-0,3	0,12-0,23	0,12-0,35	0,12-0,27		0,1-0,25	0,1-0,19	0,12-0,25	0,12-0,19	
	M	0,1-0,3	0,1-0,23				0,12-0,25	0,12-0,19			
	K			0,12-0,4	0,12-0,3				0,1-0,3	0,1-0,23	
	N					0,15 - 0,35					0,1 - 0,3

Legend: 0 = sharp edged | + = slightly rounded | ++ = medium rounded | +++ = heavily rounded

\*  $a_p$  max. depends on the type of milling cutter and application.

For associated clamping screws and screwdrivers, refer to the MAPAL "MILLING" catalogue.

For cutting data recommendations, see chapter "Technical Appendix".

K				N	
GJL Wear-resistant		GJS Ductile		GJL Wear-resistant	
GJS Ductile		GJS Ductile			
Carbide				Carbide	
PVD		CVD		-	PVD
HP965	HP975	HC760	HC770	HU616	HP616
H08	H08	H08	H08		H21
31048495	31048496	31272745	31272748		
31048499	31048510	31272705	31272707		
31048521	31048522	31272843	31272844		31414891
31048525	31048526	31272851	31272855		31414877
A38	A38	A38	A38	H20	
31048513	31048514	31272816	31272817		
31048517	31048518	31272725	31272726		
31048529	31048530	31272838	31272840	31316862	
				31316865	
31048533	31048534	31272847	31272848	31316863	

# SPGN

Radial indexable inserts, four cutting edges



Workpiece material	<b>K</b>
Substrate	Carbide
Coating	PVD
Cutting material type	HP968

Cutting edge design			
SPGN09	$a_p$ max. [mm]		
SPGN090308E02N-0A-	*		31300873
<b>SPGN12</b>			
SPGN120408E02N-0A-	*		31158916
SPGN120412E02N-0A-	*		31211969
SPGN120420E02N-0A-	*		31300875
SPGN120430E02N-0A-	*		31300876
<b>SPGN15</b>			
SPGN150408E02N-0A-	*		31158930
SPGN150416E02N-0A-	*		31300879
SPGN150430E02N-0A-	*		31158933
SPGN150440E02N-0A-	*		31300901
SPGN150450E02N-0A-	*		31300902
<b>SPGN19</b>			
SPGN190408E02N-0A-	*		31211991
SPGN190412E02N-0A-	*		31158936
SPGN190430E02N-0A-	*		31204113
SPGN190440E02N-0A-	*		31300903
SPGN190450E02N-0A-	*		31211993

\*  $a_p$  max. depends on the type of milling cutter and application.

For associated clamping screws and screwdrivers, refer to the MAPAL "MILLING" catalogue.

For cutting data recommendations, see chapter "Technical Appendix".

## CUSTOM-MADE DISC MILLING CUTTER



Combination disc milling cutter and insert drill for machining wheel carriers or swivel bearings with low non-productive times and reduced number of tools.

► Customised special design available on request

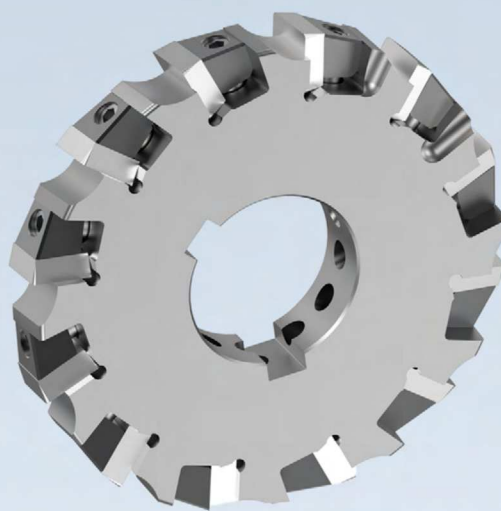

# Accessories for milling cutters with indexable inserts



## Milling cutter clamping screws and coolant sealing screw

Series	Diameter of milling cutter	Diameter of milling cutter arbor	Milling cutter clamping screw		Coolant sealing screw	
			Without internal cooling*	With internal cooling		
						
<b>NeoMill-Titan-2-Corner</b> 	XPKT11	40	16	10003638	31006779	-
		50	22	10003660	31006800	-
		63	27	10003677	31008546	-
		80	32	10003691	31008547	-
		100	32	10003691	31008547	-
<b>NeoMill-Titan-2-Shell</b> 	XPKT11	40	16	10003638	31006779	31143577
		50	22	10003660	31006800	10033245
		63	27	10003677	31008546	31248082
		80	32	10003691	31008547	31248083
<b>NeoMill-4-Hi-Feed90</b> 	SD__10	40	16	31166231	-	-
		50 - 66	22	10003659	-	-
		80	27	10003677	31008546	-
	SD__14	50 - 52	22	31166232	-	-
		63 - 66	22	10003659	-	-
		80	27	10003677	31008546	-
		100	32	10003690	-	-
	SD__18	125	40	10081881	-	-
		80	27	10003677	31008546	-
		100	32	10003690	-	-
		125	40	10081881	-	-
		160	40	10006594 (x4)	-	-
200	60	10006594 (x4)	-	-		

### Note:

Milling cutter clamping screw without internal cooling is the first choice when using milling cutter arbors with decentralised coolant delivery (see Page 215) as a higher coolant flow can be achieved. Milling cutter clamping screws with internal cooling may only be used if the coolant flow between the milling cutter arbor and milling cutter can only take place over a screw.

Dimensions in mm.

\*Included in scope of delivery for the tool body.



**Milling cutter clamping screws and coolant sealing screw**

Series		Diameter of milling cutter	Diameter of milling cutter arbor	Milling cutter clamping screw		Coolant sealing screw
				Without internal cooling*	With internal cooling	
						
<b>NeoMill-T-Finish</b>  	CTHQ   CTHD	50 / 61,5	22	10003660	–	–
		63 / 74,5	27	10003660	–	–
		80 / 91,5	27	10003677	–	–
		100 / 111,5	32	10003690	–	–
		125 / 136,5	40	10111521	–	–
		160 / 171,5	40	10006594	–	–
		200 / 211,5	60	10022995	–	–
		250 / 261,5	60	10022995	–	–
315 / 326,5	60	10022995	–	–		
<b>NeoMill-Alu-QBig</b>  	XDHT15	40	16	10003638	10003676	–
		50	22	10003660	31006800	–
		63	27	10003676	31008546	–
		80	27	10003676	31008546	–

Dimensions in mm.

\*Included in scope of delivery for the tool body.

**Note:**

Milling cutter clamping screw without internal cooling is the first choice when using milling cutter arbors with decentralised coolant delivery (see Page 215) as a higher coolant flow can be achieved. Milling cutter clamping screws with internal cooling may only be used if the coolant flow between the milling cutter arbor and milling cutter can only take place over a screw.

# CLAMPING

---

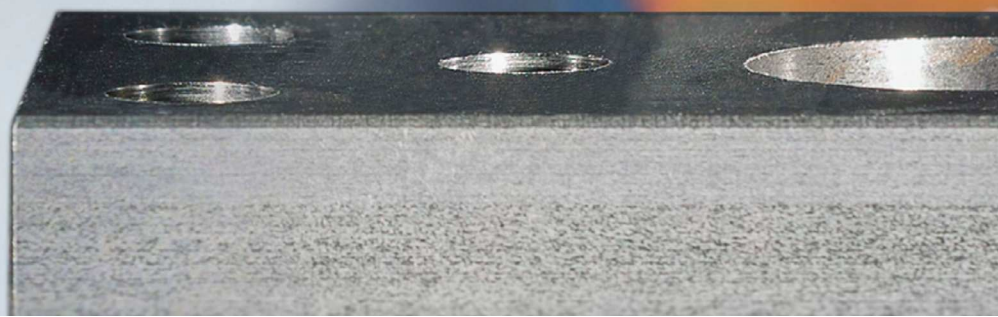

UNIQ hydraulic chuck with new connections and lengths.  
Hydraulic chuck MQL, 1-channel and 2-channel system.  
Shrink chuck MQL, 1-channel and 2-channel system.  
Hydraulic chuck with hollow shank taper-C und hollow shank taper-E connection. Milling cutter arbor with enlarged face connection, with decentralised coolant delivery.





# Selection of a chuck

The optimal chuck for every application – four steps to the right chuck

1 TECHNOLOGY		2 DESIGN			
 <p>Hydraulic clamping technology</p>	UNIQ	UNIQ Mill Chuck, HA	<input checked="" type="checkbox"/>		
		UNIQ DReaM Chuck, 4.5°	<input checked="" type="checkbox"/>		
	HighTorque Chuck HTC	Narrow design, 3°			
		Short heavy-duty design <sup>1)</sup>			
		Short heavy-duty design with cooling channel bores <sup>2)</sup>			
	HydroChuck MHC	With axial length adjustment		<input checked="" type="checkbox"/>	
		With axial length adjustment, MQL, 1-channel / 2-channel system		<input checked="" type="checkbox"/>	
		With radial length adjustment			
		Hydro DReaM Chuck, cylindrical slim			
		With compensation technology <sup>3)</sup>			
 <p>Shrinking technology</p>	ThermoChuck MTC	Narrow design, 3°			
		4.5°			
		4.5°, MQL, 1-channel / 2-channel system		<input checked="" type="checkbox"/>	
		With cooling channel bores <sup>2)</sup>			
 <p>Mechanical tool clamping technology</p>	Mechanical systems	MillChuck, HB   MWC			
		With side clamping surface   MWC			
		With angled clamping surface   MNC			
		With collet   MCC			
		Precision drill chuck   MPC			
		Softsynchro   MSC			
		Milling cutter arbor   MCA			
		Milling cutter arbor / MCA, with decentralised coolant delivery		<input checked="" type="checkbox"/>	
Milling cutter arbor, vibration-dampened   MDA					

★ = 1st choice

■ = highly suitable





▣ = suitable in some situations

□ = not suitable

1) Short/heavy-duty design: Compact design for high rigidity.

2) With cooling channel bores: Chuck with additional decentral coolant outlets that, optionally, are resealable.

3) With compensation technology: Alignment feature on the chuck for radial alignment to compensate for radial run-out errors on the overall system.

	3 APPLICATION					4 PAGE	
	MILLING			DRILLING	REAMING	MAIN CATALOGUE	SUPPLEMENTARY VOLUME
	HPC	Roughing	Finishing				
							
	■	★	★	■	■		168
	▣	▣	■	★	★		172
	□	□	▣	■	■	✓	
	■	■	■	■	■	✓	
	■	■	■	■	■	✓	
	□	■	■	■	■		176
	□	■	■	■	■		190/202
	□	□	■	■	■	✓	
	□	□	□	■	■	✓	
	□	□	■	▣	■	✓	
	□	□	▣	■	■	✓	
	▣	▣	■	■	■	✓	
	▣	▣	■	■	■		193/209
	▣	▣	■	■	■	✓	
	★	■	▣	▣	▣	✓	
	■	■	▣	▣	▣	✓	
	■	■	▣	▣	▣	✓	
	□	▣	▣	▣	▣	✓	
	□	□	□	■	▣	✓	
	□	□	□	□	□	✓	
	■	■	■	□	□	✓	
	■	■	■	□	□		215
	★	★	★	□	□	✓	

# INDUSTRIAL DESIGN WITH ADDED VALUE – UNIQ<sup>®</sup> CHUCK

The newly-developed hydraulic expansion clamping system enables high machining parameters through excellent stability and accuracy. It minimises self-excited vibration so that clamped tools are not exposed to micro-vibration. This in turn leads to a reduced spindle load of up to 5 per cent, enables significantly longer tool life and guarantees optimal surface quality.

In addition, the brilliant surface which MAPAL creates using a specially developed polishing process ensures that the chucks are more resistant to dirt and corrosion. Users can safely clamp the tool in the holder with little force. This is ensured by "foolproof handling", i.e. simple and self-explanatory handling of the chucks. A lot of time is saved compared to other clamping mechanisms, especially with the UNIQ Hydro DReaM Chuck 4.5°.



## Design features in detail:



**Use of form**

FEM-supported contours for maximum rigidity with minimum use of resources

**Polished surface**

Maximum corrosion and dirt resistance

**Blue actuator screw**

- Optical control element – foolproof  
- Reduced risk of errors and accidents

**Reduced tightening torque**

- Reduced non-productive times  
- Ergonomic handling

**Signature elements**

Information regarding function and product



**Use of form | Bionic contours**

- Higher stability and accuracy of the overall system
- Less displacement of the tool
- The tool cutting edge is constantly engaged
- Less weight through minimal use of resources
- Sits well in the hand when setting up the tool magazine
- Self-excited vibrations are minimised
- The tools are not exposed to micro-vibrations

**Polished surfaces**

- Dirt resistance (corrosion resistance) increased
- Highest balancing qualities due to compacted surfaces

**Blue actuator screw | Signature elements**

- Clear assignment of the operating screw and easier actuation through reduction of the tightening torque of the actuator screw by up to 70%
- Clear arrangement on the product, important functional and product information immediately available

# UNIQ<sup>®</sup> Mill Chuck, HA

With axial tool length adjustment

HSK-A (hollow shank taper form A) shank according to DIN 69893-1

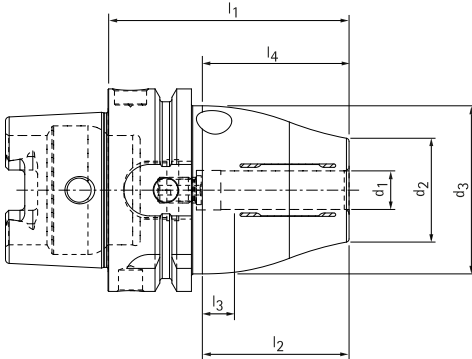

## Preferred series available from stock

HSK-A	Dimensions							G	Torque * [Nm]	Specification	Order no.
	$d_1$	$d_2$	$d_3$	$l_1$	$l_2$	$l_3$	$l_4$				
63	6,0	26,0	50,0	65,0	37,0	10,0	35,2	M5	22	MHC-HSK-A063-06-065-1-0-A	31270591
63	8,0	28,0	50,0	65,0	37,0	10,0	35,2	M6	47	MHC-HSK-A063-08-065-1-0-A	31270593
63	10,0	30,0	50,0	75,0	41,0	10,0	45,2	M8x1	85	MHC-HSK-A063-10-075-1-0-A	31270595
63	12,0	32,0	52,5	75,0	46,0	10,0	45,2	M8x1	130	MHC-HSK-A063-12-075-1-0-A	31229418
63	14,0	34,0	52,5	75,0	46,0	10,0	45,2	M8x1	240	MHC-HSK-A063-14-075-1-0-A	31374670
63	16,0	38,0	52,5	79,0	49,0	10,0	49,2	M8x1	350	MHC-HSK-A063-16-079-1-0-A	31270598
63	18,0	38,0	52,5	79,0	49,0	10,0	49,2	M8x1	430	MHC-HSK-A063-18-079-1-0-A	31374671
63	20,0	38,0	52,5	79,0	51,0	10,0	49,2	M8x1	520	MHC-HSK-A063-20-079-1-0-A	31229438
63	25,0	48,0	57,0	95,0	57,0	10,0	45,0	M10x1	700	MHC-HSK-A063-25-095-1-0-A	31396170
63	32,0	58,5	62,5	110,0	61,0	10,0	56,6	M10x1	900	MHC-HSK-A063-32-110-1-0-A	31396171
100	6,0	26,0	50,0	73,0	37,0	10,0	40,2	M5	22	MHC-HSK-A100-06-073-1-0-A	31345192
100	8,0	28,0	50,0	73,0	37,0	10,0	40,2	M6	47	MHC-HSK-A100-08-073-1-0-A	31345193
100	10,0	30,0	50,0	83,0	41,0	10,0	50,2	M8x1	85	MHC-HSK-A100-10-083-1-0-A	31345194
100	12,0	32,0	52,5	83,0	46,0	10,0	50,2	M8x1	130	MHC-HSK-A100-12-083-1-0-A	31345195
100	14,0	34,0	52,5	83,0	46,0	10,0	50,2	M8x1	240	MHC-HSK-A100-14-083-1-0-A	31345196
100	16,0	38,0	52,5	87,0	49,0	10,0	54,2	M8x1	350	MHC-HSK-A100-16-087-1-0-A	31345197
100	18,0	38,0	52,5	87,0	49,0	10,0	54,2	M8x1	430	MHC-HSK-A100-18-087-1-0-A	31345198
100	20,0	38,0	52,5	87,0	51,0	10,0	54,2	M8x1	520	MHC-HSK-A100-20-087-1-0-A	31345199
100	25,0	56,0	70,0	95,0	57,0	10,0	62,2	M10x1	700	MHC-HSK-A100-25-095-1-0-A	31345200
100	32,0	60,0	75,0	100,0	61,0	10,0	67,2	M10x1	900	MHC-HSK-A100-32-100-1-0-A	31345201

\* Permissible transferable torque.

Dimensions in mm.

Use: For clamping tools with smooth cylindrical shanks according to DIN 1835 form A, DIN 6535 form HA as well as with recesses according to DIN 1835 form B, E and DIN 6535 form HB, HE directly and with reducing sleeve in the clamping diameter. The clamping diameter is designed for a shank tolerance of h6.

Scope of delivery: With length adjustment screw, without coolant tube.

Design: Highest tool life and production quality when using smooth cylindrical shanks according to DIN 1835 form A and DIN 6535 form HA. With a projection length of 2.5xD (max. 50 mm) radial run-out accuracy 3  $\mu$ m. When using cylindrical shanks with an in-

clined clamping surface (form E and form HE), the accuracy may be impaired. Torque transmission perfectly tailored to your application.

Note: Coolant supply via central through hole. Coolant tubes, code carrier, reducing sleeve for reducing the clamping diameter (on the usage of the reducing sleeve the accuracy may be degraded) see section "Accessories, spare parts and measuring equipment". Length adjustment screws available on request.

Balancing quality: G 2.5 with 25,000 rpm in delivery status.



# UNIQ<sup>®</sup> Mill Chuck, HA

With axial tool length adjustment

SK shank according to ISO 7388-1 Form AD/AF

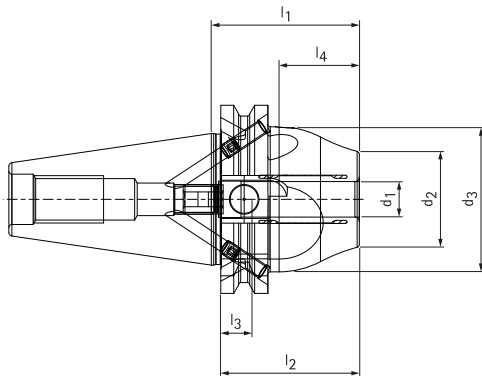

### Preferred series available from stock

Steep taper	Dimensions								G	Torque * [Nm]	Specification	Order no.
	d <sub>1</sub>	d <sub>2</sub>	d <sub>3</sub>	d <sub>4</sub>	l <sub>1</sub>	l <sub>2</sub>	l <sub>3</sub>	l <sub>4</sub>				
40	6,0	26,0	42,0	-	50,0	37,0	10,0	27,1	M5	22	MHC-SK040-06-050-3-0-A	31345212
40	8,0	28,0	42,0	-	50,0	37,0	10,0	27,1	M6	47	MHC-SK040-08-050-3-0-A	31345213
40	10,0	30,0	42,0	-	50,0	41,0	10,0	27,1	M8x1	85	MHC-SK040-10-050-3-0-A	31345214
40	12,0	32,0	49,0	-	50,0	46,0	10,0	27,1	M10x1	130	MHC-SK040-12-050-3-0-A	31345215
40	14,0	34,0	49,0	-	50,0	46,0	10,0	27,1	M10x1	240	MHC-SK040-14-050-3-0-A	31374686
40	16,0	38,0	49,0	-	64,5	49,0	10,0	41,6	M12x1	350	MHC-SK040-16-065-3-0-A	31345216
40	18,0	38,0	49,0	-	64,5	49,0	10,0	41,6	M12x1	430	MHC-SK040-18-065-3-0-A	31374687
40	20,0	38,0	49,0	-	64,5	51,0	10,0	41,6	M16x1	520	MHC-SK040-20-065-3-0-A	31345217
40	25,0	48,0	57,0	49,5	110,0	57,0	10,0	65,3	M10x1	700	MHC-SK040-25-110-3-0-A	31396178
40	32,0	58,5	62,5	49,5	115,0	61,0	10,0	65,5	M12x1	900	MHC-SK040-32-115-3-0-A	31396179

\* Permissible transferable torque.

Dimensions in mm.

Use: For clamping tools with smooth cylindrical shanks according to DIN 1835 form A, DIN 6535 form HA as well as with recesses according to DIN 1835 form B, E and DIN 6535 form HB, HE directly and with reducing sleeve in the clamping diameter. The clamping diameter is designed for a shank tolerance of h6.

Scope of delivery: With length adjustment screw, without pull stud.

Design: Highest tool life and production quality when using smooth cylindrical shanks according to DIN 1835 form A and DIN 6535 form HA. With a projection length of 2.5xD (max. 50 mm) radial run-out accuracy 3 µm. When using cylindrical shanks with an in-

clined clamping surface (form E and form HE), the accuracy may be impaired. Torque transmission perfectly tailored to your application.

Note: Coolant supply via central through hole. Pull stud, reducing sleeves to reduce the clamping diameter (if the reducing sleeve is used, the accuracy may be impaired), see section "Accessories and spare parts". Length adjustment screws available on request.

Balancing quality: G 2.5 with 25,000 rpm in delivery status.

# UNIQ<sup>®</sup> Mill Chuck, HA

With axial tool length adjustment

Shank BT according to ISO 7388-2 Form JD/JF (JIS B 6339)

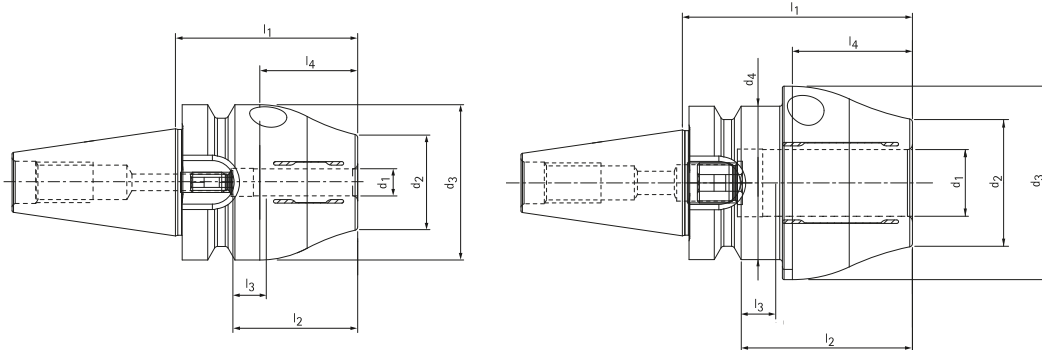

## Preferred series available from stock

BT	Dimensions								G	Torque* [Nm]	Specification	Order no.
	d <sub>1</sub>	d <sub>2</sub>	d <sub>3</sub>	d <sub>4</sub>	l <sub>1</sub>	l <sub>2</sub>	l <sub>3</sub>	l <sub>4</sub>				
30**	6,0	26,0	46,0	-	54,0	37,0	10,0	29	M5	22	MHC-BT030-06-054-1-0-A	31280342
30**	8,0	28,0	46,0	-	54,0	37,0	10,0	29	M6	47	MHC-BT030-08-054-1-0-A	31280343
30**	10,0	30,0	50,0	46,0	54,0	41,0	10,0	23,5	M8x1	85	MHC-BT030-10-054-1-0-A	31280344
30**	12,0	32,0	50,0	46,0	54,0	46,0	10,0	23,5	M10x1	130	MHC-BT030-12-054-1-0-A	31280345
30**	14,0	38,0	52,0	46,0	54,0	46,0	10,0	21,0	M10x1	240	MHC-BT030-14-054-1-0-A	31374678
30**	16,0	38,0	55,0	46,0	69,0	49,0	10,0	38,5	M12x1	350	MHC-BT030-16-069-1-0-A	31280346
30**	18,0	38,0	55,0	46,0	69,0	49,0	10,0	36,0	M12x1	430	MHC-BT030-18-069-1-0-A	31374679
30**	20,0	38,0	58,0	46,0	69,0	51,0	10,0	38,5	M12x1	520	MHC-BT030-20-069-1-0-A	31280347
40	6,0	26,0	42,0	-	58,0	37,0	10,0	27,2	M5	22	MHC-BT040-06-058-3-0-A	31345236
40	8,0	28,0	42,0	-	58,0	37,0	10,0	27,2	M6	47	MHC-BT040-08-058-3-0-A	31345237
40	10,0	30,0	42,0	-	58,0	41,0	10,0	27,2	M8x1	85	MHC-BT040-10-058-3-0-A	31345238
40	12,0	32,0	49,0	-	58,0	46,0	10,0	27,2	M10x1	130	MHC-BT040-12-058-3-0-A	31345239
40	14,0	34,0	49,0	-	58,0	46,0	10,0	27,2	M10x1	240	MHC-BT040-14-058-3-0-A	31396154
40	16,0	38,0	49,0	-	72,5	49,0	10,0	41,7	M12x1	350	MHC-BT040-16-073-3-0-A	31345240
40	18,0	38,0	49,0	-	72,5	49,0	10,0	41,7	M12x1	430	MHC-BT040-18-073-3-0-A	31396155
40	20,0	38,0	49,0	-	72,5	51,0	10,0	41,7	M16x1	520	MHC-BT040-20-073-3-0-A	31345241
40	25,0	48,0	57,0	-	100,0	57,0	10,0	44,6	M16x1	700	MHC-BT040-25-100-3-0-A	31396156
40	32,0	58,5	62,0	-	105,0	61,0	10,0	50,0	M16x1	900	MHC-BT040-32-105-3-0-A	31396157

\* Permissible transferable torque.

\*\* Design: Taper shank size is not available in the JD/JF combination design

Dimensions in mm.

Use: For clamping tools with smooth cylindrical shanks according to DIN 1835 form A, DIN 6535 form HA as well as with recesses according to DIN 1835 form B, E and DIN 6535 form HB, HE directly and with reducing sleeve in the clamping diameter. The clamping diameter is designed for a shank tolerance of h6.

Scope of delivery: With length adjustment screw, without pull stud.

Design: Highest tool life and production quality when using smooth cylindrical shanks according to DIN 1835 form A and DIN 6535 form HA. With a projection length of 2.5xD (max. 50 mm) radial run-out accuracy 3 µm. When using cylindrical shanks with an in-

clined clamping surface (form E and form HE), the accuracy may be impaired. Torque transmission perfectly tailored to your application.

Note: Coolant supply via central through hole. Pull stud, reducing sleeves to reduce the clamping diameter (if the reducing sleeve is used, the accuracy may be impaired), see section "Accessories and spare parts". Length adjustment screws available on request.

Balancing quality: G 2.5 with 25,000 rpm in delivery state.

# UNIQ® Mill Chuck, HA

With axial tool length adjustment

"CAT" shank in accordance with ASME B5.50-1994

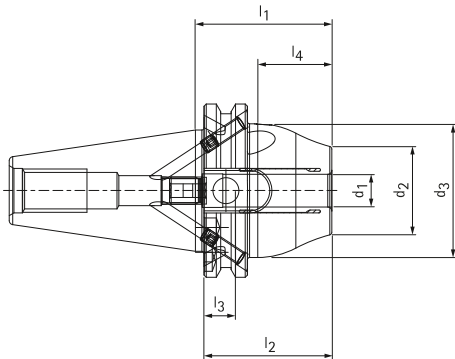

## Preferred series available from stock

CAT	Dimensions							G	Torque * [Nm]	Specification	Order no.
	$d_1$	$d_2$	$d_3$	$l_1$	$l_2$	$l_3$	$l_4$				
40	6,0	26,0	42,0	50,0	37,0	10,0	27,1	M5	22	MHC-CAT040-06-050-3-0-A	31345224
40	8,0	28,0	42,0	50,0	37,0	10,0	27,1	M6	47	MHC-CAT040-08-050-3-0-A	31345225
40	10,0	30,0	42,0	50,0	41,0	10,0	27,1	M8x1	85	MHC-CAT040-10-050-3-0-A	31345226
40	12,0	32,0	49,0	50,0	46,0	10,0	27,1	M10x1	130	MHC-CAT040-12-050-3-0-A	31345227
40	14,0	32,0	49,0	50,0	46,0	10,0	27,1	M10x1	240	MHC-CAT040-14-050-3-0-A	31374694
40	16,0	38,0	49,0	64,5	49,0	10,0	41,6	M12x1	350	MHC-CAT040-16-065-3-0-A	31345228
40	18,0	38,0	49,0	64,5	49,0	10,0	41,6	M12x1	430	MHC-CAT040-18-065-3-0-A	31374695
40	20,0	38,0	49,0	64,5	51,0	10,0	41,6	M16x1	520	MHC-CAT040-20-065-3-0-A	31345229

\* Permissible transferable torque.

Dimensions in mm.

Use: For clamping tools with smooth cylindrical shanks according to DIN 1835 form A, DIN 6535 form HA as well as with recesses according to DIN 1835 form B, E and DIN 6535 form HB, HE directly and with reducing sleeve in the clamping diameter. The clamping diameter is designed for a shank tolerance of h6.

Scope of delivery: With length adjustment screw, without pull stud.

Design: Highest tool life and production quality when using smooth cylindrical shanks according to DIN 1835 form A and DIN 6535 form HA. With a projection length of 2.5xD (max. 50 mm) radial run-out accuracy 3  $\mu$ m. When using cylindrical shanks with an in-

clined clamping surface (form E and form HE), the accuracy may be impaired. Torque transmission perfectly tailored to your application.

Note: Coolant supply via central through hole. Pull stud, reducing sleeves to reduce the clamping diameter (if the reducing sleeve is used, the accuracy may be impaired), see section "Accessories and spare parts". Length adjustment screws available on request.

Balancing quality: G 2.5 with 25,000 rpm in delivery state.

# UNIQ® DReaM Chuck, 4.5°

With axial tool length adjustment, clamping initiation in collar  
HSK-A (hollow shank taper form A) shank according to DIN 69893-1

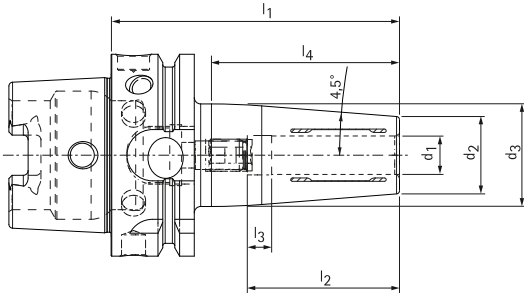

## Preferred series available from stock

HSK-A	Dimensions							G	Torque * [Nm]	Specification	Order no.
	d <sub>1</sub>	d <sub>2</sub>	d <sub>3</sub>	l <sub>1</sub>	l <sub>2</sub>	l <sub>3</sub>	l <sub>4</sub>				
63	6,0	21,0	27,0	80,0	37,0	10,0	48,9	M5	18	MHC-HSK-A063-06-080-1-0-A	31270515
63	6,0	21,0	27,0	120,0	37,0	10,0	48,9	M5	18	MHC-HSK-A063-06-120-1-0-A	31441122
63	8,0	21,0	27,0	80,0	37,0	10,0	48,9	M6	35	MHC-HSK-A063-08-080-1-0-A	31270525
63	8,0	21,0	27,0	120,0	37,0	10,0	48,9	M6	35	MHC-HSK-A063-08-120-1-0-A	31441123
63	10,0	24,0	32,0	85,0	41,0	10,0	53,7	M8x1	60	MHC-HSK-A063-10-085-1-0-A	31270550
63	10,0	24,0	32,0	120,0	41,0	10,0	61,6	M8x1	60	MHC-HSK-A063-10-120-1-0-A	31441124
63	12,0	24,0	32,0	90,0	46,0	10,0	58,6	M10x1	90	MHC-HSK-A063-12-090-1-0-A	31229439
63	12,0	24,0	32,0	120,0	46,0	10,0	61,6	M10x1	90	MHC-HSK-A063-12-120-1-0-A	31441125
63	14,0	27,0	34,0	90,0	46,0	10,0	57,2	M10x1	130	MHC-HSK-A063-14-090-1-0-A	31375071
63	14,0	27,0	34,0	120,0	46,0	10,0	56,2	M10x1	130	MHC-HSK-A063-14-120-1-0-A	31441126
63	16,0	27,0	34,0	95,0	49,0	10,0	63,1	M12x1	200	MHC-HSK-A063-16-095-1-0-A	31270555
63	16,0	27,0	34,0	120,0	49,0	10,0	56,2	M12x1	200	MHC-HSK-A063-16-120-1-0-A	31441127
63	18,0	33,0	42,0	95,0	49,0	10,0	63,0	M12x1	250	MHC-HSK-A063-18-095-1-0-A	31375072
63	18,0	33,0	42,0	120,0	49,0	10,0	68,9	M12x1	250	MHC-HSK-A063-18-120-1-0-A	31441128
63	20,0	33,0	42,0	100,0	51,0	10,0	68,9	M16x1	330	MHC-HSK-A063-20-100-1-0-A	31229440
63	20,0	33,0	42,0	120,0	51,0	10,0	68,9	M16x1	330	MHC-HSK-A063-20-120-1-0-A	31441129
63	25,0	44,0	52,5	115,0	57,0	10,0	85,4	M16x1	500	MHC-HSK-A063-25-115-1-0-A	31396186
63	32,0	44,0	52,5	120,0	61,0	10,0	90,1	M16x1	650	MHC-HSK-A063-32-120-1-0-A	31396187
100	6,0	21,0	27,0	85,0	37,0	10,0	38,7	M5	18	MHC-HSK-A100-06-085-1-0-A	31344789
100	8,0	21,0	27,0	85,0	37,0	10,0	38,7	M6	35	MHC-HSK-A100-08-085-1-0-A	31344860
100	10,0	24,0	32,0	90,0	41,0	10,0	53,7	M8x1	60	MHC-HSK-A100-10-090-1-0-A	31344862
100	12,0	24,0	32,0	95,0	46,0	10,0	58,6	M10x1	90	MHC-HSK-A100-12-095-1-0-A	31344863
100	14,0	27,0	34,0	95,0	46,0	10,0	57,2	M10x1	130	MHC-HSK-A100-14-095-1-0-A	31344864
100	16,0	27,0	34,0	100,0	49,0	10,0	63,1	M12x1	200	MHC-HSK-A100-16-100-1-0-A	31344865
100	18,0	33,0	42,0	100,0	49,0	10,0	63,0	M12x1	250	MHC-HSK-A100-18-100-1-0-A	31344866
100	20,0	33,0	42,0	105,0	51,0	10,0	68,9	M16x1	330	MHC-HSK-A100-20-105-1-0-A	31344867
100	25,0	44,0	53,0	115,0	57,0	10,0	80,7	M16x1	500	MHC-HSK-A100-25-115-1-0-A	31344868
100	32,0	44,0	53,0	120,0	61,0	10,0	84,6	M16x1	650	MHC-HSK-A100-32-120-1-0-A	31344869

\* Permissible transferable torque.

Dimensions in mm.

Use: For clamping tools with smooth cylindrical shanks according to DIN 1835 form A, DIN 6535 form HA as well as with recesses according to DIN 1835 form B, E and DIN 6535 form HB, HE directly and with reducing sleeve in the clamping diameter. The clamping diameter is designed for a shank tolerance of h6.

Scope of delivery: With length adjustment screw, without coolant tube.

Design: Highest tool life and production quality when using smooth cylindrical shanks according to DIN 1835 form A and DIN 6535 form HA. With a projection length of 2.5xD (max. 50 mm) radial run-out accuracy 3 µm. When using cylindrical shanks with an in-

clined clamping surface (form E and form HE), the accuracy may be impaired. Torque transmission perfectly tailored to your application.

Note: Coolant supply via central through hole. Coolant tubes, code carrier, reducing sleeve for reducing the clamping diameter (on the usage of the reducing sleeve the accuracy may be degraded) see section "Accessories, spare parts and measuring equipment". Length adjustment screws available on request.

Balancing quality: G 2.5 with 25,000 rpm in delivery state.

# UNIQ® DReaM Chuck, 4.5°

With axial tool length adjustment, clamping initiation in collar SK shank according to ISO 7388-1 Form AD/AF

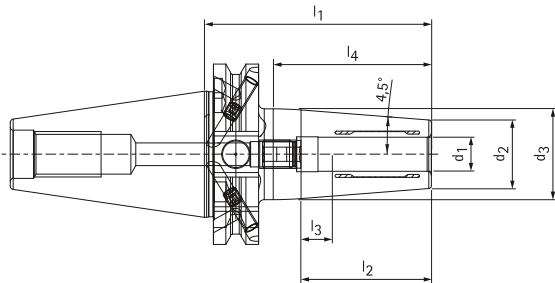

### Preferred series available from stock

Steep taper	Dimensions								G	Torque * [Nm]	Specification	Order no.
	d <sub>1</sub>	d <sub>2</sub>	d <sub>3</sub>	d <sub>4</sub>	l <sub>1</sub>	l <sub>2</sub>	l <sub>3</sub>	l <sub>4</sub>				
40	6,0	21,0	27,0	-	80,0	37,0	10,0	55,7	M5	18	MHC-SK040-06-080-3-0-A	31344880
40	6,0	21,0	27,0	-	120,0	37,0	10,0	48,9	M5	18	MHC-SK040-06-120-3-0-A	31441418
40	8,0	21,0	27,0	-	80,0	37,0	10,0	55,7	M6	35	MHC-SK040-08-080-3-0-A	31344881
40	8,0	21,0	27,0	-	120,0	37,0	10,0	48,9	M6	35	MHC-SK040-08-120-3-0-A	31441419
40	10,0	24,0	32,0	-	80,0	41,0	10,0	55,7	M8x1	60	MHC-SK040-10-080-3-0-A	31344882
40	10,0	24,0	32,0	-	120,0	41,0	10,0	61,6	M8x1	60	MHC-SK040-10-120-3-0-A	31441490
40	12,0	24,0	32,0	-	80,0	46,0	10,0	55,7	M10x1	90	MHC-SK040-12-080-3-0-A	31344883
40	12,0	24,0	32,0	-	120,0	46,0	10,0	61,6	M10x1	90	MHC-SK040-12-120-3-0-A	31441491
40	14,0	27,0	34,0	-	80,0	46,0	10,0	55,8	M10x1	130	MHC-SK040-14-080-3-0-A	31375087
40	14,0	27,0	34,0	-	120,0	46,0	10,0	56,2	M10x1	130	MHC-SK040-14-120-3-0-A	31441492
40	16,0	27,0	34,0	-	80,0	49,0	10,0	55,8	M12x1	200	MHC-SK040-16-080-3-0-A	31344884
40	16,0	27,0	34,0	-	120,0	49,0	10,0	56,2	M12x1	200	MHC-SK040-16-120-3-0-A	31441493
40	18,0	33,0	42,0	-	80,0	49,0	10,0	57,2	M12x1	250	MHC-SK040-18-080-3-0-A	31375088
40	18,0	33,0	42,0	-	120,0	49,0	10,0	68,9	M12x1	250	MHC-SK040-18-120-3-0-A	31441494
40	20,0	33,0	42,0	-	80,0	51,0	10,0	57,2	M16x1	330	MHC-SK040-20-080-3-0-A	31344885
40	20,0	33,0	42,0	-	120,0	51,0	10,0	68,9	M16x1	330	MHC-SK040-20-120-3-0-A	31441495
40	25,0	44,0	53,0	49,0	100,0	57,0	10,0	58,7	M10x1	500	MHC-SK040-25-100-3-0-A	31396194
40	32,0	44,0	53,0	-	100,0	61,0	10,0	58,3	M10x1	650	MHC-SK040-32-100-3-0-A	31396195

\* Permissible transferable torque.

Dimensions in mm.

Use: For clamping tools with smooth cylindrical shanks according to DIN 1835 form A, DIN 6535 form HA as well as with recesses according to DIN 1835 form B, E and DIN 6535 form HB, HE directly and with reducing sleeve in the clamping diameter. The clamping diameter is designed for a shank tolerance of h6.

Scope of delivery: With length adjustment screw, without pull stud.

Design: Highest tool life and production quality when using smooth cylindrical shanks according to DIN 1835 form A and DIN 6535 form HA. With a projection length of 2.5xD (max. 50 mm) radial run-out accuracy 3 µm. When using cylindrical shanks with an in-

clined clamping surface (form E and form HE), the accuracy may be impaired. Torque transmission perfectly tailored to your application.

Note: Coolant supply via central through hole. Pull stud, reducing sleeves to reduce the clamping diameter (if the reducing sleeve is used, the accuracy may be impaired), see section "Accessories and spare parts". Length adjustment screws available on request.

Balancing quality: G 2.5 with 25,000 rpm in delivery state.

## UNIQ® DReaM Chuck, 4.5°

With axial tool length adjustment, clamping initiation in collar  
Shank BT according to ISO 7388-2 Form JD/JF (JIS B 6339)

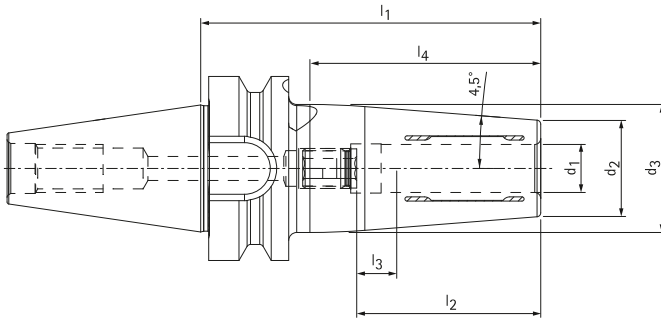

### Preferred series available from stock

BT	Dimensions							G	Torque* [Nm]	Specification	Order no.
	d <sub>1</sub>	d <sub>2</sub>	d <sub>3</sub>	l <sub>1</sub>	l <sub>2</sub>	l <sub>3</sub>	l <sub>4</sub>				
30**	6,0	21,0	27,0	85,0	37,0	10,0	57,7	M5	18	MHC-BT030-06-085-1-0-A	31280360
30**	8,0	21,0	27,0	85,0	37,0	10,0	57,7	M6	35	MHC-BT030-08-085-1-0-A	31280361
30**	10,0	24,0	32,0	85,0	41,0	10,0	57,7	M8x1	60	MHC-BT030-10-085-1-0-A	31280362
30**	12,0	24,0	32,0	85,0	46,0	10,0	57,7	M10x1	90	MHC-BT030-12-085-1-0-A	31280365
30**	14,0	27,0	34,0	85,0	46,0	10,0	57,2	M10x1	130	MHC-BT030-14-085-1-0-A	31375079
30**	16,0	27,0	34,0	85,0	49,0	10,0	57,2	M10x1	200	MHC-BT030-16-085-1-0-A	31280366
30**	18,0	33,0	42,0	85,0	49,0	10,0	57,5	M12x1	250	MHC-BT030-18-085-1-0-A	31375080
30**	20,0	33,0	42,0	85,0	51,0	10,0	57,5	M10x1	330	MHC-BT030-20-085-1-0-A	31280367
40	6,0	21,0	27,0	90,0	37,0	10,0	57,7	M5	18	MHC-BT040-06-090-3-0-A	31344904
40	8,0	21,0	27,0	90,0	37,0	10,0	57,7	M6	35	MHC-BT040-08-090-3-0-A	31344905
40	10,0	24,0	32,0	90,0	41,0	10,0	57,7	M8x1	60	MHC-BT040-10-090-3-0-A	31344906
40	12,0	24,0	32,0	90,0	46,0	10,0	57,7	M10x1	90	MHC-BT040-12-090-3-0-A	31344907
40	14,0	27,0	34,0	90,0	46,0	10,0	57,2	M10x1	130	MHC-BT040-14-090-3-0-A	31396128
40	16,0	27,0	34,0	90,0	49,0	10,0	57,2	M12x1	200	MHC-BT040-16-090-3-0-A	31344908
40	18,0	33,0	42,0	90,0	49,0	10,0	57,5	M12x1	250	MHC-BT040-18-090-3-0-A	31396129
40	20,0	33,0	42,0	90,0	51,0	10,0	57,5	M16x1	330	MHC-BT040-20-090-3-0-A	31344909
40	25,0	44,0	53,0	100,0	57,0	10,0	67,9	M16x1	500	MHC-BT040-25-100-3-0-A	31396140
40	32,0	44,0	53,0	100,0	61,0	10,0	67,9	M16x1	650	MHC-BT040-32-100-3-0-A	31396141

\* Permissible transferable torque.

\*\* Design: Taper shank size is not available in the JD/JF combination design

Dimensions in mm.

Use: For clamping tools with smooth cylindrical shanks according to DIN 1835 form A, DIN 6535 form HA as well as with recesses according to DIN 1835 form B, E and DIN 6535 form HB, HE directly and with reducing sleeve in the clamping diameter. The clamping diameter is designed for a shank tolerance of h6.

Scope of delivery: With length adjustment screw, without pull stud.

Design: Highest tool life and production quality when using smooth cylindrical shanks according to DIN 1835 form A and DIN 6535 form HA. With a projection length of 2.5xD (max. 50 mm) radial run-out accuracy 3 µm. When using cylindrical shanks with an in-

clined clamping surface (form E and form HE), the accuracy may be impaired. Torque transmission perfectly tailored to your application.

Note: Coolant supply via central through hole. Pull stud, reducing sleeves to reduce the clamping diameter. (If the reducing sleeve is used, the accuracy may be impaired), see section "Accessories and spare parts". Length adjustment screws available on request.

Balancing quality: G 2.5 with 25,000 rpm in delivery state.

# UNIQ® DReaM Chuck, 4.5°

With axial tool length adjustment, clamping initiation in collar "CAT" shank in accordance with ASME B5.50-1994

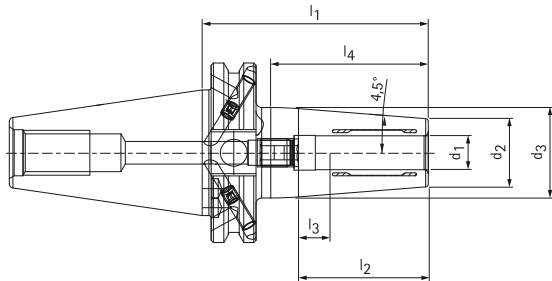

**Preferred series available from stock**

CAT	Dimensions							G	Torque* [Nm]	Specification	Order no.
	d <sub>1</sub>	d <sub>2</sub>	d <sub>3</sub>	l <sub>1</sub>	l <sub>2</sub>	l <sub>3</sub>	l <sub>4</sub>				
40	6,0	21,0	27,0	80,0	37,0	10,0	55,7	M5	18	MHC-CAT040-06-080-3-0-A	31344892
40	8,0	21,0	27,0	80,0	37,0	10,0	55,7	M6	35	MHC-CAT040-08-080-3-0-A	31344893
40	10,0	24,0	32,0	80,0	41,0	10,0	55,7	M8x1	60	MHC-CAT040-10-080-3-0-A	31344894
40	12,0	24,0	32,0	80,0	46,0	10,0	55,7	M10x1	90	MHC-CAT040-12-080-3-0-A	31344895
40	14,0	27,0	34,0	80,0	46,0	10,0	55,8	M10x1	130	MHC-CAT040-14-080-3-0-A	31375095
40	16,0	27,0	34,0	80,0	49,0	10,0	55,8	M12x1	200	MHC-CAT040-16-080-3-0-A	31344896
40	18,0	33,0	42,0	80,0	49,0	10,0	57,2	M12x1	250	MHC-CAT040-18-080-3-0-A	31375096
40	20,0	33,0	42,0	80,0	51,0	10,0	57,2	M16x1	330	MHC-CAT040-20-080-3-0-A	31344897

\* Permissible transferable torque.

Dimensions in mm.

Use: For clamping tools with smooth cylindrical shanks according to DIN 1835 form A, DIN 6535 form HA as well as with recesses according to DIN 1835 form B, E and DIN 6535 form HB, HE directly and with reducing sleeve in the clamping diameter. The clamping diameter is designed for a shank tolerance of h6.

Scope of delivery: With length adjustment screw, without pull stud.

Design: Highest tool life and production quality when using smooth cylindrical shanks according to DIN 1835 form A and DIN 6535 form HA. With a projection length of 2.5xD (max. 50 mm) radial run-out accuracy 3 µm. When using cylindrical shanks with an in-

clined clamping surface (form E and form HE), the accuracy may be impaired. Torque transmission perfectly tailored to your application.

Note: Coolant supply via central through hole. Pull stud, reducing sleeves to reduce the clamping diameter (if the reducing sleeve is used, the accuracy may be impaired), see section "Accessories and spare parts". Length adjustment screws available on request.

Balancing quality: G 2.5 with 25,000 rpm in delivery status.

# HydroChuck

in accordance with DIN 69882-7 with axial tool length adjustment  
 HSK-C shank in accordance with DIN 69893-1

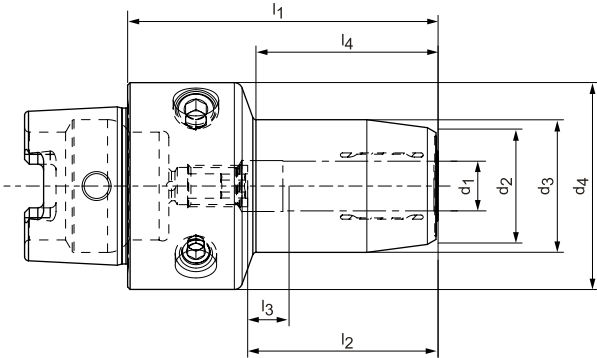

## Preferred series available from stock

HSK-C	Dimensions								G	Specification	Order no.
	$d_1$	$d_2$	$d_3$	$d_4$	$l_1$	$l_2$	$l_3$	$l_4$			
40	6,0	21,5	26,0	40,0	60,0	37,0	10,0	35,0	M5	MHC-HSK-C040-06-060-1-0-A	30251176
40	8,0	23,5	28,0	40,0	60,0	37,0	10,0	36,0	M6	MHC-HSK-C040-08-060-1-0-A	30251177
40	10,0	25,5	30,0	40,0	65,0	41,0	10,0	41,0	M6	MHC-HSK-C040-10-065-1-0-A	30251178
40	12,0	27,5	32,0	40,0	70,0	46,0	10,0	47,0	M6	MHC-HSK-C040-12-070-1-0-A	30251179
50	6,0	21,5	26,0	50,0	60,0	37,0	10,0	30,0	M5	MHC-HSK-C050-06-060-1-0-A	30251180
50	8,0	23,5	28,0	50,0	60,0	37,0	10,0	30,0	M6	MHC-HSK-C050-08-060-1-0-A	30251181
50	10,0	25,5	30,0	50,0	65,0	41,0	10,0	35,0	M8x1	MHC-HSK-C050-10-065-1-0-A	30251182
50	12,0	27,5	32,0	50,0	75,0	46,0	10,0	44,0	M10x1	MHC-HSK-C050-12-075-1-0-A	30251183
50	14,0	29,5	34,0	50,0	75,0	46,0	10,0	46,0	M10x1	MHC-HSK-C050-14-075-1-0-A	30251184
50	16,0	33,5	38,0	50,0	80,0	49,0	10,0	51,0	M12x1	MHC-HSK-C050-16-080-1-0-A	30251185
50	18,0	33,5	40,0	50,0	80,0	49,0	10,0	51,0	M12x1	MHC-HSK-C050-18-080-1-0-A	30251186
50	20,0	37,5	42,0	50,0	80,0	51,0	10,0	52,0	M16x1	MHC-HSK-C050-20-080-1-0-A	30251187

Dimensions in mm.

Additional dimensions available upon request.

Use: For clamping tools with smooth cylindrical shanks according to DIN 1835 form A, DIN 6535 form HA as well as with recesses according to DIN 1835 form B, E and DIN 6535 form HB, HE directly and with reducing sleeve in the clamping diameter. The clamping diameter is designed for a shank tolerance of h6.

Scope of delivery: With length adjustment screw, without coolant tube.

Design: Highest tool life and production quality when using smooth cylindrical shanks according to DIN 1835 form A and DIN 6535 form HA. With a projection length of 2.5xD (max. 50 mm) radial run-out accuracy 3  $\mu$ m. When using cylindrical shanks with an inclined clamping surface (form E and form HE), the accuracy may be impaired.

Note: Coolant supply via central through hole. For coolant tubes, code carriers, reducing sleeves to reduce the clamping diameter (if the reducing sleeve is used, the accuracy may be impaired), see Chapter "Accessories, spare parts and measuring equipment". Length adjustment screws available on request.

Balancing quality: G 2.5 with 25,000 rpm in delivery status.



# HydroChuck

in accordance with DIN 69882-7 with axial tool length adjustment  
 Shank hollow shank taper E according to DIN 69893-5

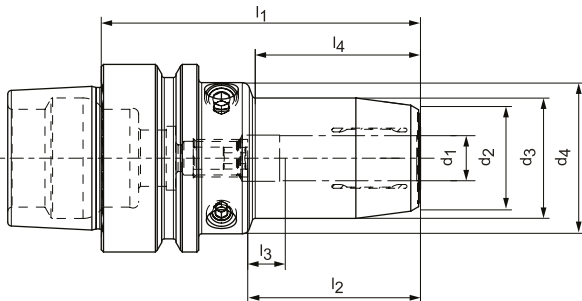

**Preferred series available from stock**

HSK-E	Dimensions										G	Specification	Order no.
	d <sub>1</sub>	d <sub>2</sub>	d <sub>3</sub>	d <sub>4</sub>	d <sub>5</sub>	l <sub>1</sub>	l <sub>2</sub>	l <sub>3</sub>	l <sub>4</sub>	l <sub>5</sub>			
40	6,0	21,5	26,0	33,5	-	70,0	37,0	10,0	36,0	-	M5	MHC-HSK-E040-06-070-1-0-A	30495053
40	8,0	23,5	28,0	33,5	-	70,0	37,0	10,0	36,0	-	M6	MHC-HSK-E040-08-070-1-0-A	30501163
40	10,0	25,5	30,0	33,5	-	75,0	41,0	10,0	42,0	-	M6	MHC-HSK-E040-10-075-1-0-A	30543481
40	12,0	27,5	32,0	33,5	-	80,0	46,0	10,0	48,0	-	M6	MHC-HSK-E040-12-080-1-0-A	30495056
50	6,0	21,5	26,0	40,0	-	70,0	37,0	10,0	28,0	-	M5	MHC-HSK-E050-06-070-1-0-A	30550799
50	8,0	23,5	28,0	40,0	-	70,0	37,0	10,0	28,0	-	M6	MHC-HSK-E050-08-070-1-0-A	30550820
50	10,0	25,5	30,0	40,0	-	75,0	41,0	10,0	34,0	-	M8x1	MHC-HSK-E050-10-075-1-0-A	30550821
50	12,0	27,5	32,0	40,0	-	85,0	46,0	10,0	44,0	-	M10x1	MHC-HSK-E050-12-085-1-0-A	30550822
50	14,0	29,5	34,0	40,0	-	85,0	46,0	10,0	44,0	-	M10x1	MHC-HSK-E050-14-085-1-0-A	30320448
50	16,0	33,5	38,0	53,0	40,0	90,0	49,0	10,0	30,0	48,0	M10x1	MHC-HSK-E050-16-090-1-0-A	30550823
50	18,0	35,5	40,0	53,0	40,0	90,0	49,0	10,0	29,0	48,0	M12x1	MHC-HSK-E050-18-090-1-0-A	30550824
50	20,0	37,5	42,0	57,0	40,0	90,0	51,0	10,0	29,0	48,0	M10x1	MHC-HSK-E050-20-090-1-0-A	30550825

Dimensions in mm.  
 Additional dimensions available upon request.

Use: For clamping tools with smooth cylindrical shanks according to DIN 1835 form A, DIN 6535 form HA as well as with recesses according to DIN 1835 form B, E and DIN 6535 form HB, HE directly and with reducing sleeve in the clamping diameter. The clamping diameter is designed for a shank tolerance of h6.  
 Scope of delivery: With length adjustment screw, without coolant tube.  
 Design: Highest tool life and production quality when using smooth cylindrical shanks according to DIN 1835 form A and DIN 6535 form HA. With a projection length of 2.5xD (max. 50 mm) radial run-out accuracy 3 µm. When using cylindrical shanks with an inclined clamping surface (form E and form HE), the accuracy may be impaired.

Note: Coolant supply via central through hole. For coolant tubes, code carriers, reducing sleeves to reduce the clamping diameter (if the reducing sleeve is used, the accuracy may be impaired), see Chapter "Accessories, spare parts and measuring equipment". Length adjustment screws available on request.  
 Balancing quality: G 2.5 with 25,000 rpm in delivery state.

# Selection system for hydraulic chuck HydroChuck for MQL



Hydraulic chuck <b>HydroChuck</b>	<b>1-channel system</b>	<b>Automatic tool change</b> Preferred series available from stock	HSK-A063 Short, L1=120 HSK-A100 Short	Axial	Page 190
		<b>Automatic tool change</b> Further designs on request	HSK-A040 Short, L1=120, L1=160 HSK-A050 Short, L1=120, L1=160 HSK-A063 L1=160, L1=200 HSK-A080 Short HSK-A100 L1=120, L1=160, L1=200	Axial	Page 191
		<b>Manual tool change</b> Available on request	HSK-A040 Short, L1=120 HSK-A050 Short, L1=120 HSK-A063 L1=120, L1=160, L1=200 HSK-A100 L1=120, L1=160, L1=200	Axial	Page 196
	<b>2-channel system*</b>	<b>Automatic tool change</b> Preferred series available from stock	HSK-A063 Short, L1=120 HSK-A100 Short	Axial	Page 202
		<b>Automatic tool change</b> Further designs on request	HSK-A040 Short, L1=120, L1=160 HSK-A050 Short, L1=120, L1=160 HSK-A063 L1=160, L1=200 HSK-A100 L1=120, L1=160, L1=200	Axial	Page 204
		<b>Manual tool change</b> Available on request			

\* Due to the need to maintain the MQL ratio, up to three different supply units with the related length adjustment screw can be selected for one shank diameter. For more detailed information and a detailed selection system, see page 180 et seqq.

# Selection system for shrink chuck ThermoChuck for MQL

- 1 1-channel system MQL for automatic tool change
- 2 1-channel system MQL for manual tool change
- 3 2-channel system MQL for automatic tool change

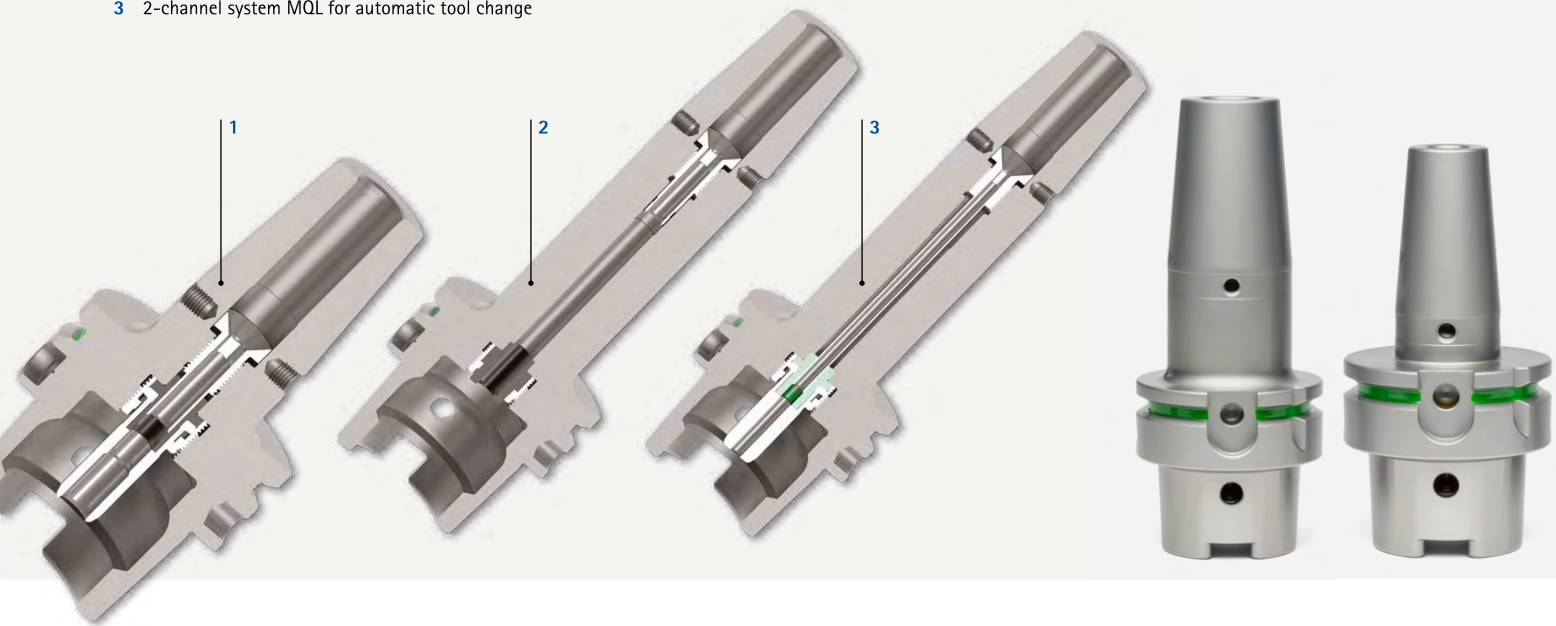

Shrink chuck <b>ThermoChuck</b>	1-channel system	<b>Automatic tool change</b> Preferred series available from stock	HSK-A063 Short, L1=120 HSK-A100 Short	Axial	Page 193
		<b>Automatic tool change</b> Further designs on request	HSK-A040 Short, L1=120, L1=160 HSK-A050 Short, L1=120, L1=160 HSK-A063 L1=160, L1=200 HSK-A100 L1=120, L1=160, L1=200	Axial	Page 194
		<b>Manual tool change</b> Available on request	HSK-A040 Short HSK-A050 Short HSK-A063 Short, L1=120, L1=160, L1=200 HSK-A080 Short HSK-A100 Short, L1=120, L1=160, L1=200	Axial	Page 199
	2-channel system*	<b>Automatic tool change</b> Preferred series available from stock	HSK-A063 Short, L1=120 HSK-A100 Short	Axial	Page 209
		<b>Automatic tool change</b> Further designs on request	HSK-A040 Short, L1=120, L1=160 HSK-A050 Short HSK-A063 L1=160, L1=200 HSK-A080 Short HSK-A100 L1=120, L1=160, L1=200	Axial	Page 211
		<b>Manual tool change</b> Available on request			

\* Due to the need to maintain the MQL ratio, up to three different supply units with the related length adjustment screw can be selected for one shank diameter. For more detailed information and a detailed selection system, see page 180 et seqq.

## Selection of chucks MQL 2-channel system

When selecting chucks for the MQL 2-channel system, it is imperative attention is paid to ensuring the cross-sections of the MQL connections (length adjustment screw and coolant supply unit) match the sum of the cross-sections of all coolant outlets on the tool.

The correct ratio of inlet cross-section  $A_{IN}$  to the outlet cross-section  $A_{OUT}$  is ensured by the so-called MQL ratio. The MQL ratio should be a maximum of 4 and should not be less than 1.

$$\text{MQL ratio} = \frac{A_{IN}}{A_{OUT}}$$

$$1 \leq \text{MQL ratio} \leq 4$$

$A_{IN}$  Defined by the bore diameter on the length adjustment screw

$A_{OUT}$  Defined by the sum of the cross-sections of all coolant outlets on the tool

### NOTE

It is necessary to maintain the MQL ratio for the following reasons:

- Ensuring a continuous supply of oil
- Transporting the entire volume of oil provided by the 2-channel system
- Short reaction times (time from switching on the oil supply to the outlet of the oil-air mixture from the coolant outlets on the tool)

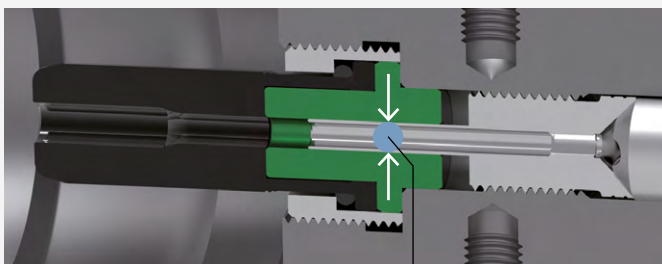
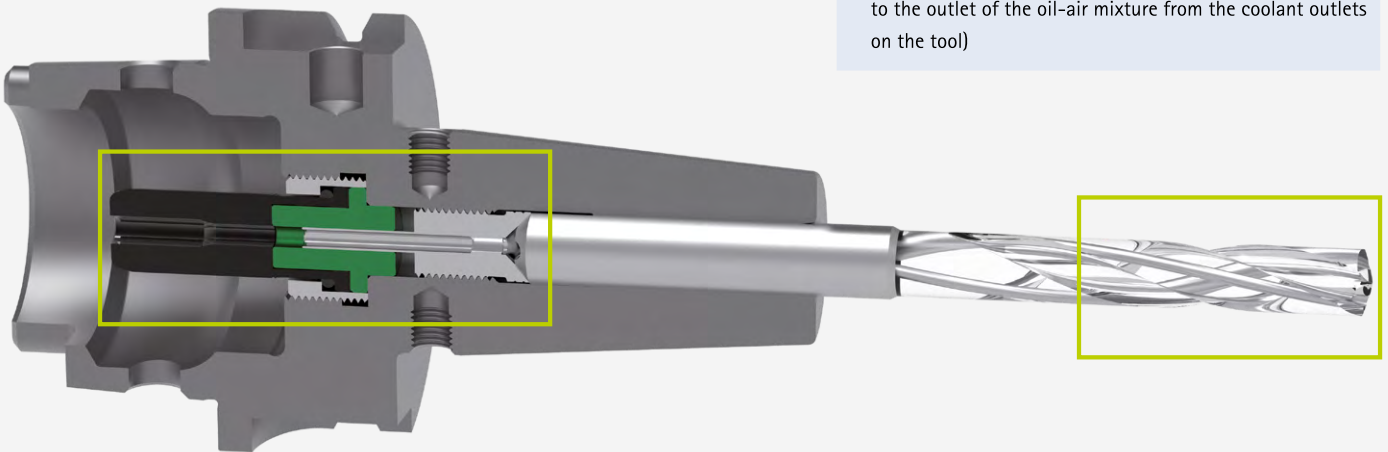

$A_{IN}$

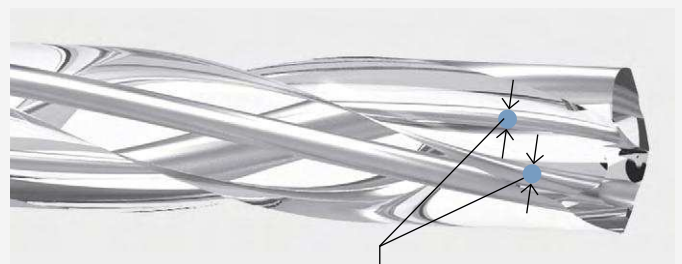

Information on MAPAL drawing for the tool:

$$A_{OUT} = A_{OUT1} + A_{OUT2}$$

Due to the need to maintain the MQL ratio, up to three different coolant supply units with the related length adjustment screw can be selected for one shank diameter. To nevertheless keep the number of variants as low as possible, a Standard or preferred series is defined. Only if the MQL ratio cannot be maintained with this Standard series, the

Semi-Standard 1 is used as the next smaller variant. Should it also not be possible to maintain the MQL ratio with this series, Semi-Standard 2 is used.

**For standard MQL tools, for example solid carbide drills, use the selection aid with examples on the following pages.**

**Definition of the variants Standard, Semi-Standard 1 and Semi-Standard 2**

Cross-sectional area  $A_{IN}$ , inside diameter  $d_i$  and width across flat (AF) for the length adjustment screw as a function of the shank diameter and the HSK size

Hollow shank taper size	Shank $\varnothing$	Standard			Semi-Standard 1			Semi-Standard 2		
		$A_{IN}$ [mm <sup>2</sup> ]	$d_i$ [mm]	AF	$A_{IN}$ [mm <sup>2</sup> ]	$d_i$ [mm]	AF	$A_{IN}$ [mm <sup>2</sup> ]	$d_i$ [mm]	AF
32	06 – 12	4,52	2,40	2	1,54	1,40	1,5	–	–	–
40 - 100	06 – 10	4,52	2,40	2	1,54	1,40	1,5	–	–	–
	12 – 18	9,90	3,55	3	4,52	2,40	2	1,54	1,40	1,5
	20 – 32	17,35	4,70	4	9,90	3,55	3	4,52	2,40	2

Procedure for the selection of the variants Standard, Semi-Standard 1 and Semi-Standard 2  
 Inlet cross-sections  $A_{IN}$  can be taken from the table above for the calculation of the MQL ratio.

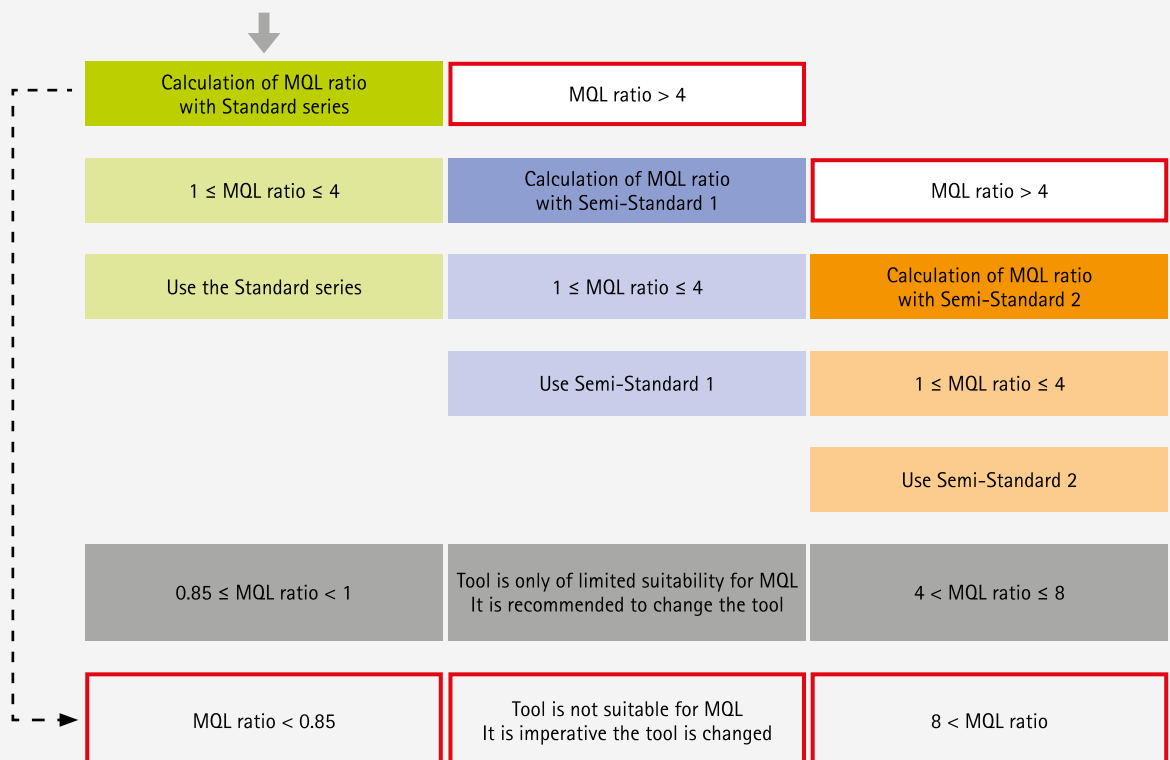

# Selection system example for determining the variant for 2-channel systems

The following selection aids can be used to select the chuck more quickly and straightforwardly. The procedure is defined in the following.

- ① Selection of the table according to the shank diameter
- ② Selection of the range based on the number and diameter of the cooling channels
- ③ Determination of the series via colour coding

## Example 1

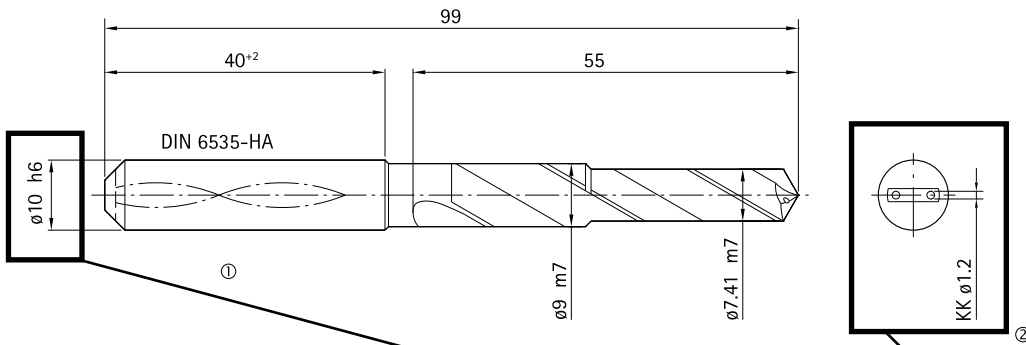

Connection ø:		6 - 10		Standard / AF 2		Semi-standard 1 / AF 1.5		MQL ratio with AF 1.5 too small and with AF 2 too large		Permissible with limitations																
Number of cooling channels	Cooling channel ø		0,3		0,4		0,5		0,6		0,7		0,8		0,9		1,0		1,1		1,2		1,3		1,4	
	A <sub>0ur</sub> [mm <sup>2</sup> ]	MQL ratio	A <sub>0ur</sub> [mm <sup>2</sup> ]	MQL ratio	A <sub>0ur</sub> [mm <sup>2</sup> ]	MQL ratio	A <sub>0ur</sub> [mm <sup>2</sup> ]	MQL ratio	A <sub>0ur</sub> [mm <sup>2</sup> ]	MQL ratio	A <sub>0ur</sub> [mm <sup>2</sup> ]	MQL ratio	A <sub>0ur</sub> [mm <sup>2</sup> ]	MQL ratio	A <sub>0ur</sub> [mm <sup>2</sup> ]	MQL ratio	A <sub>0ur</sub> [mm <sup>2</sup> ]	MQL ratio	A <sub>0ur</sub> [mm <sup>2</sup> ]	MQL ratio	A <sub>0ur</sub> [mm <sup>2</sup> ]	MQL ratio	A <sub>0ur</sub> [mm <sup>2</sup> ]	MQL ratio	A <sub>0ur</sub> [mm <sup>2</sup> ]	MQL ratio
	1	0,07	21,78	0,13	12,25	0,20	7,84	0,28	5,44	0,38	4,00	0,50	3,06	0,64	2,42	0,79	1,96	0,95	1,62			1,13	4,00	1,33	3,41	1,54
2	0,14	10,89	0,25	6,13	0,39	3,92	0,57	2,72	0,77	2,00	1,01	1,53	1,27	3,56	1,57	2,88	1,90	2,38			2,26	2,00	2,65	1,70	3,08	1,47
3	0,21	7,26	0,38	4,08	0,59	2,61	0,85	1,81	1,15	3,92	1,51	3,00	1,91	2,37	2,36	1,92	2,85	1,59			3,39	1,33	3,98	1,14	4,62	0,98
4	0,28	5,44	0,50	3,06	0,79	1,96	1,13	4,00	1,54	2,94	2,01	2,25	2,54	1,78	3,14	1,44	3,80	1,19			4,52	1,00	5,31	0,85	6,16	
5	0,35	4,36	0,63	2,45	0,98	1,57	1,41	3,20	1,92	2,35	2,51	1,80	3,18	1,42	3,93	1,15	4,75	0,85			5,65		6,64		7,70	
6	0,42	3,63	0,75	2,04	1,18	3,84	1,70	2,67	2,31	1,96	3,02	1,50	3,82	1,19	4,71	0,96	5,70				6,79		7,96		9,24	
7	0,49	3,11	0,88	1,75	1,37	3,29	1,98	2,29	2,69	1,68	3,52	1,29	4,45	1,02	5,50		6,65				7,92		9,29		10,78	
8	0,57	2,72	1,01	1,53	1,57	2,88	2,26	2,00	3,08	1,47	4,02	1,13	5,09	0,88	6,28		7,60				9,05		10,62		12,32	

Variante*	HSK-A	Baumaße						G	A <sub>IN</sub>	sw	Komponenten			Spezifikation	Bestell-Nr.	
		d <sub>1</sub>	d <sub>2</sub>	d <sub>3</sub>	l <sub>1</sub>	l <sub>2</sub>	l <sub>3</sub>				l <sub>4</sub>	BDY	LS			CU
	63	6	26	45	80	36	10	37	M10x1	1,54	1,5	30386549	30512784	30512203	MHC-HSK-A063-06-080-C-0-A-AAA1	30522882
	63	6	26	45	80	36	10	37	M10x1	4,52	2	30386549	30384039	30384304	MHC-HSK-A063-06-080-C-0-A-AAA2	30386278
	63	6	26	38	120	36	10	78	M5	1,54	1,5	30464609	30512804	30512203	MHC-HSK-A063-06-120-C-0-A-AAA1	30522916
	63	6	26	38	120	36	10	78	M5	4,52	2	30464609	30384040	30384304	MHC-HSK-A063-06-120-C-0-A-AAA2	30485332
	63	8	28	45	80	36	10	37,5	M10x1	1,54	1,5	30386550	30512785	30512203	MHC-HSK-A063-08-080-C-0-A-AAA1	30522883
	63	8	28	45	80	36	10	37,5	M10x1	4,52	2	30386550	30384043	30384304	MHC-HSK-A063-08-080-C-0-A-AAA2	30386279
	63	8	28	38	120	36	10	78,5	M7	1,54	1,5	30464610	30512805	30512203	MHC-HSK-A063-08-120-C-0-A-AAA1	30522917
	63	8	28	38	120	36	10	78,5	M7	4,52	2	30464610	30384044	30384304	MHC-HSK-A063-08-120-C-0-A-AAA2	30485333
	63	10	30	45	85	40	10	43,5	M10x1	1,54	1,5	30386551	30512786	30512203	MHC-HSK-A063-10-085-C-0-A-AAA1	30522884
	63	10	30	45	85	40	10	43,5	M10x1	4,52	2	30386551	30384011	30384304	MHC-HSK-A063-10-085-C-0-A-AAA2	30386280
	63	10	30	40	120	40	10	79	M8x1	1,54	1,5	30464611	30512806	30512203	MHC-HSK-A063-10-120-C-0-A-AAA1	30522918
	63	10	30	40	120	40	10	79	M8x1	4,52	2	30464611	30384012	30384304	MHC-HSK-A063-10-120-C-0-A-AAA2	30485334
	63	12	32	45	90	45	10	49	M10x1	1,54	1,5	30386552	30512791	30512203	MHC-HSK-A063-12-090-C-0-A-AAA1	30522885

Calculation of the MQL ratio taking into account the inlet cross-section A<sub>IN</sub> Semi-Standard 1 variant.

- ① Selection of the table according to the shank diameter
- ② Selection of the range based on the number and diameter of the cooling channels
- ③ Determination of the series via colour coding

Example 2

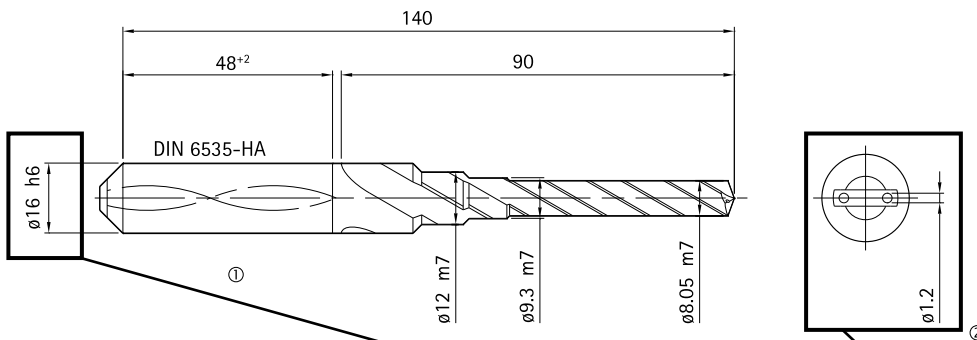

Cooling channel ø		0,3		0,4		0,5		0,6		0,7		0,8		0,9		1,0		1,1		1,2		1,3		1,4	
		A <sub>out</sub> [mm <sup>2</sup> ]	MQL ratio	A <sub>out</sub> [mm <sup>2</sup> ]	MQL ratio	A <sub>out</sub> [mm <sup>2</sup> ]	MQL ratio	A <sub>out</sub> [mm <sup>2</sup> ]	MQL ratio	A <sub>out</sub> [mm <sup>2</sup> ]	MQL ratio	A <sub>out</sub> [mm <sup>2</sup> ]	MQL ratio	A <sub>out</sub> [mm <sup>2</sup> ]	MQL ratio	A <sub>out</sub> [mm <sup>2</sup> ]	MQL ratio	A <sub>out</sub> [mm <sup>2</sup> ]	MQL ratio	A <sub>out</sub> [mm <sup>2</sup> ]	MQL ratio	A <sub>out</sub> [mm <sup>2</sup> ]	MQL ratio	A <sub>out</sub> [mm <sup>2</sup> ]	MQL ratio
Number of cooling channels	1	0,07	21,78	0,13	12,25	0,20	7,84	0,28	5,44	0,38	4,00	0,50	3,06	0,64	2,42	0,79	1,96	0,95	1,62	1,13	4,00	1,33	3,41	1,54	2,94
	2	0,14	10,89	0,25	6,13	0,39	3,92	0,57	2,72	0,77	2,00	1,01	1,53	1,27	3,56	1,57	2,88	1,90	2,38	2,26	2,00	2,65	3,73	3,08	3,21
	3	0,21	7,26	0,38	4,08	0,59	2,61	0,85	1,81	1,15	3,92	1,51	3,00	1,91	2,37	2,36	1,92	2,85	3,47	3,39	2,92	3,98	2,49	4,62	2,14
	4	0,28	5,44	0,50	3,06	0,79	1,96	1,13	4,00	1,54	2,94	2,01	2,25	2,54	3,89	3,14	3,15	3,80	2,60	4,52	2,19	5,31	1,86	6,16	1,61
	5	0,35	4,36	0,63	2,45	0,98	1,57	1,41	3,20	1,92	2,35	2,51	3,94	3,18	3,11	3,93	2,52	4,75	2,08	5,65	1,75	6,64	1,49	7,70	1,29
	6	0,42	3,63	0,75	2,04	1,18	3,84	1,70	2,67	2,31	4,29	3,02	3,28	3,82	2,59	4,71	2,10	5,70	1,74	6,79	1,46	7,96	1,24	9,24	1,07
	7	0,49	3,11	0,88	1,75	1,37	3,29	1,98	2,29	2,69	3,67	3,52	2,81	4,45	2,22	5,50	1,80	6,65	1,49	7,92	1,25	9,29	1,07	10,78	0,92

Variante*	HSK-A	Baumaße						G	A <sub>IN</sub>	sw	Komponenten			Spezifikation			Bestell-Nr.
		d <sub>1</sub>	d <sub>2</sub>	d <sub>3</sub>	l <sub>1</sub>	l <sub>2</sub>	l <sub>3</sub>				BDY	LS	CU				
	63	6	21	27	80	36	10	M10x1	1,54	1,5	10083235	30512784	30512203	MTC-HSK-A063-06-080-C-0-A-AAA1			30521882
	63	6	21	27	80	36	10	M10x1	4,52	2	10083235	30384039	30384304	MTC-HSK-A063-06-080-C-0-A-AAA2			30385638
	63	6	21	27	120	36	10	M5	1,54	1,5	30386128	30512804	30512203	MTC-HSK-A063-06-120-C-0-A-AAA1			30521884
	63	6	21	27	120	36	10	M5	4,52	2	30386128	30384040	30384304	MTC-HSK-A063-06-120-C-0-A-AAA2			30385658
	63	8	21	27	80	36	10	M10x1	1,54	1,5	10083236	30512785	30512203	MTC-HSK-A063-08-080-C-0-A-AAA1			30521890
	63	8	21	27	80	36	10	M10x1	4,52	2	10083236	30384043	30384304	MTC-HSK-A063-08-080-C-0-A-AAA2			30385639
	63	8	21	27	120	36	10	M7	1,54	1,5	30386129	30512805	30512203	MTC-HSK-A063-08-120-C-0-A-AAA1			30521892
	63	8	21	27	120	36	10	M7	4,52	2	30386129	30384044	30384304	MTC-HSK-A063-08-120-C-0-A-AAA2			30385659
	63	10	24	32	85	40	10	M10x1	1,54	1,5	10083237	30512786	30512203	MTC-HSK-A063-10-085-C-0-A-AAA1			30521898
	63	10	24	32	85	40	10	M10x1	4,52	2	10083237	30384011	30384304	MTC-HSK-A063-10-085-C-0-A-AAA2			30385640
	63	10	24	32	120	40	10	M8x1	1,54	1,5	30386800	30512806	30512203	MTC-HSK-A063-10-120-C-0-A-AAA1			30521900
	63	10	24	32	120	40	10	M8x1	4,52	2	30386800	30384012	30384304	MTC-HSK-A063-10-120-C-0-A-AAA2			30385660
	63	12	24	32	90	45	10	M10x1	1,54	1,5	10083238	30512791	30512203	MTC-HSK-A063-12-090-C-0-A-AAA1			30521906

Calculation of the MQL ratio taking into account the inlet cross-section A<sub>IN</sub> Semi-Standard 1 variant.

# Selection system for determining the variant

For 2-channel system chucks with diameter 6–10 mm

		Mounting diameter																		6 - 10	
																				Standard / AF 2	
																				Semi-standard 1 / AF 1.5	
		Cooling channel diameter																		MQL ratio with AF 1.5 too small and with AF 2 too large	
		0,3		0,4		0,5		0,6		0,7		0,8		0,9		1,0		1,1			
		A <sub>out</sub> [mm <sup>2</sup> ]	MQL ratio	A <sub>out</sub> [mm <sup>2</sup> ]	MQL ratio	A <sub>out</sub> [mm <sup>2</sup> ]	MQL ratio	A <sub>out</sub> [mm <sup>2</sup> ]	MQL ratio	A <sub>out</sub> [mm <sup>2</sup> ]	MQL ratio	A <sub>out</sub> [mm <sup>2</sup> ]	MQL ratio	A <sub>out</sub> [mm <sup>2</sup> ]	MQL ratio	A <sub>out</sub> [mm <sup>2</sup> ]	MQL ratio	A <sub>out</sub> [mm <sup>2</sup> ]	MQL ratio		
Number of cooling channels	1	0,07	21,78	0,13	12,25	0,20	7,84	0,28	5,44	0,38	4,00	0,50	3,06	0,64	2,42	0,79	1,96	0,95	1,62		
	2	0,14	10,89	0,25	6,13	0,39	3,92	0,57	2,72	0,77	2,00	1,01	1,53	1,27	3,56	1,57	2,88	1,90	2,38		
	3	0,21	7,26	0,38	4,08	0,59	2,61	0,85	1,81	1,15	3,92	1,51	3,00	1,91	2,37	2,36	1,92	2,85	1,59		
	4	0,28	5,44	0,50	3,06	0,79	1,96	1,13	4,00	1,54	2,94	2,01	2,25	2,54	1,78	3,14	1,44	3,80	1,19		
	5	0,35	4,36	0,63	2,45	0,98	1,57	1,41	3,20	1,92	2,35	2,51	1,80	3,18	1,42	3,93	1,15	4,75	0,95		
	6	0,42	3,63	0,75	2,04	1,18	3,84	1,70	2,67	2,31	1,96	3,02	1,50	3,82	1,19	4,71	0,96	5,70			
	7	0,49	3,11	0,88	1,75	1,37	3,29	1,98	2,29	2,69	1,68	3,52	1,29	4,45	1,02	5,50		6,65			
	8	0,57	2,72	1,01	1,53	1,57	2,88	2,26	2,00	3,08	1,47	4,02	1,13	5,09	0,89	6,28		7,60			
Number of cooling channels		2,2		2,3		2,4		2,5		2,6		2,7		2,8		2,9		3,0			
		A <sub>out</sub> [mm <sup>2</sup> ]	MQL ratio	A <sub>out</sub> [mm <sup>2</sup> ]	MQL ratio	A <sub>out</sub> [mm <sup>2</sup> ]	MQL ratio	A <sub>out</sub> [mm <sup>2</sup> ]	MQL ratio	A <sub>out</sub> [mm <sup>2</sup> ]	MQL ratio	A <sub>out</sub> [mm <sup>2</sup> ]	MQL ratio	A <sub>out</sub> [mm <sup>2</sup> ]	MQL ratio	A <sub>out</sub> [mm <sup>2</sup> ]	MQL ratio	A <sub>out</sub> [mm <sup>2</sup> ]	MQL ratio		
	1	3,80	1,19	4,15	1,09	4,52	1,00	4,91	0,92	5,31		5,73		6,16		6,61		7,07			
	2	7,60		8,31		9,05		9,82		10,62		11,45		12,32		13,21		14,14			
	3	11,40		12,46		13,57		14,73		15,93		17,18		18,47		19,82		21,21			
	4	15,21		16,62		18,10		19,63		21,24		22,90		24,63		26,42		28,27			
	5	19,01		20,77		22,62		24,54		26,55		28,63		30,79		33,03		35,34			
	6	22,81		24,93		27,14		29,45		31,86		34,35		36,95		39,63		42,41			
7	26,61		29,08		31,67		34,36		37,17		40,08		43,10		46,24		49,48				
8	30,41		33,24		36,19		39,27		42,47		45,80		49,26		52,84		56,55				



Permissible with limitations

1,2		1,3		1,4		1,5		1,6		1,7		1,8		1,9		2,0		2,1	
A <sub>OUT</sub> [mm <sup>2</sup> ]	MQL ratio	A <sub>OUT</sub> [mm <sup>2</sup> ]	MQL ratio	A <sub>OUT</sub> [mm <sup>2</sup> ]	MQL ratio	A <sub>OUT</sub> [mm <sup>2</sup> ]	MQL ratio	A <sub>OUT</sub> [mm <sup>2</sup> ]	MQL ratio	A <sub>OUT</sub> [mm <sup>2</sup> ]	MQL ratio	A <sub>OUT</sub> [mm <sup>2</sup> ]	MQL ratio	A <sub>OUT</sub> [mm <sup>2</sup> ]	MQL ratio	A <sub>OUT</sub> [mm <sup>2</sup> ]	MQL ratio	A <sub>OUT</sub> [mm <sup>2</sup> ]	MQL ratio
1,13	4,00	1,33	3,41	1,54	2,94	1,77	2,56	2,01	2,25	2,27	1,99	2,54	1,78	2,84	1,60	3,14	1,44	3,46	1,31
2,26	2,00	2,65	1,70	3,08	1,47	3,53	1,28	4,02	1,13	4,54	1,00	5,09	0,89	5,67		6,28		6,93	
3,39	1,33	3,98	1,14	4,62	0,98	5,30		6,03		6,81		7,63		8,51		9,42		10,39	
4,52	1,00	5,31	0,85	6,16		7,07		8,04		9,08		10,18		11,34		12,57		13,85	
5,65		6,64		7,70		8,84		10,05		11,35		12,72		14,18		15,71		17,32	
6,79		7,96		9,24		10,60		12,06		13,62		15,27		17,01		18,85		20,78	
7,92		9,29		10,78		12,37		14,07		15,89		17,81		19,85		21,99		24,25	
9,05		10,62		12,32		14,14		16,08		18,16		20,36		22,68		25,13		27,71	
3,1		3,2		3,3		3,4		3,5		3,6		3,7		3,8		3,9		4,0	
A <sub>OUT</sub> [mm <sup>2</sup> ]	MQL ratio	A <sub>OUT</sub> [mm <sup>2</sup> ]	MQL ratio	A <sub>OUT</sub> [mm <sup>2</sup> ]	MQL ratio	A <sub>OUT</sub> [mm <sup>2</sup> ]	MQL ratio	A <sub>OUT</sub> [mm <sup>2</sup> ]	MQL ratio	A <sub>OUT</sub> [mm <sup>2</sup> ]	MQL ratio	A <sub>OUT</sub> [mm <sup>2</sup> ]	MQL ratio	A <sub>OUT</sub> [mm <sup>2</sup> ]	MQL ratio	A <sub>OUT</sub> [mm <sup>2</sup> ]	MQL ratio	A <sub>OUT</sub> [mm <sup>2</sup> ]	MQL ratio
7,55		8,04		8,55		9,08		9,62		10,18		10,75		11,34		11,95		12,57	
15,10		16,08		17,11		18,16		19,24		20,36		21,50		22,68		23,89		25,13	
22,64		24,13		25,66		27,24		28,86		30,54		32,26		34,02		35,84		37,70	
30,19		32,17		34,21		36,32		38,48		40,72		43,01		45,36		47,78		50,27	
37,74		40,21		42,76		45,40		48,11		50,89		53,76		56,71		59,73		62,83	
45,29		48,25		51,32		54,48		57,73		61,07		64,51		68,05		71,68		75,40	
52,83		56,30		59,87		63,55		67,35		71,25		75,26		79,39		83,62		87,96	
60,38		64,34		68,42		72,63		76,97		81,43		86,02		90,73		95,57		100,53	



Taking into account the MQL ratio to be maintained for the 2-channel system, the tool is not suitable for MQL. It is imperative the tool is changed.

# Selection system for determining the variant

For 2-channel system chucks with diameter 12–18 mm

		Mounting diameter																		12 - 18	
																				Standard / AF 3	
																				Semi-standard 1 / AF 2	
		Cooling channel diameter																		Semi-standard 2 / AF 1.5	
		0,3		0,4		0,5		0,6		0,7		0,8		0,9		1,0		1,1			
		A <sub>out</sub> [mm <sup>2</sup> ]	MQL ratio	A <sub>out</sub> [mm <sup>2</sup> ]	MQL ratio	A <sub>out</sub> [mm <sup>2</sup> ]	MQL ratio	A <sub>out</sub> [mm <sup>2</sup> ]	MQL ratio	A <sub>out</sub> [mm <sup>2</sup> ]	MQL ratio	A <sub>out</sub> [mm <sup>2</sup> ]	MQL ratio	A <sub>out</sub> [mm <sup>2</sup> ]	MQL ratio	A <sub>out</sub> [mm <sup>2</sup> ]	MQL ratio	A <sub>out</sub> [mm <sup>2</sup> ]	MQL ratio	A <sub>out</sub> [mm <sup>2</sup> ]	MQL ratio
Number of cooling channels	1	0,07	21,78	0,13	12,25	0,20	7,84	0,28	5,44	0,38	4,00	0,50	3,06	0,64	2,42	0,79	1,96	0,95	1,62		
	2	0,14	10,89	0,25	6,13	0,39	3,92	0,57	2,72	0,77	2,00	1,01	1,53	1,27	3,56	1,57	2,88	1,90	2,38		
	3	0,21	7,26	0,38	4,08	0,59	2,61	0,85	1,81	1,15	3,92	1,51	3,00	1,91	2,37	2,36	1,92	2,85	3,47		
	4	0,28	5,44	0,50	3,06	0,79	1,96	1,13	4,00	1,54	2,94	2,01	2,25	2,54	3,89	3,14	3,15	3,80	2,60		
	5	0,35	4,36	0,63	2,45	0,98	1,57	1,41	3,20	1,92	2,35	2,51	3,94	3,18	3,11	3,93	2,52	4,75	2,08		
	6	0,42	3,63	0,75	2,04	1,18	3,84	1,70	2,67	2,31	4,29	3,02	3,28	3,82	2,59	4,71	2,10	5,70	1,74		
	7	0,49	3,11	0,88	1,75	1,37	3,29	1,98	2,29	2,69	3,67	3,52	2,81	4,45	2,22	5,50	1,80	6,65	1,49		
	8	0,57	2,72	1,01	1,53	1,57	2,88	2,26	2,00	3,08	3,21	4,02	2,46	5,09	1,94	6,28	1,58	7,60	1,30		
Number of cooling channels		2,2		2,3		2,4		2,5		2,6		2,7		2,8		2,9		3,0			
		A <sub>out</sub> [mm <sup>2</sup> ]	MQL ratio	A <sub>out</sub> [mm <sup>2</sup> ]	MQL ratio	A <sub>out</sub> [mm <sup>2</sup> ]	MQL ratio	A <sub>out</sub> [mm <sup>2</sup> ]	MQL ratio	A <sub>out</sub> [mm <sup>2</sup> ]	MQL ratio	A <sub>out</sub> [mm <sup>2</sup> ]	MQL ratio	A <sub>out</sub> [mm <sup>2</sup> ]	MQL ratio	A <sub>out</sub> [mm <sup>2</sup> ]	MQL ratio	A <sub>out</sub> [mm <sup>2</sup> ]	MQL ratio	A <sub>out</sub> [mm <sup>2</sup> ]	MQL ratio
	1	3,80	2,60	4,15	2,38	4,52	2,19	4,91	2,02	5,31	1,86	5,73	1,73	6,16	1,61	6,61	1,50	7,07	1,40		
	2	7,60	1,30	8,31	1,19	9,05	1,09	9,82	1,01	10,62	0,93	11,45	0,86	12,32		13,21		14,14			
	3	11,40	0,87	12,46		13,57		14,73		15,93		17,18		18,47		19,82		21,21			
	4	15,21		16,62		18,10		19,63		21,24		22,90		24,63		26,42		28,27			
	5	19,01		20,77		22,62		24,54		26,55		28,63		30,79		33,03		35,34			
	6	22,81		24,93		27,14		29,45		31,86		34,35		36,95		39,63		42,41			
7	26,61		29,08		31,67		34,36		37,17		40,08		43,10		46,24		49,48				
8	30,41		33,24		36,19		39,27		42,47		45,80		49,26		52,84		56,55				

Permissible with limitations

	1,2		1,3		1,4		1,5		1,6		1,7		1,8		1,9		2,0		2,1	
	A <sub>out</sub> [mm <sup>2</sup> ]	MQL ratio	A <sub>out</sub> [mm <sup>2</sup> ]	MQL ratio	A <sub>out</sub> [mm <sup>2</sup> ]	MQL ratio	A <sub>out</sub> [mm <sup>2</sup> ]	MQL ratio	A <sub>out</sub> [mm <sup>2</sup> ]	MQL ratio	A <sub>out</sub> [mm <sup>2</sup> ]	MQL ratio	A <sub>out</sub> [mm <sup>2</sup> ]	MQL ratio	A <sub>out</sub> [mm <sup>2</sup> ]	MQL ratio	A <sub>out</sub> [mm <sup>2</sup> ]	MQL ratio	A <sub>out</sub> [mm <sup>2</sup> ]	MQL ratio
	1,13	4,00	1,33	3,41	1,54	2,94	1,77	2,56	2,01	2,25	2,27	1,99	2,54	3,89	2,84	3,49	3,14	3,15	3,46	2,86
	2,26	2,00	2,65	3,73	3,08	3,21	3,53	2,80	4,02	2,46	4,54	2,18	5,09	1,94	5,67	1,75	6,28	1,58	6,93	1,43
	3,39	2,92	3,98	2,49	4,62	2,14	5,30	1,87	6,03	1,64	6,81	1,45	7,63	1,30	8,51	1,16	9,42	1,05	10,39	0,95
	4,52	2,19	5,31	1,86	6,16	1,61	7,07	1,40	8,04	1,23	9,08	1,09	10,18	0,97	11,34	0,87	12,57		13,85	
	5,65	1,75	6,64	1,49	7,70	1,29	8,84	1,12	10,05	0,98	11,35	0,87	12,72		14,18		15,71		17,32	
	6,79	1,46	7,96	1,24	9,24	1,07	10,60	0,93	12,06		13,62		15,27		17,01		18,85		20,78	
	7,92	1,25	9,29	1,07	10,78	0,92	12,37		14,07		15,89		17,81		19,85		21,99		24,25	
	9,05	1,09	10,62	0,93	12,32		14,14		16,08		18,16		20,36		22,68		25,13		27,71	
	3,1		3,2		3,3		3,4		3,5		3,6		3,7		3,8		3,9		4,0	
	A <sub>out</sub> [mm <sup>2</sup> ]	MQL ratio	A <sub>out</sub> [mm <sup>2</sup> ]	MQL ratio	A <sub>out</sub> [mm <sup>2</sup> ]	MQL ratio	A <sub>out</sub> [mm <sup>2</sup> ]	MQL ratio	A <sub>out</sub> [mm <sup>2</sup> ]	MQL ratio	A <sub>out</sub> [mm <sup>2</sup> ]	MQL ratio	A <sub>out</sub> [mm <sup>2</sup> ]	MQL ratio	A <sub>out</sub> [mm <sup>2</sup> ]	MQL ratio	A <sub>out</sub> [mm <sup>2</sup> ]	MQL ratio	A <sub>out</sub> [mm <sup>2</sup> ]	MQL ratio
	7,55	1,31	8,04	1,23	8,55	1,16	9,08	1,09	9,62	1,03	10,18		10,75		11,34		11,95		12,57	
	15,10		16,08		17,11		18,16		19,24		20,36		21,50		22,68		23,89		25,13	
	22,64		24,13		25,66		27,24		28,86		30,54		32,26		34,02		35,84		37,70	
	30,19		32,17		34,21		36,32		38,48		40,72		43,01		45,36		47,78		50,27	
	37,74		40,21		42,76		45,40		48,11		50,89		53,76		56,71		59,73		62,83	
	45,29		48,25		51,32		54,48		57,73		61,07		64,51		68,05		71,68		75,40	
	52,83		56,30		59,87		63,55		67,35		71,25		75,26		79,39		83,62		87,96	
	60,38		64,34		68,42		72,63		76,97		81,43		86,02		90,73		95,57		100,53	



Taking into account the MQL ratio to be maintained for the 2-channel system, the tool is not suitable for MQL. It is imperative the tool is changed.

# Selection system for determining the variant

For 2-channel system chucks with diameter 20–32 mm

		Mounting diameter																		20 - 32	
																				Standard / AF 4	
																				Semi-Standard 1 / AF 3	
																				Semi-Standard 2 / AF 2	
																				MQL ratio with AF 2 too small and with AF 4 too large	
		Cooling channel diameter																			
		0,3		0,4		0,5		0,6		0,7		0,8		0,9		1,0		1,1			
		A <sub>out</sub> [mm <sup>2</sup> ]	MQL ratio	A <sub>out</sub> [mm <sup>2</sup> ]	MQL ratio	A <sub>out</sub> [mm <sup>2</sup> ]	MQL ratio	A <sub>out</sub> [mm <sup>2</sup> ]	MQL ratio	A <sub>out</sub> [mm <sup>2</sup> ]	MQL ratio	A <sub>out</sub> [mm <sup>2</sup> ]	MQL ratio	A <sub>out</sub> [mm <sup>2</sup> ]	MQL ratio	A <sub>out</sub> [mm <sup>2</sup> ]	MQL ratio	A <sub>out</sub> [mm <sup>2</sup> ]	MQL ratio	A <sub>out</sub> [mm <sup>2</sup> ]	MQL ratio
Number of cooling channels	1	0,07		0,13		0,20		0,28		0,38		0,50		0,64	7,11	0,79	5,76	0,95	4,76		
	2	0,14		0,25		0,39		0,57	8,00	0,77	5,88	1,01	4,50	1,27	3,56	1,57	2,88	1,90	2,38		
	3	0,21		0,38		0,59	7,68	0,85	5,33	1,15	3,92	1,51	3,00	1,91	2,37	2,36	1,92	2,85	3,47		
	4	0,28		0,50		0,79	5,76	1,13	4,00	1,54	2,94	2,01	2,25	2,54	3,89	3,14	3,15	3,80	2,60		
	5	0,35		0,63	7,20	0,98	4,61	1,41	3,20	1,92	2,35	2,51	3,94	3,18	3,11	3,93	2,52	4,75	3,65		
	6	0,42		0,75	6,00	1,18	3,84	1,70	2,67	2,31	1,96	3,02	3,28	3,82	2,59	4,71	3,68	5,70	3,04		
	7	0,49		0,88	5,14	1,37	3,29	1,98	2,29	2,69	3,67	3,52	2,81	4,45	3,90	5,50	3,16	6,65	2,61		
	8	0,57	8,00	1,01	4,50	1,57	2,88	2,26	2,00	3,08	3,21	4,02	2,46	5,09	3,41	6,28	2,76	7,60	2,28		
Number of cooling channels		2,2		2,3		2,4		2,5		2,6		2,7		2,8		2,9		3,0			
		A <sub>out</sub> [mm <sup>2</sup> ]	MQL ratio	A <sub>out</sub> [mm <sup>2</sup> ]	MQL ratio	A <sub>out</sub> [mm <sup>2</sup> ]	MQL ratio	A <sub>out</sub> [mm <sup>2</sup> ]	MQL ratio	A <sub>out</sub> [mm <sup>2</sup> ]	MQL ratio	A <sub>out</sub> [mm <sup>2</sup> ]	MQL ratio	A <sub>out</sub> [mm <sup>2</sup> ]	MQL ratio	A <sub>out</sub> [mm <sup>2</sup> ]	MQL ratio	A <sub>out</sub> [mm <sup>2</sup> ]	MQL ratio	A <sub>out</sub> [mm <sup>2</sup> ]	MQL ratio
	1	3,80	2,60	4,15	2,38	4,52	3,84	4,91	3,53	5,31	3,27	5,73	3,03	6,16	2,82	6,61	2,63	7,07	2,45		
	2	7,60	2,28	8,31	2,09	9,05	1,92	9,82	1,77	10,62	1,63	11,45	1,52	12,32	1,41	13,21	1,31	14,14	1,23		
	3	11,40	1,52	12,46	1,39	13,57	1,28	14,73	1,18	15,93	1,09	17,18	1,01	18,47	0,94	19,82	0,88	21,21			
	4	15,21	1,14	16,62	1,04	18,10	0,96	19,63	0,88	21,24		22,90		24,63		26,42		28,27			
	5	19,01	0,91	20,77		22,62		24,54		26,55		28,63		30,79		33,03		35,34			
	6	22,81		24,93		27,14		29,45		31,86		34,35		36,95		39,63		42,41			
7	26,61		29,08		31,67		34,36		37,17		40,08		43,10		46,24		49,48				
8	30,41		33,24		36,19		39,27		42,47		45,80		49,26		52,84		56,55				

Permissible with limitations

	1,2		1,3		1,4		1,5		1,6		1,7		1,8		1,9		2,0		2,1	
	A <sub>out</sub> [mm <sup>2</sup> ]	MQL ratio	A <sub>out</sub> [mm <sup>2</sup> ]	MQL ratio	A <sub>out</sub> [mm <sup>2</sup> ]	MQL ratio	A <sub>out</sub> [mm <sup>2</sup> ]	MQL ratio	A <sub>out</sub> [mm <sup>2</sup> ]	MQL ratio	A <sub>out</sub> [mm <sup>2</sup> ]	MQL ratio	A <sub>out</sub> [mm <sup>2</sup> ]	MQL ratio	A <sub>out</sub> [mm <sup>2</sup> ]	MQL ratio	A <sub>out</sub> [mm <sup>2</sup> ]	MQL ratio	A <sub>out</sub> [mm <sup>2</sup> ]	MQL ratio
	1,13	4,00	1,33	3,41	1,54	2,94	1,77	2,56	2,01	2,25	2,27	1,99	2,54	3,89	2,84	3,49	3,14	3,15	3,46	2,86
	2,26	2,00	2,65	3,73	3,08	3,21	3,53	2,80	4,02	2,46	4,54	3,82	5,09	3,41	5,67	3,06	6,28	2,76	6,93	2,50
	3,39	2,92	3,98	2,49	4,62	3,76	5,30	3,27	6,03	2,88	6,81	2,55	7,63	2,27	8,51	2,04	9,42	1,84	10,39	1,67
	4,52	3,84	5,31	3,27	6,16	2,82	7,07	2,45	8,04	2,16	9,08	1,91	10,18	1,70	11,34	1,53	12,57	1,38	13,85	1,25
	5,65	3,07	6,64	2,61	7,70	2,25	8,84	1,96	10,05	1,73	11,35	1,53	12,72	1,36	14,18	1,22	15,71	1,10	17,32	1,00
	6,79	2,56	7,96	2,18	9,24	1,88	10,60	1,64	12,06	1,44	13,62	1,27	15,27	1,14	17,01	1,02	18,85		20,78	
	7,92	2,19	9,29	1,87	10,78	1,61	12,37	1,40	14,07	1,23	15,89	1,09	17,81		19,85		21,99		24,25	
	9,05	1,92	10,62	1,63	12,32	1,41	14,14	1,23	16,08	1,08	18,16		20,36		22,68		25,13		27,71	
	3,1		3,2		3,3		3,4		3,5		3,6		3,7		3,8		3,9		4,0	
	A <sub>out</sub> [mm <sup>2</sup> ]	MQL ratio	A <sub>out</sub> [mm <sup>2</sup> ]	MQL ratio	A <sub>out</sub> [mm <sup>2</sup> ]	MQL ratio	A <sub>out</sub> [mm <sup>2</sup> ]	MQL ratio	A <sub>out</sub> [mm <sup>2</sup> ]	MQL ratio	A <sub>out</sub> [mm <sup>2</sup> ]	MQL ratio	A <sub>out</sub> [mm <sup>2</sup> ]	MQL ratio	A <sub>out</sub> [mm <sup>2</sup> ]	MQL ratio	A <sub>out</sub> [mm <sup>2</sup> ]	MQL ratio	A <sub>out</sub> [mm <sup>2</sup> ]	MQL ratio
	7,55	2,30	8,04	2,16	8,55	2,03	9,08	1,91	9,62	1,80	10,18	1,70	10,75	1,61	11,34	1,53	11,95	1,45	12,57	1,38
	15,10	1,15	16,08	1,08	17,11	1,01	18,16	0,96	19,24	0,90	20,36	0,85	21,50		22,68		23,89		25,13	
	22,64		24,13		25,66		27,24		28,86		30,54		32,26		34,02		35,84		37,70	
	30,19		32,17		34,21		36,32		38,48		40,72		43,01		45,36		47,78		50,27	
	37,74		40,21		42,76		45,40		48,11		50,89		53,76		56,71		59,73		62,83	
	45,29		48,25		51,32		54,48		57,73		61,07		64,51		68,05		71,68		75,40	
	52,83		56,30		59,87		63,55		67,35		71,25		75,26		79,39		83,62		87,96	
	60,38		64,34		68,42		72,63		76,97		81,43		86,02		90,73		95,57		100,53	



Taking into account the MQL ratio to be maintained for the 2-channel system, the tool is not suitable for MQL. It is imperative the tool is changed.

# 1-channel system MQL hydraulic chucks HydroChuck

For automatic tool change, with axial tool length adjustment  
 HSK-A (hollow shank taper form A) shank according to DIN 69893-1

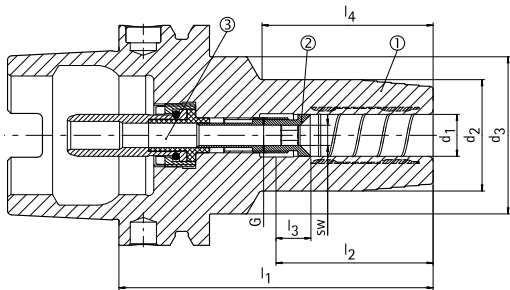

- ① Hydraulic chucks, HSK, MQL, tool body material | BDY
- ② Length adjustment screw, MQL | LS
- ③ Coolant supply unit, MQL, automatic | CU



## Preferred series available from stock

HSK-A	Dimensions							G	AF	Components			Specification	Order no.
	d <sub>1</sub>	d <sub>2</sub>	d <sub>3</sub>	l <sub>1</sub>	l <sub>2</sub>	l <sub>3</sub>	l <sub>4</sub>			BDY	LS	CU		
63	6	26	45	80	36	10	37	M10x1	4	30386549	30383941	10083281	MHC-HSK-A063-06-080-A-0-A-AAA	30386375
63	6	26	38	120	36	10	78	M5	2	30464609	30383945	10083281	MHC-HSK-A063-06-120-A-0-A-AAA	30470602
63	8	28	45	80	36	10	37,5	M10x1	4	30386550	10083384	10083281	MHC-HSK-A063-08-080-A-0-A-AAA	30386376
63	8	28	38	120	36	10	78,5	M7	3	30464610	10083394	10083281	MHC-HSK-A063-08-120-A-0-A-AAA	30470603
63	10	30	45	85	40	10	43,5	M10x1	4	30386551	10083385	10083281	MHC-HSK-A063-10-085-A-0-A-AAA	30386377
63	10	30	40	120	40	10	79	M8x1	4	30464611	10083401	10083281	MHC-HSK-A063-10-120-A-0-A-AAA	30470604
63	12	32	45	90	45	10	49	M10x1	5	30386552	10083386	10083281	MHC-HSK-A063-12-090-A-0-A-AAA	30386378
63	12	32	40	120	45	10	80,5	M10x1	5	30464612	10083409	10083281	MHC-HSK-A063-12-120-A-0-A-AAA	30470605
63	14	34	45	90	45	10	49,5	M10x1	5	30386553	10083387	10083281	MHC-HSK-A063-14-090-A-0-A-AAA	30386379
63	14	34	40	120	45	10	81	M10x1	5	30464613	10083410	10083281	MHC-HSK-A063-14-120-A-0-A-AAA	30470606
63	16	38	45	95	48	10	55,5	M12x1	5	30386554	10083388	10083281	MHC-HSK-A063-16-095-A-0-A-AAA	30386380
63	16	38	-	120	48	10	91,1	M12x1	5	30464614	10083411	10083281	MHC-HSK-A063-16-120-A-0-A-AAA	30470607
63	18	40	45	95	48	10	56	M12x1	5	30386555	10083389	10083281	MHC-HSK-A063-18-095-A-0-A-AAA	30386381
63	18	40	-	120	48	10	89,1	M12x1	5	30464615	10083412	10083281	MHC-HSK-A063-18-120-A-0-A-AAA	30470608
63	20	42	50	100	50	10	60,5	M16x1	5	30386556	10083390	10083281	MHC-HSK-A063-20-100-A-0-A-AAA	30386382
63	20	42	-	120	50	10	89,1	M16x1	5	30464616	10083413	10083281	MHC-HSK-A063-20-120-A-0-A-AAA	30470609
63	25	57	-	115	56	10	89	M16x1	5	30386557	10083391	10083281	MHC-HSK-A063-25-115-A-0-A-AAA	30386383
63	32	63	-	120	60	10	94	M16x1	5	30386558	10083392	10083281	MHC-HSK-A063-32-120-A-0-A-AAA	30386384
100	6	26	45	85	36	10	36,5	M10x1	4	30386569	30383941	10083283	MHC-HSK-A100-06-085-A-0-A-AAA	30386415
100	8	28	45	85	36	10	37	M10x1	4	30386570	10083384	10083283	MHC-HSK-A100-08-085-A-0-A-AAA	30386416
100	10	30	45	90	40	10	43	M10x1	4	30386571	10083385	10083283	MHC-HSK-A100-10-090-A-0-A-AAA	30386417
100	12	32	45	95	45	10	48,5	M10x1	5	30386572	10083386	10083283	MHC-HSK-A100-12-095-A-0-A-AAA	30386418
100	14	34	45	95	45	10	49	M10x1	5	30386573	10083387	10083283	MHC-HSK-A100-14-095-A-0-A-AAA	30386419
100	16	38	45	100	48	10	55	M12x1	5	30386574	10083388	10083283	MHC-HSK-A100-16-100-A-0-A-AAA	30386420
100	18	40	45	100	48	10	55,5	M12x1	5	30386575	10083389	10083283	MHC-HSK-A100-18-100-A-0-A-AAA	30386421
100	20	42	50	105	50	10	60	M16x1	5	30386576	10083390	10083283	MHC-HSK-A100-20-105-A-0-A-AAA	30386422
100	25	57	-	115	56	10	86	M16x1	5	30386577	10083391	10083283	MHC-HSK-A100-25-115-A-0-A-AAA	30386423
100	32	63	-	120	60	10	91	M16x1	5	30386578	10083392	10083283	MHC-HSK-A100-32-120-A-0-A-AAA	30386424

Dimensions in mm.

Use: To clamp tools with smooth cylindrical shanks according to DIN 1835 form A, DIN 6535 form HA as well as with recesses according to DIN 1835 form B, E and DIN 6535 form HB, HE directly and without reducing sleeve in the clamping diameter. The clamping diameter is designed for a shank tolerance of h6.

Scope of delivery: Tool body, length adjustment screw and coolant unit as assembly. These components can also be ordered separately (see table).

Design: Highest tool life and production quality when using smooth cylindrical shanks according to DIN 1835 form A and DIN 6535 form HA. With a projection length of 2.5xD (max. 50 mm) radial run-out accuracy 3 µm. When using cylindrical shanks with an inclined clamping surface (form E and form HE), the accuracy may be impaired. Different versions with chip available on request.

Balancing quality: G 2.5 with 25,000 rpm in delivery status.

# 1-channel system MQL hydraulic chucks HydroChuck

For automatic tool change, with axial tool length adjustment  
 HSK-A (hollow shank taper form A) shank according to DIN 69893-1

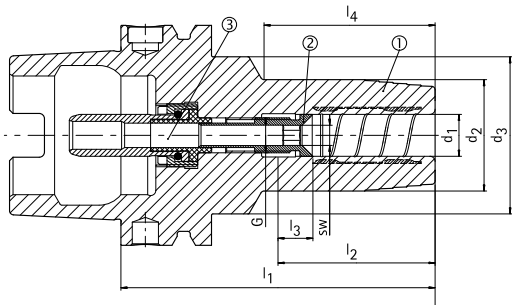

- ① Hydraulic chucks, HSK, MQL, tool body material | BDY
- ② Length adjustment screw, MQL | LS
- ③ Coolant supply unit, MQL, automatic | CU



**Available on request**

HSK-A	Dimensions							G	AF	Components			Specification	Order no.
	d <sub>1</sub>	d <sub>2</sub>	d <sub>3</sub>	l <sub>1</sub>	l <sub>2</sub>	l <sub>3</sub>	l <sub>4</sub>			BDY	LS	CU		
40	6	26	33,5	80	36	10	49	M7	3	30386529	10083370	10083279	MHC-HSK-A040-06-080-A-0-A-AAA	30386347
40	6	26	33,5	120	36	10	86	M5	2	30464569	30383945	10083279	MHC-HSK-A040-06-120-A-0-A-AAA	30470545
40	6	26	33,5	160	36	10	118	M5	2	30464575	30383945	10083279	MHC-HSK-A040-06-160-A-0-A-AAA	30470551
40	8	28	33,5	80	36	10	50,5	M7	3	30386530	10083371	10083279	MHC-HSK-A040-08-080-A-0-A-AAA	30386348
40	8	28	33,5	120	36	10	86,5	M7	3	30464570	10083394	10083279	MHC-HSK-A040-08-120-A-0-A-AAA	30470546
40	8	28	33,5	160	36	10	118	M7	3	30464576	10083394	10083279	MHC-HSK-A040-08-160-A-0-A-AAA	30470552
40	10	30	33,5	80	40	10	52	M8x1	3	30386531	10083372	10083279	MHC-HSK-A040-10-080-A-0-A-AAA	30386349
40	10	30	33,5	120	40	10	87	M8x1	3	30464571	10083395	10083279	MHC-HSK-A040-10-120-A-0-A-AAA	30470547
40	10	30	33,5	160	40	10	127	M8x1	3	30464577	10083395	10083279	MHC-HSK-A040-10-160-A-0-A-AAA	30470553
40	12	32	33,5	90	45	10	62	M10x1	3	30386532	10083373	10083279	MHC-HSK-A040-12-090-A-0-A-AAA	30386350
40	12	32	33,5	120	45	10	91,5	M10x1	3	30464572	10083396	10083279	MHC-HSK-A040-12-120-A-0-A-AAA	30470548
40	12	32	33,5	160	45	10	126	M10x1	3	30464578	10083396	10083279	MHC-HSK-A040-12-160-A-0-A-AAA	30470554
40	14	34	45	90	45	10	39,5	M10x1	3	30386533	10083374	10083279	MHC-HSK-A040-14-090-A-0-A-AAA	30386351
40	14	34	-	120	45	10	100	M10x1	3	30464573	10083397	10083279	MHC-HSK-A040-14-120-A-0-A-AAA	30470549
40	14	34	-	160	45	10	140	M10x1	3	30464579	10083397	10083279	MHC-HSK-A040-14-160-A-0-A-AAA	30470555
40	16	38	50	90	48	10	39	M12x1	3	30386534	10083375	10083279	MHC-HSK-A040-16-090-A-0-A-AAA	30386352
40	16	38	-	120	48	10	100	M12x1	3	30464574	10083398	10083279	MHC-HSK-A040-16-120-A-0-A-AAA	30470550
40	16	38	-	160	48	10	140	M12x1	3	30464580	10083398	10083279	MHC-HSK-A040-16-160-A-0-A-AAA	30470556
50	6	26	40	80	36	10	38,5	M8x1	4	30386541	10083376	10083280	MHC-HSK-A050-06-080-A-0-A-AAA	30386359
50	6	26	35	120	36	10	80	M5	2	30464593	30383945	10083280	MHC-HSK-A050-06-120-A-0-A-AAA	30470569
50	6	26	35	160	36	10	118	M5	2	30464601	30383945	10083280	MHC-HSK-A050-06-160-A-0-A-AAA	30470578
50	8	28	40	80	36	10	39	M8x1	4	30386542	10083377	10083280	MHC-HSK-A050-08-080-A-0-A-AAA	30386360
50	8	28	35	120	36	10	80	M7	3	30464594	10083394	10083280	MHC-HSK-A050-08-120-A-0-A-AAA	30470570
50	8	28	35	160	36	10	118	M7	3	30464602	10083394	10083280	MHC-HSK-A050-08-160-A-0-A-AAA	30470579
50	10	30	40	85	40	10	44,5	M8x1	4	30386543	10083378	10083280	MHC-HSK-A050-10-085-A-0-A-AAA	30386361
50	10	30	38	120	40	10	80	M8x1	4	30464595	10083401	10083280	MHC-HSK-A050-10-120-A-0-A-AAA	30470571
50	10	30	38	160	40	10	120	M8x1	4	30464603	10083401	10083280	MHC-HSK-A050-10-160-A-0-A-AAA	30470580
50	12	32	40	90	45	10	53	M10x1	4	30386544	10083379	10083280	MHC-HSK-A050-12-090-A-0-A-AAA	30386362
50	12	32	38	120	45	10	81	M10x1	4	30464596	10083402	10083280	MHC-HSK-A050-12-120-A-0-A-AAA	30470572
50	12	32	38	160	45	10	121	M10x1	4	30464604	10083402	10083280	MHC-HSK-A050-12-160-A-0-A-AAA	30470581
50	14	34	40	90	45	10	54,5	M10x1	4	30386545	10083380	10083280	MHC-HSK-A050-14-090-A-0-A-AAA	30386363
50	14	34	38	120	45	10	81,5	M10x1	4	30464597	10083403	10083280	MHC-HSK-A050-14-120-A-0-A-AAA	30470574
50	14	34	38	160	45	10	121,5	M10x1	4	30464605	10083403	10083280	MHC-HSK-A050-14-160-A-0-A-AAA	30470582
50	16	38	41,5	95	48	10	61	M12x1	4	30386546	10083381	10083280	MHC-HSK-A050-16-095-A-0-A-AAA	30386364
50	16	38	-	120	48	10	94	M12x1	4	30464598	10083404	10083280	MHC-HSK-A050-16-120-A-0-A-AAA	30470575
50	16	38	-	160	48	10	134	M12x1	4	30464606	10083404	10083280	MHC-HSK-A050-16-160-A-0-A-AAA	30470583
50	18	40	41,5	95	48	10	62,5	M12x1	4	30386547	10083382	10083280	MHC-HSK-A050-18-095-A-0-A-AAA	30386365
50	18	40	-	120	48	10	94	M12x1	4	30464599	10083405	10083280	MHC-HSK-A050-18-120-A-0-A-AAA	30470576
50	18	40	-	160	48	10	134	M12x1	4	30464607	10083405	10083280	MHC-HSK-A050-18-160-A-0-A-AAA	30470584
50	20	42	55	100	50	10	42	M16x1	4	30386548	10083383	10083280	MHC-HSK-A050-20-100-A-0-A-AAA	30386366
50	20	42	-	120	50	10	94	M16x1	4	30464600	10083406	10083280	MHC-HSK-A050-20-120-A-0-A-AAA	30470577
50	20	42	-	160	50	10	134	M16x1	4	30464608	10083406	10083280	MHC-HSK-A050-20-160-A-0-A-AAA	30470585

## 1-channel system MQL hydraulic chuck HydroChuck | Available on request

HSK-A	Dimensions							G	AF	Components			Specification	Order no.
	d <sub>1</sub>	d <sub>2</sub>	d <sub>3</sub>	l <sub>1</sub>	l <sub>2</sub>	l <sub>3</sub>	l <sub>4</sub>			BDY	LS	CU		
63	6	26	38	160	36	10	118	M5	2	30464617	30383945	10083281	MHC-HSK-A063-06-160-A-0-A-AAA	30470610
63	6	30	38	200	36	10	155	M5	2	30464627	30383945	10083281	MHC-HSK-A063-06-200-A-0-A-AAA	30470620
63	8	28	38	160	36	10	118	M7	3	30464618	10083394	10083281	MHC-HSK-A063-08-160-A-0-A-AAA	30470611
63	8	32	38	200	36	10	156	M7	3	30464628	10083394	10083281	MHC-HSK-A063-08-200-A-0-A-AAA	30470621
63	10	30	40	160	40	10	115	M8x1	4	30464619	10083401	10083281	MHC-HSK-A063-10-160-A-0-A-AAA	30470612
63	10	31	40	200	40	10	155	M8x1	4	30464629	10083401	10083281	MHC-HSK-A063-10-200-A-0-A-AAA	30470622
63	12	32	40	160	45	10	121	M10x1	5	30464620	10083409	10083281	MHC-HSK-A063-12-160-A-0-A-AAA	30470613
63	12	32	40	200	45	10	161	M10x1	5	30464630	10083409	10083281	MHC-HSK-A063-12-200-A-0-A-AAA	30470623
63	14	34	40	160	45	10	121	M10x1	5	30464621	10083410	10083281	MHC-HSK-A063-14-160-A-0-A-AAA	30470614
63	14	34	40	200	45	10	161	M10x1	5	30464631	10083410	10083281	MHC-HSK-A063-14-200-A-0-A-AAA	30470624
63	16	38	-	160	48	10	131	M12x1	5	30464622	10083411	10083281	MHC-HSK-A063-16-160-A-0-A-AAA	30470615
63	16	38	-	200	48	10	171	M12x1	5	30464632	10083411	10083281	MHC-HSK-A063-16-200-A-0-A-AAA	30470625
63	18	40	-	160	48	10	129	M12x1	5	30464623	10083412	10083281	MHC-HSK-A063-18-160-A-0-A-AAA	30470616
63	18	40	-	200	48	10	169	M12x1	5	30464633	10083412	10083281	MHC-HSK-A063-18-200-A-0-A-AAA	30470626
63	20	42	-	160	50	10	129	M16x1	5	30464624	10083413	10083281	MHC-HSK-A063-20-160-A-0-A-AAA	30470617
63	20	42	-	200	50	10	169	M16x1	5	30464634	10083413	10083281	MHC-HSK-A063-20-200-A-0-A-AAA	30470627
63	25	57	-	160	56	10	134	M16x1	5	30464625	10083414	10083281	MHC-HSK-A063-25-160-A-0-A-AAA	30470618
63	25	57	-	200	56	10	174	M16x1	5	30464635	10083414	10083281	MHC-HSK-A063-25-200-A-0-A-AAA	30470628
63	32	63	-	160	60	10	134	M16x1	5	30464626	10083415	10083281	MHC-HSK-A063-32-160-A-0-A-AAA	30470619
63	32	63	-	200	60	10	174	M16x1	5	30464636	10083415	10083281	MHC-HSK-A063-32-200-A-0-A-AAA	30470629
100	6	26	38	120	36	10	73,5	M5	2	30464665	30383945	10083283	MHC-HSK-A100-06-120-A-0-A-AAA	30470714
100	6	26	38	160	36	10	113,5	M5	2	30464673	30383945	10083283	MHC-HSK-A100-06-160-A-0-A-AAA	30470722
100	6	30	38	200	36	10	155	M5	2	30464683	30383945	10083283	MHC-HSK-A100-06-200-A-0-A-AAA	30470732
100	8	28	38	120	36	10	74	M7	3	30464666	10083394	10083283	MHC-HSK-A100-08-120-A-0-A-AAA	30470715
100	8	28	38	160	36	10	114	M7	3	30464674	10083394	10083283	MHC-HSK-A100-08-160-A-0-A-AAA	30470723
100	8	32	38	200	36	10	155,5	M7	3	30464684	10083394	10083283	MHC-HSK-A100-08-200-A-0-A-AAA	30470733
100	10	30	40	120	40	10	74,5	M8x1	4	30464667	10083401	10083283	MHC-HSK-A100-10-120-A-0-A-AAA	30470716
100	10	30	40	160	40	10	114,5	M8x1	4	30464675	10083401	10083283	MHC-HSK-A100-10-160-A-0-A-AAA	30470724
100	10	31	40	200	40	10	155	M8x1	4	30464685	10083401	10083283	MHC-HSK-A100-10-200-A-0-A-AAA	30470734
100	12	32	40	120	45	10	75	M10x1	5	30464668	10083409	10083283	MHC-HSK-A100-12-120-A-0-A-AAA	30470717
100	12	32	40	160	45	10	115	M10x1	5	30464676	10083409	10083283	MHC-HSK-A100-12-160-A-0-A-AAA	30470725
100	12	32	40	200	45	10	155	M10x1	5	30464686	10083409	10083283	MHC-HSK-A100-12-200-A-0-A-AAA	30470735
100	14	34	40	120	45	10	75,5	M10x1	5	30464669	10083410	10083283	MHC-HSK-A100-14-120-A-0-A-AAA	30470718
100	14	34	40	160	45	10	115,5	M10x1	5	30464677	10083410	10083283	MHC-HSK-A100-14-160-A-0-A-AAA	30470726
100	14	34	40	200	45	10	155,5	M10x1	5	30464687	10083410	10083283	MHC-HSK-A100-14-200-A-0-A-AAA	30470736
100	16	38	-	120	48	10	81,1	M12x1	5	30464670	10083411	10083283	MHC-HSK-A100-16-120-A-0-A-AAA	30470719
100	16	38	-	160	48	10	121,1	M12x1	5	30464678	10083411	10083283	MHC-HSK-A100-16-160-A-0-A-AAA	30470727
100	16	38	-	200	48	10	161,1	M12x1	5	30464688	10083411	10083283	MHC-HSK-A100-16-200-A-0-A-AAA	30470737
100	18	40	-	120	48	10	81,1	M12x1	5	30464671	10083412	10083283	MHC-HSK-A100-18-120-A-0-A-AAA	30470720
100	18	40	-	160	48	10	121,1	M12x1	5	30464679	10083412	10083283	MHC-HSK-A100-18-160-A-0-A-AAA	30470728
100	18	40	-	200	48	10	161,1	M12x1	5	30464689	10083412	10083283	MHC-HSK-A100-18-200-A-0-A-AAA	30470738
100	20	42	-	120	50	10	81,1	M16x1	5	30464672	10083413	10083283	MHC-HSK-A100-20-120-A-0-A-AAA	30470721
100	20	42	-	160	50	10	121,1	M16x1	5	30464680	10083413	10083283	MHC-HSK-A100-20-160-A-0-A-AAA	30470729
100	20	42	-	200	50	10	161,1	M16x1	5	30464690	10083413	10083283	MHC-HSK-A100-20-200-A-0-A-AAA	30470739
100	25	57	-	160	56	10	131	M16x1	5	30464681	10083414	10083283	MHC-HSK-A100-25-160-A-0-A-AAA	30470730
100	25	57	-	200	56	10	171	M16x1	5	30464691	10083414	10083283	MHC-HSK-A100-25-200-A-0-A-AAA	30470740
100	32	63	-	160	60	10	131	M16x1	5	30464682	10083415	10083283	MHC-HSK-A100-32-160-A-0-A-AAA	30470731
100	32	63	-	200	60	10	171	M16x1	5	30464692	10083415	10083283	MHC-HSK-A100-32-200-A-0-A-AAA	30470741

Dimensions in mm.

Use: To clamp tools with smooth cylindrical shanks according to DIN 1835 form A, DIN 6535 form HA as well as with recesses according to DIN 1835 form B, E and DIN 6535 form HB, HE directly and without reducing sleeve in the clamping diameter. The clamping diameter is designed for a shank tolerance of h6.

Scope of delivery: Tool body, length adjustment screw and coolant unit as assembly. These components can also be ordered separately (see table).

Design: Highest tool life and production quality when using smooth cylindrical shanks according to DIN 1835 form A and DIN 6535 form HA. With a projection length of 2.5xD (max. 50 mm) radial run-out accuracy 3 µm. When using cylindrical shanks with an inclined clamping surface (form E and form HE), the accuracy may be impaired. Different versions with chip available on request.

Balancing quality: G 2.5 with 25,000 rpm in delivery state.



# 1-channel system MQL shrink chuck ThermoChuck

For automatic tool change, with axial tool length adjustment  
 HSK-A (hollow shank taper form A) shank according to DIN 69893-1

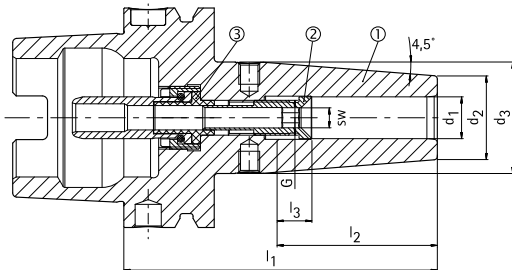

- ① Shrink chuck, HSK, MQL, tool body | BDY
- ② Length adjustment screw, MQL | LS
- ③ Coolant supply unit, MQL, automatic | CU



**Preferred series available from stock**

HSK-A	Dimensions						G	AF	Components			Specification	Order no.
	d <sub>1</sub>	d <sub>2</sub>	d <sub>3</sub>	l <sub>1</sub>	l <sub>2</sub>	l <sub>3</sub>			BDY	LS	CU		
63	6	21	27	80	36	10	M10x1	4	10083235	30383941	10083281	MTC-HSK-A063-06-080-A-0-A-AAA	30380921
63	6	21	27	120	36	10	M5	2	30386128	30383945	10083281	MTC-HSK-A063-06-120-A-0-A-AAA	30385484
63	8	21	27	80	36	10	M10x1	4	10083236	10083384	10083281	MTC-HSK-A063-08-080-A-0-A-AAA	30380922
63	8	21	27	120	36	10	M7	3	30386129	10083394	10083281	MTC-HSK-A063-08-120-A-0-A-AAA	30385485
63	10	24	32	85	40	10	M10x1	4	10083237	10083385	10083281	MTC-HSK-A063-10-085-A-0-A-AAA	30380923
63	10	24	32	120	40	10	M8x1	4	30386800	10083401	10083281	MTC-HSK-A063-10-120-A-0-A-AAA	30385486
63	12	24	32	90	45	10	M10x1	5	10083238	10083386	10083281	MTC-HSK-A063-12-090-A-0-A-AAA	30380924
63	12	24	32	120	45	10	M10x1	5	10096023	10083409	10083281	MTC-HSK-A063-12-120-A-0-A-AAA	30340561
63	14	27	34	90	45	10	M10x1	5	10083239	10083387	10083281	MTC-HSK-A063-14-090-A-0-A-AAA	30380925
63	14	27	34	120	45	10	M10x1	5	30192712	10083410	10083281	MTC-HSK-A063-14-120-A-0-A-AAA	30340562
63	16	27	34	95	48	10	M12x1	5	10083240	10083388	10083281	MTC-HSK-A063-16-095-A-0-A-AAA	30380926
63	16	27	34	120	48	10	M12x1	5	10107287	10083411	10083281	MTC-HSK-A063-16-120-A-0-A-AAA	30340563
63	18	33	42	95	48	10	M12x1	5	10083241	10083389	10083281	MTC-HSK-A063-18-095-A-0-A-AAA	30380927
63	18	33	42	120	48	10	M12x1	5	10107292	10083412	10083281	MTC-HSK-A063-18-120-A-0-A-AAA	30263986
63	20	33	42	100	50	10	M16x1	5	10083242	10083390	10083281	MTC-HSK-A063-20-100-A-0-A-AAA	30380928
63	20	33	42	120	50	10	M16x1	5	30192716	10083413	10083281	MTC-HSK-A063-20-120-A-0-A-AAA	30340564
63	25	44	53	115	56	10	M16x1	5	10083243	10083391	10083281	MTC-HSK-A063-25-115-A-0-A-AAA	30380929
63	32	44	53	120	60	10	M16x1	5	10083244	10083392	10083281	MTC-HSK-A063-32-120-A-0-A-AAA	30380930
100	6	21	27	85	36	10	M10x1	4	10083255	30383941	10083283	MTC-HSK-A100-06-085-A-0-A-AAA	30381074
100	8	21	27	85	36	10	M10x1	4	10083256	10083384	10083283	MTC-HSK-A100-08-085-A-0-A-AAA	30381075
100	10	24	32	90	40	10	M10x1	4	10083257	10083385	10083283	MTC-HSK-A100-10-090-A-0-A-AAA	30381076
100	12	24	32	95	45	10	M10x1	5	10083258	10083386	10083283	MTC-HSK-A100-12-095-A-0-A-AAA	30381077
100	14	27	34	95	45	10	M10x1	5	10083259	10083387	10083283	MTC-HSK-A100-14-095-A-0-A-AAA	30381078
100	16	27	34	100	48	10	M12x1	5	10083260	10083388	10083283	MTC-HSK-A100-16-100-A-0-A-AAA	30381079
100	18	33	42	100	48	10	M12x1	5	10083261	10083389	10083283	MTC-HSK-A100-18-100-A-0-A-AAA	30381080
100	20	33	42	105	50	10	M16x1	5	10083262	10083390	10083283	MTC-HSK-A100-20-105-A-0-A-AAA	30381081
100	25	44	53	115	56	10	M16x1	5	10083263	10083391	10083283	MTC-HSK-A100-25-115-A-0-A-AAA	30381082
100	32	44	53	120	60	10	M16x1	5	10083264	10083392	10083283	MTC-HSK-A100-32-120-A-0-A-AAA	30381083

Dimensions in mm.

Scope of delivery: Tool body, length adjustment screw and coolant unit as assembly. These components can also be ordered separately (see table).

Design: Permissible run-out variation of the hollow taper shank to the clamping diameter  $d_1 = 3 \mu\text{m}$ . The clamping diameter is designed for a shank tolerance of h6.

Different versions with chip available on request.

Balancing quality: G 2.5 with 25,000 rpm in delivery state.

# 1-channel system MQL shrink chuck ThermoChuck

For automatic tool change, with axial tool length adjustment  
 HSK-A (hollow shank taper form A) shank according to DIN 69893-1

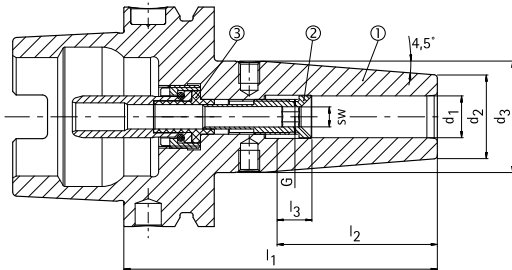

- ① Shrink chuck, HSK, MQL, tool body | BDY
- ② Length adjustment screw, MQL | LS
- ③ Coolant supply unit, MQL, automatic | CU



## Available on request

HSK-A	Dimensions						G	AF	Components			Specification	Order no.
	d <sub>1</sub>	d <sub>2</sub>	d <sub>3</sub>	l <sub>1</sub>	l <sub>2</sub>	l <sub>3</sub>			BDY	LS	CU		
40	6	21	27	80	36	10	M7	3	10083221	10083370	10083279	MTC-HSK-A040-06-080-A-0-A-AAA	30335292
40	8	21	27	80	36	10	M7	3	10083222	10083371	10083279	MTC-HSK-A040-08-080-A-0-A-AAA	30335293
40	10	24	32	80	40	10	M8x1	3	10083223	10083372	10083279	MTC-HSK-A040-10-080-A-0-A-AAA	30335294
40	12	24	32	90	45	10	M10x1	3	10083224	10083373	10083279	MTC-HSK-A040-12-090-A-0-A-AAA	30335295
40	14	27	34	90	45	10	M10x1	3	10083225	10083374	10083279	MTC-HSK-A040-14-090-A-0-A-AAA	30335296
40	16	27	34	90	48	10	M12x1	3	10083226	10083375	10083279	MTC-HSK-A040-16-090-A-0-A-AAA	30335297
50	6	21	27	80	36	10	M8x1	4	10083227	10083376	10083280	MTC-HSK-A050-06-080-A-0-A-AAA	30335328
50	8	21	27	80	36	10	M8x1	4	10083228	10083377	10083280	MTC-HSK-A050-08-080-A-0-A-AAA	30335329
50	10	24	32	85	40	10	M8x1	4	10083229	10083378	10083280	MTC-HSK-A050-10-085-A-0-A-AAA	30335330
50	12	24	32	90	45	10	M10x1	4	10083230	10083379	10083280	MTC-HSK-A050-12-090-A-0-A-AAA	30335331
50	14	27	34	90	45	10	M10x1	4	10083231	10083380	10083280	MTC-HSK-A050-14-090-A-0-A-AAA	30335332
50	16	27	34	95	48	10	M12x1	4	10083232	10083381	10083280	MTC-HSK-A050-16-095-A-0-A-AAA	30335333
50	18	33	42	95	48	10	M12x1	4	10083233	10083382	10083280	MTC-HSK-A050-18-095-A-0-A-AAA	30335334
50	20	33	42	100	50	10	M16x1	4	10083234	10083383	10083280	MTC-HSK-A050-20-100-A-0-A-AAA	30335335
63	6	21	27	160	36	10	M5	2	30386130	30383945	10083281	MTC-HSK-A063-06-160-A-0-A-AAA	30385490
63	6	21	27	200	36	10	M5	2	30386132	30383945	10083281	MTC-HSK-A063-06-200-A-0-A-AAA	30385496
63	8	21	27	160	36	10	M7	3	30386131	10083394	10083281	MTC-HSK-A063-08-160-A-0-A-AAA	30385491
63	8	21	27	200	36	10	M7	3	30386133	10083394	10083281	MTC-HSK-A063-08-200-A-0-A-AAA	30385497
63	10	24	32	160	40	10	M8x1	4	30386802	10083401	10083281	MTC-HSK-A063-10-160-A-0-A-AAA	30385492
63	10	24	32	200	40	10	M8x1	4	30386134	10083401	10083281	MTC-HSK-A063-10-200-A-0-A-AAA	30385498
63	12	24	32	160	45	10	M10x1	5	30197953	10083409	10083281	MTC-HSK-A063-12-160-A-0-A-AAA	30340566
63	12	24	32	200	45	10	M10x1	5	10107285	10083409	10083281	MTC-HSK-A063-12-200-A-0-A-AAA	30340573
63	14	27	34	160	45	10	M10x1	5	10096025	10083410	10083281	MTC-HSK-A063-14-160-A-0-A-AAA	30340567
63	14	27	34	200	45	10	M10x1	5	10096026	10083410	10083281	MTC-HSK-A063-14-200-A-0-A-AAA	30340574
63	16	27	34	160	48	10	M12x1	5	10107288	10083411	10083281	MTC-HSK-A063-16-160-A-0-A-AAA	30340568
63	16	27	34	200	48	10	M12x1	5	10107289	10083411	10083281	MTC-HSK-A063-16-200-A-0-A-AAA	30340575
63	18	33	42	160	48	10	M12x1	5	10096027	10083412	10083281	MTC-HSK-A063-18-160-A-0-A-AAA	30340570
63	18	33	42	200	48	10	M12x1	5	10107293	10083412	10083281	MTC-HSK-A063-18-200-A-0-A-AAA	30340576
63	20	33	42	160	50	10	M16x1	5	10107294	10083413	10083281	MTC-HSK-A063-20-160-A-0-A-AAA	30263987
63	20	33	42	200	50	10	M16x1	5	10107295	10083413	10083281	MTC-HSK-A063-20-200-A-0-A-AAA	30340577
63	25	44	53	160	56	10	M16x1	5	10107296	10083414	10083281	MTC-HSK-A063-25-160-A-0-A-AAA	30296689
63	25	44	53	200	56	10	M16x1	5	10107297	10083414	10083281	MTC-HSK-A063-25-200-A-0-A-AAA	30340578
63	32	44	53	160	60	10	M16x1	5	10107298	10083415	10083281	MTC-HSK-A063-32-160-A-0-A-AAA	30340571
63	32	44	53	200	60	10	M16x1	5	10107299	10083415	10083281	MTC-HSK-A063-32-200-A-0-A-AAA	30340579
80	6	21	27	85	36	10	M10x1	4	10083245	30383941	10083282	MTC-HSK-A080-06-085-A-0-A-AAA	30380997
80	8	21	27	85	36	10	M10x1	4	10083246	10083384	10083282	MTC-HSK-A080-08-085-A-0-A-AAA	30380998
80	10	24	32	90	40	10	M10x1	4	10083247	10083385	10083282	MTC-HSK-A080-10-090-A-0-A-AAA	30380999
80	12	24	32	95	45	10	M10x1	5	10083248	10083386	10083282	MTC-HSK-A080-12-095-A-0-A-AAA	30381000
80	14	27	34	95	45	10	M10x1	5	10083249	10083387	10083282	MTC-HSK-A080-14-095-A-0-A-AAA	30381001

1-channel system MQL shrink chuck ThermoChuck | Available on request

HSK-A	Dimensions						G	AF	Components			Specification	Order no.
	d <sub>1</sub>	d <sub>2</sub>	d <sub>3</sub>	l <sub>1</sub>	l <sub>2</sub>	l <sub>3</sub>			BDY	LS	CU		
80	16	27	34	100	48	10	M12x1	5	10083250	10083388	10083282	MTC-HSK-A080-16-100-A-0-A-AAA	30381002
80	18	33	42	100	48	10	M12x1	5	10083251	10083389	10083282	MTC-HSK-A080-18-100-A-0-A-AAA	30381003
80	20	33	42	105	50	10	M16x1	5	10083252	10083390	10083282	MTC-HSK-A080-20-105-A-0-A-AAA	30381004
80	25	44	53	115	56	10	M16x1	5	10083253	10083391	10083282	MTC-HSK-A080-25-115-A-0-A-AAA	30381005
80	32	44	53	120	60	10	M16x1	5	10083254	10083392	10083282	MTC-HSK-A080-32-120-A-0-A-AAA	30381006
100	6	21	27	120	36	10	M5	2	30386144	30383945	10083283	MTC-HSK-A100-06-120-A-0-A-AAA	30385520
100	6	21	27	160	36	10	M5	2	30386147	30383945	10083283	MTC-HSK-A100-06-160-A-0-A-AAA	30385526
100	6	21	27	200	36	10	M5	2	30386150	30383945	10083283	MTC-HSK-A100-06-200-A-0-A-AAA	30385532
100	8	21	27	120	36	10	M7	3	30386145	10083394	10083283	MTC-HSK-A100-08-120-A-0-A-AAA	30385521
100	8	21	27	160	36	10	M7	3	30386148	10083394	10083283	MTC-HSK-A100-08-160-A-0-A-AAA	30385527
100	8	21	27	200	36	10	M7	3	30386151	10083394	10083283	MTC-HSK-A100-08-200-A-0-A-AAA	30385533
100	10	24	32	120	40	10	M8x1	4	30386146	10083401	10083283	MTC-HSK-A100-10-120-A-0-A-AAA	30385522
100	10	24	32	160	40	10	M8x1	4	30386149	10083401	10083283	MTC-HSK-A100-10-160-A-0-A-AAA	30385528
100	10	24	32	200	40	10	M8x1	4	30386152	10083401	10083283	MTC-HSK-A100-10-200-A-0-A-AAA	30385534
100	12	24	32	120	45	10	M10x1	5	30253151	10083409	10083283	MTC-HSK-A100-12-120-A-0-A-AAA	30480187
100	12	24	32	160	45	10	M10x1	5	30302825	10083409	10083283	MTC-HSK-A100-12-160-A-0-A-AAA	30480198
100	12	24	32	200	45	10	M10x1	5	30253152	10083409	10083283	MTC-HSK-A100-12-200-A-0-A-AAA	30480212
100	14	27	34	120	45	10	M10x1	5	30254306	10083410	10083283	MTC-HSK-A100-14-120-A-0-A-AAA	30480188
100	14	27	34	160	45	10	M10x1	5	30302826	10083410	10083283	MTC-HSK-A100-14-160-A-0-A-AAA	30480199
100	14	27	34	200	45	10	M10x1	5	30303050	10083410	10083283	MTC-HSK-A100-14-200-A-0-A-AAA	30480213
100	16	27	34	120	48	10	M12x1	5	30302821	10083411	10083283	MTC-HSK-A100-16-120-A-0-A-AAA	30480189
100	16	27	34	160	48	10	M12x1	5	30302827	10083411	10083283	MTC-HSK-A100-16-160-A-0-A-AAA	30480200
100	16	27	34	200	48	10	M12x1	5	30302831	10083411	10083283	MTC-HSK-A100-16-200-A-0-A-AAA	30480214
100	18	33	42	120	48	10	M12x1	5	30253155	10083412	10083283	MTC-HSK-A100-18-120-A-0-A-AAA	30480190
100	18	33	42	160	48	10	M12x1	5	10096879	10083412	10083283	MTC-HSK-A100-18-160-A-0-A-AAA	30480201
100	18	33	42	200	48	10	M12x1	5	10107134	10083412	10083283	MTC-HSK-A100-18-200-A-0-A-AAA	30480215
100	20	33	42	120	50	10	M16x1	5	30302822	10083413	10083283	MTC-HSK-A100-20-120-A-0-A-AAA	30480192
100	20	33	42	160	50	10	M16x1	5	10096880	10083413	10083283	MTC-HSK-A100-20-160-A-0-A-AAA	30480202
100	20	33	42	200	50	10	M16x1	5	30302832	10083413	10083283	MTC-HSK-A100-20-200-A-0-A-AAA	30480216
100	25	44	53	160	56	10	M16x1	5	30258455	10083414	10083283	MTC-HSK-A100-25-160-A-0-A-AAA	30480203
100	25	44	53	200	56	10	M16x1	5	30302833	10083414	10083283	MTC-HSK-A100-25-200-A-0-A-AAA	30480217
100	32	44	53	160	60	10	M16x1	5	30303048	10083415	10083283	MTC-HSK-A100-32-160-A-0-A-AAA	30480204
100	32	44	53	200	60	10	M16x1	5	30302834	10083415	10083283	MTC-HSK-A100-32-200-A-0-A-AAA	30480218

Dimensions in mm.

Scope of delivery: Tool body, length adjustment screw and coolant unit as assembly. These components can also be ordered separately (see table).

Design: Permissible run-out variation of the hollow taper shank in relation to the clamping diameter d<sub>1</sub> = 3 µm. The clamping diameter is designed for a shank tolerance of h6.

Different versions with chip available on request.

Balancing quality: G 2.5 with 25,000 rpm in delivery state.

# 1-channel system MQL hydraulic chucks HydroChuck

For manual tool change, with axial tool length adjustment  
 HSK-A (hollow shank taper form A) shank according to DIN 69893-1

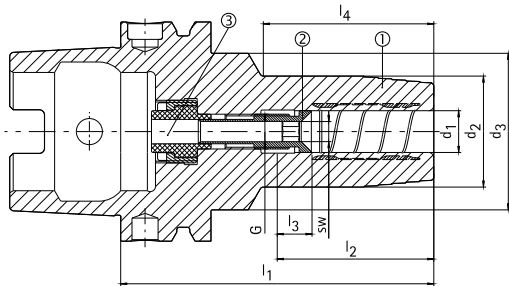

- ① Hydraulic chucks, HSK, MQL, tool body material | BDY
- ② Length adjustment screw, MQL | LS
- ③ Coolant supply unit, MQL, manual | CU



## Available on request

HSK-A	Dimensions							G	AF	Components			Specification	Order no.
	d <sub>1</sub>	d <sub>2</sub>	d <sub>3</sub>	l <sub>1</sub>	l <sub>2</sub>	l <sub>3</sub>	l <sub>4</sub>			BDY	LS	CU		
40	6	26	33,5	80	36	10	49	M7	3	30386529	10083370	10083268	MHC-HSK-A040-06-080-B-0-A-AAA	30386439
40	6	26	33,5	120	36	10	86	M5	2	30464569	30383945	10083268	MHC-HSK-A040-06-120-B-0-A-AAA	30470779
40	6	26	33,5	160	36	10	118	M5	2	30464575	30383945	10083268	MHC-HSK-A040-06-160-B-0-A-AAA	30470785
40	8	28	33,5	80	36	10	50,5	M7	3	30386530	10083371	10083268	MHC-HSK-A040-08-080-B-0-A-AAA	30386440
40	8	28	33,5	120	36	10	86,5	M7	3	30464570	10083394	10083268	MHC-HSK-A040-08-120-B-0-A-AAA	30470780
40	8	28	33,5	160	36	10	118	M7	3	30464576	10083394	10083268	MHC-HSK-A040-08-160-B-0-A-AAA	30470786
40	10	30	33,5	80	40	10	52	M8x1	3	30386531	10083372	10083268	MHC-HSK-A040-10-080-B-0-A-AAA	30386441
40	10	30	33,5	120	40	10	87	M8x1	3	30464571	10083395	10083268	MHC-HSK-A040-10-120-B-0-A-AAA	30470781
40	10	30	33,5	160	40	10	127	M8x1	3	30464577	10083395	10083268	MHC-HSK-A040-10-160-B-0-A-AAA	30470787
40	12	32	33,5	90	45	10	62	M10x1	3	30386532	10083373	10083268	MHC-HSK-A040-12-090-B-0-A-AAA	30386442
40	12	32	33,5	120	45	10	91,5	M10x1	3	30464572	10083396	10083268	MHC-HSK-A040-12-120-B-0-A-AAA	30470782
40	12	32	33,5	160	45	10	126	M10x1	3	30464578	10083396	10083268	MHC-HSK-A040-12-160-B-0-A-AAA	30470788
40	14	34	45	90	45	10	39,5	M10x1	3	30386533	10083374	10083268	MHC-HSK-A040-14-090-B-0-A-AAA	30386443
40	14	34	-	120	45	10	100	M10x1	3	30464573	10083397	10083268	MHC-HSK-A040-14-120-B-0-A-AAA	30470783
40	14	34	-	160	45	10	140	M10x1	3	30464579	10083397	10083268	MHC-HSK-A040-14-160-B-0-A-AAA	30470789
40	16	38	50	90	48	10	39	M12x1	3	30386534	10083375	10083268	MHC-HSK-A040-16-090-B-0-A-AAA	30386444
40	16	38	-	120	48	10	100	M12x1	3	30464574	10083398	10083268	MHC-HSK-A040-16-120-B-0-A-AAA	30470784
40	16	38	-	160	48	10	140	M12x1	3	30464580	10083398	10083268	MHC-HSK-A040-16-160-B-0-A-AAA	30470790
50	6	26	40	80	36	10	38,5	M8x1	4	30386541	10083376	10083269	MHC-HSK-A050-06-080-B-0-A-AAA	30386445
50	6	26	35	120	36	10	80	M5	2	30464593	30383945	10083269	MHC-HSK-A050-06-120-B-0-A-AAA	30470791
50	6	26	35	160	36	10	118	M5	2	30464601	30383945	10083269	MHC-HSK-A050-06-160-B-0-A-AAA	30470799
50	8	28	40	80	36	10	39	M8x1	4	30386542	10083377	10083269	MHC-HSK-A050-08-080-B-0-A-AAA	30386446
50	8	28	35	120	36	10	80	M7	3	30464594	10083394	10083269	MHC-HSK-A050-08-120-B-0-A-AAA	30470792
50	8	28	35	160	36	10	118	M7	3	30464602	10083394	10083269	MHC-HSK-A050-08-160-B-0-A-AAA	30470800
50	10	30	40	85	40	10	44,5	M8x1	4	30386543	10083378	10083269	MHC-HSK-A050-10-085-B-0-A-AAA	30386447
50	10	30	38	120	40	10	80	M8x1	4	30464595	10083401	10083269	MHC-HSK-A050-10-120-B-0-A-AAA	30470793
50	10	30	38	160	40	10	120	M8x1	4	30464603	10083401	10083269	MHC-HSK-A050-10-160-B-0-A-AAA	30470801
50	12	32	40	90	45	10	53	M10x1	4	30386544	10083379	10083269	MHC-HSK-A050-12-090-B-0-A-AAA	30386448
50	12	32	38	120	45	10	81	M10x1	4	30464596	10083402	10083269	MHC-HSK-A050-12-120-B-0-A-AAA	30470794
50	12	32	38	160	45	10	121	M10x1	4	30464604	10083402	10083269	MHC-HSK-A050-12-160-B-0-A-AAA	30470802
50	14	34	40	90	45	10	54,5	M10x1	4	30386545	10083380	10083269	MHC-HSK-A050-14-090-B-0-A-AAA	30386449
50	14	34	38	120	45	10	81,5	M10x1	4	30464597	10083403	10083269	MHC-HSK-A050-14-120-B-0-A-AAA	30470795
50	14	34	38	160	45	10	121,5	M10x1	4	30464605	10083403	10083269	MHC-HSK-A050-14-160-B-0-A-AAA	30470803
50	16	38	41,5	95	48	10	61	M12x1	4	30386546	10083381	10083269	MHC-HSK-A050-16-095-B-0-A-AAA	30386450
50	16	38	-	120	48	10	94	M12x1	4	30464598	10083404	10083269	MHC-HSK-A050-16-120-B-0-A-AAA	30470796
50	16	38	-	160	48	10	134	M12x1	4	30464606	10083404	10083269	MHC-HSK-A050-16-160-B-0-A-AAA	30470804
50	18	40	41,5	95	48	10	62,5	M12x1	4	30386547	10083382	10083269	MHC-HSK-A050-18-095-B-0-A-AAA	30386451
50	18	40	-	120	48	10	94	M12x1	4	30464599	10083405	10083269	MHC-HSK-A050-18-120-B-0-A-AAA	30470797
50	18	40	-	160	48	10	134	M12x1	4	30464607	10083405	10083269	MHC-HSK-A050-18-160-B-0-A-AAA	30470805

**1-channel system MQL hydraulic chuck HydroChuck | Available on request**

HSK-A	Dimensions							G	AF	Components			Specification	Order no.
	d <sub>1</sub>	d <sub>2</sub>	d <sub>3</sub>	l <sub>1</sub>	l <sub>2</sub>	l <sub>3</sub>	l <sub>4</sub>			BDY	LS	CU		
50	20	42	55	100	50	10	42	M16x1	4	30386548	10083383	10083269	MHC-HSK-A050-20-100-B-0-A-AAA	30386452
50	20	42	-	120	50	10	94	M16x1	4	30464600	10083406	10083269	MHC-HSK-A050-20-120-B-0-A-AAA	30470798
50	20	42	-	160	50	10	134	M16x1	4	30464608	10083406	10083269	MHC-HSK-A050-20-160-B-0-A-AAA	30470806
63	6	26	45	80	36	10	37	M10x1	4	30386549	30383941	10083270	MHC-HSK-A063-06-080-B-0-A-AAA	30386453
63	6	26	38	120	36	10	78	M5	2	30464609	30383945	10083270	MHC-HSK-A063-06-120-B-0-A-AAA	30470808
63	6	26	38	160	36	10	118	M5	2	30464617	30383945	10083270	MHC-HSK-A063-06-160-B-0-A-AAA	30470816
63	6	30	38	200	36	10	155	M5	2	30464627	30383945	10083270	MHC-HSK-A063-06-200-B-0-A-AAA	30470826
63	8	28	45	80	36	10	38	M10x1	4	30386550	10083384	10083270	MHC-HSK-A063-08-080-B-0-A-AAA	30386454
63	8	28	38	120	36	10	79	M7	3	30464610	10083394	10083270	MHC-HSK-A063-08-120-B-0-A-AAA	30470809
63	8	28	38	160	36	10	118	M7	3	30464618	10083394	10083270	MHC-HSK-A063-08-160-B-0-A-AAA	30470817
63	8	32	38	200	36	10	156	M7	3	30464628	10083394	10083270	MHC-HSK-A063-08-200-B-0-A-AAA	30470827
63	10	30	45	85	40	10	44	M10x1	4	30386551	10083385	10083270	MHC-HSK-A063-10-085-B-0-A-AAA	30386455
63	10	30	40	120	40	10	79	M8x1	4	30464611	10083401	10083270	MHC-HSK-A063-10-120-B-0-A-AAA	30470810
63	10	30	40	160	40	10	115	M8x1	4	30464619	10083401	10083270	MHC-HSK-A063-10-160-B-0-A-AAA	30470818
63	10	31	40	200	40	10	155	M8x1	4	30464629	10083401	10083270	MHC-HSK-A063-10-200-B-0-A-AAA	30470828
63	12	32	45	90	45	10	49	M10x1	5	30386552	10083386	10083270	MHC-HSK-A063-12-090-B-0-A-AAA	30386456
63	12	32	40	120	45	10	51	M10x1	5	30464612	10083409	10083270	MHC-HSK-A063-12-120-B-0-A-AAA	30470811
63	12	32	40	160	45	10	121	M10x1	5	30464620	10083409	10083270	MHC-HSK-A063-12-160-B-0-A-AAA	30470819
63	12	32	40	200	45	10	161	M10x1	5	30464630	10083409	10083270	MHC-HSK-A063-12-200-B-0-A-AAA	30470829
63	14	34	45	90	45	10	50	M10x1	5	30386553	10083387	10083270	MHC-HSK-A063-14-090-B-0-A-AAA	30386457
63	14	34	40	120	45	10	81	M10x1	5	30464613	10083410	10083270	MHC-HSK-A063-14-120-B-0-A-AAA	30470812
63	14	34	40	160	45	10	121	M10x1	5	30464621	10083410	10083270	MHC-HSK-A063-14-160-B-0-A-AAA	30470820
63	14	34	40	200	45	10	161	M10x1	5	30464631	10083410	10083270	MHC-HSK-A063-14-200-B-0-A-AAA	30470830
63	16	38	45	95	48	10	56	M12x1	5	30386554	10083388	10083270	MHC-HSK-A063-16-095-B-0-A-AAA	30386458
63	16	38	-	120	48	10	91	M12x1	5	30464614	10083411	10083270	MHC-HSK-A063-16-120-B-0-A-AAA	30470813
63	16	38	-	160	48	10	131	M12x1	5	30464622	10083411	10083270	MHC-HSK-A063-16-160-B-0-A-AAA	30470821
63	16	38	-	200	48	10	171	M12x1	5	30464632	10083411	10083270	MHC-HSK-A063-16-200-B-0-A-AAA	30470831
63	18	40	45	95	48	10	56	M12x1	5	30386555	10083389	10083270	MHC-HSK-A063-18-095-B-0-A-AAA	30386459
63	18	40	-	120	48	10	89	M12x1	5	30464615	10083412	10083270	MHC-HSK-A063-18-120-B-0-A-AAA	30470814
63	18	40	-	160	48	10	129	M12x1	5	30464623	10083412	10083270	MHC-HSK-A063-18-160-B-0-A-AAA	30470822
63	18	40	-	200	48	10	169	M12x1	5	30464633	10083412	10083270	MHC-HSK-A063-18-200-B-0-A-AAA	30470832
63	20	42	50	100	50	10	61	M16x1	5	30386556	10083390	10083270	MHC-HSK-A063-20-100-B-0-A-AAA	30386460
63	20	42	-	120	50	10	89	M16x1	5	30464616	10083413	10083270	MHC-HSK-A063-20-120-B-0-A-AAA	30470815
63	20	42	-	160	50	10	129	M16x1	5	30464624	10083413	10083270	MHC-HSK-A063-20-160-B-0-A-AAA	30470823
63	20	42	-	200	50	10	169	M16x1	5	30464634	10083413	10083270	MHC-HSK-A063-20-200-B-0-A-AAA	30470833
63	25	57	-	115	56	10	89	M16x1	5	30386557	10083391	10083270	MHC-HSK-A063-25-115-B-0-A-AAA	30386461
63	25	57	-	160	56	10	134	M16x1	5	30464625	10083414	10083270	MHC-HSK-A063-25-160-B-0-A-AAA	30470824
63	25	57	-	200	56	10	174	M16x1	5	30464635	10083414	10083270	MHC-HSK-A063-25-200-B-0-A-AAA	30470834
63	32	63	-	120	60	10	94	M16x1	5	30386558	10083392	10083270	MHC-HSK-A063-32-120-B-0-A-AAA	30386462
63	32	63	-	160	60	10	134	M16x1	5	30464626	10083415	10083270	MHC-HSK-A063-32-160-B-0-A-AAA	30470825
63	32	63	-	200	60	10	174	M16x1	5	30464636	10083415	10083270	MHC-HSK-A063-32-200-B-0-A-AAA	30470835
100	6	26	45	85	36	10	37	M10x1	4	30386569	30383941	10083272	MHC-HSK-A100-06-085-B-0-A-AAA	30386810
100	6	26	38	120	36	10	74	M5	2	30464665	30383945	10083272	MHC-HSK-A100-06-120-B-0-A-AAA	30470864
100	6	26	38	160	36	10	114	M5	2	30464673	30383945	10083272	MHC-HSK-A100-06-160-B-0-A-AAA	30470872
100	6	30	38	200	36	10	155	M5	2	30464683	30383945	10083272	MHC-HSK-A100-06-200-B-0-A-AAA	30470882
100	8	28	45	85	36	10	37	M10x1	4	30386570	10083384	10083272	MHC-HSK-A100-08-085-B-0-A-AAA	30386812
100	8	28	38	120	36	10	74	M7	3	30464666	10083394	10083272	MHC-HSK-A100-08-120-B-0-A-AAA	30470865
100	8	28	38	160	36	10	114	M7	3	30464674	10083394	10083272	MHC-HSK-A100-08-160-B-0-A-AAA	30470873
100	8	32	38	200	36	10	156	M7	3	30464684	10083394	10083272	MHC-HSK-A100-08-200-B-0-A-AAA	30470883
100	10	30	45	90	40	10	43	M10x1	4	30386571	10083385	10083272	MHC-HSK-A100-10-090-B-0-A-AAA	30386813
100	10	30	40	120	40	10	75	M8x1	4	30464667	10083401	10083272	MHC-HSK-A100-10-120-B-0-A-AAA	30470866
100	10	30	40	160	40	10	115	M8x1	4	30464675	10083401	10083272	MHC-HSK-A100-10-160-B-0-A-AAA	30470874
100	10	31	40	200	40	10	155	M8x1	4	30464685	10083401	10083272	MHC-HSK-A100-10-200-B-0-A-AAA	30470884
100	12	32	45	95	45	10	49	M10x1	5	30386572	10083386	10083272	MHC-HSK-A100-12-095-B-0-A-AAA	30386814
100	12	32	40	120	45	10	75	M10x1	5	30464668	10083409	10083272	MHC-HSK-A100-12-120-B-0-A-AAA	30470867
100	12	32	40	160	45	10	115	M10x1	5	30464676	10083409	10083272	MHC-HSK-A100-12-160-B-0-A-AAA	30470875
100	12	32	40	200	45	10	155	M10x1	5	30464686	10083409	10083272	MHC-HSK-A100-12-200-B-0-A-AAA	30470885

Continued on next page.

## 1-channel system MQL hydraulic chuck HydroChuck | Available on request

HSK-A	Dimensions							G	AF	Components			Specification	Order no.
	d <sub>1</sub>	d <sub>2</sub>	d <sub>3</sub>	l <sub>1</sub>	l <sub>2</sub>	l <sub>3</sub>	l <sub>4</sub>			BDY	LS	CU		
100	14	34	45	95	45	10	49	M10x1	5	30386573	10083387	10083272	MHC-HSK-A100-14-095-B-0-A-AAA	30386815
100	14	34	40	120	45	10	76	M10x1	5	30464669	10083410	10083272	MHC-HSK-A100-14-120-B-0-A-AAA	30470868
100	14	34	40	160	45	10	116	M10x1	5	30464677	10083410	10083272	MHC-HSK-A100-14-160-B-0-A-AAA	30470876
100	14	34	40	200	45	10	156	M10x1	5	30464687	10083410	10083272	MHC-HSK-A100-14-200-B-0-A-AAA	30470886
100	16	38	45	100	48	10	55	M12x1	5	30386574	10083388	10083272	MHC-HSK-A100-16-100-B-0-A-AAA	30386816
100	16	38	-	120	48	10	81	M12x1	5	30464670	10083411	10083272	MHC-HSK-A100-16-120-B-0-A-AAA	30470869
100	16	38	-	160	48	10	121	M12x1	5	30464678	10083411	10083272	MHC-HSK-A100-16-160-B-0-A-AAA	30470877
100	16	38	-	200	48	10	161	M12x1	5	30464688	10083411	10083272	MHC-HSK-A100-16-200-B-0-A-AAA	30470887
100	18	40	45	100	48	10	56	M12x1	5	30386575	10083389	10083272	MHC-HSK-A100-18-100-B-0-A-AAA	30386817
100	18	40	-	120	48	10	81	M12x1	5	30464671	10083412	10083272	MHC-HSK-A100-18-120-B-0-A-AAA	30470870
100	18	40	-	160	48	10	121	M12x1	5	30464679	10083412	10083272	MHC-HSK-A100-18-160-B-0-A-AAA	30470878
100	18	40	-	200	48	10	161	M12x1	5	30464689	10083412	10083272	MHC-HSK-A100-18-200-B-0-A-AAA	30470888
100	20	42	50	105	50	10	60	M16x1	5	30386576	10083390	10083272	MHC-HSK-A100-20-105-B-0-A-AAA	30386818
100	20	42	-	120	50	10	81	M16x1	5	30464672	10083413	10083272	MHC-HSK-A100-20-120-B-0-A-AAA	30470871
100	20	42	-	160	50	10	121	M16x1	5	30464680	10083413	10083272	MHC-HSK-A100-20-160-B-0-A-AAA	30470879
100	20	42	-	200	50	10	161	M16x1	5	30464690	10083413	10083272	MHC-HSK-A100-20-200-B-0-A-AAA	30470889
100	25	57	-	115	56	10	86	M16x1	5	30386577	10083391	10083272	MHC-HSK-A100-25-115-B-0-A-AAA	30386819
100	25	57	-	160	56	10	131	M16x1	5	30464681	10083414	10083272	MHC-HSK-A100-25-160-B-0-A-AAA	30470880
100	25	57	-	200	56	10	171	M16x1	5	30464691	10083414	10083272	MHC-HSK-A100-25-200-B-0-A-AAA	30470890
100	32	63	-	120	60	10	91	M16x1	5	30386578	10083392	10083272	MHC-HSK-A100-32-120-B-0-A-AAA	30386820
100	32	63	-	160	60	10	131	M16x1	5	30464682	10083415	10083272	MHC-HSK-A100-32-160-B-0-A-AAA	30470881
100	32	63	-	200	60	10	171	M16x1	5	30464692	10083415	10083272	MHC-HSK-A100-32-200-B-0-A-AAA	30470891

Dimensions in mm.

Use: To clamp tools with smooth cylindrical shanks according to DIN 1835 form A, DIN 6535 form HA as well as with recesses according to DIN 1835 form B, E and DIN 6535 form HB, HE directly and without reducing sleeve in the clamping diameter. The clamping diameter is designed for a shank tolerance of h6.

Scope of delivery: Tool body, length adjustment screw and coolant unit as assembly. These components can also be ordered separately (see table).

Design: Highest tool life and production quality when using smooth cylindrical shanks according to DIN 1835 form A and DIN 6535 form HA. With a projection length of 2.5xD (max. 50 mm) radial run-out accuracy 3 µm. When using cylindrical shanks with an inclined clamping surface (form E and form HE), the accuracy may be impaired. Different versions with chip available on request.

Balancing quality: G 2.5 with 25,000 rpm in delivery state.

# 1-channel system MQL shrink chuck ThermoChuck

For manual tool change, with axial tool length adjustment  
 HSK-A (hollow shank taper form A) shank according to DIN 69893-1

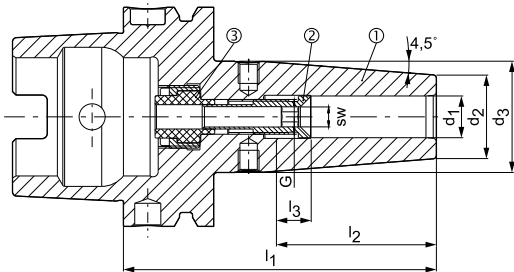

- ① Shrink chuck, HSK, MQL, tool body | BDY
- ② Length adjustment screw, MQL | LS
- ③ Coolant supply unit, MQL, manual | CU



**Available on request**

HSK-A	Dimensions						G	AF	Components			Specification	Order no.
	d <sub>1</sub>	d <sub>2</sub>	d <sub>3</sub>	l <sub>1</sub>	l <sub>2</sub>	l <sub>3</sub>			BDY	LS	CU		
40	6	21	27	80	36	10	M7	3	10083221	10083370	10083268	MTC-HSK-A040-06-080-B-0-A-AAA	30180001
40	8	21	27	80	36	10	M7	3	10083222	10083371	10083268	MTC-HSK-A040-08-080-B-0-A-AAA	30180002
40	10	24	32	80	40	10	M8x1	3	10083223	10083372	10083268	MTC-HSK-A040-10-080-B-0-A-AAA	30180003
40	12	24	32	90	45	10	M10x1	3	10083224	10083373	10083268	MTC-HSK-A040-12-090-B-0-A-AAA	30180004
40	14	27	34	90	45	10	M10x1	3	10083225	10083374	10083268	MTC-HSK-A040-14-090-B-0-A-AAA	30180005
40	16	27	34	90	48	10	M12x1	3	10083226	10083375	10083268	MTC-HSK-A040-16-090-B-0-A-AAA	30180006
50	6	21	27	80	36	10	M8x1	4	10083227	10083376	10083269	MTC-HSK-A050-06-080-B-0-A-AAA	30180007
50	8	21	27	80	36	10	M8x1	4	10083228	10083377	10083269	MTC-HSK-A050-08-080-B-0-A-AAA	30180008
50	10	24	32	85	40	10	M8x1	4	10083229	10083378	10083269	MTC-HSK-A050-10-085-B-0-A-AAA	30180009
50	12	24	32	90	45	10	M10x1	4	10083230	10083379	10083269	MTC-HSK-A050-12-090-B-0-A-AAA	30180010
50	14	27	34	90	45	10	M10x1	4	10083231	10083380	10083269	MTC-HSK-A050-14-090-B-0-A-AAA	30180011
50	16	27	34	95	48	10	M12x1	4	10083232	10083381	10083269	MTC-HSK-A050-16-095-B-0-A-AAA	30180012
50	18	33	42	95	48	10	M12x1	4	10083233	10083382	10083269	MTC-HSK-A050-18-095-B-0-A-AAA	30180013
50	20	33	42	100	50	10	M16x1	4	10083234	10083383	10083269	MTC-HSK-A050-20-100-B-0-A-AAA	30180014
63	6	21	27	80	36	10	M10x1	4	10083235	30383941	10083270	MTC-HSK-A063-06-080-B-0-A-AAA	30380806
63	6	21	27	120	36	10	M5	2	30386128	30383945	10083270	MTC-HSK-A063-06-120-B-0-A-AAA	30386041
63	6	21	27	160	36	10	M5	2	30386130	30383945	10083270	MTC-HSK-A063-06-160-B-0-A-AAA	30386044
63	6	21	27	200	36	10	M5	2	30386132	30383945	10083270	MTC-HSK-A063-06-200-B-0-A-AAA	30386047
63	8	21	27	80	36	10	M10x1	4	10083236	10083384	10083270	MTC-HSK-A063-08-080-B-0-A-AAA	30380807
63	8	21	27	120	36	10	M7	3	30386129	10083394	10083270	MTC-HSK-A063-08-120-B-0-A-AAA	30386042
63	8	21	27	160	36	10	M7	3	30386131	10083394	10083270	MTC-HSK-A063-08-160-B-0-A-AAA	30386045
63	8	21	27	200	36	10	M7	3	30386133	10083394	10083270	MTC-HSK-A063-08-200-B-0-A-AAA	30386048
63	10	24	32	85	40	10	M10x1	4	10083237	10083385	10083270	MTC-HSK-A063-10-085-B-0-A-AAA	30380808
63	10	24	32	120	40	10	M8x1	4	30386800	10083401	10083270	MTC-HSK-A063-10-120-B-0-A-AAA	30386043
63	10	24	32	160	40	10	M8x1	4	30386802	10083401	10083270	MTC-HSK-A063-10-160-B-0-A-AAA	30386046
63	10	24	32	200	40	10	M8x1	4	30386134	10083401	10083270	MTC-HSK-A063-10-200-B-0-A-AAA	30386049
63	12	24	32	90	45	10	M10x1	5	10083238	10083386	10083270	MTC-HSK-A063-12-090-B-0-A-AAA	30380809
63	12	24	32	120	45	10	M10x1	5	10096023	10083409	10083270	MTC-HSK-A063-12-120-B-0-A-AAA	30340365
63	12	24	32	160	45	10	M10x1	5	30197953	10083409	10083270	MTC-HSK-A063-12-160-B-0-A-AAA	30197954
63	12	24	32	200	45	10	M10x1	5	10107285	10083409	10083270	MTC-HSK-A063-12-200-B-0-A-AAA	30340376
63	14	27	34	90	45	10	M10x1	5	10083239	10083387	10083270	MTC-HSK-A063-14-090-B-0-A-AAA	30380810
63	14	27	34	120	45	10	M10x1	5	30192712	10083410	10083270	MTC-HSK-A063-14-120-B-0-A-AAA	30192710
63	14	27	34	160	45	10	M10x1	5	10096025	10083410	10083270	MTC-HSK-A063-14-160-B-0-A-AAA	30340369
63	14	27	34	200	45	10	M10x1	5	10096026	10083410	10083270	MTC-HSK-A063-14-200-B-0-A-AAA	30340377
63	16	27	34	95	48	10	M12x1	5	10083240	10083388	10083270	MTC-HSK-A063-16-095-B-0-A-AAA	30380811
63	16	27	34	120	48	10	M12x1	5	10107287	10083411	10083270	MTC-HSK-A063-16-120-B-0-A-AAA	30340366
63	16	27	34	160	48	10	M12x1	5	10107288	10083411	10083270	MTC-HSK-A063-16-160-B-0-A-AAA	30340370
63	16	27	34	200	48	10	M12x1	5	10107289	10083411	10083270	MTC-HSK-A063-16-200-B-0-A-AAA	30340378
63	18	33	42	95	48	10	M12x1	5	10083241	10083389	10083270	MTC-HSK-A063-18-095-B-0-A-AAA	30380812

1-channel system MQL shrink chuck ThermoChuck | Available on request

HSK-A	Dimensions						G	AF	Components			Specification	Order no.
	d <sub>1</sub>	d <sub>2</sub>	d <sub>3</sub>	l <sub>1</sub>	l <sub>2</sub>	l <sub>3</sub>			BDY	LS	CU		
63	18	33	42	120	48	10	M12x1	5	10107292	10083412	10083270	MTC-HSK-A063-18-120-B-0-A-AAA	30340367
63	18	33	42	160	48	10	M12x1	5	10096027	10083412	10083270	MTC-HSK-A063-18-160-B-0-A-AAA	30340371
63	18	33	42	200	48	10	M12x1	5	10107293	10083412	10083270	MTC-HSK-A063-18-200-B-0-A-AAA	30340379
63	20	33	42	100	50	10	M16x1	5	10083242	10083390	10083270	MTC-HSK-A063-20-100-B-0-A-AAA	30380813
63	20	33	42	120	50	10	M16x1	5	30192716	10083413	10083270	MTC-HSK-A063-20-120-B-0-A-AAA	30192715
63	20	33	42	160	50	10	M16x1	5	10107294	10083413	10083270	MTC-HSK-A063-20-160-B-0-A-AAA	30340372
63	20	33	42	200	50	10	M16x1	5	10107295	10083413	10083270	MTC-HSK-A063-20-200-B-0-A-AAA	30340380
63	25	44	53	115	56	10	M16x1	5	10083243	10083391	10083270	MTC-HSK-A063-25-115-B-0-A-AAA	30380814
63	25	44	53	160	56	10	M16x1	5	10107296	10083414	10083270	MTC-HSK-A063-25-160-B-0-A-AAA	30340373
63	25	44	53	200	56	10	M16x1	5	10107297	10083414	10083270	MTC-HSK-A063-25-200-B-0-A-AAA	30340381
63	32	44	53	120	60	10	M16x1	5	10083244	10083392	10083270	MTC-HSK-A063-32-120-B-0-A-AAA	30380815
63	32	44	53	160	60	10	M16x1	5	10107298	10083415	10083270	MTC-HSK-A063-32-160-B-0-A-AAA	30340374
63	32	44	53	200	60	10	M16x1	5	10107299	10083415	10083270	MTC-HSK-A063-32-200-B-0-A-AAA	30340382
80	6	21	27	85	36	10	M10x1	4	10083245	30383941	10083271	MTC-HSK-A080-06-085-B-0-A-AAA	30380844
80	8	21	27	85	36	10	M10x1	4	10083246	10083384	10083271	MTC-HSK-A080-08-085-B-0-A-AAA	30380845
80	10	24	32	90	40	10	M10x1	4	10083247	10083385	10083271	MTC-HSK-A080-10-090-B-0-A-AAA	30380846
80	12	24	32	95	45	10	M10x1	5	10083248	10083386	10083271	MTC-HSK-A080-12-095-B-0-A-AAA	30380847
80	14	27	34	95	45	10	M10x1	5	10083249	10083387	10083271	MTC-HSK-A080-14-095-B-0-A-AAA	30380848
80	16	27	34	100	48	10	M12x1	5	10083250	10083388	10083271	MTC-HSK-A080-16-100-B-0-A-AAA	30380849
80	18	33	42	100	48	10	M12x1	5	10083251	10083389	10083271	MTC-HSK-A080-18-100-B-0-A-AAA	30380850
80	20	33	42	105	50	10	M16x1	5	10083252	10083390	10083271	MTC-HSK-A080-20-105-B-0-A-AAA	30380851
80	25	44	53	115	56	10	M16x1	5	10083253	10083391	10083271	MTC-HSK-A080-25-115-B-0-A-AAA	30380852
80	32	44	53	120	60	10	M16x1	5	10083254	10083392	10083271	MTC-HSK-A080-32-120-B-0-A-AAA	30380853
100	6	21	27	85	36	10	M10x1	4	10083255	30383941	10083272	MTC-HSK-A100-06-085-B-0-A-AAA	30380882
100	6	21	27	120	36	10	M5	2	30386144	30383945	10083272	MTC-HSK-A100-06-120-B-0-A-AAA	30386059
100	6	21	27	160	36	10	M5	2	30386147	30383945	10083272	MTC-HSK-A100-06-160-B-0-A-AAA	30386062
100	6	21	27	200	36	10	M5	2	30386150	30383945	10083272	MTC-HSK-A100-06-200-B-0-A-AAA	30386065
100	8	21	27	85	36	10	M10x1	4	10083256	10083384	10083272	MTC-HSK-A100-08-085-B-0-A-AAA	30380883
100	8	21	27	120	36	10	M7	3	30386145	10083394	10083272	MTC-HSK-A100-08-120-B-0-A-AAA	30386060
100	8	21	27	160	36	10	M7	3	30386148	10083394	10083272	MTC-HSK-A100-08-160-B-0-A-AAA	30386063
100	8	21	27	200	36	10	M7	3	30386151	10083394	10083272	MTC-HSK-A100-08-200-B-0-A-AAA	30386066
100	10	24	32	90	40	10	M10x1	4	10083257	10083385	10083272	MTC-HSK-A100-10-090-B-0-A-AAA	30380884
100	10	24	32	120	40	10	M8x1	4	30386146	10083401	10083272	MTC-HSK-A100-10-120-B-0-A-AAA	30386061
100	10	24	32	160	40	10	M8x1	4	30386149	10083401	10083272	MTC-HSK-A100-10-160-B-0-A-AAA	30386064
100	10	24	32	200	40	10	M8x1	4	30386152	10083401	10083272	MTC-HSK-A100-10-200-B-0-A-AAA	30386067
100	12	24	32	95	45	10	M10x1	5	10083258	10083386	10083272	MTC-HSK-A100-12-095-B-0-A-AAA	30380885
100	12	24	32	120	45	10	M10x1	5	30253151	10083409	10083272	MTC-HSK-A100-12-120-B-0-A-AAA	30480245
100	12	24	32	160	45	10	M10x1	5	30302825	10083409	10083272	MTC-HSK-A100-12-160-B-0-A-AAA	30480250
100	12	24	32	200	45	10	M10x1	5	30253152	10083409	10083272	MTC-HSK-A100-12-200-B-0-A-AAA	30480257
100	14	27	34	95	45	10	M10x1	5	10083259	10083387	10083272	MTC-HSK-A100-14-095-B-0-A-AAA	30380886
100	14	27	34	120	45	10	M10x1	5	30254306	10083410	10083272	MTC-HSK-A100-14-120-B-0-A-AAA	30480246
100	14	27	34	160	45	10	M10x1	5	30302826	10083410	10083272	MTC-HSK-A100-14-160-B-0-A-AAA	30480251
100	14	27	34	200	45	10	M10x1	5	30303050	10083410	10083272	MTC-HSK-A100-14-200-B-0-A-AAA	30480258
100	16	27	34	100	48	10	M12x1	5	10083260	10083388	10083272	MTC-HSK-A100-16-100-B-0-A-AAA	30380887
100	16	27	34	120	48	10	M12x1	5	30302821	10083411	10083272	MTC-HSK-A100-16-120-B-0-A-AAA	30480247
100	16	27	34	160	48	10	M12x1	5	30302827	10083411	10083272	MTC-HSK-A100-16-160-B-0-A-AAA	30480252
100	16	27	34	200	48	10	M12x1	5	30302831	10083411	10083272	MTC-HSK-A100-16-200-B-0-A-AAA	30480259
100	18	33	42	100	48	10	M12x1	5	10083261	10083389	10083272	MTC-HSK-A100-18-100-B-0-A-AAA	30380888
100	18	33	42	120	48	10	M12x1	5	30253155	10083412	10083272	MTC-HSK-A100-18-120-B-0-A-AAA	30480248
100	18	33	42	160	48	10	M12x1	5	10096879	10083412	10083272	MTC-HSK-A100-18-160-B-0-A-AAA	30480253
100	18	33	42	200	48	10	M12x1	5	10107134	10083412	10083272	MTC-HSK-A100-18-200-B-0-A-AAA	30480260
100	20	33	42	105	50	10	M16x1	5	10083262	10083390	10083272	MTC-HSK-A100-20-105-B-0-A-AAA	30380889
100	20	33	42	120	50	10	M16x1	5	30302822	10083413	10083272	MTC-HSK-A100-20-120-B-0-A-AAA	30480249
100	20	33	42	160	50	10	M16x1	5	10096880	10083413	10083272	MTC-HSK-A100-20-160-B-0-A-AAA	30480254
100	20	33	42	200	50	10	M16x1	5	30302832	10083413	10083272	MTC-HSK-A100-20-200-B-0-A-AAA	30480261
100	25	44	53	115	56	10	M16x1	5	10083263	10083391	10083272	MTC-HSK-A100-25-115-B-0-A-AAA	30380890
100	25	44	53	160	56	10	M16x1	5	30258455	10083414	10083272	MTC-HSK-A100-25-160-B-0-A-AAA	30480255



**1-channel system MQL shrink chuck ThermoChuck | Available on request**

HSK-A	Dimensions						G	AF	Components			Specification	Order no.
	d <sub>1</sub>	d <sub>2</sub>	d <sub>3</sub>	l <sub>1</sub>	l <sub>2</sub>	l <sub>3</sub>			BDY	LS	CU		
100	25	44	53	200	56	10	M16x1	5	30302833	10083414	10083272	MTC-HSK-A100-25-200-B-0-A-AAA	30480262
100	32	44	53	120	60	10	M16x1	5	10083264	10083392	10083272	MTC-HSK-A100-32-120-B-0-A-AAA	30380891
100	32	44	53	160	60	10	M16x1	5	30303048	10083415	10083272	MTC-HSK-A100-32-160-B-0-A-AAA	30480256
100	32	44	53	200	60	10	M16x1	5	30302834	10083415	10083272	MTC-HSK-A100-32-200-B-0-A-AAA	30480263

Dimensions in mm.

Scope of delivery: Tool body, length adjustment screw and coolant unit as assembly. These components can also be ordered separately (see table).

Design: Permissible run-out variation of the hollow taper shank in relation to the clamping diameter  $d_1 = 3 \mu\text{m}$ . The clamping diameter is designed for a shank tolerance of h6.

Different versions with chip available on request.

Balancing quality: G 2.5 with 25,000 rpm in delivery state.

# 2-channel system MQL hydraulic chuck HydroChuck

For automatic tool change, with axial tool length adjustment  
 HSK-A (hollow shank taper form A) shank according to DIN 69893-1

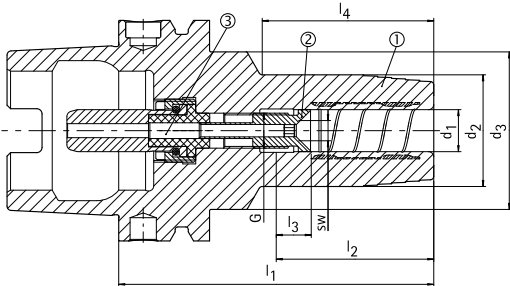

- ① Hydraulic chucks, HSK, MQL, tool body material | BDY
- ② Length adjustment screw, MQL | LS
- ③ Coolant supply unit, MQL, automatic | CU



### Preferred series available from stock

Variant*	HSK-A	Dimensions							G	A <sub>IN</sub> mm <sup>2</sup>	AF	Components			Specification	Order no.
		d <sub>1</sub>	d <sub>2</sub>	d <sub>3</sub>	l <sub>1</sub>	l <sub>2</sub>	l <sub>3</sub>	l <sub>4</sub>				BDY	LS	CU		
	63	6	26	45	80	36	10	37	M10x1	1,54	1,5	30386549	30512784	30512203	MHC-HSK-A063-06-080-C-0-A-AAA1	30522882
	63	6	26	45	80	36	10	37	M10x1	4,52	2	30386549	30384039	30384304	MHC-HSK-A063-06-080-C-0-A-AAA2	30386278
	63	6	26	38	120	36	10	78	M5	1,54	1,5	30464609	30512804	30512203	MHC-HSK-A063-06-120-C-0-A-AAA1	30522916
	63	6	26	38	120	36	10	78	M5	4,52	2	30464609	30384040	30384304	MHC-HSK-A063-06-120-C-0-A-AAA2	30485332
	63	8	28	45	80	36	10	37,5	M10x1	1,54	1,5	30386550	30512785	30512203	MHC-HSK-A063-08-080-C-0-A-AAA1	30522883
	63	8	28	45	80	36	10	37,5	M10x1	4,52	2	30386550	30384043	30384304	MHC-HSK-A063-08-080-C-0-A-AAA2	30386279
	63	8	28	38	120	36	10	78,5	M7	1,54	1,5	30464610	30512805	30512203	MHC-HSK-A063-08-120-C-0-A-AAA1	30522917
	63	8	28	38	120	36	10	78,5	M7	4,52	2	30464610	30384044	30384304	MHC-HSK-A063-08-120-C-0-A-AAA2	30485333
	63	10	30	45	85	40	10	43,5	M10x1	1,54	1,5	30386551	30512786	30512203	MHC-HSK-A063-10-085-C-0-A-AAA1	30522884
	63	10	30	45	85	40	10	43,5	M10x1	4,52	2	30386551	30384011	30384304	MHC-HSK-A063-10-085-C-0-A-AAA2	30386280
	63	10	30	40	120	40	10	79	M8x1	1,54	1,5	30464611	30512806	30512203	MHC-HSK-A063-10-120-C-0-A-AAA1	30522918
	63	10	30	40	120	40	10	79	M8x1	4,52	2	30464611	30384012	30384304	MHC-HSK-A063-10-120-C-0-A-AAA2	30485334
	63	12	32	45	90	45	10	49	M10x1	1,54	1,5	30386552	30512791	30512203	MHC-HSK-A063-12-090-C-0-A-AAA1	30522885
	63	12	32	45	90	45	10	49	M10x1	4,52	2	30386552	30512787	30384304	MHC-HSK-A063-12-090-C-0-A-AAA2	30522886
	63	12	32	45	90	45	10	49	M10x1	9,9	3	30386552	30279400	30284772	MHC-HSK-A063-12-090-C-0-A-AAA3	30386281
	63	12	32	40	120	45	10	80,5	M10x1	1,54	1,5	30464612	30512811	30512203	MHC-HSK-A063-12-120-C-0-A-AAA1	30522919
	63	12	32	40	120	45	10	80,5	M10x1	4,52	2	30464612	30512807	30384304	MHC-HSK-A063-12-120-C-0-A-AAA2	30522920
	63	12	32	40	120	45	10	80,5	M10x1	9,9	3	30464612	30279402	30284772	MHC-HSK-A063-12-120-C-0-A-AAA3	30485335
	63	14	34	45	90	45	10	49,5	M10x1	1,54	1,5	30386553	30512792	30512203	MHC-HSK-A063-14-090-C-0-A-AAA1	30522887
	63	14	34	45	90	45	10	49,5	M10x1	4,52	2	30386553	30512788	30384304	MHC-HSK-A063-14-090-C-0-A-AAA2	30522888
	63	14	34	45	90	45	10	49,5	M10x1	9,9	3	30386553	30279407	30284772	MHC-HSK-A063-14-090-C-0-A-AAA3	30386282
	63	14	34	40	120	45	10	81	M10x1	1,54	1,5	30464613	30512813	30512203	MHC-HSK-A063-14-120-C-0-A-AAA1	30522921
	63	14	34	40	120	45	10	81	M10x1	4,52	2	30464613	30512808	30384304	MHC-HSK-A063-14-120-C-0-A-AAA2	30522922
	63	14	34	40	120	45	10	81	M10x1	9,9	3	30464613	30279408	30284772	MHC-HSK-A063-14-120-C-0-A-AAA3	30485336
	63	16	38	45	95	48	10	55,5	M12x1	1,54	1,5	30386554	30512793	30512203	MHC-HSK-A063-16-095-C-0-A-AAA1	30522889
	63	16	38	45	95	48	10	55,5	M12x1	4,52	2	30386554	30512789	30384304	MHC-HSK-A063-16-095-C-0-A-AAA2	30522890
	63	16	38	45	95	48	10	55,5	M12x1	9,9	3	30386554	30279413	30284772	MHC-HSK-A063-16-095-C-0-A-AAA3	30386283
	63	16	38	-	120	48	10	91,1	M12x1	1,54	1,5	30464614	30512814	30512203	MHC-HSK-A063-16-120-C-0-A-AAA1	30522923
	63	16	38	-	120	48	10	91,1	M12x1	4,52	2	30464614	30512809	30384304	MHC-HSK-A063-16-120-C-0-A-AAA2	30522924
	63	16	38	-	120	48	10	91,1	M12x1	9,9	3	30464614	30279414	30284772	MHC-HSK-A063-16-120-C-0-A-AAA3	30485337
	63	18	40	45	95	48	10	56	M12x1	1,54	1,5	30386555	30512794	30512203	MHC-HSK-A063-18-095-C-0-A-AAA1	30522891
	63	18	40	45	95	48	10	56	M12x1	4,52	2	30386555	30512790	30384304	MHC-HSK-A063-18-095-C-0-A-AAA2	30522892
	63	18	40	45	95	48	10	56	M12x1	9,9	3	30386555	30279420	30284772	MHC-HSK-A063-18-095-C-0-A-AAA3	30386284
	63	18	40	-	120	48	10	89,1	M12x1	1,54	1,5	30464615	30512815	30512203	MHC-HSK-A063-18-120-C-0-A-AAA1	30522925
	63	18	40	-	120	48	10	89,1	M12x1	4,52	2	30464615	30512810	30384304	MHC-HSK-A063-18-120-C-0-A-AAA2	30522926
	63	18	40	-	120	48	10	89,1	M12x1	9,9	3	30464615	30279422	30284772	MHC-HSK-A063-18-120-C-0-A-AAA3	30485338
	63	20	42	50	100	50	10	60,5	M16x1	4,52	2	30386556	30512798	30384304	MHC-HSK-A063-20-100-C-0-A-AAA1	30522893
	63	20	42	50	100	50	10	60,5	M16x1	9,9	3	30386556	30512795	30284772	MHC-HSK-A063-20-100-C-0-A-AAA2	30522894
	63	20	42	50	100	50	10	60,5	M16x1	17,35	4	30386556	30279429	30279444	MHC-HSK-A063-20-100-C-0-A-AAA3	30386285

**2-channel system MQL hydraulic chuck HydroChuck | For automatic tool change, with axial tool length adjustment**  
**HSK-A shank in accordance with DIN 69893-1 | Preferred series available from stock**

Variant*	HSK-A	Dimensions							G	A <sub>IN</sub>	AF	Components			Specification	Order no.
		d <sub>1</sub>	d <sub>2</sub>	d <sub>3</sub>	l <sub>1</sub>	l <sub>2</sub>	l <sub>3</sub>	l <sub>4</sub>				BDY	LS	CU		
	63	20	42	-	120	50	10	89,1	M16x1	4,52	2	30464616	30512817	30384304	MHC-HSK-A063-20-120-C-0-A-AAA1	30522927
	63	20	42	-	120	50	10	89,1	M16x1	9,9	3	30464616	30512816	30284772	MHC-HSK-A063-20-120-C-0-A-AAA2	30522928
	63	20	42	-	120	50	10	89,1	M16x1	17,35	4	30464616	30279422	30279444	MHC-HSK-A063-20-120-C-0-A-AAA3	30485339
	63	25	57	-	115	56	10	89	M16x1	4,52	2	30386557	30512799	30384304	MHC-HSK-A063-25-115-C-0-A-AAA1	30522895
	63	25	57	-	115	56	10	89	M16x1	9,9	3	30386557	30512796	30284772	MHC-HSK-A063-25-115-C-0-A-AAA2	30522896
	63	25	57	-	115	56	10	89	M16x1	17,35	4	30386557	30279434	30279444	MHC-HSK-A063-25-115-C-0-A-AAA3	30386286
	63	32	63	-	120	60	10	94	M16x1	4,52	2	30386558	30512800	30384304	MHC-HSK-A063-32-120-C-0-A-AAA1	30522897
	63	32	63	-	120	60	10	94	M16x1	9,9	3	30386558	30512797	30284772	MHC-HSK-A063-32-120-C-0-A-AAA2	30522898
	63	32	63	-	120	60	10	94	M16x1	17,35	4	30386558	30279441	30279444	MHC-HSK-A063-32-120-C-0-A-AAA3	30386287
	100	6	26	45	85	36	10	36,5	M10x1	1,54	1,5	30386569	30512784	30521106	MHC-HSK-A100-06-085-C-0-A-AAA1	30523138
	100	6	26	45	85	36	10	36,5	M10x1	4,52	2	30386569	30384039	30384306	MHC-HSK-A100-06-085-C-0-A-AAA2	30386319
	100	8	28	45	85	36	10	37	M10x1	1,54	1,5	30386570	30512785	30521106	MHC-HSK-A100-08-085-C-0-A-AAA1	30523139
	100	8	28	45	85	36	10	37	M10x1	4,52	2	30386570	30384043	30384306	MHC-HSK-A100-08-085-C-0-A-AAA2	30386320
	100	10	30	45	90	40	10	43	M10x1	1,54	1,5	30386571	30512786	30521106	MHC-HSK-A100-10-090-C-0-A-AAA1	30523140
	100	10	30	45	90	40	10	43	M10x1	4,52	2	30386571	30384011	30384306	MHC-HSK-A100-10-090-C-0-A-AAA2	30386321
	100	12	32	45	95	45	10	48,5	M10x1	1,54	1,5	30386572	30512791	30521106	MHC-HSK-A100-12-095-C-0-A-AAA1	30523141
	100	12	32	45	95	45	10	48,5	M10x1	4,52	2	30386572	30512787	30384306	MHC-HSK-A100-12-095-C-0-A-AAA2	30523142
	100	12	32	45	95	45	10	48,5	M10x1	9,9	3	30386572	30279400	30297309	MHC-HSK-A100-12-095-C-0-A-AAA3	30386322
	100	14	34	45	95	45	10	49	M10x1	1,54	1,5	30386573	30512792	30521106	MHC-HSK-A100-14-095-C-0-A-AAA1	30523143
	100	14	34	45	95	45	10	49	M10x1	4,52	2	30386573	30512788	30384306	MHC-HSK-A100-14-095-C-0-A-AAA2	30523144
	100	14	34	45	95	45	10	49	M10x1	9,9	3	30386573	30279407	30297309	MHC-HSK-A100-14-095-C-0-A-AAA3	30386323
	100	16	38	45	100	48	10	55	M12x1	1,54	1,5	30386574	30512793	30521106	MHC-HSK-A100-16-100-C-0-A-AAA1	30523145
	100	16	38	45	100	48	10	55	M12x1	4,52	2	30386574	30512789	30384306	MHC-HSK-A100-16-100-C-0-A-AAA2	30523146
	100	16	38	45	100	48	10	55	M12x1	9,9	3	30386574	30279413	30297309	MHC-HSK-A100-16-100-C-0-A-AAA3	30386324
	100	18	40	45	100	48	10	55,5	M12x1	1,54	1,5	30386575	30512794	30521106	MHC-HSK-A100-18-100-C-0-A-AAA1	30523147
	100	18	40	45	100	48	10	55,5	M12x1	4,52	2	30386575	30512790	30384306	MHC-HSK-A100-18-100-C-0-A-AAA2	30523148
	100	18	40	45	100	48	10	55,5	M12x1	9,9	3	30386575	30279420	30297309	MHC-HSK-A100-18-100-C-0-A-AAA3	30386325
	100	20	42	50	105	50	10	60	M16x1	4,52	2	30386576	30512798	30384306	MHC-HSK-A100-20-105-C-0-A-AAA1	30523149
	100	20	42	50	105	50	10	60	M16x1	9,9	3	30386576	30512795	30297309	MHC-HSK-A100-20-105-C-0-A-AAA2	30523150
	100	20	42	50	105	50	10	60	M16x1	17,35	4	30386576	30279429	30297310	MHC-HSK-A100-20-105-C-0-A-AAA3	30386326
	100	25	57	-	115	56	10	86	M16x1	4,52	2	30386577	30512799	30384306	MHC-HSK-A100-25-115-C-0-A-AAA1	30523151
	100	25	57	-	115	56	10	86	M16x1	9,9	3	30386577	30512796	30297309	MHC-HSK-A100-25-115-C-0-A-AAA2	30523152
	100	25	57	-	115	56	10	86	M16x1	17,35	4	30386577	30279434	30297310	MHC-HSK-A100-25-115-C-0-A-AAA3	30386327
	100	32	63	-	120	60	10	91	M16x1	4,52	2	30386578	30512800	30384306	MHC-HSK-A100-32-120-C-0-A-AAA1	30523153
	100	32	63	-	120	60	10	91	M16x1	9,9	3	30386578	30512797	30297309	MHC-HSK-A100-32-120-C-0-A-AAA2	30523154
	100	32	63	-	120	60	10	91	M16x1	17,35	4	30386578	30279441	30297310	MHC-HSK-A100-32-120-C-0-A-AAA3	30386328

\* The exact determination of the variant can be found in the selection system for 2-channel system chucks.  
 The preferred series is marked with a green .

Dimensions in mm.

Use: To clamp tools with smooth cylindrical shanks according to DIN 1835 form A, DIN 6535 form HA as well as with recesses according to DIN 1835 form B, E and DIN 6535 form HB, HE directly and without reducing sleeve in the clamping diameter. The clamping diameter is designed for a shank tolerance of h6.

Scope of delivery: Tool body, length adjustment screw and coolant unit as assembly. These components can also be ordered separately (see table).

Design: Highest tool life and production quality when using smooth cylindrical shanks according to DIN 1835 form A and DIN 6535 form HA. With a projection length of 2.5xD (max. 50 mm) radial run-out accuracy 3 µm. When using cylindrical shanks with an inclined clamping surface (form E and form HE), the accuracy may be impaired. Different versions with chip available on request.

Balancing quality: G 2.5 with 25,000 rpm in delivery state.

# 2-channel system MQL hydraulic chuck HydroChuck

For automatic tool change, with axial tool length adjustment  
 HSK-A (hollow shank taper form A) shank according to DIN 69893-1

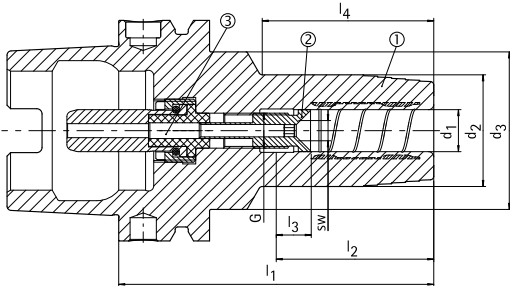

- ① Hydraulic chucks, HSK, MQL, tool body material | BDY
- ② Length adjustment screw, MQL | LS
- ③ Coolant supply unit, MQL, automatic | CU



Available on request

Variant*	HSK-A	Dimensions							G	A <sub>IN</sub> mm <sup>2</sup>	AF	Components			Specification	Order no.
		d <sub>1</sub>	d <sub>2</sub>	d <sub>3</sub>	l <sub>1</sub>	l <sub>2</sub>	l <sub>3</sub>	l <sub>4</sub>				BDY	LS	CU		
	40	6	26	33,5	80	36	10	49	M7	1,54	1,5	30386529	30512726	30521102	MHC-HSK-A040-06-080-C-0-A-AAA1	30522750
	40	6	26	33,5	80	36	10	49	M7	4,52	2	30386529	30383971	30384302	MHC-HSK-A040-06-080-C-0-A-AAA2	30386249
	40	6	26	33,5	120	36	10	86	M5	1,54	1,5	30464569	30512735	30521102	MHC-HSK-A040-06-120-C-0-A-AAA1	30522768
	40	6	26	33,5	120	36	10	86	M5	4,52	2	30464569	30383972	30384302	MHC-HSK-A040-06-120-C-0-A-AAA2	30485276
	40	6	26	33,5	160	36	10	118	M5	1,54	1,5	30464575	30512744	30521102	MHC-HSK-A040-06-160-C-0-A-AAA1	30522786
	40	6	26	33,5	160	36	10	118	M5	4,52	2	30464575	30383973	30384302	MHC-HSK-A040-06-160-C-0-A-AAA2	30485288
	40	8	28	33,5	80	36	10	50,5	M7	1,54	1,5	30386530	30512727	30521102	MHC-HSK-A040-08-080-C-0-A-AAA1	30522751
	40	8	28	33,5	80	36	10	50,5	M7	4,52	2	30386530	30383974	30384302	MHC-HSK-A040-08-080-C-0-A-AAA2	30386250
	40	8	28	33,5	120	36	10	86,5	M7	1,54	1,5	30464570	30512736	30521102	MHC-HSK-A040-08-120-C-0-A-AAA1	30522769
	40	8	28	33,5	120	36	10	86,5	M7	4,52	2	30464570	30383975	30384302	MHC-HSK-A040-08-120-C-0-A-AAA2	30485277
	40	8	28	33,5	160	36	10	118	M7	1,54	1,5	30464576	30512745	30521102	MHC-HSK-A040-08-160-C-0-A-AAA1	30522787
	40	8	28	33,5	160	36	10	118	M7	4,52	2	30464576	30383976	30384302	MHC-HSK-A040-08-160-C-0-A-AAA2	30485289
	40	10	30	33,5	80	40	10	52	M8x1	1,54	1,5	30386531	30512728	30521102	MHC-HSK-A040-10-080-C-0-A-AAA1	30522752
	40	10	30	33,5	80	40	10	52	M8x1	4,52	2	30386531	30383959	30384302	MHC-HSK-A040-10-080-C-0-A-AAA2	30386251
	40	10	30	33,5	120	40	10	87	M8x1	1,54	1,5	30464571	30512737	30521102	MHC-HSK-A040-10-120-C-0-A-AAA1	30522770
	40	10	30	33,5	120	40	10	87	M8x1	4,52	2	30464571	30383960	30384302	MHC-HSK-A040-10-120-C-0-A-AAA2	30485278
	40	10	30	33,5	160	40	10	127	M8x1	1,54	1,5	30464577	30512746	30521102	MHC-HSK-A040-10-160-C-0-A-AAA1	30522788
	40	10	30	33,5	160	40	10	127	M8x1	4,52	2	30464577	30383961	30384302	MHC-HSK-A040-10-160-C-0-A-AAA2	30485290
	40	12	32	33,5	90	45	10	62	M10x1	1,54	1,5	30386532	30512732	30521102	MHC-HSK-A040-12-090-C-0-A-AAA1	30522753
	40	12	32	33,5	90	45	10	62	M10x1	4,52	2	30386532	30512729	30384302	MHC-HSK-A040-12-090-C-0-A-AAA2	30522754
	40	12	32	33,5	90	45	10	62	M10x1	9,9	3	30386532	30280050	30297304	MHC-HSK-A040-12-090-C-0-A-AAA3	30386252
	40	12	32	33,5	120	45	10	91,5	M10x1	1,54	1,5	30464572	30512741	30521102	MHC-HSK-A040-12-120-C-0-A-AAA1	30522771
	40	12	32	33,5	120	45	10	91,5	M10x1	4,52	2	30464572	30512738	30384302	MHC-HSK-A040-12-120-C-0-A-AAA2	30522772
	40	12	32	33,5	120	45	10	91,5	M10x1	9,9	3	30464572	30302842	30297304	MHC-HSK-A040-12-120-C-0-A-AAA3	30485279
	40	12	32	33,5	160	45	10	126	M10x1	1,54	1,5	30464578	30512750	30521102	MHC-HSK-A040-12-160-C-0-A-AAA1	30522789
	40	12	32	33,5	160	45	10	126	M10x1	4,52	2	30464578	30512747	30384302	MHC-HSK-A040-12-160-C-0-A-AAA2	30522790
	40	12	32	33,5	160	45	10	126	M10x1	9,9	3	30464578	30302848	30297304	MHC-HSK-A040-12-160-C-0-A-AAA3	30485291
	40	14	34	45	90	45	10	39,5	M10x1	1,54	1,5	30386533	30512733	30521102	MHC-HSK-A040-14-090-C-0-A-AAA1	30522755
	40	14	34	45	90	45	10	39,5	M10x1	4,52	2	30386533	30512730	30384302	MHC-HSK-A040-14-090-C-0-A-AAA2	30522756
	40	14	34	45	90	45	10	39,5	M10x1	9,9	3	30386533	30280051	30297304	MHC-HSK-A040-14-090-C-0-A-AAA3	30386253
	40	14	34	-	120	45	10	100	M10x1	1,54	1,5	30464573	30512742	30521102	MHC-HSK-A040-14-120-C-0-A-AAA1	30522773
	40	14	34	-	120	45	10	100	M10x1	4,52	2	30464573	30512739	30384302	MHC-HSK-A040-14-120-C-0-A-AAA2	30522774
	40	14	34	-	120	45	10	100	M10x1	9,9	3	30464573	30302843	30297304	MHC-HSK-A040-14-120-C-0-A-AAA3	30485280
	40	14	34	-	160	45	10	140	M10x1	1,54	1,5	30464579	30512751	30521102	MHC-HSK-A040-14-160-C-0-A-AAA1	30522791
	40	14	34	-	160	45	10	140	M10x1	4,52	2	30464579	30512748	30384302	MHC-HSK-A040-14-160-C-0-A-AAA2	30522792
	40	14	34	-	160	45	10	140	M10x1	9,9	3	30464579	30302849	30297304	MHC-HSK-A040-14-160-C-0-A-AAA3	30485292
	40	16	38	50	90	48	10	39	M12x1	1,54	1,5	30386534	30512734	30521102	MHC-HSK-A040-16-090-C-0-A-AAA1	30522757
	40	16	38	50	90	48	10	39	M12x1	4,52	2	30386534	30512731	30384302	MHC-HSK-A040-16-090-C-0-A-AAA2	30522758
	40	16	38	50	90	48	10	39	M12x1	9,9	3	30386534	30280052	30297304	MHC-HSK-A040-16-090-C-0-A-AAA3	30386254

**2-channel system MQL hydraulic chuck HydroChuck | For automatic tool change, with axial tool length adjustment**  
**HSK-A shank in accordance with DIN 69893-1 | Available on request**

Variant*	HSK-A	Dimensions								G	A <sub>IN</sub> mm <sup>2</sup>	AF	Components			Specification	Order no.
		d <sub>1</sub>	d <sub>2</sub>	d <sub>3</sub>	l <sub>1</sub>	l <sub>2</sub>	l <sub>3</sub>	l <sub>4</sub>	BDY				LS	CU			
	40	16	38	-	120	48	10	100	M12x1	1,54	1,5	30464574	30512743	30521102	MHC-HSK-A040-16-120-C-0-A-AAA1	30522775	
	40	16	38	-	120	48	10	100	M12x1	4,52	2	30464574	30512740	30384302	MHC-HSK-A040-16-120-C-0-A-AAA2	30522776	
	40	16	38	-	120	48	10	100	M12x1	9,9	3	30464574	30302844	30297304	MHC-HSK-A040-16-120-C-0-A-AAA3	30485281	
	40	16	38	-	160	48	10	140	M12x1	1,54	1,5	30464580	30512752	30521102	MHC-HSK-A040-16-160-C-0-A-AAA1	30522793	
	40	16	38	-	160	48	10	140	M12x1	4,52	2	30464580	30512749	30384302	MHC-HSK-A040-16-160-C-0-A-AAA2	30522794	
	40	16	38	-	160	48	10	140	M12x1	9,9	3	30464580	30302850	30297304	MHC-HSK-A040-16-160-C-0-A-AAA3	30485293	
	50	6	26	40	80	36	10	38,5	M8x1	1,54	1,5	30386541	30512753	30521103	MHC-HSK-A050-06-080-C-0-A-AAA1	30522804	
	50	6	26	40	80	36	10	38,5	M8x1	4,52	2	30386541	30384009	30384303	MHC-HSK-A050-06-080-C-0-A-AAA2	30386261	
	50	6	26	35	120	36	10	80	M5	1,54	1,5	30464593	30512756	30521103	MHC-HSK-A050-06-120-C-0-A-AAA1	30522830	
	50	6	26	35	120	36	10	80	M5	4,52	2	30464593	30383998	30384303	MHC-HSK-A050-06-120-C-0-A-AAA2	30485300	
	50	6	26	35	160	36	10	118	M5	1,54	1,5	30464601	30512770	30521103	MHC-HSK-A050-06-160-C-0-A-AAA1	30522856	
	50	6	26	35	160	36	10	118	M5	4,52	2	30464601	30383999	30384303	MHC-HSK-A050-06-160-C-0-A-AAA2	30485316	
	50	8	28	40	80	36	10	39	M8x1	1,54	1,5	30386542	30512754	30521103	MHC-HSK-A050-08-080-C-0-A-AAA1	30522805	
	50	8	28	40	80	36	10	39	M8x1	4,52	2	30386542	30384010	30384303	MHC-HSK-A050-08-080-C-0-A-AAA2	30386262	
	50	8	28	35	120	36	10	80	M7	1,54	1,5	30464594	30512757	30521103	MHC-HSK-A050-08-120-C-0-A-AAA1	30522831	
	50	8	28	35	120	36	10	80	M7	4,52	2	30464594	30384001	30384303	MHC-HSK-A050-08-120-C-0-A-AAA2	30485301	
	50	8	28	35	160	36	10	118	M7	1,54	1,5	30464602	30512771	30521103	MHC-HSK-A050-08-160-C-0-A-AAA1	30522857	
	50	8	28	35	160	36	10	118	M7	4,52	2	30464602	30384002	30384303	MHC-HSK-A050-08-160-C-0-A-AAA2	30485317	
	50	10	30	40	85	40	10	44,5	M8x1	1,54	1,5	30386543	30512755	30521103	MHC-HSK-A050-10-085-C-0-A-AAA1	30522806	
	50	10	30	40	85	40	10	44,5	M8x1	4,52	2	30386543	30384004	30384303	MHC-HSK-A050-10-085-C-0-A-AAA2	30386263	
	50	10	30	38	120	40	10	80	M8x1	1,54	1,5	30464595	30512758	30521103	MHC-HSK-A050-10-120-C-0-A-AAA1	30522832	
	50	10	30	38	120	40	10	80	M8x1	4,52	2	30464595	30383977	30384303	MHC-HSK-A050-10-120-C-0-A-AAA2	30485302	
	50	10	30	38	160	40	10	120	M8x1	1,54	1,5	30464603	30512772	30521103	MHC-HSK-A050-10-160-C-0-A-AAA1	30522858	
	50	10	30	38	160	40	10	120	M8x1	4,52	2	30464603	30383978	30384303	MHC-HSK-A050-10-160-C-0-A-AAA2	30485318	
	50	12	32	40	90	45	10	53	M10x1	1,54	1,5	30386544	30512791	30521103	MHC-HSK-A050-12-090-C-0-A-AAA1	30522807	
	50	12	32	40	90	45	10	53	M10x1	4,52	2	30386544	30512787	30384303	MHC-HSK-A050-12-090-C-0-A-AAA2	30522808	
	50	12	32	40	90	45	10	53	M10x1	9,9	3	30386544	30279400	30297305	MHC-HSK-A050-12-090-C-0-A-AAA3	30386264	
	50	12	32	38	120	45	10	81	M10x1	1,54	1,5	30464596	30512763	30521103	MHC-HSK-A050-12-120-C-0-A-AAA1	30522833	
	50	12	32	38	120	45	10	81	M10x1	4,52	2	30464596	30512759	30384303	MHC-HSK-A050-12-120-C-0-A-AAA2	30522834	
	50	12	32	38	120	45	10	81	M10x1	9,9	3	30464596	30302854	30297305	MHC-HSK-A050-12-120-C-0-A-AAA3	30485303	
	50	12	32	38	160	45	10	121	M10x1	1,54	1,5	30464604	30512777	30521103	MHC-HSK-A050-12-160-C-0-A-AAA1	30522859	
	50	12	32	38	160	45	10	121	M10x1	4,52	2	30464604	30512773	30384303	MHC-HSK-A050-12-160-C-0-A-AAA2	30522860	
	50	12	32	38	160	45	10	121	M10x1	9,9	3	30464604	30302862	30297305	MHC-HSK-A050-12-160-C-0-A-AAA3	30485319	
	50	14	34	40	90	45	10	54,5	M10x1	1,54	1,5	30386545	30512792	30521103	MHC-HSK-A050-14-090-C-0-A-AAA1	30522809	
	50	14	34	40	90	45	10	54,5	M10x1	4,52	2	30386545	30512788	30384303	MHC-HSK-A050-14-090-C-0-A-AAA2	30522810	
	50	14	34	40	90	45	10	54,5	M10x1	9,9	3	30386545	30279407	30297305	MHC-HSK-A050-14-090-C-0-A-AAA3	30386265	
	50	14	34	38	120	45	10	81,5	M10x1	1,54	1,5	30464597	30512764	30521103	MHC-HSK-A050-14-120-C-0-A-AAA1	30522835	
	50	14	34	38	120	45	10	81,5	M10x1	4,52	2	30464597	30512760	30384303	MHC-HSK-A050-14-120-C-0-A-AAA2	30522836	
	50	14	34	38	120	45	10	81,5	M10x1	9,9	3	30464597	30302855	30297305	MHC-HSK-A050-14-120-C-0-A-AAA3	30485304	
	50	14	34	38	160	45	10	121,5	M10x1	1,54	1,5	30464605	30512778	30521103	MHC-HSK-A050-14-160-C-0-A-AAA1	30522861	
	50	14	34	38	160	45	10	121,5	M10x1	4,52	2	30464605	30512774	30384303	MHC-HSK-A050-14-160-C-0-A-AAA2	30522862	
	50	14	34	38	160	45	10	121,5	M10x1	9,9	3	30464605	30302863	30297305	MHC-HSK-A050-14-160-C-0-A-AAA3	30485320	
	50	16	38	41,5	95	48	10	61	M12x1	1,54	1,5	30386546	30512793	30521103	MHC-HSK-A050-16-095-C-0-A-AAA1	30522811	
	50	16	38	41,5	95	48	10	61	M12x1	4,52	2	30386546	30512789	30384303	MHC-HSK-A050-16-095-C-0-A-AAA2	30522812	
	50	16	38	41,5	95	48	10	61	M12x1	9,9	3	30386546	30279413	30297305	MHC-HSK-A050-16-095-C-0-A-AAA3	30386266	
	50	16	38	-	120	48	10	94	M12x1	1,54	1,5	30464598	30512765	30521103	MHC-HSK-A050-16-120-C-0-A-AAA1	30522837	
	50	16	38	-	120	48	10	94	M12x1	4,52	2	30464598	30512761	30384303	MHC-HSK-A050-16-120-C-0-A-AAA2	30522838	
	50	16	38	-	120	48	10	94	M12x1	9,9	3	30464598	30302856	30297305	MHC-HSK-A050-16-120-C-0-A-AAA3	30485305	
	50	16	38	-	160	48	10	134	M12x1	1,54	1,5	30464606	30512779	30521103	MHC-HSK-A050-16-160-C-0-A-AAA1	30522863	
	50	16	38	-	160	48	10	134	M12x1	4,52	2	30464606	30512775	30384303	MHC-HSK-A050-16-160-C-0-A-AAA2	30522864	
	50	16	38	-	160	48	10	134	M12x1	9,9	3	30464606	30302864	30297305	MHC-HSK-A050-16-160-C-0-A-AAA3	30485321	
	50	18	40	41,5	95	48	10	62,5	M12x1	1,54	1,5	30386547	30512794	30521103	MHC-HSK-A050-18-095-C-0-A-AAA1	30522813	
	50	18	40	41,5	95	48	10	62,5	M12x1	4,52	2	30386547	30512790	30384303	MHC-HSK-A050-18-095-C-0-A-AAA2	30522814	
	50	18	40	41,5	95	48	10	62,5	M12x1	9,9	3	30386547	30279420	30297305	MHC-HSK-A050-18-095-C-0-A-AAA3	30386267	
	50	18	40	-	120	48	10	94	M12x1	1,54	1,5	30464599	30512766	30521103	MHC-HSK-A050-18-120-C-0-A-AAA2	30522839	
	50	18	40	-	120	48	10	94	M12x1	4,52	2	30464599	30512762	30384303	MHC-HSK-A050-18-120-C-0-A-AAA3	30522840	

**2-channel system MQL hydraulic chuck HydroChuck | For automatic tool change, with axial tool length adjustment  
HSK-A shank in accordance with DIN 69893-1 | Available on request**

Variant*	HSK-A	Dimensions								G	A <sub>IN</sub> mm <sup>2</sup>	AF	Components			Specification	Order no.
		d <sub>1</sub>	d <sub>2</sub>	d <sub>3</sub>	l <sub>1</sub>	l <sub>2</sub>	l <sub>3</sub>	l <sub>4</sub>	BDY				LS	CU			
	50	18	40	-	120	48	10	94	M12x1	9,9	3	30464599	30302857	30297305	MHC-HSK-A050-18-120-C-0-A-AAA2	30485306	
	50	18	40	-	160	48	10	134	M12x1	1,54	1,5	30464607	30512780	30521103	MHC-HSK-A050-18-160-C-0-A-AAA3	30522865	
	50	18	40	-	160	48	10	134	M12x1	4,52	2	30464607	30512776	30384303	MHC-HSK-A050-18-160-C-0-A-AAA2	30522866	
	50	18	40	-	160	48	10	134	M12x1	9,9	3	30464607	30302865	30297305	MHC-HSK-A050-18-160-C-0-A-AAA3	30485322	
	50	20	42	55	100	50	10	42	M16x1	4,52	2	30386548	30512798	30521103	MHC-HSK-A050-20-100-C-0-A-AAA1	30522815	
	50	20	42	55	100	50	10	42	M16x1	9,9	3	30386548	30512795	30384303	MHC-HSK-A050-20-100-C-0-A-AAA2	30522816	
	50	20	42	55	100	50	10	42	M16x1	17,35	4	30386548	30279429	30297305	MHC-HSK-A050-20-100-C-0-A-AAA3	30386268	
	50	20	42	-	120	50	10	94	M16x1	4,52	2	30464600	30512768	30521103	MHC-HSK-A050-20-120-C-0-A-AAA2	30522841	
	50	20	42	-	120	50	10	94	M16x1	9,9	3	30464600	30512767	30384303	MHC-HSK-A050-20-120-C-0-A-AAA3	30522842	
	50	20	42	-	120	50	10	94	M16x1	17,35	4	30464600	30302858	30297305	MHC-HSK-A050-20-120-C-0-A-AAA2	30485307	
	50	20	42	-	160	50	10	134	M16x1	4,52	2	30464608	30512782	30521103	MHC-HSK-A050-20-160-C-0-A-AAA3	30522867	
	50	20	42	-	160	50	10	134	M16x1	9,9	3	30464608	30512781	30384303	MHC-HSK-A050-20-160-C-0-A-AAA2	30522868	
	50	20	42	-	160	50	10	134	M16x1	17,35	4	30464608	30302866	30297305	MHC-HSK-A050-20-160-C-0-A-AAA3	30485323	
	63	6	26	38	160	36	10	118,0	M5	1,54	1,5	30464617	30512819	30512203	MHC-HSK-A063-06-160-C-0-A-AAA1	30522942	
	63	6	26	38	160	36	10	118,0	M5	4,52	2,0	30464617	30384041	30384304	MHC-HSK-A063-06-160-C-0-A-AAA2	30485348	
	63	6	26	38	200	36	10	155,0	M5	1,54	1,5	30464627	30512839	30512203	MHC-HSK-A063-06-200-C-0-A-AAA1	30522976	
	63	6	26	38	200	36	10	155,0	M5	4,52	2,0	30464627	30384042	30384304	MHC-HSK-A063-06-200-C-0-A-AAA2	30485368	
	63	8	28	38	160	36	10	118,5	M7	1,54	1,5	30464618	30512820	30512203	MHC-HSK-A063-08-160-C-0-A-AAA1	30522943	
	63	8	28	38	160	36	10	118,5	M7	4,52	2,0	30464618	30384045	30384304	MHC-HSK-A063-08-160-C-0-A-AAA2	30485349	
	63	8	28	38	200	36	10	155,5	M7	1,54	1,5	30464628	30512840	30512203	MHC-HSK-A063-08-200-C-0-A-AAA1	30522977	
	63	8	28	38	200	36	10	155,5	M7	4,52	2,0	30464628	30384046	30384304	MHC-HSK-A063-08-200-C-0-A-AAA2	30485369	
	63	10	30	40	160	40	10	115,0	M8x1	1,54	1,5	30464619	30512821	30512203	MHC-HSK-A063-10-160-C-0-A-AAA1	30522944	
	63	10	30	40	160	40	10	115,0	M8x1	4,52	2,0	30464619	30384013	30384304	MHC-HSK-A063-10-160-C-0-A-AAA2	30485350	
	63	10	30	40	200	40	10	155,0	M8x1	1,54	1,5	30464629	30512841	30512203	MHC-HSK-A063-10-200-C-0-A-AAA1	30522978	
	63	10	30	40	200	40	10	155,0	M8x1	4,52	2,0	30464629	30384014	30384304	MHC-HSK-A063-10-200-C-0-A-AAA2	30485370	
	63	12	32	40	160	45	10	120,5	M10x1	1,54	1,5	30464620	30512826	30512203	MHC-HSK-A063-12-160-C-0-A-AAA1	30522945	
	63	12	32	40	160	45	10	120,5	M10x1	4,52	2,0	30464620	30512822	30384304	MHC-HSK-A063-12-160-C-0-A-AAA2	30522946	
	63	12	32	40	160	45	10	120,5	M10x1	9,90	3,0	30464620	30279404	30284772	MHC-HSK-A063-12-160-C-0-A-AAA3	30485351	
	63	12	32	40	200	45	10	160,5	M10x1	1,54	1,5	30464630	30512846	30512203	MHC-HSK-A063-12-200-C-0-A-AAA1	30522979	
	63	12	32	40	200	45	10	160,5	M10x1	4,52	2,0	30464630	30512842	30384304	MHC-HSK-A063-12-200-C-0-A-AAA2	30522980	
	63	12	32	40	200	45	10	160,5	M10x1	9,90	3,0	30464630	30279405	30284772	MHC-HSK-A063-12-200-C-0-A-AAA3	30485371	
	63	14	34	40	160	45	10	121,0	M10x1	1,54	1,5	30464621	30512827	30512203	MHC-HSK-A063-14-160-C-0-A-AAA1	30522947	
	63	14	34	40	160	45	10	121,0	M10x1	4,52	2,0	30464621	30512823	30384304	MHC-HSK-A063-14-160-C-0-A-AAA2	30522948	
	63	14	34	40	160	45	10	121,0	M10x1	9,90	3,0	30464621	30279410	30284772	MHC-HSK-A063-14-160-C-0-A-AAA3	30485352	
	63	14	34	40	200	45	10	161,0	M10x1	1,54	1,5	30464631	30512847	30512203	MHC-HSK-A063-14-200-C-0-A-AAA1	30522981	
	63	14	34	40	200	45	10	161,0	M10x1	4,52	2,0	30464631	30512843	30384304	MHC-HSK-A063-14-200-C-0-A-AAA2	30522982	
	63	14	34	40	200	45	10	161,0	M10x1	9,90	3,0	30464631	30279412	30284772	MHC-HSK-A063-14-200-C-0-A-AAA3	30485372	
	63	16	38	-	160	48	10	131,1	M12x1	1,54	1,5	30464622	30512828	30512203	MHC-HSK-A063-16-160-C-0-A-AAA1	30522949	
	63	16	38	-	160	48	10	131,1	M12x1	4,52	2,0	30464622	30512824	30384304	MHC-HSK-A063-16-160-C-0-A-AAA2	30522950	
	63	16	38	-	160	48	10	131,1	M12x1	9,90	3,0	30464622	30279416	30284772	MHC-HSK-A063-16-160-C-0-A-AAA3	30485353	
	63	16	38	-	200	48	10	171,1	M12x1	1,54	1,5	30464632	30512848	30512203	MHC-HSK-A063-16-200-C-0-A-AAA1	30522983	
	63	16	38	-	200	48	10	171,1	M12x1	4,52	2,0	30464632	30512844	30384304	MHC-HSK-A063-16-200-C-0-A-AAA2	30522984	
	63	16	38	-	200	48	10	171,1	M12x1	9,90	3,0	30464632	30279418	30284772	MHC-HSK-A063-16-200-C-0-A-AAA3	30485373	
	63	18	40	-	160	48	10	129,1	M12x1	1,54	1,5	30464623	30512829	30512203	MHC-HSK-A063-18-160-C-0-A-AAA1	30522951	
	63	18	40	-	160	48	10	129,1	M12x1	4,52	2,0	30464623	30512825	30384304	MHC-HSK-A063-18-160-C-0-A-AAA2	30522952	
	63	18	40	-	160	48	10	129,1	M12x1	9,90	3,0	30464623	30279423	30284772	MHC-HSK-A063-18-160-C-0-A-AAA3	30485354	
	63	18	40	-	200	48	10	169,1	M12x1	1,54	1,5	30464633	30512849	30512203	MHC-HSK-A063-18-200-C-0-A-AAA1	30522985	
	63	18	40	-	200	48	10	169,1	M12x1	4,52	2,0	30464633	30512845	30384304	MHC-HSK-A063-18-200-C-0-A-AAA2	30522986	
	63	18	40	-	200	48	10	169,1	M12x1	9,90	3,0	30464633	30279427	30284772	MHC-HSK-A063-18-200-C-0-A-AAA3	30485374	
	63	20	42	-	160	50	10	129,1	M16x1	4,52	2,0	30464624	30512833	30384304	MHC-HSK-A063-20-160-C-0-A-AAA1	30522953	
	63	20	42	-	160	50	10	129,1	M16x1	9,90	3,0	30464624	30512830	30284772	MHC-HSK-A063-20-160-C-0-A-AAA2	30522954	
	63	20	42	-	160	50	10	129,1	M16x1	17,35	4,0	30464624	30279432	30279444	MHC-HSK-A063-20-160-C-0-A-AAA3	30485355	
	63	20	42	-	200	50	10	169,1	M16x1	4,52	2,0	30464634	30512853	30384304	MHC-HSK-A063-20-200-C-0-A-AAA1	30522987	
	63	20	42	-	200	50	10	169,1	M16x1	9,90	3,0	30464634	30512850	30284772	MHC-HSK-A063-20-200-C-0-A-AAA2	30522988	
	63	20	42	-	200	50	10	169,1	M16x1	17,35	4,0	30464634	30279433	30279444	MHC-HSK-A063-20-200-C-0-A-AAA3	30485375	
	63	25	57	-	160	56	10	134,0	M16x1	4,52	2,0	30464625	30512834	30384304	MHC-HSK-A063-25-160-C-0-A-AAA1	30522955	

**2-channel system MQL hydraulic chuck HydroChuck | For automatic tool change, with axial tool length adjustment  
 HSK-A shank in accordance with DIN 69893-1 | Available on request**

Variant*	HSK-A	Dimensions							G	A <sub>IN</sub> mm <sup>2</sup>	AF	Components			Specification	Order no.
		d <sub>1</sub>	d <sub>2</sub>	d <sub>3</sub>	l <sub>1</sub>	l <sub>2</sub>	l <sub>3</sub>	l <sub>4</sub>				BDY	LS	CU		
63	25	57	-	160	56	10	134,0	M16x1	9,90	3,0	30464625	30512831	30284772	MHC-HSK-A063-25-160-C-0-A-AAA2	30522956	
63	25	57	-	160	56	10	134,0	M16x1	17,35	4,0	30464625	30279435	30279444	MHC-HSK-A063-25-160-C-0-A-AAA3	30485356	
63	25	57	-	200	56	10	174,0	M16x1	4,52	2,0	30464635	30512854	30384304	MHC-HSK-A063-25-200-C-0-A-AAA1	30522989	
63	25	57	-	200	56	10	174,0	M16x1	9,90	3,0	30464635	30512851	30284772	MHC-HSK-A063-25-200-C-0-A-AAA2	30522990	
63	25	57	-	200	56	10	174,0	M16x1	17,35	4,0	30464635	30279436	30279444	MHC-HSK-A063-25-200-C-0-A-AAA3	30485376	
63	32	63	-	160	60	10	134,0	M16x1	4,52	2,0	30464626	30512835	30384304	MHC-HSK-A063-32-160-C-0-A-AAA1	30522957	
63	32	63	-	160	60	10	134,0	M16x1	9,90	3,0	30464626	30512832	30284772	MHC-HSK-A063-32-160-C-0-A-AAA2	30522958	
63	32	63	-	160	60	10	134,0	M16x1	17,35	4,0	30464626	30279442	30279444	MHC-HSK-A063-32-160-C-0-A-AAA3	30485357	
63	32	63	-	200	60	10	174,0	M16x1	4,52	2,0	30464636	30512856	30384304	MHC-HSK-A063-32-200-C-0-A-AAA1	30522991	
63	32	63	-	200	60	10	174,0	M16x1	9,90	3,0	30464636	30512852	30284772	MHC-HSK-A063-32-200-C-0-A-AAA2	30522992	
63	32	63	-	200	60	10	174,0	M16x1	17,35	4,0	30464636	30279443	30279444	MHC-HSK-A063-32-200-C-0-A-AAA3	30485377	
100	6	26	38	120	36	10	73,5	M5	1,54	1,5	30464665	30512804	30521106	MHC-HSK-A100-06-120-C-0-A-AAA1	30523172	
100	6	26	38	120	36	10	73,5	M5	4,52	2	30464665	30384040	30384306	MHC-HSK-A100-06-120-C-0-A-AAA2	30485444	
100	6	26	38	160	36	10	113,5	M5	1,54	1,5	30464673	30512819	30521106	MHC-HSK-A100-06-160-C-0-A-AAA1	30523198	
100	6	26	38	160	36	10	113,5	M5	4,52	2	30464673	30384041	30384306	MHC-HSK-A100-06-160-C-0-A-AAA2	30485460	
100	6	26	38	200	36	10	155	M5	1,54	1,5	30464683	30512839	30521106	MHC-HSK-A100-06-200-C-0-A-AAA1	30523232	
100	6	26	38	200	36	10	155	M5	4,52	2	30464683	30384042	30384306	MHC-HSK-A100-06-200-C-0-A-AAA2	30485480	
100	8	28	38	120	36	10	74	M7	1,54	1,5	30464666	30512805	30521106	MHC-HSK-A100-08-120-C-0-A-AAA1	30523173	
100	8	28	38	120	36	10	74	M7	4,52	2	30464666	30384044	30384306	MHC-HSK-A100-08-120-C-0-A-AAA2	30485445	
100	8	28	38	160	36	10	114	M7	1,54	1,5	30464674	30512820	30521106	MHC-HSK-A100-08-160-C-0-A-AAA1	30523199	
100	8	28	38	160	36	10	114	M7	4,52	2	30464674	30384045	30384306	MHC-HSK-A100-08-160-C-0-A-AAA2	30485461	
100	8	28	38	200	36	10	155,5	M7	1,54	1,5	30464684	30512840	30521106	MHC-HSK-A100-08-200-C-0-A-AAA1	30523233	
100	8	28	38	200	36	10	155,5	M7	4,52	2	30464684	30384046	30384306	MHC-HSK-A100-08-200-C-0-A-AAA2	30485481	
100	10	30	40	120	40	10	74,5	M8x1	1,54	1,5	30464667	30512806	30521106	MHC-HSK-A100-10-120-C-0-A-AAA1	30523174	
100	10	30	40	120	40	10	74,5	M8x1	4,52	2	30464667	30384012	30384306	MHC-HSK-A100-10-120-C-0-A-AAA2	30485446	
100	10	30	40	160	40	10	114,5	M8x1	1,54	1,5	30464675	30512821	30521106	MHC-HSK-A100-10-160-C-0-A-AAA1	30523200	
100	10	30	40	160	40	10	114,5	M8x1	4,52	2	30464675	30384013	30384306	MHC-HSK-A100-10-160-C-0-A-AAA2	30485462	
100	10	30	40	200	40	10	155	M8x1	1,54	1,5	30464685	30512841	30521106	MHC-HSK-A100-10-200-C-0-A-AAA1	30523234	
100	10	30	40	200	40	10	155	M8x1	4,52	2	30464685	30384014	30384306	MHC-HSK-A100-10-200-C-0-A-AAA2	30485482	
100	12	32	40	120	45	10	75	M10x1	1,54	1,5	30464668	30512811	30521106	MHC-HSK-A100-12-120-C-0-A-AAA1	30523175	
100	12	32	40	120	45	10	75	M10x1	4,52	2	30464668	30512807	30384306	MHC-HSK-A100-12-120-C-0-A-AAA2	30523176	
100	12	32	40	120	45	10	75	M10x1	9,9	3	30464668	30279402	30297309	MHC-HSK-A100-12-120-C-0-A-AAA3	30485447	
100	12	32	40	160	45	10	115	M10x1	1,54	1,5	30464676	30512826	30521106	MHC-HSK-A100-12-160-C-0-A-AAA1	30523201	
100	12	32	40	160	45	10	115	M10x1	4,52	2	30464676	30512822	30384306	MHC-HSK-A100-12-160-C-0-A-AAA2	30523202	
100	12	32	40	160	45	10	115	M10x1	9,9	3	30464676	30279404	30297309	MHC-HSK-A100-12-160-C-0-A-AAA3	30485463	
100	12	32	40	200	45	10	155	M10x1	1,54	1,5	30464686	30512846	30521106	MHC-HSK-A100-12-200-C-0-A-AAA1	30523235	
100	12	32	40	200	45	10	155	M10x1	4,52	2	30464686	30512842	30384306	MHC-HSK-A100-12-200-C-0-A-AAA2	30523236	
100	12	32	40	200	45	10	155	M10x1	9,9	3	30464686	30279405	30297309	MHC-HSK-A100-12-200-C-0-A-AAA3	30485483	
100	14	34	40	120	45	10	75,5	M10x1	1,54	1,5	30464669	30512813	30521106	MHC-HSK-A100-14-120-C-0-A-AAA1	30523177	
100	14	34	40	120	45	10	75,5	M10x1	4,52	2	30464669	30512808	30384306	MHC-HSK-A100-14-120-C-0-A-AAA2	30523178	
100	14	34	40	120	45	10	75,5	M10x1	9,9	3	30464669	30279408	30297309	MHC-HSK-A100-14-120-C-0-A-AAA3	30485448	
100	14	34	40	160	45	10	115,5	M10x1	1,54	1,5	30464677	30512827	30521106	MHC-HSK-A100-14-160-C-0-A-AAA1	30523203	
100	14	34	40	160	45	10	115,5	M10x1	4,52	2	30464677	30512823	30384306	MHC-HSK-A100-14-160-C-0-A-AAA2	30523204	
100	14	34	40	160	45	10	115,5	M10x1	9,9	3	30464677	30279410	30297309	MHC-HSK-A100-14-160-C-0-A-AAA3	30485464	
100	14	34	40	200	45	10	155,5	M10x1	1,54	1,5	30464687	30512847	30521106	MHC-HSK-A100-14-200-C-0-A-AAA1	30523237	
100	14	34	40	200	45	10	155,5	M10x1	4,52	2	30464687	30512843	30384306	MHC-HSK-A100-14-200-C-0-A-AAA2	30523238	
100	14	34	40	200	45	10	155,5	M10x1	9,9	3	30464687	30279412	30297309	MHC-HSK-A100-14-200-C-0-A-AAA3	30485484	
100	16	38	-	120	48	10	81,1	M12x1	1,54	1,5	30464670	30512814	30521106	MHC-HSK-A100-16-120-C-0-A-AAA1	30523179	
100	16	38	-	120	48	10	81,1	M12x1	4,52	2	30464670	30512809	30384306	MHC-HSK-A100-16-120-C-0-A-AAA2	30523180	
100	16	38	-	120	48	10	81,1	M12x1	9,9	3	30464670	30279414	30297309	MHC-HSK-A100-16-120-C-0-A-AAA3	30485449	
100	16	38	-	160	48	10	121,1	M12x1	1,54	1,5	30464678	30512828	30521106	MHC-HSK-A100-16-160-C-0-A-AAA1	30523205	
100	16	38	-	160	48	10	121,1	M12x1	4,52	2	30464678	30512824	30384306	MHC-HSK-A100-16-160-C-0-A-AAA2	30523206	
100	16	38	-	160	48	10	121,1	M12x1	9,9	3	30464678	30279416	30297309	MHC-HSK-A100-16-160-C-0-A-AAA3	30485465	
100	16	38	-	200	48	10	161,1	M12x1	1,54	1,5	30464688	30512848	30521106	MHC-HSK-A100-16-200-C-0-A-AAA1	30523239	
100	16	38	-	200	48	10	161,1	M12x1	4,52	2	30464688	30512844	30384306	MHC-HSK-A100-16-200-C-0-A-AAA2	30523240	
100	16	38	-	200	48	10	161,1	M12x1	9,9	3	30464688	30279418	30297309	MHC-HSK-A100-16-200-C-0-A-AAA3	30485485	

**2-channel system MQL hydraulic chuck HydroChuck | For automatic tool change, with axial tool length adjustment**  
**HSK-A shank in accordance with DIN 69893-1 | Available on request**

Variant*	HSK-A	Dimensions							G	A <sub>IN</sub>	AF	Components			Specification	Order no.
		d <sub>1</sub>	d <sub>2</sub>	d <sub>3</sub>	l <sub>1</sub>	l <sub>2</sub>	l <sub>3</sub>	l <sub>4</sub>				BDY	LS	CU		
	100	18	40	-	120	48	10	81,1	M12x1	1,54	1,5	30464671	30512815	30521106	MHC-HSK-A100-18-120-C-0-A-AAA1	30523181
	100	18	40	-	120	48	10	81,1	M12x1	4,52	2	30464671	30512810	30384306	MHC-HSK-A100-18-120-C-0-A-AAA2	30523182
	100	18	40	-	120	48	10	81,1	M12x1	9,9	3	30464671	30279422	30297309	MHC-HSK-A100-18-120-C-0-A-AAA3	30485450
	100	18	40	-	160	48	10	121,1	M12x1	1,54	1,5	30464679	30512829	30521106	MHC-HSK-A100-18-160-C-0-A-AAA1	30523207
	100	18	40	-	160	48	10	121,1	M12x1	4,52	2	30464679	30512825	30384306	MHC-HSK-A100-18-160-C-0-A-AAA2	30523208
	100	18	40	-	160	48	10	121,1	M12x1	9,9	3	30464679	30279423	30297309	MHC-HSK-A100-18-160-C-0-A-AAA3	30485466
	100	18	40	-	200	48	10	161,1	M12x1	1,54	1,5	30464689	30512849	30521106	MHC-HSK-A100-18-200-C-0-A-AAA1	30523241
	100	18	40	-	200	48	10	161,1	M12x1	4,52	2	30464689	30512845	30384306	MHC-HSK-A100-18-200-C-0-A-AAA2	30523242
	100	18	40	-	200	48	10	161,1	M12x1	9,9	3	30464689	30279427	30297309	MHC-HSK-A100-18-200-C-0-A-AAA3	30485486
	100	20	42	-	120	50	10	81,1	M16x1	4,52	2	30464672	30512817	30384306	MHC-HSK-A100-20-120-C-0-A-AAA1	30523183
	100	20	42	-	120	50	10	81,1	M16x1	9,9	3	30464672	30512816	30297309	MHC-HSK-A100-20-120-C-0-A-AAA2	30523184
	100	20	42	-	120	50	10	81,1	M16x1	17,35	4	30464672	30279430	30297310	MHC-HSK-A100-20-120-C-0-A-AAA3	30485451
	100	20	42	-	160	50	10	121,1	M16x1	4,52	2	30464680	30512833	30384306	MHC-HSK-A100-20-160-C-0-A-AAA1	30523209
	100	20	42	-	160	50	10	121,1	M16x1	9,9	3	30464680	30512830	30297309	MHC-HSK-A100-20-160-C-0-A-AAA2	30523210
	100	20	42	-	160	50	10	121,1	M16x1	17,35	4	30464680	30279432	30297310	MHC-HSK-A100-20-160-C-0-A-AAA3	30485467
	100	20	42	-	200	50	10	161,1	M16x1	4,52	2	30464690	30512853	30384306	MHC-HSK-A100-20-200-C-0-A-AAA1	30523243
	100	20	42	-	200	50	10	161,1	M16x1	9,9	3	30464690	30512850	30297309	MHC-HSK-A100-20-200-C-0-A-AAA2	30523244
	100	20	42	-	200	50	10	161,1	M16x1	17,35	4	30464690	30279433	30297310	MHC-HSK-A100-20-200-C-0-A-AAA3	30485487
	100	25	57	-	160	56	10	131	M16x1	4,52	2	30464681	30512834	30384306	MHC-HSK-A100-25-160-C-0-A-AAA1	30523211
	100	25	57	-	160	56	10	131	M16x1	9,9	3	30464681	30512831	30297309	MHC-HSK-A100-25-160-C-0-A-AAA2	30523212
	100	25	57	-	160	56	10	131	M16x1	17,35	4	30464681	30279435	30297310	MHC-HSK-A100-25-160-C-0-A-AAA3	30485468
	100	25	57	-	200	56	10	171	M16x1	4,52	2	30464691	30512854	30384306	MHC-HSK-A100-25-200-C-0-A-AAA1	30523245
	100	25	57	-	200	56	10	171	M16x1	9,9	3	30464691	30512851	30297309	MHC-HSK-A100-25-200-C-0-A-AAA2	30523246
	100	25	57	-	200	56	10	171	M16x1	17,35	4	30464691	30279436	30297310	MHC-HSK-A100-25-200-C-0-A-AAA3	30485488
	100	32	63	-	160	60	10	131	M16x1	4,52	2	30464682	30512835	30384306	MHC-HSK-A100-32-160-C-0-A-AAA1	30523213
	100	32	63	-	160	60	10	131	M16x1	9,9	3	30464682	30512832	30297309	MHC-HSK-A100-32-160-C-0-A-AAA2	30523214
	100	32	63	-	160	60	10	131	M16x1	17,35	4	30464682	30279442	30297310	MHC-HSK-A100-32-160-C-0-A-AAA3	30485469
	100	32	63	-	200	60	10	171	M16x1	4,52	2	30464692	30512856	30384306	MHC-HSK-A100-32-200-C-0-A-AAA1	30523247
	100	32	63	-	200	60	10	171	M16x1	9,9	3	30464692	30512852	30297309	MHC-HSK-A100-32-200-C-0-A-AAA2	30523248
	100	32	63	-	200	60	10	171	M16x1	17,35	4	30464692	30279443	30297310	MHC-HSK-A100-32-200-C-0-A-AAA3	30485489

\* The exact determination of the variant can be found in the selection system for 2-channel system chucks.  
The preferred series is marked with a green .

Dimensions in mm.

Use: To clamp tools with smooth cylindrical shanks according to DIN 1835 form A, DIN 6535 form HA as well as with recesses according to DIN 1835 form B, E and DIN 6535 form HB, HE directly and without reducing sleeve in the clamping diameter. The clamping diameter is designed for a shank tolerance of h6.

Scope of delivery: Tool body, length adjustment screw and coolant unit as assembly. These components can also be ordered separately (see table).

Design: Highest tool life and production quality when using smooth cylindrical shanks according to DIN 1835 form A and DIN 6535 form HA. With a projection length of 2.5xD (max. 50 mm) radial run-out accuracy 3 µm. When using cylindrical shanks with an inclined clamping surface (form E and form HE), the accuracy may be impaired.

Different versions with chip available on request.

Balancing quality: G 2.5 with 25,000 rpm in delivery state.



# 2-channel system MQL shrink chuck ThermoChuck

For automatic tool change, with axial tool length adjustment  
 HSK-A (hollow shank taper form A) shank according to DIN 69893-1

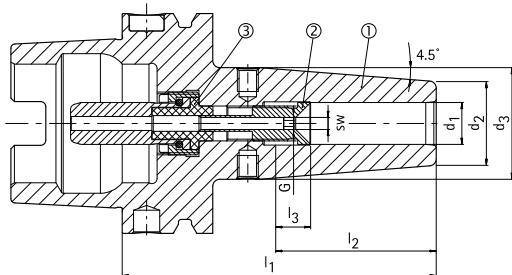

- ① Shrink chuck, HSK, MQL, tool body | BDY
- ② Length adjustment screw, MQL | LS
- ③ Coolant supply unit, MQL, automatic | CU



## Preferred series available from stock

Variant*	HSK-A	Dimensions						G	A <sub>IN</sub> mm <sup>2</sup>	AF	Components			Specification	Order no.
		d <sub>1</sub>	d <sub>2</sub>	d <sub>3</sub>	l <sub>1</sub>	l <sub>2</sub>	l <sub>3</sub>				BDY	LS	CU		
	63	6	21	27	80	36	10	M10x1	1,54	1,5	10083235	30512784	30512203	MTC-HSK-A063-06-080-C-0-A-AAA1	30521882
	63	6	21	27	80	36	10	M10x1	4,52	2	10083235	30384039	30384304	MTC-HSK-A063-06-080-C-0-A-AAA2	30385638
	63	6	21	27	120	36	10	M5	1,54	1,5	30386128	30512804	30512203	MTC-HSK-A063-06-120-C-0-A-AAA1	30521884
	63	6	21	27	120	36	10	M5	4,52	2	30386128	30384040	30384304	MTC-HSK-A063-06-120-C-0-A-AAA2	30385658
	63	8	21	27	80	36	10	M10x1	1,54	1,5	10083236	30512785	30512203	MTC-HSK-A063-08-080-C-0-A-AAA1	30521890
	63	8	21	27	80	36	10	M10x1	4,52	2	10083236	30384043	30384304	MTC-HSK-A063-08-080-C-0-A-AAA2	30385639
	63	8	21	27	120	36	10	M7	1,54	1,5	30386129	30512805	30512203	MTC-HSK-A063-08-120-C-0-A-AAA1	30521892
	63	8	21	27	120	36	10	M7	4,52	2	30386129	30384044	30384304	MTC-HSK-A063-08-120-C-0-A-AAA2	30385659
	63	10	24	32	85	40	10	M10x1	1,54	1,5	10083237	30512786	30512203	MTC-HSK-A063-10-085-C-0-A-AAA1	30521898
	63	10	24	32	85	40	10	M10x1	4,52	2	10083237	30384011	30384304	MTC-HSK-A063-10-085-C-0-A-AAA2	30385640
	63	10	24	32	120	40	10	M8x1	1,54	1,5	30386800	30512806	30512203	MTC-HSK-A063-10-120-C-0-A-AAA1	30521900
	63	10	24	32	120	40	10	M8x1	4,52	2	30386800	30384012	30384304	MTC-HSK-A063-10-120-C-0-A-AAA2	30385660
	63	12	24	32	90	45	10	M10x1	1,54	1,5	10083238	30512791	30512203	MTC-HSK-A063-12-090-C-0-A-AAA1	30521906
	63	12	24	32	90	45	10	M10x1	4,52	2	10083238	30512787	30384304	MTC-HSK-A063-12-090-C-0-A-AAA2	30521908
	63	12	24	32	90	45	10	M10x1	9,9	3	10083238	30279400	30284772	MTC-HSK-A063-12-090-C-0-A-AAA3	30326631
	63	12	24	32	120	45	10	M10x1	1,54	1,5	10096023	30512811	30512203	MTC-HSK-A063-12-120-C-0-A-AAA1	30521910
	63	12	24	32	120	45	10	M10x1	4,52	2	10096023	30512807	30384304	MTC-HSK-A063-12-120-C-0-A-AAA2	30521912
	63	12	24	32	120	45	10	M10x1	9,9	3	10096023	30279402	30284772	MTC-HSK-A063-12-120-C-0-A-AAA3	30326641
	63	14	27	34	90	45	10	M10x1	1,54	1,5	10083239	30512792	30512203	MTC-HSK-A063-14-090-C-0-A-AAA1	30521922
	63	14	27	34	90	45	10	M10x1	4,52	2	10083239	30512788	30384304	MTC-HSK-A063-14-090-C-0-A-AAA2	30521924
	63	14	27	34	90	45	10	M10x1	9,9	3	10083239	30279407	30284772	MTC-HSK-A063-14-090-C-0-A-AAA3	30326632
	63	14	27	34	120	45	10	M10x1	1,54	1,5	30192712	30512813	30512203	MTC-HSK-A063-14-120-C-0-A-AAA1	30521926
	63	14	27	34	120	45	10	M10x1	4,52	2	30192712	30512808	30384304	MTC-HSK-A063-14-120-C-0-A-AAA2	30521928
	63	14	27	34	120	45	10	M10x1	9,9	3	30192712	30279408	30284772	MTC-HSK-A063-14-120-C-0-A-AAA3	30326642
	63	16	27	34	95	48	10	M12x1	1,54	1,5	10083240	30512793	30512203	MTC-HSK-A063-16-095-C-0-A-AAA1	30521938
	63	16	27	34	95	48	10	M12x1	4,52	2	10083240	30512789	30384304	MTC-HSK-A063-16-095-C-0-A-AAA2	30521940
	63	16	27	34	95	48	10	M12x1	9,9	3	10083240	30279413	30284772	MTC-HSK-A063-16-095-C-0-A-AAA3	30326633
	63	16	27	34	120	48	10	M12x1	1,54	1,5	10107287	30512814	30512203	MTC-HSK-A063-16-120-C-0-A-AAA1	30521942
	63	16	27	34	120	48	10	M12x1	4,52	2	10107287	30512809	30384304	MTC-HSK-A063-16-120-C-0-A-AAA2	30521944
	63	16	27	34	120	48	10	M12x1	9,9	3	10107287	30279414	30284772	MTC-HSK-A063-16-120-C-0-A-AAA3	30326643
	63	18	33	42	95	48	10	M12x1	1,54	1,5	10083241	30512794	30512203	MTC-HSK-A063-18-095-C-0-A-AAA1	30521954
	63	18	33	42	95	48	10	M12x1	4,52	2	10083241	30512790	30384304	MTC-HSK-A063-18-095-C-0-A-AAA2	30521956
	63	18	33	42	95	48	10	M12x1	9,9	3	10083241	30279420	30284772	MTC-HSK-A063-18-095-C-0-A-AAA3	30326634
	63	18	33	42	120	48	10	M12x1	1,54	1,5	10107292	30512815	30512203	MTC-HSK-A063-18-120-C-0-A-AAA1	30521958
	63	18	33	42	120	48	10	M12x1	4,52	2	10107292	30512810	30384304	MTC-HSK-A063-18-120-C-0-A-AAA2	30521960
	63	18	33	42	120	48	10	M12x1	9,9	3	10107292	30279422	30284772	MTC-HSK-A063-18-120-C-0-A-AAA3	30326644
	63	20	33	42	100	50	10	M16x1	4,52	2	10083242	30512798	30384304	MTC-HSK-A063-20-100-C-0-A-AAA2	30521970
	63	20	33	42	100	50	10	M16x1	9,9	3	10083242	30512795	30284772	MTC-HSK-A063-20-100-C-0-A-AAA3	30521972
	63	20	33	42	100	50	10	M16x1	17,35	4	10083242	30279429	30279444	MTC-HSK-A063-20-100-C-0-A-AAA4	30326635

**2-channel system MQL shrink chuck ThermoChuck | For automatic tool change, with axial tool length adjustment**  
**HSK-A shank in accordance with DIN 69893-1 | Preferred series available from stock**

Variant*	HSK-A	Dimensions						G	A <sub>N</sub> mm <sup>2</sup>	AF	Components			Specification	Order no.
		d <sub>1</sub>	d <sub>2</sub>	d <sub>3</sub>	l <sub>1</sub>	l <sub>2</sub>	l <sub>3</sub>				BDY	LS	CU		
	63	20	33	42	120	50	10	M16x1	4,52	2	30192716	30512817	30384304	MTC-HSK-A063-20-120-C-0-A-AAA2	30521974
	63	20	33	42	120	50	10	M16x1	9,9	3	30192716	30512816	30284772	MTC-HSK-A063-20-120-C-0-A-AAA3	30521976
	63	20	33	42	120	50	10	M16x1	17,35	4	30192716	30279430	30279444	MTC-HSK-A063-20-120-C-0-A-AAA4	30326645
	63	25	44	53	115	56	10	M16x1	4,52	2	10083243	30512799	30384304	MTC-HSK-A063-25-115-C-0-A-AAA2	30521986
	63	25	44	53	115	56	10	M16x1	9,9	3	10083243	30512796	30284772	MTC-HSK-A063-25-115-C-0-A-AAA3	30521988
	63	25	44	53	115	56	10	M16x1	17,35	4	10083243	30279434	30279444	MTC-HSK-A063-25-115-C-0-A-AAA4	30326636
	63	32	44	53	120	60	10	M16x1	4,52	2	10083244	30512800	30384304	MTC-HSK-A063-32-120-C-0-A-AAA2	30521998
	63	32	44	53	120	60	10	M16x1	9,9	3	10083244	30512797	30284772	MTC-HSK-A063-32-120-C-0-A-AAA3	30522000
	63	32	44	53	120	60	10	M16x1	17,35	4	10083244	30279441	30279444	MTC-HSK-A063-32-120-C-0-A-AAA4	30326637
	100	6	21	27	85	36	10	M10x1	1,54	1,5	10083255	30512784	30521106	MTC-HSK-A100-06-085-C-0-A-AAA1	30522138
	100	6	21	27	85	36	10	M10x1	4,52	2	10083255	30384039	30384306	MTC-HSK-A100-06-085-C-0-A-AAA2	30385790
	100	8	21	27	85	36	10	M10x1	1,54	1,5	10083256	30512785	30521106	MTC-HSK-A100-08-085-C-0-A-AAA1	30522146
	100	8	21	27	85	36	10	M10x1	4,52	2	10083256	30384043	30384306	MTC-HSK-A100-08-085-C-0-A-AAA2	30385791
	100	10	24	32	90	40	10	M10x1	1,54	1,5	10083257	30512786	30521106	MTC-HSK-A100-10-090-C-0-A-AAA1	30522154
	100	10	24	32	90	40	10	M10x1	4,52	2	10083257	30384011	30384306	MTC-HSK-A100-10-090-C-0-A-AAA2	30385792
	100	12	24	32	95	45	10	M10x1	1,54	1,5	10083258	30512791	30521106	MTC-HSK-A100-12-095-C-0-A-AAA1	30522162
	100	12	24	32	95	45	10	M10x1	4,52	2	10083258	30512787	30384306	MTC-HSK-A100-12-095-C-0-A-AAA2	30522164
	100	12	24	32	95	45	10	M10x1	9,9	3	10083258	30279400	30297309	MTC-HSK-A100-12-095-C-0-A-AAA3	30326784
	100	14	27	34	95	45	10	M10x1	1,54	1,5	10083259	30512792	30521106	MTC-HSK-A100-14-095-C-0-A-AAA1	30522178
	100	14	27	34	95	45	10	M10x1	4,52	2	10083259	30512788	30384306	MTC-HSK-A100-14-095-C-0-A-AAA2	30522180
	100	14	27	34	95	45	10	M10x1	9,9	3	10083259	30279407	30297309	MTC-HSK-A100-14-095-C-0-A-AAA3	30326785
	100	16	27	34	100	48	10	M12x1	1,54	1,5	10083260	30512793	30521106	MTC-HSK-A100-16-100-C-0-A-AAA1	30522194
	100	16	27	34	100	48	10	M12x1	4,52	2	10083260	30512789	30384306	MTC-HSK-A100-16-100-C-0-A-AAA2	30522196
	100	16	27	34	100	48	10	M12x1	9,9	3	10083260	30279413	30297309	MTC-HSK-A100-16-100-C-0-A-AAA3	30326786
	100	18	33	42	100	48	10	M12x1	1,54	1,5	10083261	30512794	30521106	MTC-HSK-A100-18-100-C-0-A-AAA1	30522210
	100	18	33	42	100	48	10	M12x1	4,52	2	10083261	30512790	30384306	MTC-HSK-A100-18-100-C-0-A-AAA2	30522212
	100	18	33	42	100	48	10	M12x1	9,9	3	10083261	30279420	30297309	MTC-HSK-A100-18-100-C-0-A-AAA3	30326787
	100	20	33	42	105	50	10	M16x1	4,52	2	10083262	30512798	30384306	MTC-HSK-A100-20-105-C-0-A-AAA2	30522226
	100	20	33	42	105	50	10	M16x1	9,9	3	10083262	30512795	30297309	MTC-HSK-A100-20-105-C-0-A-AAA3	30522228
	100	20	33	42	105	50	10	M16x1	17,35	4	10083262	30279429	30297310	MTC-HSK-A100-20-105-C-0-A-AAA4	30326788
	100	25	44	53	115	56	10	M16x1	4,52	2	10083263	30512799	30384306	MTC-HSK-A100-25-115-C-0-A-AAA2	30522242
	100	25	44	53	115	56	10	M16x1	9,9	3	10083263	30512796	30297309	MTC-HSK-A100-25-115-C-0-A-AAA3	30522244
	100	25	44	53	115	56	10	M16x1	17,35	4	10083263	30279434	30297310	MTC-HSK-A100-25-115-C-0-A-AAA4	30326789
	100	32	44	53	120	60	10	M16x1	4,52	2	10083264	30512800	30384306	MTC-HSK-A100-32-120-C-0-A-AAA2	30522254
	100	32	44	53	120	60	10	M16x1	9,9	3	10083264	30512797	30297309	MTC-HSK-A100-32-120-C-0-A-AAA3	30522256
	100	32	44	53	120	60	10	M16x1	17,35	4	10083264	30279441	30297310	MTC-HSK-A100-32-120-C-0-A-AAA4	30326790

\* The exact determination of the variant can be found in the selection system for 2-channel system chucks.  
 The preferred series is marked with a green .

Dimensions in mm.  
 Scope of delivery: Tool body, length adjustment screw and coolant unit as assembly. These components can also be ordered separately (see table).  
 Design: Permissible run-out variation of the hollow taper shank in relation to the clamping diameter d<sub>1</sub> = 3 μm. The clamping diameter is designed for a shank tolerance of h6.

Different versions with chip available on request.  
 Balancing quality: G 2.5 with 25,000 rpm in delivery state.

# 2-channel system MQL shrink chuck ThermoChuck

For automatic tool change, with axial tool length adjustment  
 HSK-A (hollow shank taper form A) shank according to DIN 69893-1

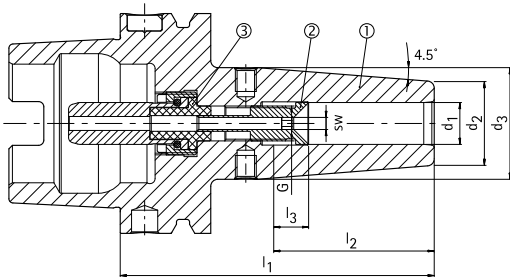

- ① Shrink chuck, HSK, MQL, tool body | BDY
- ② Length adjustment screw, MQL | LS
- ③ Coolant supply unit, MQL, automatic | CU



**Available on request**

Variant*	HSK-A	Dimensions						G	A <sub>IN</sub> mm <sup>2</sup>	AF	Components			Specification	Order no.
		d <sub>1</sub>	d <sub>2</sub>	d <sub>3</sub>	l <sub>1</sub>	l <sub>2</sub>	l <sub>3</sub>				BDY	LS	CU		
	40	6	21	27	80	36	10	M7	1,54	1,5	10083221	30512726	30521102	MTC-HSK-A040-06-080-C-0-A-AAA1	30521750
	40	6	21	27	80	36	10	M7	4,52	2	10083221	30383971	30384302	MTC-HSK-A040-06-080-C-0-A-AAA2	30385554
	40	8	21	27	80	36	10	M7	1,54	1,5	10083222	30512727	30521102	MTC-HSK-A040-08-080-C-0-A-AAA1	30521756
	40	8	21	27	80	36	10	M7	4,52	2	10083222	30383974	30384302	MTC-HSK-A040-08-080-C-0-A-AAA2	30385555
	40	10	24	32	80	40	10	M8x1	1,54	1,5	10083223	30512728	30521102	MTC-HSK-A040-10-080-C-0-A-AAA1	30521762
	40	10	24	32	80	40	10	M8x1	4,52	2	10083223	30383959	30384302	MTC-HSK-A040-10-080-C-0-A-AAA2	30385556
	40	12	24	32	90	45	10	M10x1	1,54	1,5	10083224	30512732	30521102	MTC-HSK-A040-12-090-C-0-A-AAA1	30521768
	40	12	24	32	90	45	10	M10x1	4,52	2	10083224	30512729	30384302	MTC-HSK-A040-12-090-C-0-A-AAA2	30521770
	40	12	24	32	90	45	10	M10x1	9,9	3	10083224	30280050	30297304	MTC-HSK-A040-12-090-C-0-A-AAA3	30326547
	40	14	27	34	90	45	10	M10x1	1,54	1,5	10083225	30512733	30521102	MTC-HSK-A040-14-090-C-0-A-AAA1	30521780
	40	14	27	34	90	45	10	M10x1	4,52	2	10083225	30512730	30384302	MTC-HSK-A040-14-090-C-0-A-AAA2	30521782
	40	14	27	34	90	45	10	M10x1	9,9	3	10083225	30280051	30297304	MTC-HSK-A040-14-090-C-0-A-AAA3	30326548
	40	16	27	34	90	48	10	M12x1	1,54	1,5	10083226	30512734	30521102	MTC-HSK-A040-16-090-C-0-A-AAA1	30521792
	40	16	27	34	90	48	10	M12x1	4,52	2	10083226	30512731	30384302	MTC-HSK-A040-16-090-C-0-A-AAA2	30521794
	40	16	27	34	90	48	10	M12x1	9,9	3	10083226	30280052	30297304	MTC-HSK-A040-16-090-C-0-A-AAA3	30326549
	50	6	21	27	80	36	10	M8x1	1,54	1,5	10083227	30512753	30521103	MTC-HSK-A050-06-080-C-0-A-AAA1	30521804
	50	6	21	27	80	36	10	M8x1	4,52	2	10083227	30384009	30384303	MTC-HSK-A050-06-080-C-0-A-AAA2	30385590
	50	8	21	27	80	36	10	M8x1	1,54	1,5	10083228	30512754	30521103	MTC-HSK-A050-08-080-C-0-A-AAA1	30521810
	50	8	21	27	80	36	10	M8x1	4,52	2	10083228	30384010	30384303	MTC-HSK-A050-08-080-C-0-A-AAA2	30385591
	50	10	24	32	85	40	10	M8x1	1,54	1,5	10083229	30512755	30521103	MTC-HSK-A050-10-085-C-0-A-AAA1	30521816
	50	10	24	32	85	40	10	M8x1	4,52	2	10083229	30384004	30384303	MTC-HSK-A050-10-085-C-0-A-AAA2	30385592
	50	12	24	32	90	45	10	M10x1	1,54	1,5	10083230	30512791	30521103	MTC-HSK-A050-12-090-C-0-A-AAA1	30521822
	50	12	24	32	90	45	10	M10x1	4,52	2	10083230	30512787	30384303	MTC-HSK-A050-12-090-C-0-A-AAA2	30521824
	50	12	24	32	90	45	10	M10x1	9,9	3	10083230	30279400	30297305	MTC-HSK-A050-12-090-C-0-A-AAA3	30326583
	50	14	27	34	90	45	10	M10x1	1,54	1,5	10083231	30512792	30521103	MTC-HSK-A050-14-090-C-0-A-AAA1	30521834
	50	14	27	34	90	45	10	M10x1	4,52	2	10083231	30512788	30384303	MTC-HSK-A050-14-090-C-0-A-AAA2	30521836
	50	14	27	34	90	45	10	M10x1	9,9	3	10083231	30279407	30297305	MTC-HSK-A050-14-090-C-0-A-AAA3	30326584
	50	16	27	34	95	48	10	M12x1	1,54	1,5	10083232	30512793	30521103	MTC-HSK-A050-16-095-C-0-A-AAA1	30521846
	50	16	27	34	95	48	10	M12x1	4,52	2	10083232	30512789	30384303	MTC-HSK-A050-16-095-C-0-A-AAA2	30521848
	50	16	27	34	95	48	10	M12x1	9,9	3	10083232	30279413	30297305	MTC-HSK-A050-16-095-C-0-A-AAA3	30326585
	50	18	33	42	95	48	10	M12x1	1,54	1,5	10083233	30512794	30521103	MTC-HSK-A050-18-095-C-0-A-AAA1	30521858
	50	18	33	42	95	48	10	M12x1	4,52	2	10083233	30512790	30384303	MTC-HSK-A050-18-095-C-0-A-AAA2	30521860
	50	18	33	42	95	48	10	M12x1	9,9	3	10083233	30279420	30297305	MTC-HSK-A050-18-095-C-0-A-AAA3	30326586
	50	20	33	42	100	50	10	M16x1	4,52	2	10083234	30512798	30384303	MTC-HSK-A050-20-100-C-0-A-AAA2	30521870
	50	20	33	42	100	50	10	M16x1	9,9	3	10083234	30512795	30297305	MTC-HSK-A050-20-100-C-0-A-AAA3	30521872
	50	20	33	42	100	50	10	M16x1	17,35	4	10083234	30279429	30297306	MTC-HSK-A050-20-100-C-0-A-AAA4	30326587
	63	6	21	27	160	36	10	M5	1,54	1,5	30386130	30512819	30512203	MTC-HSK-A063-06-160-C-0-A-AAA1	30521886
	63	6	21	27	160	36	10	M5	4,52	2,0	30386130	30384041	30384304	MTC-HSK-A063-06-160-C-0-A-AAA2	30385674
	63	6	21	27	200	36	10	M5	1,54	1,5	30386132	30512839	30512203	MTC-HSK-A063-06-200-C-0-A-AAA1	30521888

2-channel system MQL shrink chuck ThermoChuck | For automatic tool change, with axial tool length adjustment  
 HSK-A shank in accordance with DIN 69893-1 | Available on request

Variant*	HSK-A	Dimensions						G	A <sub>N</sub> mm <sup>2</sup>	AF	Components			Specification	Order no.
		d <sub>1</sub>	d <sub>2</sub>	d <sub>3</sub>	l <sub>1</sub>	l <sub>2</sub>	l <sub>3</sub>				BDY	LS	CU		
	63	6	21	27	200	36	10	M5	4,52	2,0	30386132	30384042	30384304	MTC-HSK-A063-06-200-C-0-A-AAA2	30385694
	63	8	21	27	160	36	10	M7	1,54	1,5	30386131	30512820	30512203	MTC-HSK-A063-08-160-C-0-A-AAA1	30521894
	63	8	21	27	160	36	10	M7	4,52	2,0	30386131	30384045	30384304	MTC-HSK-A063-08-160-C-0-A-AAA2	30385675
	63	8	21	27	200	36	10	M7	1,54	1,5	30386133	30512840	30512203	MTC-HSK-A063-08-200-C-0-A-AAA1	30521896
	63	8	21	27	200	36	10	M7	4,52	2,0	30386133	30384046	30384304	MTC-HSK-A063-08-200-C-0-A-AAA2	30385695
	63	10	24	32	160	40	10	M8x1	1,54	1,5	30386802	30512821	30512203	MTC-HSK-A063-10-160-C-0-A-AAA1	30521902
	63	10	24	32	160	40	10	M8x1	4,52	2,0	30386802	30384013	30384304	MTC-HSK-A063-10-160-C-0-A-AAA2	30385676
	63	10	24	32	200	40	10	M8x1	1,54	1,5	30386134	30512841	30512203	MTC-HSK-A063-10-200-C-0-A-AAA1	30521904
	63	10	24	32	200	40	10	M8x1	4,52	2,0	30386134	30384014	30384304	MTC-HSK-A063-10-200-C-0-A-AAA2	30385696
	63	12	24	32	160	45	10	M10x1	1,54	1,5	30197953	30512826	30512203	MTC-HSK-A063-12-160-C-0-A-AAA1	30521914
	63	12	24	32	160	45	10	M10x1	4,52	2,0	30197953	30512822	30384304	MTC-HSK-A063-12-160-C-0-A-AAA2	30521916
	63	12	24	32	160	45	10	M10x1	9,90	3,0	30197953	30279404	30284772	MTC-HSK-A063-12-160-C-0-A-AAA3	30326649
	63	12	24	32	200	45	10	M10x1	1,54	1,5	10107285	30512846	30512203	MTC-HSK-A063-12-200-C-0-A-AAA1	30521918
	63	12	24	32	200	45	10	M10x1	4,52	2,0	10107285	30512842	30384304	MTC-HSK-A063-12-200-C-0-A-AAA2	30521920
	63	12	24	32	200	45	10	M10x1	9,90	3,0	10107285	30279405	30284772	MTC-HSK-A063-12-200-C-0-A-AAA3	30326659
	63	14	27	34	160	45	10	M10x1	1,54	1,5	10096025	30512827	30512203	MTC-HSK-A063-14-160-C-0-A-AAA1	30521930
	63	14	27	34	160	45	10	M10x1	4,52	2,0	10096025	30512823	30384304	MTC-HSK-A063-14-160-C-0-A-AAA2	30521932
	63	14	27	34	160	45	10	M10x1	9,90	3,0	10096025	30279410	30284772	MTC-HSK-A063-14-160-C-0-A-AAA3	30326650
	63	14	27	34	200	45	10	M10x1	1,54	1,5	10096026	30512847	30512203	MTC-HSK-A063-14-200-C-0-A-AAA1	30521934
	63	14	27	34	200	45	10	M10x1	4,52	2,0	10096026	30512843	30384304	MTC-HSK-A063-14-200-C-0-A-AAA2	30521936
	63	14	27	34	200	45	10	M10x1	9,90	3,0	10096026	30279412	30284772	MTC-HSK-A063-14-200-C-0-A-AAA3	30326660
	63	16	27	34	160	48	10	M12x1	1,54	1,5	10107288	30512828	30512203	MTC-HSK-A063-16-160-C-0-A-AAA1	30521946
	63	16	27	34	160	48	10	M12x1	4,52	2,0	10107288	30512824	30384304	MTC-HSK-A063-16-160-C-0-A-AAA2	30521948
	63	16	27	34	160	48	10	M12x1	9,90	3,0	10107288	30279416	30284772	MTC-HSK-A063-16-160-C-0-A-AAA3	30326651
	63	16	27	34	200	48	10	M12x1	1,54	1,5	10107289	30512848	30512203	MTC-HSK-A063-16-200-C-0-A-AAA1	30521950
	63	16	27	34	200	48	10	M12x1	4,52	2,0	10107289	30512844	30384304	MTC-HSK-A063-16-200-C-0-A-AAA2	30521952
	63	16	27	34	200	48	10	M12x1	9,90	3,0	10107289	30279418	30284772	MTC-HSK-A063-16-200-C-0-A-AAA3	30326661
	63	18	33	42	160	48	10	M12x1	1,54	1,5	10096027	30512829	30512203	MTC-HSK-A063-18-160-C-0-A-AAA1	30521962
	63	18	33	42	160	48	10	M12x1	4,52	2,0	10096027	30512825	30384304	MTC-HSK-A063-18-160-C-0-A-AAA2	30521964
	63	18	33	42	160	48	10	M12x1	9,90	3,0	10096027	30279423	30284772	MTC-HSK-A063-18-160-C-0-A-AAA3	30326652
	63	18	33	42	200	48	10	M12x1	1,54	1,5	10107293	30512849	30512203	MTC-HSK-A063-18-200-C-0-A-AAA1	30521966
	63	18	33	42	200	48	10	M12x1	4,52	2,0	10107293	30512845	30384304	MTC-HSK-A063-18-200-C-0-A-AAA2	30521968
	63	18	33	42	200	48	10	M12x1	9,90	3,0	10107293	30279427	30284772	MTC-HSK-A063-18-200-C-0-A-AAA3	30326662
	63	20	33	42	160	50	10	M16x1	4,52	2,0	10107294	30512833	30384304	MTC-HSK-A063-20-160-C-0-A-AAA2	30521978
	63	20	33	42	160	50	10	M16x1	9,90	3,0	10107294	30512830	30284772	MTC-HSK-A063-20-160-C-0-A-AAA3	30521980
	63	20	33	42	160	50	10	M16x1	17,35	4,0	10107294	30279432	30279444	MTC-HSK-A063-20-160-C-0-A-AAA4	30326653
	63	20	33	42	200	50	10	M16x1	4,52	2,0	10107295	30512853	30384304	MTC-HSK-A063-20-200-C-0-A-AAA2	30521982
	63	20	33	42	200	50	10	M16x1	9,90	3,0	10107295	30512850	30284772	MTC-HSK-A063-20-200-C-0-A-AAA3	30521984
	63	20	33	42	200	50	10	M16x1	17,35	4,0	10107295	30279433	30279444	MTC-HSK-A063-20-200-C-0-A-AAA4	30326663
	63	25	44	53	160	56	10	M16x1	4,52	2,0	10107296	30512834	30384304	MTC-HSK-A063-25-160-C-0-A-AAA2	30521990
	63	25	44	53	160	56	10	M16x1	9,90	3,0	10107296	30512831	30284772	MTC-HSK-A063-25-160-C-0-A-AAA3	30521992
	63	25	44	53	160	56	10	M16x1	17,35	4,0	10107296	30279435	30279444	MTC-HSK-A063-25-160-C-0-A-AAA4	30326654
	63	25	44	53	200	56	10	M16x1	4,52	2,0	10107297	30512854	30384304	MTC-HSK-A063-25-200-C-0-A-AAA2	30521994
	63	25	44	53	200	56	10	M16x1	9,90	3,0	10107297	30512851	30284772	MTC-HSK-A063-25-200-C-0-A-AAA3	30521996
	63	25	44	53	200	56	10	M16x1	17,35	4,0	10107297	30279436	30279444	MTC-HSK-A063-25-200-C-0-A-AAA4	30326664
	63	32	44	53	160	60	10	M16x1	4,52	2,0	10107298	30512835	30384304	MTC-HSK-A063-32-160-C-0-A-AAA2	30522002
	63	32	44	53	160	60	10	M16x1	9,90	3,0	10107298	30512832	30284772	MTC-HSK-A063-32-160-C-0-A-AAA3	30522004
	63	32	44	53	160	60	10	M16x1	17,35	4,0	10107298	30279442	30279444	MTC-HSK-A063-32-160-C-0-A-AAA4	30326655
	63	32	44	53	200	60	10	M16x1	4,52	2,0	10107299	30512856	30384304	MTC-HSK-A063-32-200-C-0-A-AAA2	30522006
	63	32	44	53	200	60	10	M16x1	9,90	3,0	10107299	30512852	30284772	MTC-HSK-A063-32-200-C-0-A-AAA3	30522008
	63	32	44	53	200	60	10	M16x1	17,35	4,0	10107299	30279443	30279444	MTC-HSK-A063-32-200-C-0-A-AAA4	30326665
	80	6	21	27	85	36	10	M10x1	1,54	1,5	10083245	30512784	30521104	MTC-HSK-A080-06-085-C-0-A-AAA1	30522010
	80	6	21	27	85	36	10	M10x1	4,52	2,0	10083245	30384039	30384305	MTC-HSK-A080-06-085-C-0-A-AAA2	30385714
	80	8	21	27	85	36	10	M10x1	1,54	1,5	10083246	30512785	30521104	MTC-HSK-A080-08-085-C-0-A-AAA1	30522018
	80	8	21	27	85	36	10	M10x1	4,52	2,0	10083246	30384043	30384305	MTC-HSK-A080-08-085-C-0-A-AAA2	30385715
	80	10	24	32	90	40	10	M10x1	1,54	1,5	10083247	30512786	30521104	MTC-HSK-A080-10-090-C-0-A-AAA1	30522026

**2-channel system MQL shrink chuck ThermoChuck | For automatic tool change, with axial tool length adjustment**  
**HSK-A shank in accordance with DIN 69893-1 | Available on request**

Variant*	HSK-A	Dimensions						G	A <sub>N</sub>	AF	Components			Specification	Order no.
		d <sub>1</sub>	d <sub>2</sub>	d <sub>3</sub>	l <sub>1</sub>	l <sub>2</sub>	l <sub>3</sub>				mm <sup>2</sup>	BDY	LS		
	80	10	24	32	90	40	10	M10x1	4,52	2	10083247	30384011	30384305	MTC-HSK-A080-10-090-C-0-A-AAA2	30385716
	80	12	24	32	95	45	10	M10x1	1,54	1,5	10083248	30512791	30521104	MTC-HSK-A080-12-095-C-0-A-AAA1	30522034
	80	12	24	32	95	45	10	M10x1	4,52	2	10083248	30512787	30384305	MTC-HSK-A080-12-095-C-0-A-AAA2	30522036
	80	12	24	32	95	45	10	M10x1	9,9	3	10083248	30279400	30297307	MTC-HSK-A080-12-095-C-0-A-AAA3	30326708
	80	14	27	34	95	45	10	M10x1	1,54	1,5	10083249	30512792	30521104	MTC-HSK-A080-14-095-C-0-A-AAA1	30522050
	80	14	27	34	95	45	10	M10x1	4,52	2	10083249	30512788	30384305	MTC-HSK-A080-14-095-C-0-A-AAA2	30522052
	80	14	27	34	95	45	10	M10x1	9,9	3	10083249	30279407	30297307	MTC-HSK-A080-14-095-C-0-A-AAA3	30326709
	80	16	27	34	100	48	10	M12x1	1,54	1,5	10083250	30512793	30521104	MTC-HSK-A080-16-100-C-0-A-AAA1	30522066
	80	16	27	34	100	48	10	M12x1	4,52	2	10083250	30512789	30384305	MTC-HSK-A080-16-100-C-0-A-AAA2	30522068
	80	16	27	34	100	48	10	M12x1	9,9	3	10083250	30279413	30297307	MTC-HSK-A080-16-100-C-0-A-AAA3	30326710
	80	18	33	42	100	48	10	M12x1	1,54	1,5	10083251	30512794	30521104	MTC-HSK-A080-18-100-C-0-A-AAA1	30522082
	80	18	33	42	100	48	10	M12x1	4,52	2	10083251	30512790	30384305	MTC-HSK-A080-18-100-C-0-A-AAA2	30522084
	80	18	33	42	100	48	10	M12x1	9,9	3	10083251	30279420	30297307	MTC-HSK-A080-18-100-C-0-A-AAA3	30326711
	80	20	33	42	105	50	10	M16x1	4,52	2	10083252	30512798	30384305	MTC-HSK-A080-20-105-C-0-A-AAA2	30522098
	80	20	33	42	105	50	10	M16x1	9,9	3	10083252	30512795	30297307	MTC-HSK-A080-20-105-C-0-A-AAA3	30522100
	80	20	33	42	105	50	10	M16x1	17,35	4	10083252	30279429	30297308	MTC-HSK-A080-20-105-C-0-A-AAA4	30326712
	80	25	44	53	115	56	10	M16x1	4,52	2	10083253	30512799	30384305	MTC-HSK-A080-25-115-C-0-A-AAA2	30522114
	80	25	44	53	115	56	10	M16x1	9,9	3	10083253	30512796	30297307	MTC-HSK-A080-25-115-C-0-A-AAA3	30522116
	80	25	44	53	115	56	10	M16x1	17,35	4	10083253	30279434	30297308	MTC-HSK-A080-25-115-C-0-A-AAA4	30326713
	80	32	44	53	120	60	10	M16x1	4,52	2	10083254	30512800	30384305	MTC-HSK-A080-32-120-C-0-A-AAA2	30522126
	80	32	44	53	120	60	10	M16x1	9,9	3	10083254	30512797	30297307	MTC-HSK-A080-32-120-C-0-A-AAA3	30522128
	80	32	44	53	120	60	10	M16x1	17,35	4	10083254	30279441	30297308	MTC-HSK-A080-32-120-C-0-A-AAA4	30326714
	100	6	21	27	120	36	10	M5	1,54	1,5	30386144	30512804	30521106	MTC-HSK-A100-06-120-C-0-A-AAA1	30522140
	100	6	21	27	120	36	10	M5	4,52	2	30386144	30384040	30384306	MTC-HSK-A100-06-120-C-0-A-AAA2	30385810
	100	6	21	27	160	36	10	M5	1,54	1,5	30386147	30512819	30521106	MTC-HSK-A100-06-160-C-0-A-AAA1	30522142
	100	6	21	27	160	36	10	M5	4,52	2	30386147	30384041	30384306	MTC-HSK-A100-06-160-C-0-A-AAA2	30385826
	100	6	21	27	200	36	10	M5	1,54	1,5	30386150	30512839	30521106	MTC-HSK-A100-06-200-C-0-A-AAA1	30522144
	100	6	21	27	200	36	10	M5	4,52	2	30386150	30384042	30384306	MTC-HSK-A100-06-200-C-0-A-AAA2	30385847
	100	8	21	27	120	36	10	M7	1,54	1,5	30386145	30512805	30521106	MTC-HSK-A100-08-120-C-0-A-AAA1	30522148
	100	8	21	27	120	36	10	M7	4,52	2	30386145	30384044	30384306	MTC-HSK-A100-08-120-C-0-A-AAA2	30385811
	100	8	21	27	160	36	10	M7	1,54	1,5	30386148	30512820	30521106	MTC-HSK-A100-08-160-C-0-A-AAA1	30522150
	100	8	21	27	160	36	10	M7	4,52	2	30386148	30384045	30384306	MTC-HSK-A100-08-160-C-0-A-AAA2	30385827
	100	8	21	27	200	36	10	M7	1,54	1,5	30386151	30512840	30521106	MTC-HSK-A100-08-200-C-0-A-AAA1	30522152
	100	8	21	27	200	36	10	M7	4,52	2	30386151	30384046	30384306	MTC-HSK-A100-08-200-C-0-A-AAA2	30385848
	100	10	24	32	120	40	10	M8x1	1,54	1,5	30386146	30512806	30521106	MTC-HSK-A100-10-120-C-0-A-AAA1	30522156
	100	10	24	32	120	40	10	M8x1	4,52	2	30386146	30384012	30384306	MTC-HSK-A100-10-120-C-0-A-AAA2	30385812
	100	10	24	32	160	40	10	M8x1	1,54	1,5	30386149	30512821	30521106	MTC-HSK-A100-10-160-C-0-A-AAA1	30522158
	100	10	24	32	160	40	10	M8x1	4,52	2	30386149	30384013	30384306	MTC-HSK-A100-10-160-C-0-A-AAA2	30385828
	100	10	24	32	200	40	10	M8x1	1,54	1,5	30386152	30512841	30521106	MTC-HSK-A100-10-200-C-0-A-AAA1	30522160
	100	10	24	32	200	40	10	M8x1	4,52	2	30386152	30384014	30384306	MTC-HSK-A100-10-200-C-0-A-AAA2	30385849
	100	12	24	32	120	45	10	M10x1	1,54	1,5	30253151	30512811	30521106	MTC-HSK-A100-12-120-C-0-A-AAA1	30522166
	100	12	24	32	120	45	10	M10x1	4,52	2	30253151	30512807	30384306	MTC-HSK-A100-12-120-C-0-A-AAA2	30522168
	100	12	24	32	120	45	10	M10x1	9,9	3	30253151	30279402	30297309	MTC-HSK-A100-12-120-C-0-A-AAA3	30326794
	100	12	24	32	160	45	10	M10x1	1,54	1,5	30302825	30512826	30521106	MTC-HSK-A100-12-160-C-0-A-AAA1	30522170
	100	12	24	32	160	45	10	M10x1	4,52	2	30302825	30512822	30384306	MTC-HSK-A100-12-160-C-0-A-AAA2	30522172
	100	12	24	32	160	45	10	M10x1	9,9	3	30302825	30279404	30297309	MTC-HSK-A100-12-160-C-0-A-AAA3	30326802
	100	12	24	32	200	45	10	M10x1	1,54	1,5	30253152	30512846	30521106	MTC-HSK-A100-12-200-C-0-A-AAA1	30522174
	100	12	24	32	200	45	10	M10x1	4,52	2	30253152	30512842	30384306	MTC-HSK-A100-12-200-C-0-A-AAA2	30522176
	100	12	24	32	200	45	10	M10x1	9,9	3	30253152	30279405	30297309	MTC-HSK-A100-12-200-C-0-A-AAA3	30326812
	100	14	27	34	120	45	10	M10x1	1,54	1,5	30254306	30512813	30521106	MTC-HSK-A100-14-120-C-0-A-AAA1	30522182
	100	14	27	34	120	45	10	M10x1	4,52	2	30254306	30512808	30384306	MTC-HSK-A100-14-120-C-0-A-AAA2	30522184
	100	14	27	34	120	45	10	M10x1	9,9	3	30254306	30279408	30297309	MTC-HSK-A100-14-120-C-0-A-AAA3	30326795
	100	14	27	34	160	45	10	M10x1	1,54	1,5	30302826	30512827	30521106	MTC-HSK-A100-14-160-C-0-A-AAA1	30522186
	100	14	27	34	160	45	10	M10x1	4,52	2	30302826	30512823	30384306	MTC-HSK-A100-14-160-C-0-A-AAA2	30522188
	100	14	27	34	160	45	10	M10x1	9,9	3	30302826	30279410	30297309	MTC-HSK-A100-14-160-C-0-A-AAA3	30326803
	100	14	27	34	200	45	10	M10x1	1,54	1,5	30303050	30512847	30521106	MTC-HSK-A100-14-200-C-0-A-AAA1	30522190

Continued on next page.

**2-channel system MQL shrink chuck ThermoChuck | For automatic tool change, with axial tool length adjustment**  
**HSK-A shank in accordance with DIN 69893-1 | Available on request**

Variant*	HSK-A	Dimensions						G	A <sub>N</sub> mm <sup>2</sup>	AF	Components			Specification	Order no.
		d <sub>1</sub>	d <sub>2</sub>	d <sub>3</sub>	l <sub>1</sub>	l <sub>2</sub>	l <sub>3</sub>				BDY	LS	CU		
100	14	27	34	200	45	10	M10x1	4,52	2	30303050	30512843	30384306	MTC-HSK-A100-14-200-C-0-A-AAA2	30522192	
100	14	27	34	200	45	10	M10x1	9,9	3	30303050	30279412	30297309	MTC-HSK-A100-14-200-C-0-A-AAA3	30326813	
100	16	27	34	120	48	10	M12x1	1,54	1,5	30302821	30512814	30521106	MTC-HSK-A100-16-120-C-0-A-AAA1	30522198	
100	16	27	34	120	48	10	M12x1	4,52	2	30302821	30512809	30384306	MTC-HSK-A100-16-120-C-0-A-AAA2	30522200	
100	16	27	34	120	48	10	M12x1	9,9	3	30302821	30279414	30297309	MTC-HSK-A100-16-120-C-0-A-AAA3	30326796	
100	16	27	34	160	48	10	M12x1	1,54	1,5	30302827	30512828	30521106	MTC-HSK-A100-16-160-C-0-A-AAA1	30522202	
100	16	27	34	160	48	10	M12x1	4,52	2	30302827	30512824	30384306	MTC-HSK-A100-16-160-C-0-A-AAA2	30522204	
100	16	27	34	160	48	10	M12x1	9,9	3	30302827	30279416	30297309	MTC-HSK-A100-16-160-C-0-A-AAA3	30326804	
100	16	27	34	200	48	10	M12x1	1,54	1,5	30302831	30512848	30521106	MTC-HSK-A100-16-200-C-0-A-AAA1	30522206	
100	16	27	34	200	48	10	M12x1	4,52	2	30302831	30512844	30384306	MTC-HSK-A100-16-200-C-0-A-AAA2	30522208	
100	16	27	34	200	48	10	M12x1	9,9	3	30302831	30279418	30297309	MTC-HSK-A100-16-200-C-0-A-AAA3	30326814	
100	18	33	42	120	48	10	M12x1	1,54	1,5	30253155	30512815	30521106	MTC-HSK-A100-18-120-C-0-A-AAA1	30522214	
100	18	33	42	120	48	10	M12x1	4,52	2	30253155	30512810	30384306	MTC-HSK-A100-18-120-C-0-A-AAA2	30522216	
100	18	33	42	120	48	10	M12x1	9,9	3	30253155	30279422	30297309	MTC-HSK-A100-18-120-C-0-A-AAA3	30326797	
100	18	33	42	160	48	10	M12x1	1,54	1,5	10096879	30512829	30521106	MTC-HSK-A100-18-160-C-0-A-AAA1	30522218	
100	18	33	42	160	48	10	M12x1	4,52	2	10096879	30512825	30384306	MTC-HSK-A100-18-160-C-0-A-AAA2	30522220	
100	18	33	42	160	48	10	M12x1	9,9	3	10096879	30279423	30297309	MTC-HSK-A100-18-160-C-0-A-AAA3	30326805	
100	18	33	42	200	48	10	M12x1	1,54	1,5	10107134	30512849	30521106	MTC-HSK-A100-18-200-C-0-A-AAA1	30522222	
100	18	33	42	200	48	10	M12x1	4,52	2	10107134	30512845	30384306	MTC-HSK-A100-18-200-C-0-A-AAA2	30522224	
100	18	33	42	200	48	10	M12x1	9,9	3	10107134	30279427	30297309	MTC-HSK-A100-18-200-C-0-A-AAA3	30326815	
100	20	33	42	120	50	10	M16x1	4,52	2	30302822	30512817	30384306	MTC-HSK-A100-20-120-C-0-A-AAA2	30522230	
100	20	33	42	120	50	10	M16x1	9,9	3	30302822	30512816	30297309	MTC-HSK-A100-20-120-C-0-A-AAA3	30522232	
100	20	33	42	120	50	10	M16x1	17,35	4	30302822	30279430	30297310	MTC-HSK-A100-20-120-C-0-A-AAA4	30326798	
100	20	33	42	160	50	10	M16x1	4,52	2	10096880	30512833	30384306	MTC-HSK-A100-20-160-C-0-A-AAA2	30522234	
100	20	33	42	160	50	10	M16x1	9,9	3	10096880	30512830	30297309	MTC-HSK-A100-20-160-C-0-A-AAA3	30522236	
100	20	33	42	160	50	10	M16x1	17,35	4	10096880	30279432	30297310	MTC-HSK-A100-20-160-C-0-A-AAA4	30326806	
100	20	33	42	200	50	10	M16x1	4,52	2	30302832	30512853	30384306	MTC-HSK-A100-20-200-C-0-A-AAA2	30522238	
100	20	33	42	200	50	10	M16x1	9,9	3	30302832	30512850	30297309	MTC-HSK-A100-20-200-C-0-A-AAA3	30522240	
100	20	33	42	200	50	10	M16x1	17,35	4	30302832	30279433	30297310	MTC-HSK-A100-20-200-C-0-A-AAA4	30326816	
100	25	44	53	160	56	10	M16x1	1,54	2	30258455	30512834	30384306	MTC-HSK-A100-25-160-C-0-A-AAA2	30522246	
100	25	44	53	160	56	10	M16x1	4,52	3	30258455	30512831	30297309	MTC-HSK-A100-25-160-C-0-A-AAA3	30522248	
100	25	44	53	160	56	10	M16x1	9,9	4	30258455	30279435	30297310	MTC-HSK-A100-25-160-C-0-A-AAA4	30326807	
100	25	44	53	200	56	10	M16x1	1,54	2	30302833	30512854	30384306	MTC-HSK-A100-25-200-C-0-A-AAA2	30522250	
100	25	44	53	200	56	10	M16x1	4,52	3	30302833	30512851	30297309	MTC-HSK-A100-25-200-C-0-A-AAA3	30522252	
100	25	44	53	200	56	10	M16x1	9,9	4	30302833	30279436	30297310	MTC-HSK-A100-25-200-C-0-A-AAA4	30326817	
100	32	44	53	160	60	10	M16x1	4,52	2	30303048	30512835	30384306	MTC-HSK-A100-32-160-C-0-A-AAA2	30522258	
100	32	44	53	160	60	10	M16x1	9,9	3	30303048	30512832	30297309	MTC-HSK-A100-32-160-C-0-A-AAA3	30522260	
100	32	44	53	160	60	10	M16x1	17,35	4	30303048	30279442	30297310	MTC-HSK-A100-32-160-C-0-A-AAA4	30326808	
100	32	44	53	200	60	10	M16x1	4,52	2	30302834	30512856	30384306	MTC-HSK-A100-32-200-C-0-A-AAA2	30522262	
100	32	44	53	200	60	10	M16x1	9,9	3	30302834	30512852	30297309	MTC-HSK-A100-32-200-C-0-A-AAA3	30522264	
100	32	44	53	200	60	10	M16x1	17,35	4	30302834	30279443	30297310	MTC-HSK-A100-32-200-C-0-A-AAA4	30326818	

\* The exact determination of the variant can be found in the selection system for 2-channel system chucks.  
 The preferred series is marked with a green .

Dimensions in mm.  
 Scope of delivery: Tool body, length adjustment screw and coolant unit as assembly. These components can also be ordered separately (see table).  
 Design: Permissible run-out variation of the hollow taper shank to the clamping diameter d<sub>1</sub> = 3 µm. The clamping diameter is designed for a shank tolerance of h6.

Different versions with chip available on request.  
 Balancing quality: G 2.5 with 25,000 rpm in delivery state.

# Milling cutter arbor

Mechanical tool clamping

With enlarged face connection diameter according to DIN 69882-3

HSK-A (hollow shank taper form A) shank according to DIN 69893-1

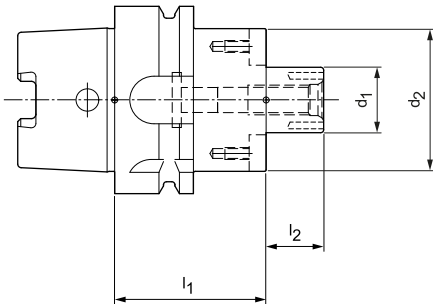

HSK-A shank with decentralised coolant delivery | Available on request

HSK-A	Dimensions				G	Specification	Order no.
	$d_1$	$d_2$	$l_1$	$l_2$			
63	16	38	50	17	M8	MCA-HSK-A063-16-050-1-0-W	31312171
63	16	38	100	17	M8	MCA-HSK-A063-16-100-1-0-W	31312176
63	16	38	160	17	M8	MCA-HSK-A063-16-160-1-0-W	31312191
63	22	48	50	19	M10	MCA-HSK-A063-22-050-1-0-W	31312172
63	22	48	100	19	M10	MCA-HSK-A063-22-100-1-0-W	31312177
63	22	48	160	19	M10	MCA-HSK-A063-22-160-1-0-W	31312192
63	27	60	60	21	M12	MCA-HSK-A063-27-060-1-0-W	31312173
63	27	60	100	21	M12	MCA-HSK-A063-27-100-1-0-W	31312178
63	27	60	160	21	M12	MCA-HSK-A063-27-160-1-0-W	31312193
63	32	78	60	24	M16	MCA-HSK-A063-32-060-1-0-W	31312174
63	32	78	100	24	M16	MCA-HSK-A063-32-100-1-0-W	31312179
63	32	78	160	24	M16	MCA-HSK-A063-32-160-1-0-W	31312194
63	40	89	60	27	M20	MCA-HSK-A063-40-060-1-0-W	31312175
63	40	89	100	27	M20	MCA-HSK-A063-40-100-1-0-W	31312190
100	16	38	50	17	M8	MCA-HSK-A100-16-050-1-0-W	31312195
100	16	38	100	17	M8	MCA-HSK-A100-16-100-1-0-W	31312200
100	16	38	160	17	M8	MCA-HSK-A100-16-160-1-0-W	31312205
100	22	48	50	19	M10	MCA-HSK-A100-22-050-1-0-W	31312196
100	22	48	100	19	M10	MCA-HSK-A100-22-100-1-0-W	31312201
100	22	48	160	19	M10	MCA-HSK-A100-22-160-1-0-W	31312206
100	27	60	50	21	M12	MCA-HSK-A100-27-050-1-0-W	31312197
100	27	60	100	21	M12	MCA-HSK-A100-27-100-1-0-W	31312202
100	27	60	160	21	M12	MCA-HSK-A100-27-160-1-0-W	31312207
100	32	78	50	24	M16	MCA-HSK-A100-32-050-1-0-W	31312198
100	32	78	100	24	M16	MCA-HSK-A100-32-100-1-0-W	31312203
100	32	78	160	24	M16	MCA-HSK-A100-32-160-1-0-W	31312208
100	40	89	60	27	M20	MCA-HSK-A100-40-060-1-0-W	31312199
100	40	89	100	27	M20	MCA-HSK-A100-40-100-1-0-W	31312204
100	40	89	160	27	M20	MCA-HSK-A100-40-160-1-0-W	31312209
100	60	140	70	40	M30	MCA-HSK-A100-60-070-1-0-W	31354755

Dimensions in mm.

Additional dimensions available upon request.

Scope of delivery: With screwed-on key blocks and milling cutter clamping screw according to DIN 6367. Without coolant tube.

Design: Permissible run-out variation on the taper in relation to the arbor diameter  $d_1 = 6 \mu\text{m}$ .

Note: Milling cutter clamping screw supplied without internal cooling. Coolant tubes and assembly tool, see "CLAMPING" catalogue.

Balancing quality: G 2.5 with 25,000 rpm in delivery state.

# Milling cutter arbor

Mechanical tool clamping

With enlarged face connection diameter according to DIN 69882-3

SK shank according to ISO 7388-1 Form AD/AF

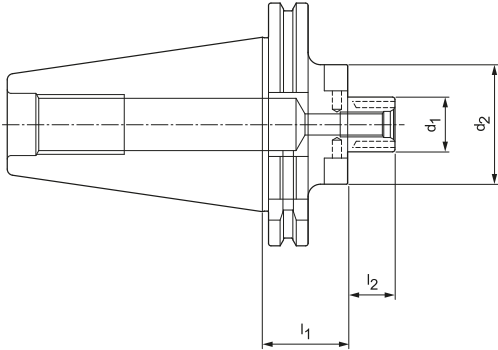

SK shank with decentralised coolant delivery | Available on request

Steep taper	Dimensions				G	Specification	Order no.
	$d_1$	$d_2$	$l_1$	$l_2$			
40	16	38	35	17	M8	MCA-SK040-16-035-3-0-W	31369046
40	22	48	35	19	M10	MCA-SK040-22-035-3-0-W	31369047
40	27	50	35	21	M12	MCA-SK040-27-035-3-0-W	31369048
50	22	48	35	19	M10	MCA-SK050-22-035-3-0-W	31312229
50	22	48	100	19	M10	MCA-SK050-22-100-3-0-W	31312233
50	22	48	160	19	M10	MCA-SK050-22-160-3-0-W	31312237
50	27	60	35	21	M12	MCA-SK050-27-035-3-0-W	31312230
50	27	60	100	21	M12	MCA-SK050-27-100-3-0-W	31312234
50	27	60	160	21	M12	MCA-SK050-27-160-3-0-W	31312238
50	32	78	35	24	M16	MCA-SK050-32-035-3-0-W	31312231
50	32	78	100	24	M16	MCA-SK050-32-100-3-0-W	31312235
50	32	78	160	24	M16	MCA-SK050-32-160-3-0-W	31312239
50	40	89	50	27	M20	MCA-SK050-40-050-3-0-W	31312232
50	40	89	100	27	M20	MCA-SK050-40-100-3-0-W	31312236
50	40	89	160	27	M20	MCA-SK050-40-160-3-0-W	31312240

Dimensions in mm.

Additional dimensions available upon request.

Scope of delivery: With screwed-on key blocks and milling cutter clamping screw according to DIN 6367. Without pull stud.

Design: Permissible run-out variation on the taper in relation to the arbor diameter  $d_1 = 6 \mu\text{m}$ .

Basic setting Form AD, if Form AF is required, please specify this when placing your order.

Note: Milling cutter clamping screw supplied without internal cooling. Coolant tubes and assembly tool, see "CLAMPING" catalogue.

Balancing quality: G 2.5 with 25,000 rpm in delivery state.



# Milling cutter arbor

Mechanical tool clamping

With enlarged face connection diameter according to DIN 69882-3

Shank BT according to ISO 7388-2 Form JD/JF (JIS B 6339)

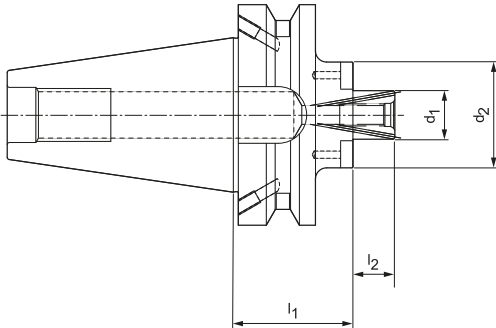

BT shank with decentralised coolant delivery | Available on request

BT	Dimensions				G	Specification	Order no.
	$d_1$	$d_2$	$l_1$	$l_2$			
50	22	48	55	19	M8	MCA-BT050-22-055-3-0-W	31312241
50	22	48	100	19	M8	MCA-BT050-22-100-3-0-W	31312245
50	27	60	55	21	M10	MCA-BT050-27-055-3-0-W	31312242
50	27	60	100	21	M10	MCA-BT050-27-100-3-0-W	31312246
50	32	78	55	24	M12	MCA-BT050-32-055-3-0-W	31312243
50	32	78	100	24	M12	MCA-BT050-32-100-3-0-W	31312247
50	40	89	55	27	M16	MCA-BT050-40-055-3-0-W	31312244

Dimensions in mm.

Additional dimensions available upon request.

Scope of delivery: With screwed-on key blocks and milling cutter clamping screw according to DIN 6367. Without pull stud.

Design: Permissible run-out variation on the taper in relation to the arbor diameter  $d_1 = 6 \mu\text{m}$ .

Basic setting Form JD; if Form JF is required, please state with the order.

Note: Milling cutter clamping screw supplied without internal cooling. Coolant tubes and assembly tool, see "CLAMPING" catalogue.

Balancing quality: G 2.5 with 25,000 rpm in delivery status.



# TECHNICAL APPENDIX

---

Notes on application, handling, and cutting data recommendations.



Antriebsauslastung - Anzeige 59.5  
Service Info 01/07  
DATE: 03.04.11  
TIME: 10:20:25  
MEL 4 Betriebsart aktiv  
NC/UKS/4\_1471\_SPM\_STANDARDPROG/SPM\_2\_2  
782012  
RESET UKS

Position [mm]  
X 226.533  
Y 33.867  
Z 46.362  
0.000°  
0.000°  
T.S.M  
NPV setzen  
Nullp. Werkst  
Werkz. messen  
Position  
Planfräsen  
Schwenken  
Zoom Istwert

T.S.M  
NPV setzen  
Nullp. Werkst  
Werkz. messen  
Position  
Planfräsen  
Schwenken

Planfräsen  
Schwenken

# TECHNICAL APPENDIX

## Bore machining

---

Drilling from solid .....	
Tritan-Drill-Alu .....	222
MEGA-Speed-Drill-Titan .....	222
MEGA-Deep-Drill-Steel .....	224
Reaming .....	
FixReam 500 Plus .....	228
FixReam 700 .....	230
NC machine reamer .....	232
Boring .....	
Boring tools with indexable inserts .....	234

## Milling

---

Milling with fixed cutting edges .....	
OptiMill-Alu-Wave .....	236
OptiMill-Diamond .....	238
OptiMill-Tro-Inox .....	244
OptiMill-Titan-HPC .....	244
Milling cutters with replaceable cutting edges .....	
NeoMill-T-Finish .....	246
FaceMill-Diamond-ES .....	247
NeoMill-Alu-QBig .....	248
NeoMill-Titan .....	253
TGMill-4-Shell .....	254
Radial indexable insert SPGN .....	256

## General technical information

---

Pictograms .....	258
MAPAL machining groups .....	261

# Cutting data recommendations for solid carbide drills

Feed and cutting speed

## Tritan-Drill-Alu | SCD681

MMG*		Workpiece material	Strength/hardness [N/mm <sup>2</sup> ] [HRC]
N	N1	N1.1 Aluminium, unalloyed and alloyed < 3% Si	
		N1.2 Aluminium, alloyed ≤ 7% Si	
		N1.3 Aluminium, alloyed > 7 - 12% Si	
		N1.4 Aluminium, alloyed > 12% Si	
	N2	N2.1 Copper, unalloyed and low alloyed	< 300
		N2.2 Copper, alloyed	> 300
		N2.3 Brass, bronze, gunmetal	< 1,200

## MEGA-Speed-Drill-Titan | SCD961

MMG*		Workpiece material	Strength/hardness [N/mm <sup>2</sup> ] [HRC]
S	S1	S1.1 Titanium, titanium alloys	< 400
		S2.1 Titanium, titanium alloys	< 1,200
	S2	S2.2 Titanium, titanium alloys	> 1,200

	Cutting speed $v_c$ [m/min]				Feed $f$ [mm] for drill diameter					
	Internal cooling	External cooling	MQL	Air	4.00	5.50	7.50	10.50	14.50	20.00
	<b>300</b>	<b>200</b>	<b>250</b>		0.42	0.53	0.66	0.82	1.00	1.15
	<b>250</b>	<b>180</b>	<b>200</b>		0.53	0.68	0.85	1.07	1.31	1.52
	<b>220</b>	<b>150</b>	<b>180</b>		0.53	0.68	0.85	1.07	1.31	1.52
	<b>180</b>	<b>120</b>	<b>150</b>		0.53	0.68	0.85	1.07	1.31	1.52
	<b>140</b>	<b>100</b>			0.42	0.53	0.66	0.82	1.00	1.15
	<b>120</b>	<b>90</b>			0.53	0.68	0.85	1.07	1.31	1.52
	<b>200</b>	<b>160</b>	<b>160</b>	<b>120</b>	0.46	0.61	0.79	1.02	1.26	1.48

	Cutting speed $v_c$ [m/min]				Feed $f$ [mm] for drill diameter					
	Internal cooling	External cooling	MQL	Air	3.00	4.50	6.50	9.50	14.00	20.00
	<b>40</b>	<b>25</b>			0.077	0.103	0.134	0.173	0.219	0.259
	<b>30</b>	<b>20</b>			0.066	0.088	0.115	0.149	0.188	0.222
	<b>25</b>	<b>15</b>			0.055	0.073	0.095	0.124	0.157	0.185

The specified cutting data are guide values.  
 The optimum data for the respective machining task should be determined during the test or machining.

# Cutting data recommendations for solid carbide drills

Feed and cutting speed

## MEGA-Deep-Drill-Steel | SCD701

MMG*		Workpiece material	Strength/hardness [N/mm <sup>2</sup> ] [HRC]
P	P1	P1.1 Structural, machining, case hardened and tempering steels, unalloyed	< 700
		P1.2 Structural, machining, case hardened and tempering steels, unalloyed	< 1,200
	P2	P2.1 Nitriding, hardening and tempering steels, alloyed	< 900
		P2.2 Nitriding, hardening and tempering steels, alloyed	< 1,400
	P3	P3.1 Tool, bearing, spring and high-speed steels**	< 800
		P3.2 Tool, bearing, spring and high-speed steels**	< 1,000
		P3.3 Tool, bearing, spring and high-speed steels**	< 1,500
	P5	P5.1 Cast steel	
K	K1	K1.1 Cast iron with lamellar graphite (grey cast iron), GJL	< 300
		K2.1 Cast iron with spheroidal graphite, GJS	< 500
	K2	K2.2 Cast iron with spheroidal graphite, GJS	≤ 800
		K2.3 Cast iron with spheroidal graphite, GJS	> 800
	K3	K3.1 Cast iron with vermicular graphite, GJV; malleable cast iron, GJM	< 500
		K3.2 Cast iron with vermicular graphite, GJV; malleable cast iron, GJM	> 500

\* MAPAL machining groups

\*\* If the alloy parts Cr, Mo, Ni, V, W are in total > 8%, select the next highest MAPAL machining group.



	Cutting speed $v_c$ [m/min]		Feed $f$ [mm] for drill diameter					
	Internal cooling	MQL	3.00	4.00	6.00	8.00	12.00	16.00
	<b>100</b>	<b>90</b>	0.16	0.19	0.24	0.30	0.40	0.48
	<b>90</b>	<b>75</b>	0.20	0.24	0.31	0.38	0.48	0.60
	<b>100</b>	<b>85</b>	0.19	0.23	0.29	0.36	0.46	0.57
	<b>70</b>	<b>60</b>	0.16	0.19	0.24	0.29	0.39	0.45
	<b>75</b>	<b>65</b>	0.17	0.20	0.26	0.32	0.42	0.51
	<b>60</b>	<b>55</b>	0.14	0.17	0.22	0.27	0.35	0.42
	<b>60</b>	<b>50</b>	0.12	0.14	0.18	0.21	0.28	0.32
	<b>100</b>	<b>85</b>	0.19	0.23	0.29	0.36	0.46	0.57
	<b>120</b>	<b>85</b>	0.21	0.28	0.37	0.48	0.62	0.80
	<b>160</b>	<b>120</b>	0.22	0.27	0.35	0.45	0.58	0.74
	<b>100</b>	<b>75</b>	0.20	0.24	0.31	0.39	0.52	0.63
	<b>60</b>	<b>50</b>	0.14	0.17	0.22	0.27	0.35	0.42
	<b>90</b>	<b>80</b>	0.21	0.26	0.34	0.42	0.55	0.68
	<b>80</b>	<b>70</b>	0.18	0.22	0.28	0.34	0.45	0.54

**Guide values für coolant pressure and quantity**

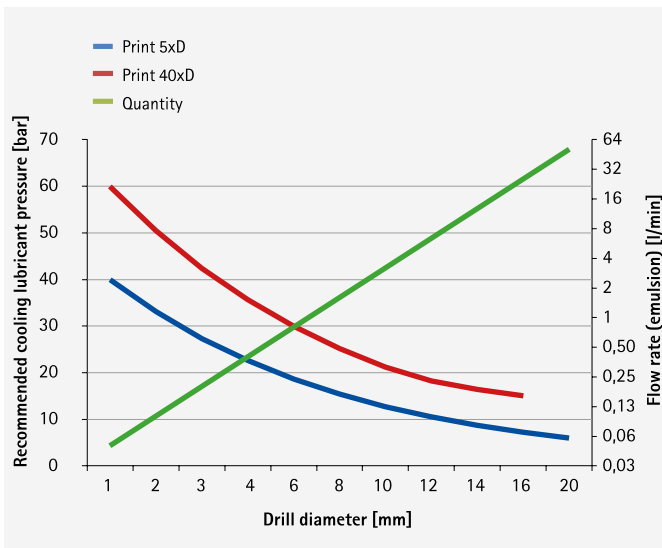

**System pressures for MQL for deep drills**

<b>MQL systems</b>	<b>Supply pressure</b>
<b>Single-channel systems</b>	<b>up to 16 bar</b>
Recommended supply pressure	5–6 bar
High pressure for deep drilling < nominal Ø 12 mm	8–10 bar
<b>Two-channel systems</b>	<b>up to 10 bar</b>
Recommended supply pressure	5–6 bar
High pressure for deep drilling < nominal Ø 6 mm	8–10 bar

The specified cutting data are guide values.  
The optimum data for the respective machining task should be determined during the test or machining.

# Deep drilling in three steps

## 1 Making a pilot bore

### MEGA-Drill-Steel-Plus [SCD600, SCD601]

For general drilling conditions



### MEGA-Step-Drill-Steel-Plus [SCD590, SCD591]

For general drilling conditions incl. 90° countersink



### MEGA-Speed-Drill-Steel [SCD621]

For general drilling conditions



#### Info:

Select nominal  $\varnothing$  that is 0.02 mm larger.

#### Example:

Pilot tool; MEGA-Speed-Drill-Steel,  
nominal  $\varnothing$  5.02 mm

Subsequent tool: MEGA-Deep-Drill-Steel,  
nominal  $\varnothing$  5.00 mm

### MEGA-180°-Drill [SCD231]

For difficult drilling conditions



## 2 Deep drilling up to 30xD

### Entry into the pilot bore:

- Commissioning at max. 300 rpm and  $v_f = 1,000$  mm/min
- Without coolant – up to 1 mm before the bottom of the bore of the pilot bore
- Switch on coolant  
→ cooling lubricant = 10–40 bar/MQL
- Spot drilling with specified cutting data according to table

#### Info:

Further method for spot drilling with MEGA-Deep-Drill-Steel: Spot drilling with 50% feed, linear acceleration to 100% feed up to drilling depth of 4xD

- **Deep drilling up to 30xD in one process, without chip removal cycles**

### Running out:

- Run out at max. 300 rpm and double the feed ( $2x v_f$ )
- Switch off coolant

## 3 Deep drilling up to 40xD

### Entry into the 30xD bore:

- Commissioning at max. 300 rpm and  $v_f = 1,000$  mm/min
- Without coolant – up to 1 mm before the bottom of the bore of the 30xD bore
- Switch on coolant  
→ cooling lubricant = 10–40 bar/MQL
- Spot drilling with specified cutting data according to table

#### Info:

Further method for spot drilling with MEGA-Deep-Drill-Steel: Spot drilling with 50% feed, linear acceleration to 100% feed up to drilling depth of 32xD

- **Deep drilling up to 40xD in one go, without chip removal cycles**

### Running out:

- Run out at max. 300 rpm and double the feed ( $2x v_f$ )
- Switch off coolant

### Selecting the suitable pilot drill

- The nominal diameter of the pilot drill must match the nominal diameter of the MEGA-Deep-Drill-Steel.
- The point angle and diameter tolerances are matched for optimal functionality as well as for the interaction of pilot drill and deep drill.

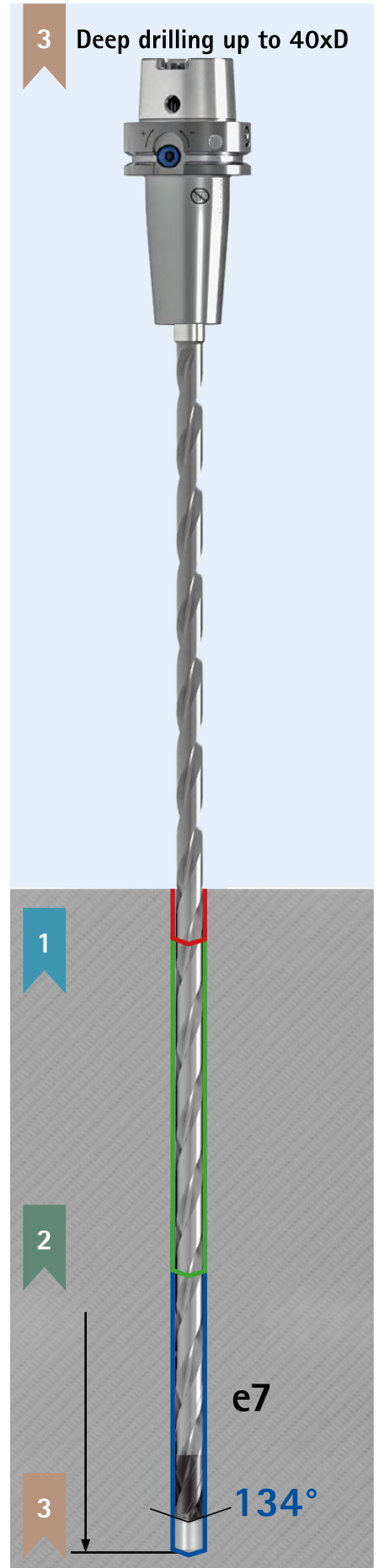
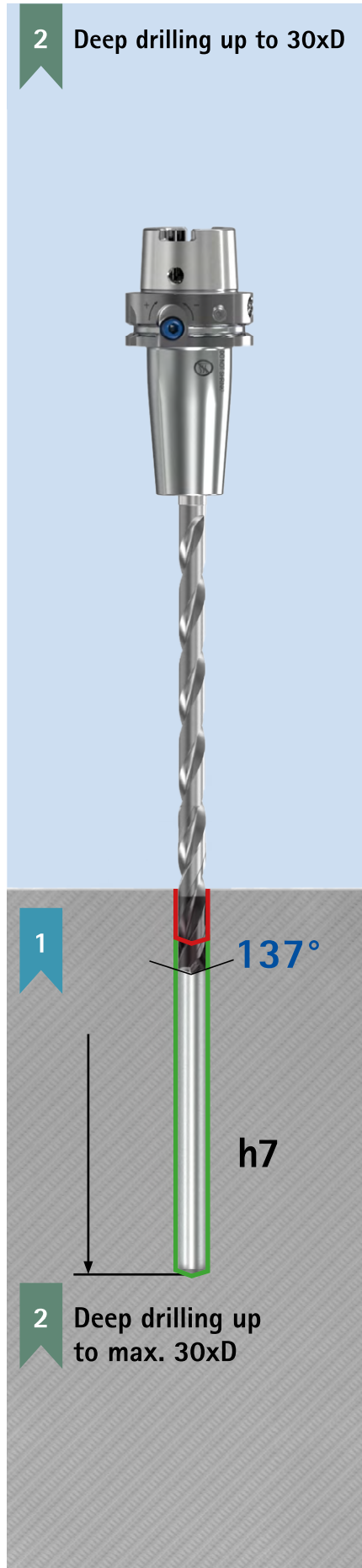
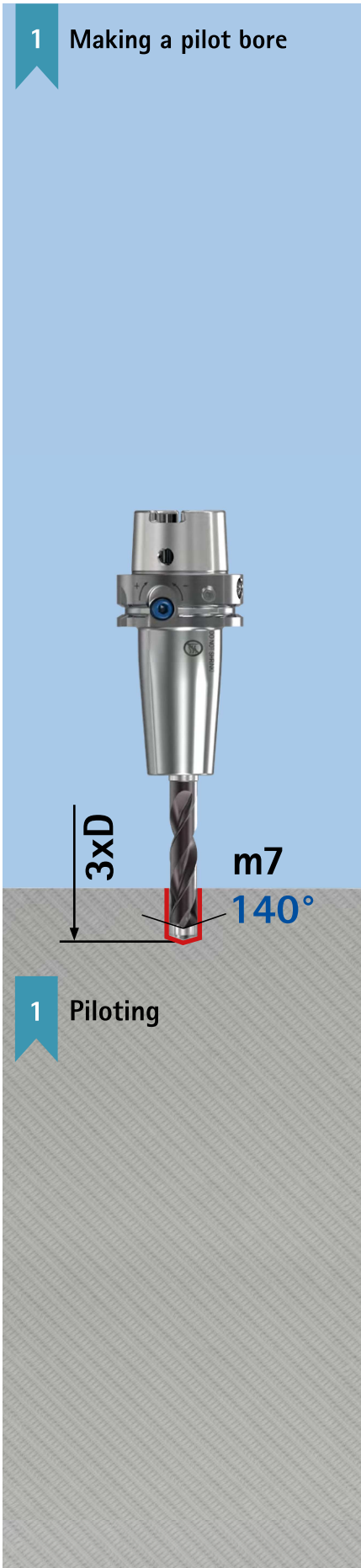

# Cutting data recommendation for FixReam 500 Plus

Feed and cutting speed

## FixReam 500 Plus

MMG*		Workpiece material	Strength/hardness [N/mm <sup>2</sup> ] [HRC]	
P	P1	P1.1 Structural, machining, case hardened and tempering steels, unalloyed	< 700	
		P1.2 Structural, machining, case hardened and tempering steels, unalloyed	< 1,200	
	P2	P2.1 Nitriding, hardening and tempering steels, alloyed	< 900	
		P2.2 Nitriding, hardening and tempering steels, alloyed	< 1,400	
	P3	P3.1 Tool, bearing, spring and high-speed steels**	< 800	
		P3.2 Tool, bearing, spring and high-speed steels**	< 1,000	
		P3.3 Tool, bearing, spring and high-speed steels**	< 1,500	
	P4	P4.1 Stainless steels, ferritic and martensitic		
P5	P5.1 Cast steel			
P6	P6.1 Stainless cast steels, ferritic and martensitic			
M	M1	M1.1 Stainless steels, austenitic	< 700	
		M1.2 Stainless steels, ferritic/austenitic (duplex)	< 1,000	
	M2	M2.1 Stainless cast steel, austenitic	< 700	
		M3.1 Stainless cast steel, ferritic/austenitic (duplex)	< 1,000	
K	K1	K1.1 Cast iron with lamellar graphite (grey cast iron), GJL	< 300	
		K2.1 Cast iron with spheroidal graphite, GJS	< 500	
		K2.2 Cast iron with spheroidal graphite, GJS	≤ 800	
	K2	K2.3 Cast iron with spheroidal graphite, GJS	> 800	
		K3	K3.1 Cast iron with vermicular graphite, GJV; malleable cast iron, GJM	< 500
			K3.2 Cast iron with vermicular graphite, GJV; malleable cast iron, GJM	> 500
N	N1	N1.1 Aluminium, unalloyed and alloyed < 3% Si		
		N1.2 Aluminium, alloyed ≤ 7% Si		
		N1.3 Aluminium, alloyed > 7 - 12% Si		
		N1.4 Aluminium, alloyed > 12% Si	< 300	
S	S1	S1.1 Titanium, titanium alloys	< 400	
		S2.1 Titanium, titanium alloys	> 1,200	
	S2	S2.2 Titanium, titanium alloys	< 1,200	
		S3	S3.1 Nickel, unalloyed and alloyed	> 900
	S3.2 Nickel, unalloyed and alloyed		> 900	
	S4	S4.1 High-temperature super alloy, Ni-, Co-, and Fe-based		
	S5	S5.1 Wolfram and molybdenum alloy		
H	H1	H1.1 Hardened steel / Cast steel	< 44	
		H1.2 Hardened steel / Cast steel	< 55	

\* MAPAL machining groups

\*\* If the alloy parts Cr, Mo, Ni, V, W are in total > 8%, select the next highest MAPAL machining group.

vc	Feed $f_z$ [mm/z] and stock removal $a_p$ [mm] for tool diameter											
	< 5.701 (Z=4) [mm]		> 5.701-6.2 (Z=6) [mm]		> 6.2-8 (Z=6) [mm]		> 8-12 (Z=6) [mm]		> 12-16.2 (Z=6) [mm]		> 16.2-20.2 (Z=6) [mm]	
	f	a	f	a	f	a	f	a	f	a	f	a
180	0.15	0.10	0.17	0.10	0.20	0.10	0.20	0.15	0.25	0.20	0.30	0.20
150	0.10	0.10	0.13	0.10	0.17	0.10	0.17	0.15	0.20	0.20	0.25	0.20
180	0.15	0.10	0.17	0.10	0.20	0.10	0.20	0.15	0.25	0.20	0.30	0.20
140	0.08	0.10	0.10	0.10	0.13	0.10	0.13	0.15	0.17	0.20	0.20	0.20
180	0.15	0.10	0.17	0.10	0.20	0.10	0.20	0.15	0.25	0.20	0.30	0.20
160	0.10	0.10	0.13	0.10	0.17	0.10	0.17	0.15	0.20	0.20	0.25	0.20
140	0.08	0.10	0.10	0.10	0.13	0.10	0.13	0.15	0.17	0.20	0.20	0.20
40	0.03	0.05	0.03	0.10	0.05	0.10	0.07	0.10	0.08	0.20	0.10	0.20
140	0.08	0.10	0.10	0.10	0.13	0.10	0.13	0.15	0.17	0.20	0.20	0.20
40	0.03	0.05	0.03	0.10	0.05	0.10	0.07	0.10	0.08	0.20	0.10	0.20
50	0.04	0.05	0.03	0.10	0.07	0.10	0.08	0.10	0.12	0.20	0.13	0.20
40	0.04	0.05	0.03	0.10	0.07	0.10	0.08	0.10	0.12	0.20	0.13	0.20
50	0.04	0.05	0.03	0.10	0.07	0.10	0.08	0.10	0.12	0.20	0.13	0.20
40	0.04	0.05	0.03	0.10	0.07	0.10	0.08	0.10	0.12	0.20	0.13	0.20
100	0.13	0.10	0.20	0.10	0.20	0.10	0.25	0.20	0.30	0.20	0.30	0.20
100	0.13	0.10	0.20	0.10	0.20	0.10	0.25	0.20	0.30	0.20	0.30	0.20
100	0.13	0.10	0.20	0.10	0.20	0.10	0.25	0.20	0.30	0.20	0.30	0.20
100	0.13	0.10	0.20	0.10	0.20	0.10	0.25	0.20	0.30	0.20	0.30	0.20
100	0.13	0.10	0.20	0.10	0.20	0.10	0.25	0.20	0.30	0.20	0.30	0.20
100	0.13	0.10	0.20	0.10	0.20	0.10	0.25	0.20	0.30	0.20	0.30	0.20
250	0.13	0.10	0.10	0.10	0.13	0.10	0.22	0.20	0.25	0.30	0.30	0.30
250	0.13	0.10	0.10	0.10	0.13	0.10	0.22	0.20	0.25	0.30	0.30	0.30
250	0.13	0.10	0.10	0.10	0.13	0.10	0.22	0.20	0.25	0.30	0.30	0.30
250	0.13	0.10	0.10	0.10	0.13	0.10	0.22	0.20	0.25	0.30	0.30	0.30
20	0.05	0.05	0.05	0.05	0.05	0.10	0.05	0.10	0.05	0.15	0.05	0.20
20	0.05	0.05	0.05	0.05	0.05	0.10	0.05	0.10	0.05	0.15	0.05	0.20
20	0.05	0.05	0.05	0.05	0.05	0.10	0.05	0.10	0.05	0.15	0.05	0.20
20	0.05	0.05	0.05	0.05	0.05	0.10	0.05	0.10	0.05	0.15	0.05	0.20
20	0.05	0.05	0.05	0.05	0.05	0.10	0.05	0.10	0.05	0.15	0.05	0.20
20	0.05	0.05	0.05	0.05	0.05	0.10	0.05	0.10	0.05	0.15	0.05	0.20
20	0.05	0.05	0.05	0.05	0.05	0.10	0.05	0.10	0.05	0.15	0.05	0.20
10	0.02	0.05	0.02	0.05	0.02	0.05	0.02	0.10	0.03	0.10	0.03	0.20
10	0.02	0.05	0.02	0.05	0.02	0.05	0.02	0.10	0.03	0.10	0.03	0.20

The specified cutting data are guide values.  
 The optimum data for the respective machining task should be determined during the test or machining.

# Cutting data recommendations for FixReam 700

Feed and cutting speed

## FXR700 | FXR702 | FXR703 | FXR705

Cutting material: CU111 | Lead: LA1G | LB1G

MMG*		Workpiece material	Strength/ Hardness [N/mm <sup>2</sup> ] [HRC]	Cutting speed v <sub>c</sub> [m/min]	Feed f <sub>z</sub> (mm/z) for tool diameter
				Internal cooling	z 6 9.900 - 32.200
P	P1	P1.1 Structural, machining, case hardened and tempering steels, unalloyed	< 700	120	0.150
		P1.2 Structural, machining, case hardened and tempering steels, unalloyed	< 1,200	120	0.150
	P2	P2.1 Nitriding, hardening and tempering steels, alloyed	< 900	110	0.150
		P2.2 Nitriding, hardening and tempering steels, alloyed	< 1,400	110	0.120
	P3	P3.1 Tool, bearing, spring and high-speed steels**	< 800	110	0.150
		P3.2 Tool, bearing, spring and high-speed steels**	< 1,000	120	0.150
P3.3 Tool, bearing, spring and high-speed steels**		< 1,500	120		
K	K1	K1.1 Cast iron with lamellar graphite (grey cast iron), GJL	< 300	120	0.200
		K2.1 Cast iron with spheroidal graphite, GJS	< 500	120	0.180
	K2	K2.2 Cast iron with spheroidal graphite, GJS	≤ 800		
		K2.3 Cast iron with spheroidal graphite, GJS	> 800		

\* MAPAL machining groups

\*\* If the alloy parts Cr, Mo, Ni, V, W are in total > 8%, select the next highest MAPAL machining group.

The specified cutting data are guide values.

The optimum data for the respective machining task should be determined during the test or machining.

# Lead geometries, rake angle and tolerances for FixReam series

## Lead geometry and rake angle

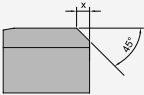
Series	Geometry	Lead geometry			
		Name	Ø area	Lead length x	Geometry
FixReam 500 Plus		MJ	3.701 - 4.200 mm	0.30 mm	45°
		MM	4.201 - 4.700 mm	0.40 mm	
		MQ	4.701 - 20.200 mm	0.55 mm	

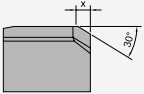
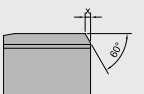
Series	Geometry	Lead geometry			
		Name	Ø area	Lead length x	Geometry
FixReam 700		LA	9.900 - 11.700 mm	0.80 mm	30°
			11.701 - 32.200 mm	1.00 mm	
		LB	9.900 - 32.000 mm	0.25 mm	60°

## Tolerances for the G variant/fixed variant FXRXX

Cutting material	Tolerance
<b>Uncoated</b> CU111	-0.003
<b>Coated (layer thickness 0.8–1 µm)</b> HP622	-0.004
<b>Coated (layer thickness 2–4 µm)</b> HP141 HP900	-0.005

## Chip shape / rake angle

Rake angle	
Name	Angle
1G	6°

## G variant

The G variant indicates the tool diameter of the reamer with our manufacturing tolerances. The manufacturing tolerances depend on the cutting material (see permissible smallest tolerances for the G variant).

# Cutting data recommendation for NC machine reamers

Feed and cutting speed

## NC machine reamer MDR500 | MDR510

MMG*	Workpiece material	Strength/hardness [N/mm <sup>2</sup> ] [HRC]	
P	P1.1 Structural, machining, case hardened and tempering steels, unalloyed	< 700	
	P1.2 Structural, machining, case hardened and tempering steels, unalloyed	< 1,200	
	P2.1 Nitriding, hardening and tempering steels, alloyed	< 900	
	P2.2 Nitriding, hardening and tempering steels, alloyed	< 1,400	
	P3.1 Tool, bearing, spring and high-speed steels**	< 800	
	P3.2 Tool, bearing, spring and high-speed steels**	< 1,000	
	P3.3 Tool, bearing, spring and high-speed steels**	< 1,500	
	P4.1 Stainless steels, ferritic and martensitic		
	P5.1 Cast steel		
	P6.1 Stainless cast steels, ferritic and martensitic		
	K	K1.1 Cast iron with lamellar graphite (grey cast iron), GJL	< 300
		K2.1 Cast iron with spheroidal graphite, GJS	< 500
K2.2 Cast iron with spheroidal graphite, GJS		≤ 800	
K2.3 Cast iron with spheroidal graphite, GJS		> 800	
K3.1 Cast iron with vermicular graphite, GJV; malleable cast iron, GJM		< 500	
K3.2 Cast iron with vermicular graphite, GJV; malleable cast iron, GJM		> 500	
N	N1.1 Aluminium, unalloyed and alloyed < 3% Si		
	N1.2 Aluminium, alloyed ≤ 7% Si		
	N1.3 Aluminium, alloyed > 7 - 12% Si		
	N1.4 Aluminium, alloyed > 12% Si		
	N2.1 Copper, unalloyed and low alloyed	< 300	
	N2.2 Copper, alloyed	> 300	
	N2.3 Brass, bronze, gunmetal	< 1,200	
	N4.1 Plastic, thermoplastics		
	N4.2 Plastic, duroplastics		
	N4.3 Plastic, foam materials		

\* MAPAL machining groups

\*\* If the alloy parts Cr, Mo, Ni, V, W are in total > 8%, select the next highest MAPAL machining group.



Feed $f_z$ [mm/z] and stock removal $a_p$ [mm] for tool diameter									
< 1.701 (Z=3) [mm]			< 2.651 (Z=4) [mm]			> 2.651-13 (Z=6) [mm]			
$v_c$	f	a	$v_c$	f	a	$v_c$	f	a	
20	0.03	0.10	20	0.04	0.15	20	0.03	0.20	
12	0.03	0.10	12	0.04	0.15	12	0.03	0.20	
15	0.03	0.10	15	0.04	0.15	15	0.03	0.20	
12	0.03	0.10	12	0.04	0.15	12	0.03	0.20	
15	0.03	0.10	15	0.04	0.15	15	0.03	0.20	
12	0.03	0.10	12	0.04	0.15	12	0.03	0.20	
10	0.03	0.10	10	0.04	0.15	10	0.03	0.20	
15	0.03	0.10	15	0.04	0.15	15	0.03	0.20	
18	0.03	0.10	18	0.05	0.15	18	0.05	0.20	
15	0.03	0.10	15	0.05	0.15	15	0.05	0.20	
10	0.03	0.10	10	0.05	0.15	10	0.05	0.20	
10	0.03	0.10	10	0.05	0.15	10	0.05	0.20	
15	0.03	0.10	15	0.05	0.15	15	0.05	0.20	
10	0.03	0.10	10	0.05	0.15	10	0.05	0.20	
40	0.05	0.10	40	0.05	0.15	40	0.04	0.20	
25	0.05	0.10	25	0.05	0.15	25	0.04	0.20	
30	0.05	0.10	30	0.05	0.15	30	0.04	0.20	
30	0.05	0.10	30	0.05	0.15	30	0.04	0.20	
30	0.05	0.10	30	0.05	0.15	30	0.04	0.20	
40	0.05	0.10	40	0.05	0.15	40	0.04	0.20	
40	0.05	0.10	40	0.05	0.15	40	0.04	0.20	
40	0.05	0.10	40	0.05	0.15	40	0.04	0.20	

The specified cutting data are guide values.  
 The optimum data for the respective machining task should be determined during the test or machining.

# Cutting data recommendation for boring tools with indexable inserts

Cutting speed

MMG*	Workpiece material			Strength/ Hardness [N/mm <sup>2</sup> ] [HRC]	Carbide		
					PVD-coated		
					HP616	HP880	HP885
					v <sub>c</sub> [m/min]	v <sub>c</sub> [m/min]	v <sub>c</sub> [m/min]
P	P1	P1.1	Structural, machining, case hardened and tempering steels, unalloyed	< 700		100-220	
		P1.2	Structural, machining, case hardened and tempering steels, unalloyed	< 1,200		100-220	
	P2	P2.1	Nitriding, hardening and tempering steels, alloyed	< 900		100-220	
		P2.2	Nitriding, hardening and tempering steels, alloyed	< 1,400		100-200	
	P3	P3.1	Tool, bearing, spring and high-speed steels**	< 800		80-200	
		P3.2	Tool, bearing, spring and high-speed steels**	< 1,000		80-200	
		P3.3	Tool, bearing, spring and high-speed steels**	< 1,500			
	P4	P4.1	Stainless steels, ferritic and martensitic			80-200	
	P5	P5.1	Cast steel				
	P6	P6.1	Stainless cast steels, ferritic and martensitic			80-200	
M	M1	M1.1	Stainless cast steel, ferritic and martensitic	< 700		150-220	100-180
		M1.2	Stainless steels, ferritic/austenitic (duplex)	< 1,000		120-200	100-160
	M2	M2.1	Stainless cast steel, austenitic	< 700		100-180	80-150
	M3	M3.1	Stainless cast steel, ferritic/austenitic (duplex)	< 1,000		100-180	60-140
K	K1	K1.1	Cast iron with lamellar graphite (grey cast iron), GJL	< 300			
		K2.1	Cast iron with spheroidal graphite, GJS	< 500			
		K2.2	Cast iron with spheroidal graphite, GJS	≤ 800			
	K2	K2.3	Cast iron with spheroidal graphite, GJS	> 800			
		K3.1	Cast iron with vermicular graphite, GJV; malleable cast iron, GJM	< 500			
		K3.2	Cast iron with vermicular graphite, GJV; malleable cast iron, GJM	> 500			
N	N1	N1.1	Aluminium, unalloyed and alloyed < 3% Si		150-600		
		N1.2	Aluminium, alloyed ≤ 7% Si		100-500		
		N1.3	Aluminium, alloyed > 7 - 12% Si		100-400		
		N1.4	Aluminium, alloyed > 12% Si				
	N2	N2.1	Copper, unalloyed and low alloyed	< 300	100-350		
		N2.2	Copper, alloyed	> 300	100-300		
		N2.3	Brass, bronze, gunmetal	< 1,200	100-250		
	N3	N3.1	Graphite, > 8 μm	< 1,200			
		N3.2	Graphite, ≤ 8 μm				
	N4	N4.1	Plastic, thermoplastics				
N4.2		Plastic, duroplastics					
N4.3		Plastic, foam materials					
X	K1.1, K1.2	Mixed machining of cast iron (GJL and GJS)					
	K1.1, sintered	Mixed machining of cast iron and sintered steel					
	N1.2, K1.1	Mixed machining of aluminium and cast iron (GJL)					
	N1.2, K1.2	Mixed machining of aluminium and cast iron (GJS)					
	N1.2, sintered	Mixed machining of aluminium and sintered steel					

\* MAPAL machining groups

\*\* If the alloy parts Cr, Mo, Ni, V, W are in total > 8%, select the next highest MAPAL machining group.

	Carbide							PCD			
	PVD-coated				PVD-coated, mixed machining			uncoated			
	HP895	HP930	HP945	HP950	HP531			HU616/HU816	PU617	PU660	PU670
	$v_c$ [m/min]	$v_c$ [m/min]	$v_c$ [m/min]	$v_c$ [m/min]	$v_c$ [m/min]			$v_c$ [m/min]	$v_c$ [m/min]	$v_c$ [m/min]	$v_c$ [m/min]
	100-220		100-180	100-160							
	100-220		100-180	100-160							
	100-220		100-180	100-160							
	100-200		80-150	80-150							
	80-200		100-180	100-160							
	80-200		80-130	90-130							
	80-200		80-130	90-130							
			80-130	90-130							
	80-200		80-130	90-130							
	150-220										
	120-200										
	100-180		70-120	70-120							
	100-180										
		140-220	120-200								
		120-200	120-180								
		120-180	120-180								
		80-140	80-120								
		60-130	60-100								
		60-120	60-100								
							150-500	450-2.200	450-2.200	410-1.980	
							100-450	400-1.700	400-1.700	360-1.530	
							100-400	350-1.300	350-1.300	320-1.170	
								200-800	200-800	180-720	
							100-250	250-600	250-600	230-540	
							100-220	200-600	200-600	180-540	
							80-220	200-500	200-500	180-450	
							120-480	300-600	300-600	270-540	
							250-500	400-1.000	400-1.000	360-900	
							250-500	400-1.000	400-1.000	360-900	
							120-200				
							100-200				
							120-300				
							120-280				
							100-200				

The specified machining values are guide values.  
 The optimum data for the respective machining task should be determined during the test or machining.

# Cutting data recommendations for shoulder milling cutters

Feed and cutting speed

## OptiMill-Alu-Wave | SCM109 | Machine performance 25 kW to ≤40 kW

MMG*	Workpiece material	Strength/hardness [N/mm <sup>2</sup> ] [HRC]	Cooling		
			MQL/Air	Dry	Wet
N N1	N1.1 Aluminium, unalloyed and alloyed < 3% Si				✓
	N1.2 Aluminium, alloyed ≤ 7% Si				✓
	N1.3 Aluminium, alloyed > 7 - 12% Si				✓
	N1.4 Aluminium, alloyed > 12% Si				✓

## OptiMill-Alu-Wave | SCM109 | Machine performance 40 kW to ≤80 kW

MMG*	Workpiece material	Strength/hardness [N/mm <sup>2</sup> ] [HRC]	Cooling		
			MQL/Air	Dry	Wet
N N1	N1.1 Aluminium, unalloyed and alloyed < 3% Si				✓
	N1.2 Aluminium, alloyed ≤ 7% Si				✓
	N1.3 Aluminium, alloyed > 7 - 12% Si				✓
	N1.4 Aluminium, alloyed > 12% Si				✓

## OptiMill-Alu-Wave | SCM109 | Machine performance >80 kW

MMG*	Workpiece material	Strength/hardness [N/mm <sup>2</sup> ] [HRC]	Cooling		
			MQL/Air	Dry	Wet
N N1	N1.1 Aluminium, unalloyed and alloyed < 3% Si				✓
	N1.2 Aluminium, alloyed ≤ 7% Si				✓
	N1.3 Aluminium, alloyed > 7 - 12% Si				✓
	N1.4 Aluminium, alloyed > 12% Si				✓

\* MAPAL machining groups

**Full cutting**

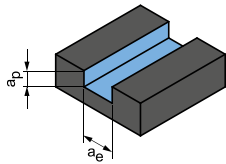

**Long projection length**  
 $a_p = 1xD \mid a_e = 1xD$   
**Over-long projection length**  
 $a_p = 1xD \mid a_e = 1xD$   
**Extra-long projection length**  
 $a_p = 0.5xD \mid a_e = 1xD$

**Part-contact cutting**

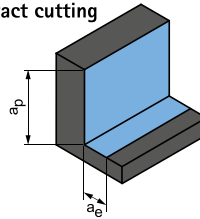

**Long projection length**  
 $a_p = 1.5xD \mid a_e = 0.6xD$   
**Over-long projection length**  
 $a_p = 1.5xD \mid a_e = 0.4xD$   
**Extra-long projection length**  
 $a_p = 1.5xD \mid a_e = 0.25xD$

Feed per tooth $f_z$ [mm/z] at diameter of milling cutter					Feed per tooth $f_z$ [mm/z] at diameter of milling cutter				
$\emptyset$	12.00	16.00	20.00	25.00	$\emptyset$	12.00	16.00	20.00	25.00
$v_c$	600 - 900	600 - 900	300 - 600	300 - 600	$v_c$	600 - 900	600 - 900	400 - 700	300 - 600
Factor $v_c$					Factor $v_c$				
<b>1</b>	0.1 - 0.18	0.12 - 0.2	0.15 - 0.2	0.15 - 0.2	<b>1</b>	0.12 - 0.22	0.15 - 0.22	0.15 - 0.22	0.15 - 0.22
<b>0.95</b>	0.1 - 0.18	0.12 - 0.2	0.15 - 0.2	0.15 - 0.2	<b>0.95</b>	0.12 - 0.22	0.15 - 0.22	0.15 - 0.22	0.15 - 0.22
<b>0.85</b>	0.1 - 0.18	0.12 - 0.2	0.15 - 0.2	0.15 - 0.2	<b>0.85</b>	0.12 - 0.22	0.15 - 0.22	0.15 - 0.22	0.15 - 0.22
<b>0.75</b>	0.1 - 0.18	0.12 - 0.2	0.15 - 0.2	0.15 - 0.2	<b>0.75</b>	0.12 - 0.22	0.15 - 0.22	0.15 - 0.22	0.15 - 0.22

Feed per tooth $f_z$ [mm/z] at diameter of milling cutter					Feed per tooth $f_z$ [mm/z] at diameter of milling cutter				
$\emptyset$	12.00	16.00	20.00	25.00	$\emptyset$	12.00	16.00	20.00	25.00
$v_c$	900 - 1,200	1,100 - 1,400	1,100 - 1,400	900 - 1,200	$v_c$	900 - 1,200	1,100 - 1,400	1,100 - 1,400	900 - 1,200
Factor $v_c$					Factor $v_c$				
<b>1</b>	0.1 - 0.18	0.12 - 0.2	0.14 - 0.21	0.15 - 0.22	<b>1</b>	0.1 - 0.22	0.15 - 0.25	0.15 - 0.25	0.15 - 0.25
<b>0.95</b>	0.1 - 0.18	0.12 - 0.2	0.14 - 0.21	0.15 - 0.22	<b>0.95</b>	0.1 - 0.22	0.15 - 0.25	0.15 - 0.25	0.15 - 0.25
<b>0.85</b>	0.1 - 0.18	0.12 - 0.2	0.14 - 0.21	0.15 - 0.22	<b>0.85</b>	0.1 - 0.22	0.15 - 0.25	0.15 - 0.25	0.15 - 0.25
<b>0.75</b>	0.1 - 0.18	0.12 - 0.2	0.14 - 0.21	0.15 - 0.22	<b>0.75</b>	0.1 - 0.22	0.15 - 0.25	0.15 - 0.25	0.15 - 0.25

Feed per tooth $f_z$ [mm/z] at diameter of milling cutter					Feed per tooth $f_z$ [mm/z] at diameter of milling cutter				
$\emptyset$	12.00	16.00	20.00	25.00	$\emptyset$	12.00	16.00	20.00	25.00
$v_c$	900 - 1,200	1,100 - 1,400	1,300 - 1,600	1,700 - 2,500	$v_c$	900 - 1,200	1,100 - 1,400	1,300 - 1,600	1,700 - 2,500
Factor $v_c$					Factor $v_c$				
<b>1</b>	0.1 - 0.18	0.12 - 0.2	0.15 - 0.23	0.15 - 0.23	<b>1</b>	0.1 - 0.22	0.13 - 0.25	0.15 - 0.27	0.15 - 0.27
<b>0.95</b>	0.1 - 0.18	0.12 - 0.2	0.15 - 0.23	0.15 - 0.23	<b>0.95</b>	0.1 - 0.22	0.13 - 0.25	0.15 - 0.27	0.15 - 0.27
<b>0.85</b>	0.1 - 0.18	0.12 - 0.2	0.15 - 0.23	0.15 - 0.23	<b>0.85</b>	0.1 - 0.22	0.13 - 0.25	0.15 - 0.27	0.15 - 0.27
<b>0.75</b>	0.1 - 0.18	0.12 - 0.2	0.15 - 0.23	0.15 - 0.23	<b>0.75</b>	0.1 - 0.22	0.13 - 0.25	0.15 - 0.27	0.15 - 0.27

The specified machining values are guide values.  
 The optimum data for the respective machining task should be determined during the test or machining.

# Cutting data recommendations for shoulder milling cutters

Feed and cutting speed

OptiMill-Diamond type 51 | SHM511, 611, 711  
 OptiMill-Diamond type 50 | SHM500  
 OptiMill-Diamond type 53 | SHM531  
 OptiMill-Diamond type 57 | SHM571

Groove milling

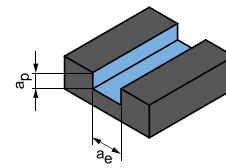

$$a_p = 0.5 \times D$$

$$a_e = 1 \times D$$

MMG*	Workpiece material	Strength/ Hardness [N/mm <sup>2</sup> ] [HRC]	Cooling			Diameter of milling cutter [mm]								
			MQL/Air	Dry	KSS	3.00 - 6.00		8.00 - 10.00		12.00 - 16.00		18.00 - 25.00		
						v <sub>c</sub> [m/min]	f <sub>z</sub> [mm]	v <sub>c</sub> [m/min]	f <sub>z</sub> [mm]	v <sub>c</sub> [m/min]	f <sub>z</sub> [mm]	v <sub>c</sub> [m/min]	f <sub>z</sub> [mm]	
N	N1	N1.1 Aluminium, unalloyed and alloyed < 3% Si	✓	✓	✓	200	0,10-0,12	500	0,12-0,15	800	0,15-0,20	1,000	0,18-0,23	
		N1.2 Aluminium, alloyed < 7% Si	✓	✓	✓	200	0,10-0,12	500	0,12-0,15	800	0,15-0,20	1,000	0,18-0,23	
		N1.3 Aluminium, alloyed > 7 - 12% Si	✓	✓	✓	200	0,10-0,12	500	0,12-0,15	800	0,15-0,20	1,000	0,18-0,23	
		N1.4 Aluminium, alloyed > 12% Si	✓	✓	✓	200	0,10-0,12	500	0,12-0,15	800	0,15-0,20	1,000	0,18-0,23	
	N2	N2.1 Copper, unalloyed and low alloyed	< 300	✓	✓	✓	200	0,10-0,12	500	0,12-0,15	800	0,15-0,20	1,000	0,18-0,23
		N2.2 Copper, alloyed	> 300	✓	✓	✓	200	0,10-0,12	500	0,12-0,15	800	0,15-0,20	1,000	0,18-0,23
		N2.3 Brass, bronze, gunmetal	< 1,200	✓	✓	✓	200	0,10-0,12	500	0,12-0,15	800	0,15-0,20	1,000	0,18-0,23
	N4	N4.1 Plastic, thermoplastics												
		N4.2 Plastic, duroplastics		✓	✓	✓	200	0,10-0,12	500	0,12-0,15	800	0,15-0,20	1,000	0,18-0,23
		N4.3 Plastic, foam materials												
C	C1.1 Plastic range, reinforced with aramid fibre (AFK)													
	C1.2 Plastic range (duroplastic), CFK/GFK		✓	✓	✓	200	0,10-0,12	500	0,12-0,15	800	0,15-0,20	1,000	0,18-0,23	
	C1.3 Plastic range (thermoplastic), CFK/GFK		✓	✓	✓	200	0,10-0,12	500	0,12-0,15	800	0,15-0,20	1,000	0,18-0,23	
	C2.1 Carbon range, reinforced with carbon fibre (CFC)		✓	✓	✓	200	0,10-0,12	500	0,12-0,15	800	0,15-0,20	1,000	0,18-0,23	

\* MAPAL machining groups

**Roughing**

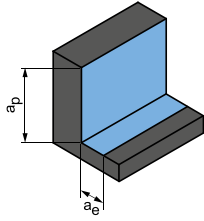

$$a_p = 0.5 \times D$$

$$a_e = 0.25 \times D$$

**Finishing**

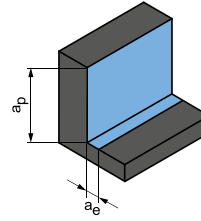

$$a_p = 0.5 \times D$$

$$a_e = 0.1 \times D$$

		Diameter of milling cutter [mm]								Diameter of milling cutter [mm]							
		3.00 - 6.00		8.00 - 10.00		12.00 - 16.00		18.00 - 25.00		3.00 - 6.00		8.00 - 10.00		12.00 - 16.00		18.00 - 25.00	
	$v_c$ [m/min]	$f_z$ [mm]	$v_c$ [m/min]	$f_z$ [mm]	$v_c$ [m/min]	$f_z$ [mm]	$v_c$ [m/min]	$f_z$ [mm]	$v_c$ [m/min]	$f_z$ [mm]	$v_c$ [m/min]	$f_z$ [mm]	$v_c$ [m/min]	$f_z$ [mm]	$v_c$ [m/min]	$f_z$ [mm]	
	<b>240</b>	0,10-0,12	<b>480</b>	0,12-0,16	<b>720</b>	0,16-0,20	<b>960</b>	0,16-0,22	<b>300</b>	0,12-0,15	<b>600</b>	0,15-0,20	<b>900</b>	0,20-0,25	<b>1,200</b>	0,20-0,27	
	<b>240</b>	0,10-0,12	<b>480</b>	0,12-0,16	<b>720</b>	0,16-0,20	<b>960</b>	0,16-0,22	<b>300</b>	0,12-0,15	<b>600</b>	0,15-0,20	<b>900</b>	0,20-0,25	<b>1,200</b>	0,20-0,27	
	<b>240</b>	0,10-0,12	<b>480</b>	0,12-0,16	<b>720</b>	0,16-0,20	<b>960</b>	0,16-0,22	<b>300</b>	0,12-0,15	<b>600</b>	0,15-0,20	<b>900</b>	0,20-0,25	<b>1,200</b>	0,20-0,27	
	<b>240</b>	0,10-0,12	<b>480</b>	0,12-0,16	<b>720</b>	0,16-0,20	<b>960</b>	0,16-0,22	<b>300</b>	0,12-0,15	<b>600</b>	0,15-0,20	<b>900</b>	0,20-0,25	<b>1,200</b>	0,20-0,27	
	<b>240</b>	0,10-0,12	<b>480</b>	0,12-0,16	<b>720</b>	0,16-0,20	<b>960</b>	0,16-0,22	<b>300</b>	0,12-0,15	<b>600</b>	0,15-0,20	<b>900</b>	0,20-0,25	<b>1,200</b>	0,20-0,27	
	<b>240</b>	0,10-0,12	<b>480</b>	0,12-0,16	<b>720</b>	0,16-0,20	<b>960</b>	0,16-0,22	<b>300</b>	0,12-0,15	<b>600</b>	0,15-0,20	<b>900</b>	0,20-0,25	<b>1,200</b>	0,20-0,27	
	<b>240</b>	0,10-0,12	<b>480</b>	0,12-0,16	<b>720</b>	0,16-0,20	<b>960</b>	0,16-0,22	<b>300</b>	0,12-0,15	<b>600</b>	0,15-0,20	<b>900</b>	0,20-0,25	<b>1,200</b>	0,20-0,27	
	<b>240</b>	0,10-0,12	<b>480</b>	0,12-0,16	<b>720</b>	0,16-0,20	<b>960</b>	0,16-0,22	<b>300</b>	0,12-0,15	<b>600</b>	0,15-0,20	<b>900</b>	0,20-0,25	<b>1,200</b>	0,20-0,27	
	<b>240</b>	0,10-0,12	<b>480</b>	0,12-0,16	<b>720</b>	0,16-0,20	<b>960</b>	0,16-0,22	<b>300</b>	0,12-0,15	<b>600</b>	0,15-0,20	<b>900</b>	0,20-0,25	<b>1,200</b>	0,20-0,27	
	<b>240</b>	0,10-0,12	<b>480</b>	0,12-0,16	<b>720</b>	0,16-0,20	<b>960</b>	0,16-0,22	<b>300</b>	0,12-0,15	<b>600</b>	0,15-0,20	<b>900</b>	0,20-0,25	<b>1,200</b>	0,20-0,27	

The specified machining values are guide values.  
The optimum data for the respective machining task should be determined during the test or machining.

# Cutting data recommendations for ball nose milling cutters

Feed and cutting speed

## OptiMill-Diamond-Radius | SHM521

MMG*	Workpiece material	Strength/hardness [N/mm <sup>2</sup> ] [HRC]	Cooling			
			MQL/Air	Dry	KSS	
N	N1	N1.1 Aluminium, unalloyed and alloyed < 3% Si	✓	✓	✓	
		N1.2 Aluminium, alloyed ≤ 7% Si	✓	✓	✓	
		N1.3 Aluminium, alloyed > 7 - 12% Si	✓	✓	✓	
		N1.4 Aluminium, alloyed > 12% Si	✓	✓	✓	
	N2	N2.1 Copper, unalloyed and low alloyed	< 300	✓	✓	✓
		N2.2 Copper, alloyed	> 300	✓	✓	✓
		N2.3 Brass, bronze, gunmetal	< 1,200	✓	✓	✓
	N4	N4.1 Plastic, thermoplastics				
		N4.2 Plastic, duroplastics		✓	✓	✓
		N4.3 Plastic, foam materials				
C	C1	C1.1 Plastic range, reinforced with aramid fibre (AFK)	✓	✓	✓	
		C1.2 Plastic range (duroplastic), CFK/GFK	✓	✓	✓	
		C1.3 Plastic range (thermoplastic), CFK/GFK	✓	✓	✓	
		C2.1 Carbon range, reinforced with carbon fibre (CFC)	✓	✓	✓	

## Correction factors

Length	$f_z$ & $v_c$
A/B	1,0
C	0,9
D	0,7
E	0,6



**Finishing**

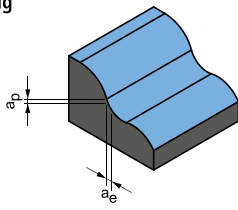

$a_p = 0.1 \times D$   
 $a_e = 0.1 \times D$

Diameter of milling cutter [mm]					
3.00 - 6.00		8.00 - 10.00		12.00 - 16.00	
$v_c$ [m/min]	$f_z$ [mm]	$v_c$ [m/min]	$f_z$ [mm]	$v_c$ [m/min]	$f_z$ [mm]
<b>300</b>	0.12 - 0.15	<b>600</b>	0.15 - 0.20	<b>900</b>	0.20 - 0.25
<b>300</b>	0.12 - 0.15	<b>600</b>	0.15 - 0.20	<b>900</b>	0.20 - 0.25
<b>300</b>	0.12 - 0.15	<b>600</b>	0.15 - 0.20	<b>900</b>	0.20 - 0.25
<b>300</b>	0.12 - 0.15	<b>600</b>	0.15 - 0.20	<b>900</b>	0.20 - 0.25
<b>300</b>	0.12 - 0.15	<b>600</b>	0.15 - 0.20	<b>900</b>	0.20 - 0.25
<b>300</b>	0.12 - 0.15	<b>600</b>	0.15 - 0.20	<b>900</b>	0.20 - 0.25
<b>300</b>	0.12 - 0.15	<b>600</b>	0.15 - 0.20	<b>900</b>	0.20 - 0.25
<b>300</b>	0.12 - 0.15	<b>600</b>	0.15 - 0.20	<b>900</b>	0.20 - 0.25
<b>300</b>	0.12 - 0.15	<b>600</b>	0.15 - 0.20	<b>900</b>	0.20 - 0.25
<b>300</b>	0.12 - 0.15	<b>600</b>	0.15 - 0.20	<b>900</b>	0.20 - 0.25
<b>300</b>	0.12 - 0.15	<b>600</b>	0.15 - 0.20	<b>900</b>	0.20 - 0.25

The specified machining values are guide values.  
 The optimum data for the respective machining task should be determined during the test or machining.

# Cutting data recommendations for corner radius milling cutters

Feed and cutting speed

Groove milling

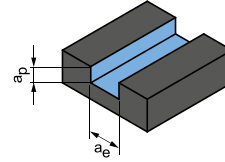

$$a_p = 0.5 \times D$$

$$a_e = 1 \times D$$

OptiMill-Diamond-Torus | SHM551

MMG*	Workpiece material	Strength/ Hardness [N/mm <sup>2</sup> ] [HRC]	Cooling			Diameter of milling cutter [mm]						
			MQL/Air	Dry	KSS	3.00 - 6.00		8.00 - 10.00		12.00		
						v <sub>c</sub> [m/min]	f <sub>z</sub> [mm]	v <sub>c</sub> [m/min]	f <sub>z</sub> [mm]	v <sub>c</sub> [m/min]	f <sub>z</sub> [mm]	
N	N1	N1.1 Aluminium, unalloyed and alloyed < 3% Si	✓	✓	✓	200	0,10-0,12	500	0,12-0,18	800	0,15-0,20	
		N1.2 Aluminium, alloyed < 7% Si	✓	✓	✓	200	0,10-0,12	500	0,12-0,18	800	0,15-0,20	
		N1.3 Aluminium, alloyed > 7 - 12% Si	✓	✓	✓	200	0,10-0,12	500	0,12-0,18	800	0,15-0,20	
		N1.4 Aluminium, alloyed > 12% Si	✓	✓	✓	200	0,10-0,12	500	0,12-0,18	800	0,15-0,20	
	N2	N2.1 Copper, unalloyed and low alloyed	< 300	✓	✓	✓	200	0,10-0,12	500	0,12-0,18	800	0,15-0,20
		N2.2 Copper, alloyed	> 300	✓	✓	✓	200	0,10-0,12	500	0,12-0,18	800	0,15-0,20
		N2.3 Brass, bronze, gunmetal	< 1,200	✓	✓	✓	200	0,10-0,12	500	0,12-0,18	800	0,15-0,20
	N4	N4.1 Plastic, thermoplastics										
		N4.2 Plastic, duroplastics		✓	✓	✓	200	0,10-0,12	500	0,12-0,18	800	0,15-0,20
		N4.3 Plastic, foam materials										
C	C1.1 Plastic range, reinforced with aramid fibre (AFK)											
	C1.2 Plastic range (duroplastic), CFK/GFK		✓	✓	✓	200	0,10-0,12	500	0,12-0,18	800	0,15-0,20	
	C1.3 Plastic range (thermoplastic), CFK/GFK		✓	✓	✓	200	0,10-0,12	500	0,12-0,18	800	0,15-0,20	
	C2.1 Carbon range, reinforced with carbon fibre (CFC)		✓	✓	✓	200	0,10-0,12	500	0,12-0,18	800	0,15-0,20	

\* MAPAL machining groups

**Roughing**

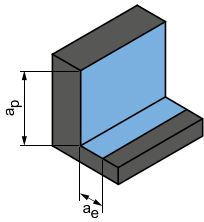

$$a_p = 0.5 \times D$$

$$a_e = 0.25 \times D$$

**Finishing**

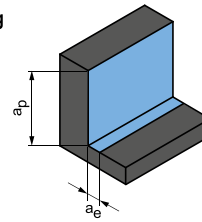

$$a_p = 0.5 \times D$$

$$a_e = 0.1 \times D$$

		Diameter of milling cutter [mm]						Diameter of milling cutter [mm]					
		3.00 - 6.00		8.00 - 10.00		12.00		3.00 - 6.00		8.00 - 10.00		12.00	
	$v_c$ [m/min]	$f_z$ [mm]	$v_c$ [m/min]	$f_z$ [mm]	$v_c$ [m/min]	$f_z$ [mm]	$v_c$ [m/min]	$f_z$ [mm]	$v_c$ [m/min]	$f_z$ [mm]	$v_c$ [m/min]	$f_z$ [mm]	
	<b>240</b>	0,10-0,12	<b>480</b>	0,12-0,16	<b>720</b>	0,16-0,18	<b>300</b>	0,12-0,15	<b>600</b>	0,15-0,20	<b>900</b>	0,20-0,23	
	<b>240</b>	0,10-0,12	<b>480</b>	0,12-0,16	<b>720</b>	0,16-0,18	<b>300</b>	0,12-0,15	<b>600</b>	0,15-0,20	<b>900</b>	0,20-0,23	
	<b>240</b>	0,10-0,12	<b>480</b>	0,12-0,16	<b>720</b>	0,16-0,18	<b>300</b>	0,12-0,15	<b>600</b>	0,15-0,20	<b>900</b>	0,20-0,23	
	<b>240</b>	0,10-0,12	<b>480</b>	0,12-0,16	<b>720</b>	0,16-0,18	<b>300</b>	0,12-0,15	<b>600</b>	0,15-0,20	<b>900</b>	0,20-0,23	
	<b>240</b>	0,10-0,12	<b>480</b>	0,12-0,16	<b>720</b>	0,16-0,18	<b>300</b>	0,12-0,15	<b>600</b>	0,15-0,20	<b>900</b>	0,20-0,23	
	<b>240</b>	0,10-0,12	<b>480</b>	0,12-0,16	<b>720</b>	0,16-0,18	<b>300</b>	0,12-0,15	<b>600</b>	0,15-0,20	<b>900</b>	0,20-0,23	
	<b>240</b>	0,10-0,12	<b>480</b>	0,12-0,16	<b>720</b>	0,16-0,18	<b>300</b>	0,12-0,15	<b>600</b>	0,15-0,20	<b>900</b>	0,20-0,23	
	<b>240</b>	0,10-0,12	<b>480</b>	0,12-0,16	<b>720</b>	0,16-0,18	<b>300</b>	0,12-0,15	<b>600</b>	0,15-0,20	<b>900</b>	0,20-0,23	
	<b>240</b>	0,10-0,12	<b>480</b>	0,12-0,16	<b>720</b>	0,16-0,18	<b>300</b>	0,12-0,15	<b>600</b>	0,15-0,20	<b>900</b>	0,20-0,23	
	<b>240</b>	0,10-0,12	<b>480</b>	0,12-0,16	<b>720</b>	0,16-0,18	<b>300</b>	0,12-0,15	<b>600</b>	0,15-0,20	<b>900</b>	0,20-0,23	

The specified machining values are guide values.  
The optimum data for the respective machining task should be determined during the test or machining.

# Cutting data recommendations for trochoidal milling cutters

Feed and cutting speed

## OptiMill-Tro-Inox | SCM292

MMG*	Workpiece material	Strength/hardness [N/mm <sup>2</sup> ] [HRC]	Cooling		
			MQL/Air	Dry	KSS
M	M1.1	Stainless steels, austenitic	< 700	✓	✓
	M1.2	Stainless steels, ferritic/austenitic (duplex)	< 1,000		✓
	M2.1	Stainless cast steel, austenitic	< 700	✓	✓
	M3.1	Stainless cast steel, ferritic/austenitic (duplex)	< 1,000		✓
S	S1.1	Titanium, titanium alloys	< 400		✓
	S2.1	Titanium, titanium alloys	< 1,200		✓
	S2.2	Titanium, titanium alloys	> 1,200		✓

### Correction factors

Factor	v <sub>c</sub>	a <sub>e</sub>	h <sub>m</sub>
	M		
2xD	1,05	1,05	1,05
3xD	1,00	1,00	1,00
4xD	0,92	0,90	0,94
5xD	0,80	0,80	0,87

### Groove milling

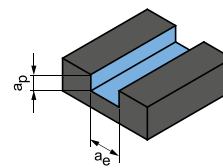

$$a_p = 1xD$$

$$a_e = 1xD$$

## OptiMill-Titan-HPC | SCM394

MMG*	Workpiece material	Strength/Hardness [N/mm <sup>2</sup> ] [HRC]	Cooling			v <sub>c</sub> [m/min]	f <sub>z</sub> [mm/z]						
			MQL/Air	Dry	KSS		Diameter of milling cutter [mm]						
							6.00	8.00	10.00	12.00	16.00	20.00	25.00
S	S1.1	Titanium, titanium alloys	< 400		✓	85	0.035	0.045	0.054	0.062	0.075	0.086	0.096
	S2.1	Titanium, titanium alloys	< 1,200		✓	80	0.029	0.037	0.044	0.050	0.061	0.070	0.078
	S2.2	Titanium, titanium alloys	> 1,200		✓	50	0.025	0.033	0.039	0.045	0.055	0.062	0.070

**Note:**

In the case of trochoidal milling, the specified cutting conditions change during the machining process. This also depends on the CAM software used and the machining position of the tool in the workpiece. The feed and cutting width or contact angle are constantly changing during machining in order to achieve, as far as is possible, the most constant average chip thickness depending on the contour.

\* MAPAL machining groups

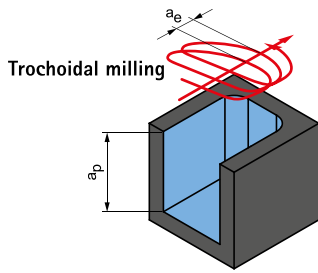

Trochoidal milling

$a_p$  = depending on the tool length  
 $a_e$  = depending on the workpiece material

$v_c$ [m/min]	$f_z$ [mm/z] in % of D	$a_e$ [mm] in % of D	$h_m$ max. [mm] in % of D	Machining example	
160 - 220	0.8 - 1.1	5 - 10	0.48 - 0.60	<b>X5CrNi18-8</b> $\phi = 12$ mm $v_c = 180$ m/min $f_z = 0.09$ mm	$a_e = 1.2$ mm $a_p = 32$ mm
120 - 160	0.6 - 1.0	5 - 10	0.46 - 0.58		
160 - 220	0.8 - 1.1	5 - 10	0.48 - 0.60		
120 - 160	0.6 - 1.0	5 - 10	0.46 - 0.58		
110 - 170	0.65 - 1.3	6 - 12	0.52 - 0.60	<b>TiAl6V4</b> $\phi = 12$ mm $v_c = 140$ m/min $f_z = 0.09$ mm	$a_e = 1.2$ mm $a_p = 30$ mm
90 - 150	0.6 - 1.2	5 - 10	0.46 - 0.56		
70 - 130	0.4 - 1.0	5 - 10	0.42 - 0.54		

Roughing

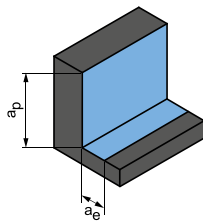

$a_p = 1,5xD$   
 $a_e = 0,25xD$

Finishing

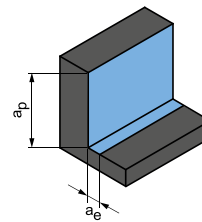

$a_p = 1,5xD$   
 $a_e = 0,1xD$

$v_c$ [m/min]	$f_z$ [mm/z]							$v_c$ [m/min]	$f_z$ [mm/z]						
	Diameter of milling cutter [mm]								Diameter of milling cutter [mm]						
	6.00	8.00	10.00	12.00	16.00	20.00	25.00		6.00	8.00	10.00	12.00	16.00	20.00	25.00
135	0.059	0.076	0.091	0.104	0.127	0.146	0.163	160	0.094	0.120	0.144	0.165	0.202	0.230	0.257
120	0.049	0.062	0.074	0.085	0.104	0.119	0.133	145	0.077	0.098	0.117	0.135	0.165	0.189	0.210
80	0.043	0.055	0.066	0.076	0.093	0.106	0.118	95	0.068	0.087	0.104	0.120	0.147	0.168	0.187

The specified machining values are guide values.  
 The optimum data for the respective machining task should be determined during the test or machining.

# Cutting data recommendations for face milling cutter

Cutting speed

Face milling

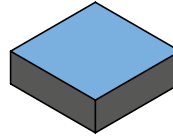

NeoMill-T-Finish

MMG*	Workpiece material	Cooling			HU616		HP616		HP626		HC695		PU617		PU620	
		MQL/Air	Dry	KSS	>0.6	<0.6	>0.6	<0.6	>0.6	<0.6	>0.6	<0.6	>0.6	<0.6	>0.6	<0.6
N N1	N1.1 Aluminium, unalloyed and alloyed < 3% Si	✓	✓	✓	500	500	700	700	700	700	1,200	1,800	5,600	6,000	5,600	6,000
	N1.2 Aluminium, alloyed < 7% Si	✓	✓	✓	300	360	400	480	400	480	1,000	1,100	4,800	5,000	4,800	5,000
	N1.3 Aluminium, alloyed > 7 - 12% Si	✓	✓	✓	230	280	300	360	300	360	800	900	3,450	3,600	3,450	3,600
	N1.4 Aluminium, alloyed > 12% Si	✓	✓	✓			220	270	220	270	500	600	1,100	1,500	1,100	1,500

\* MAPAL machining groups  
 The lower Vc value always applies in the case of different tipping between periphery and wiper.  
 Cutting data is recommended when preparing a quotation.

# Cutting data recommendation for face milling cutters with PCD

Cutting speed



## FaceMill-Diamond-ES

MMG*	Workpiece material	Strength/ Hardness [N/mm <sup>2</sup> ] [HRC]	FaceMill-Diamond-ES			
			v <sub>c</sub> [m/min]	f <sub>z</sub> [mm]		
			f <sub>z</sub> [mm]			
			Cutting depth a <sub>p</sub> max. 5 mm	Cutting depth a <sub>p</sub> max. 5–10 mm		
N	N1	N1.1 Aluminium, unalloyed and alloyed < 3% Si		max. 6,000	to 0.3	to 0.2
		N1.2 Aluminium, alloyed ≤ 7% Si		max. 6,000		
		N1.3 Aluminium, alloyed > 7 - 12% Si		max. 6,000		
		N1.4 Aluminium, alloyed > 12% Si		max. 2,000		
	N2	N2.1 Copper, unalloyed and low alloyed	< 300	max. 6,000		
		N2.2 Copper, alloyed	> 300	max. 2,000		
		N2.3 Brass, bronze, gunmetal	< 1,200	max. 2,000		
	N3	N3.1 Graphite		max. 2,000		
	N4	N4.1 Plastic, thermoplastics		max. 2,000		
		N4.2 Plastic, duroplastics		max. 2,000		

\* MAPAL machining groups

# Cutting data recommendations for shoulder milling cutters

Cutting speed

Shoulder milling

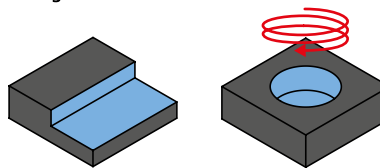

NeoMill-AluQBig

MMG*	Workpiece material	Cooling			HU612	HP675	HP665	HC660
		MQL/Air	Dry	KSS	$v_c$ [m/min]			
N N1	N1.1 Aluminium, unalloyed and alloyed < 3% Si	✓		✓	600-5.000	600-5.000	600-5.000	600-5.000
	N1.2 Aluminium, alloyed < 7% Si	✓		✓		400-2.500		500-3.000
	N1.3 Aluminium, alloyed > 7 - 12% Si	✓		✓		300-1.600		350-2.000
	N1.4 Aluminium, alloyed > 12% Si	✓	✓			200-1.200		250-1.500

\* MAPAL machining groups

The lower  $v_c$  value always applies in the case of different tipping between periphery and wiper.  
Cutting data is recommended when preparing a quotation.



Table for spindle speed selection, independent of diameter, projection ratio L/d <2.2

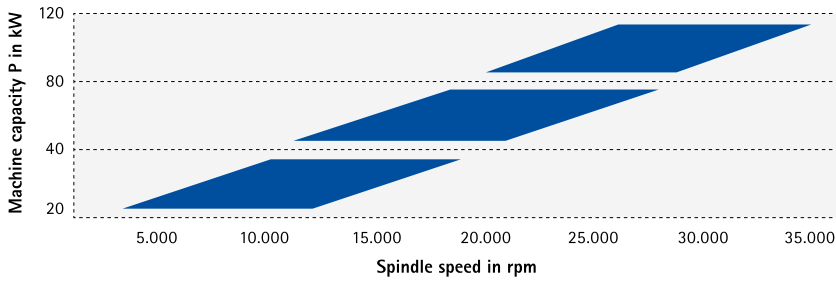

**Note:**

Maximum permissible operating speeds must not be exceeded, as otherwise the function and/or safety are no longer guaranteed. If possible, a higher  $v_c$  is to be selected,  $f_z$  ideally at 0.2–0.25 mm/tooth, taking into account the machine conditions (material, spindle, clamping setup, tool diameter, projection length, cooling media). The spindle diagram is helpful for correct selection of the spindle speed.

**Example:**

Machine 35 kW, (max. speed 20,000)

**Objective:** max. material removal rate

Diameter of milling cutter $\phi 32$ , $A_e=32$					
Case 1	Case 2	Case 3	Case 4	Case 5	
$a_p = 13$ mm (max)	$a_p = 10$ mm	$a_p = 6$ mm	$a_p = 6.5$ mm	$a_p = 6$ mm	
Speed n [rpm]	7,000	9,000	15,000	18,000	20,000
Cutting speed $v_c$ [m/min]	704	905	1,508	1,810	2,011
Feed/tooth $f_z$ [mm]	0.30 (max.)	0.30	0.30	0.21	0.20
Required power (kW)	28	28	28	28	28
Required torque (Nm)	38	30	18	15	13

Material removal rate is 2.6 litres/minute

**Result:**

Min. spindle speed for max. Q for this tool $\phi$	Machining with high $a_p$	Cutting speed for minimised built-up edge formation	Ideal machining, $f_z=0.21$	NOT recommended, spindle at max. speed
--	---------------------------	---	-----------------------------	--

**Torque and performance**

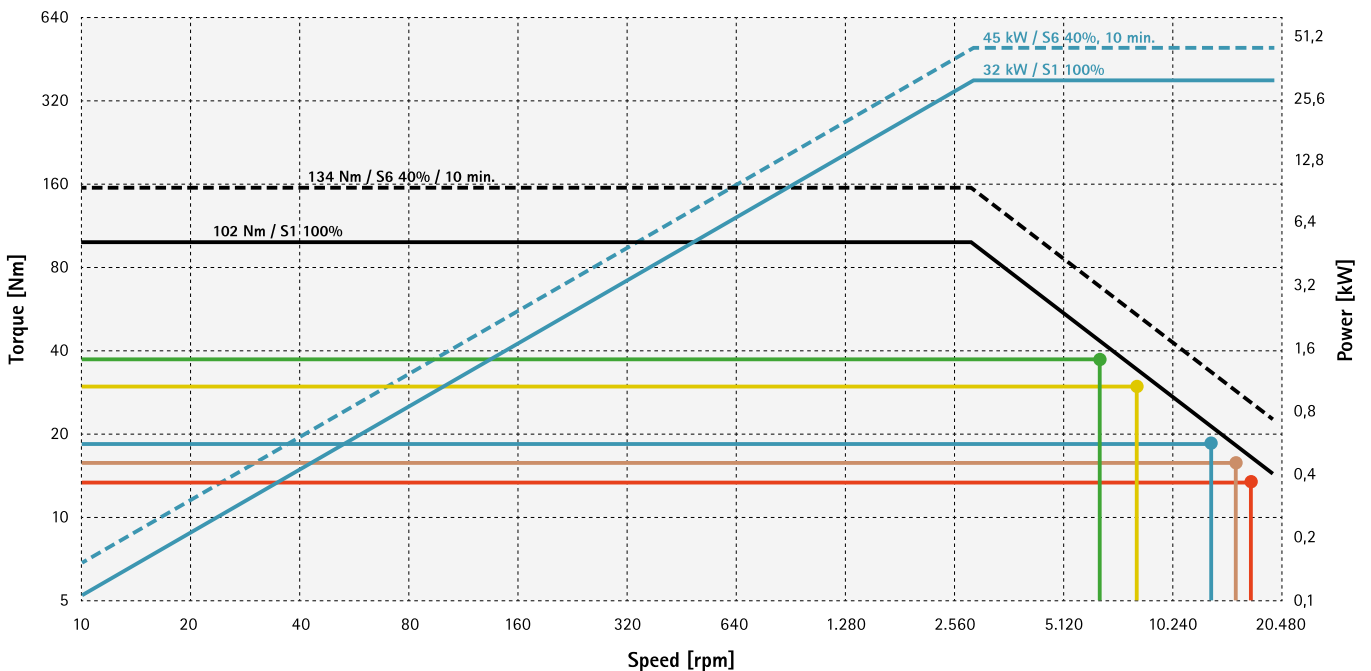

- Case 1: N = 7,000 rpm |  $f_z = 0.3$  |  $a_p = 13$  mm
- Case 2: N = 9,000 rpm |  $f_z = 0.3$  |  $a_p = 10$  mm
- Case 3: N = 15,000 rpm |  $f_z = 0.3$  |  $a_p = 6$  mm
- Case 4: N = 18,000 rpm |  $f_z = 0.21$  |  $a_p = 6.5$  mm
- Case 5: N = 20,000 rpm |  $f_z = 0.2$  |  $a_p = 6$  mm

# Helix milling pitch

For XDHT indexable inserts with corner radius

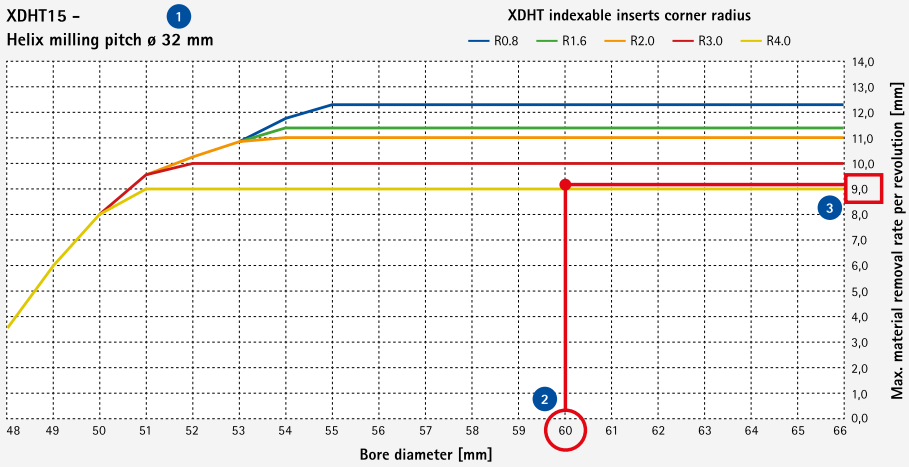
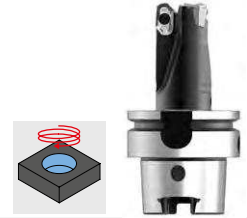

**Procedure:**

- 1 Define diameter of the milling cutter
- 2 Select diameter of the bore created
- 3 Select line with the present indexable insert radius

**Result:**  
Max. material removal rate per revolution [mm] = 9.2 mm

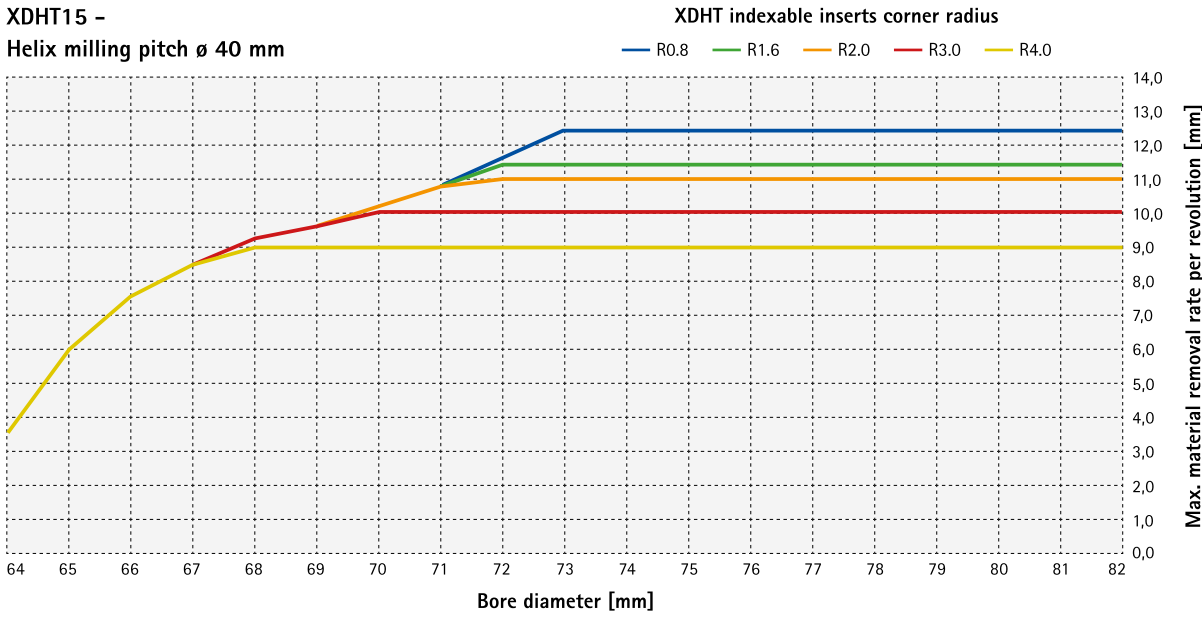
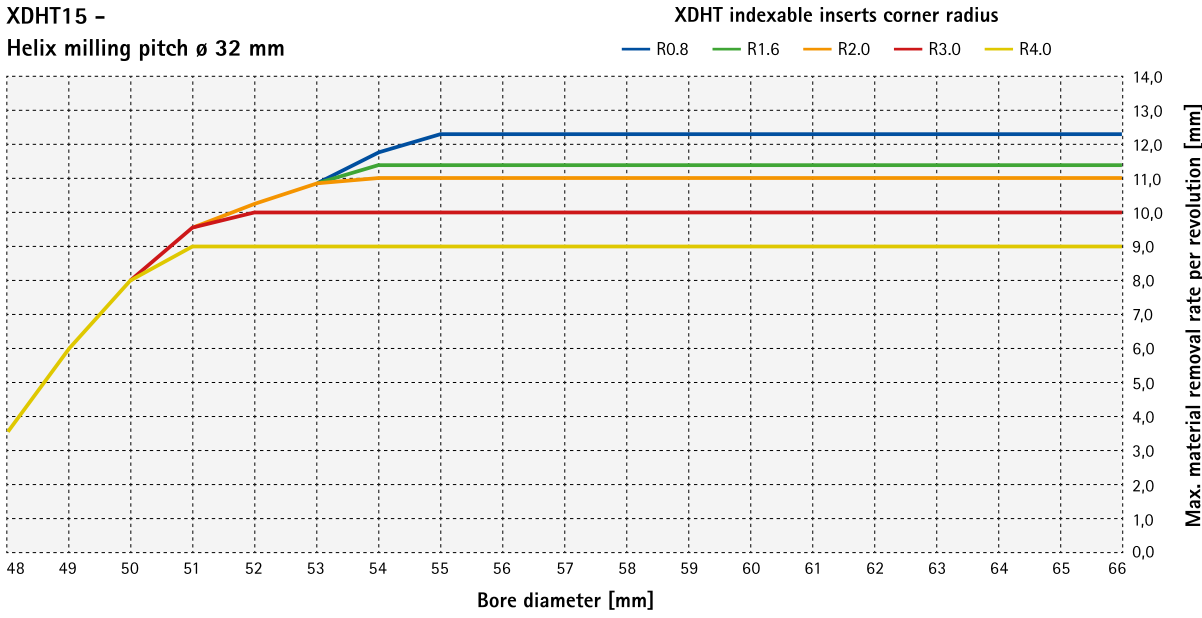

**XDHT15 -**  
Helix milling pitch  $\varnothing$  50 mm

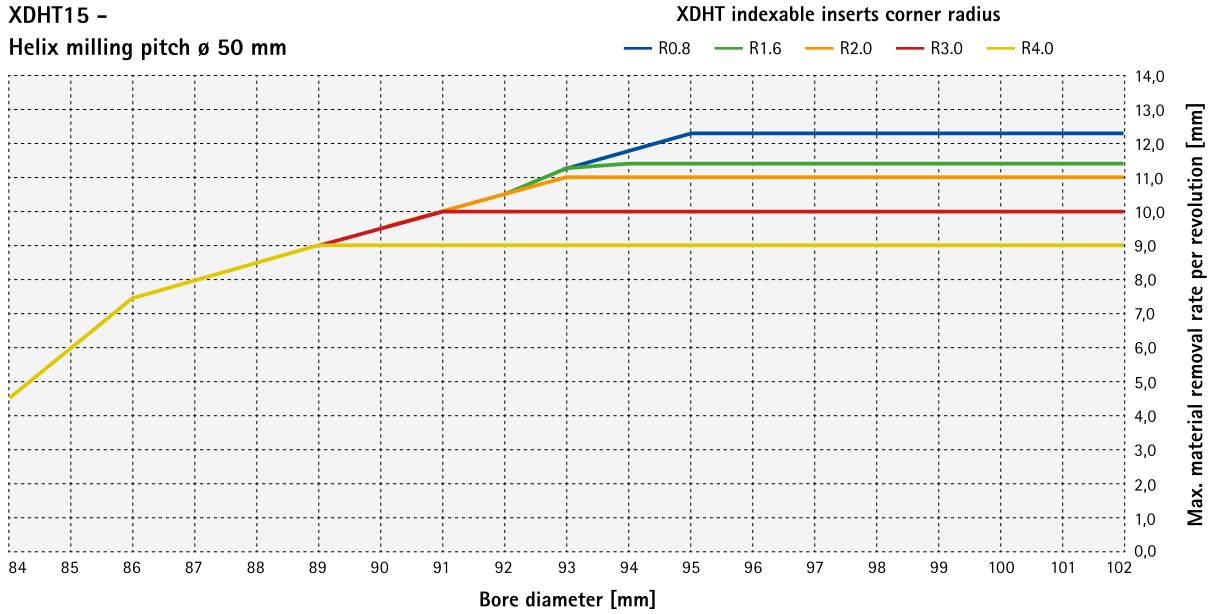

**XDHT15 -**  
Helix milling pitch  $\varnothing$  63 mm

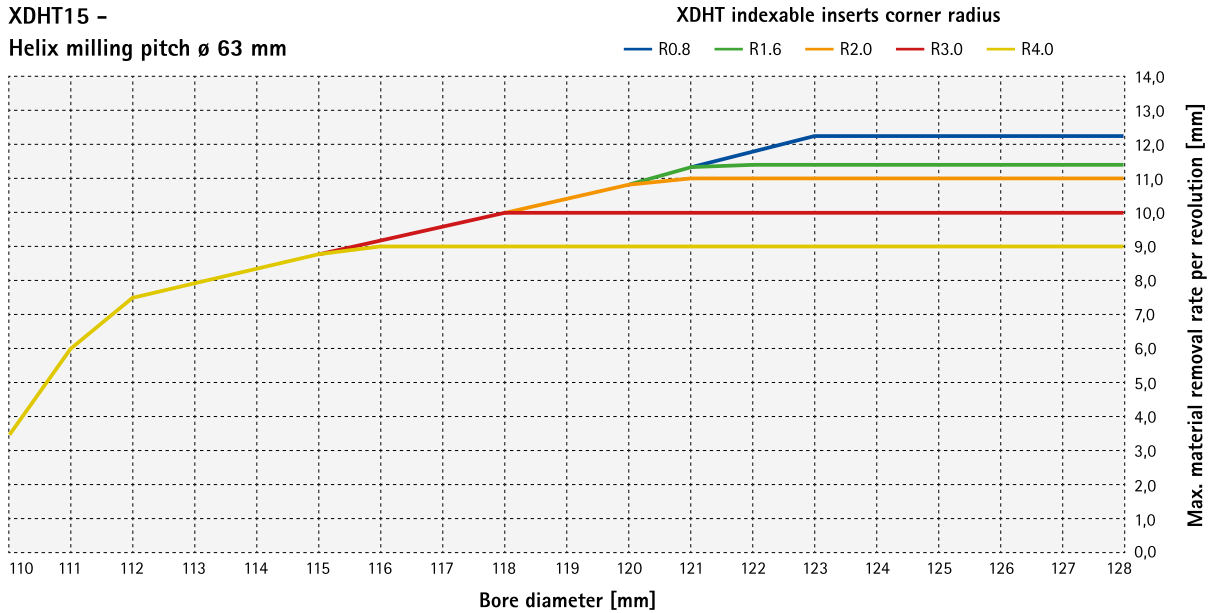

**XDHT15 -**  
Helix milling pitch  $\varnothing$  80 mm

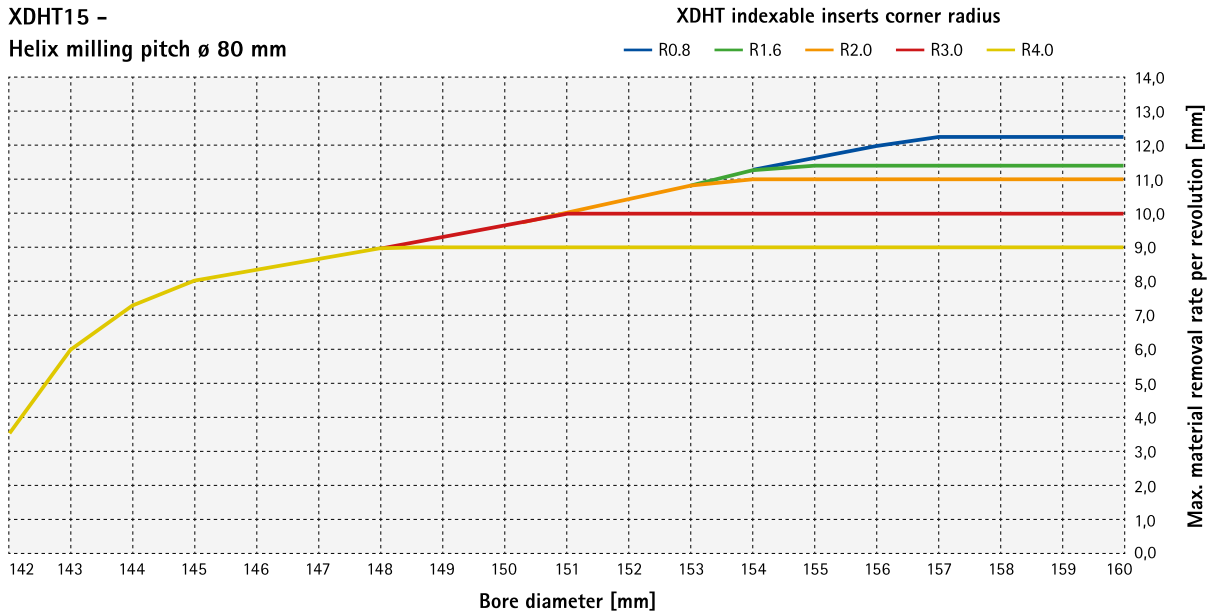

# Helix milling

NeoMill-Alu-QBig

## Selection of the milling cutter diameter as a function of the size of the bore

In the case of centre-cutting milling cutters it is important to select the correct ratio of diameter of milling cutter and bore diameter. The indexable insert must cut along the centre axis.

If the milling cutter diameter is too small, there is a core in the centre.

If the milling cutter diameter is too large, the centre is not machined. As a result a protrusion is left. This protrusion presses the milling cutter axially. This leads to a collision between the workpiece and tool.

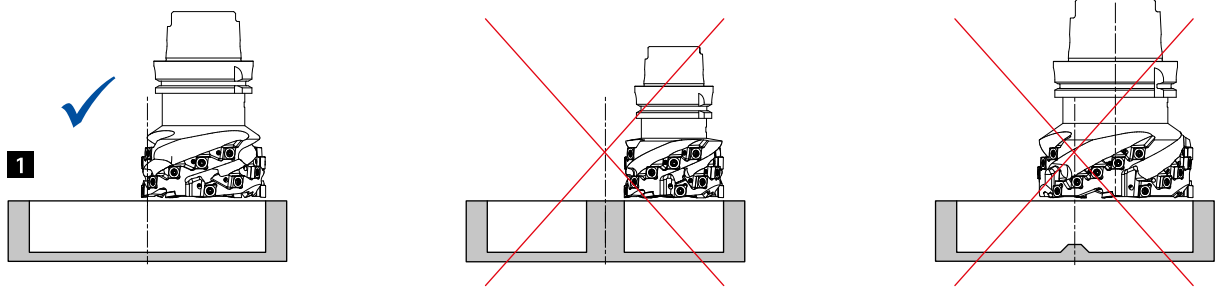

### Level bottom of the bore for blind bore machining

$a_p$  max. [mm] = 13

Cutting edge radius	$a_p$ max. without shoulder	32		40		50		63		80	
		max. Ø	min. Ø	max. Ø	min. Ø	max. Ø	min. Ø	max. Ø	min. Ø	max. Ø	min. Ø
0,8	12,2	62,4	56,4	78,4	72,4	98,4	92,4	124,4	118,4	158,4	152,4
1,6	11,4	60,8	56,4	76,8	72,4	96,8	92,4	122,8	118,4	156,8	152,4
2,0	11,0	60,0	56,4	76,0	72,4	96,0	92,4	122,0	118,4	156,0	152,4
3,0	10,0	58,0	54,4	74,0	70,4	94,0	90,4	120,0	116,4	154,0	150,4
4,0	9,0	56,0	52,4	72,0	68,4	92,0	88,4	118,0	114,4	152,0	148,4

# Cutting data recommendations for milling cutter with indexable inserts

Cutting speed

NeoMill-Titan-2-Shell  
NeoMill-Titan-2-Corner  
NeoMill-4-Hi-Feed90

MMG*		Workpiece material	Strength/ Hardness [N/mm <sup>2</sup> ] [HRC]	Carbide PVD-coated						
				HP990		HP993		HP995		
				>0.6	<0.6	>0.6	<0.6	>0.6	<0.6	
S	S1	S1.1	Titanium, titanium alloys	< 400	50	55	60	70	60	70
	S2	S2.1	Titanium, titanium alloys	< 1,200	35	45	45	55	45	55
		S2.2	Titanium, titanium alloys	> 1,200	30	35	40	50	40	50
	S3	S3.1	Nickel, unalloyed and alloyed	< 900	40	45	50	60	50	60
		S3.2	Nickel, unalloyed and alloyed	> 900	35	40	45	55	45	55
	S4	S4.1	High-temperature super alloy, Ni-, Co-, and Fe-based		30	35	40	50	40	50
	S5	S5.1	Molybdenum and tungsten alloys		60	65	70	80	70	80

\* MAPAL machining groups  
The specified machining values are guide values.

**Note:**  
A cutting depth that is bigger or smaller than the corner radius of the insert chose be chosen for shoulder milling.

# Cutting data recommendation for shell end milling cutter

Feed and cutting speed

## TGMill-4-Shell

MMG*	Workpiece material	Strength/hardness [N/mm <sup>2</sup> ] [HRC]	Cooling			
			MQL/Air	Dry	KSS	
P	P1.1	Structural, machining, case hardened and tempering steels, unalloyed	< 700		✓	
	P1.2	Structural, machining, case hardened and tempering steels, unalloyed	< 1,200		✓	
	P2.1	Nitriding, hardening and tempering steels, alloyed	< 900		✓	
	P2.2	Nitriding, hardening and tempering steels, alloyed	< 1,400		✓	
	P3.1	Tool, bearing, spring and high-speed steels**	< 800		✓	
	P3.2	Tool, bearing, spring and high-speed steels**	< 1,000		✓	
	P3.3	Tool, bearing, spring and high-speed steels**	< 1,500		✓	
	P4.1	Stainless steels, ferritic and martensitic				
	P5.1	Cast steel				
	P6.1	Stainless cast steels, ferritic and martensitic				
M	M1.1	Stainless steels, austenitic	< 700		✓	
	M1.2	Stainless steels, ferritic/austenitic (duplex)	< 1,000			
	M2.1	Stainless cast steel, austenitic	< 700			
	M3.1	Stainless cast steel, ferritic/austenitic (duplex)	< 1,000			
K	K1.1	Cast iron with lamellar graphite (grey cast iron), GJL	< 300		✓	
	K2.1	Cast iron with spheroidal graphite, GJS	< 500		✓	
	K2.2	Cast iron with spheroidal graphite, GJS	500-800			
	K2.3	Cast iron with spheroidal graphite, GJS	> 800			
	K3.1	Cast iron with vermicular graphite, GJV; malleable cast iron, GJM	< 500			
	K3.2	Cast iron with vermicular graphite, GJV; malleable cast iron, GJM	> 500			
N	N1.1	Aluminium, unalloyed and alloyed < 3% Si				✓
	N1.2	Aluminium, alloyed < 7% Si				✓
	N1.3	Aluminium, alloyed > 7 - 12% Si				✓
	N1.4	Aluminium, alloyed > 12% Si				✓
	N2.1	Copper, unalloyed and low alloyed	< 300			✓
	N2.2	Copper, alloyed	> 300			✓
	N2.3	Brass, bronze, gunmetal	< 1,200			✓
	N3.1	Graphite, > 8 µm				✓
	N3.2	Graphite, ≤ 8 µm				✓
	N4.1	Plastic, thermoplastics				✓
N4	N4.2	Plastic, duroplastics				✓
	N4.3	Plastic, foam materials				✓

\* MAPAL machining groups

\*\* If the alloy parts Cr, Mo, Ni, V, W are in total > 8%, select the next highest MAPAL machining group.

v <sub>c</sub> [m/min] according to cutting material type and contact ratio a <sub>e</sub> /D																				
Carbide PVD-coated										Carbide CVD-coated						Carbide uncoated		PCD		
HP615		HP965		HP975		HP980		HP985		HC760		HC770		HC775		HU616		PU617		
> 0.6	< 0.6	> 0.6	< 0.6	> 0.6	< 0.6	> 0.6	< 0.6	> 0.6	< 0.6	> 0.6	< 0.6	> 0.6	< 0.6	> 0.6	< 0.6	> 0.6	< 0.6	> 0.6	< 0.6	
				180	220	180	220					260	280							
				150	180	150	180					250	270	240	260					
				160	200	160	200					240	260	230	250					
						130	160							220	240					
						130	160													
						130	160													
						120	150													
						120	150													
						130	160													
						110	140													
						160	180	140	170											
						140	160	120	150											
								100	120											
								90	110											
		220	270	200	240					330	350	320	330							
		200	240	180	220					300	330	300	320							
		180	220	160	200							260	300							
		160	200	140	170							220	260							
		170	210	150	180					210	240	200	220							
		160	200	140	170					200	220	180	200							
700	700															500	500	2,000	2,000	
400	480															300	360	1,500	1,800	
300	360															230	280	1,200	1,440	
270	330																	700	840	
250	300															250	300	600	720	
130	160															120	150	500	600	
190	230															180	220	450	540	
320	390															300	360			
320	390																			
220	270															300	360	500	600	
210	260															250	300	400	480	

The specified machining values are guide values.  
 The optimum data for the respective machining task should be determined during the test or machining.

# Cutting data recommendation for SPGN indexable inserts

Cutting speed

## SPGN

MMG*		Workpiece material	Strength/hardness [N/mm <sup>2</sup> ] [HRC]
K	K1	K1.1 Cast iron with lamellar graphite (grey cast iron), GJL	< 300
		K2.1 Cast iron with spheroidal graphite, GJS	< 500
	K2	K2.2 Cast iron with spheroidal graphite, GJS	≤ 800
		K2.3 Cast iron with spheroidal graphite, GJS	> 800
	K3	K3.1 Cast iron with vermicular graphite, GJV; malleable cast iron, GJM	< 500
		K3.2 Cast iron with vermicular graphite, GJV; malleable cast iron, GJM	> 500

























Carbide PVD-coated	
HP968	
>0.6	<0.6
220	270
200	240
180	220
160	200
170	210
160	200







The specified cutting data are guide values.  
 The optimum data for the respective machining task should be determined during the test or machining.

# Bore machining pictograms

**Drilling from solid** >

































	Drilling from solid		Spot drilling		Stepped drilling		Deep drilling
	Drilling reaming <b>H7</b>		High-feed machining <b>HFC</b>		High-speed machining <b>HSC</b>		Stack bores
	Cross bore		Inclined bore entrance		Inclined bore outlet		Flat bottom of the bore <b>180°</b>
	Maximum achievable bore tolerance $\geq IT$		Maximum drilling depth <b>3xD</b>		Coolant supply		With indexable insert
	QTS connection		TTS-100 connection <b>TTS-100</b>		TTS-300 connection <b>TTS-300</b>		Shank form HA according to DIN <b>HA</b> <b>DIN 6535</b>
	Shank form HB according to DIN <b>HB</b> <b>DIN 6535</b>		Shank form HE according to DIN <b>HE</b> <b>DIN 6535</b>				

**Reaming and fine boring** >

	Through hole		Blind bore		Preferred series in H7		Maximum achievable bore tolerance $\geq IT$
	Tool grinding diameter tolerance <b>Grind</b>		Coolant supply		Cylindrical shank HA in accordance with DIN <b>HA</b> <b>DIN 6535</b>		



# Milling pictograms

Milling

	Face milling		Shoulder milling		Groove milling		Trimming
	Chamfering and deburring		Profile milling		Plunge milling		Ramps
	Helix milling		Trochoidal milling		High-feed milling		Pocket milling
	Spot drilling		Corner radius		45° chamfer		Sharp-edged
	Process conditions good		Process conditions unfavourable		Roughing		Medium machining
	Finishing		Internal cooling		Shank form HA compatible with DIN 6535		Shank form HB compatible with DIN 6535
	Safe-Lock connection		CFS/MFS connection		Short		Long
	Overlong		Extra long		Maximum machining depth		Design DIN 6527



# General pictograms

**Configuration**   Product with configurable features

**Product category**   **Basic Line:**  
Universal tools, broad field of application, low procurement costs

 **Performance Line:**  
High-performance tools, broad field of application, high productivity in series production

 **Expert Line:**  
Specialist tools for selected applications, maximum precision and productivity

**Material suitability**   Highly suitable  Suitable in some situations

E.g. Standard material suitability table

<b>P</b>	1	2	3	4	5	6	<b>M</b>	1	2	3	<b>K</b>	1	2	3	<b>N</b>	1	2	3	4	<b>S</b>	1	2	3	4	5	<b>H</b>	1	2	3
	■	■	■	■								■	■																

E.g. Material suitability table for non-ferrous metal and lightweight materials

<b>N</b>	1.1	1.2	1.3	1.4	2.1	2.2	2.3	3.1	4.1	4.2	4.3	<b>C</b>	1.1	1.2	1.3	2.1	3.1	4.1	4.2	5.1	5.2	5.3
										■		■				■		■	■			

# MAPAL machining groups

Machining group	Workpiece material	Strength/hardness [N/mm <sup>2</sup> ] [HRC]	Frequently machined workpiece materials	
P	P1.1	Structural, machining, case hardened and tempering steels, unalloyed	< 700 N/mm <sup>2</sup>	1.0122 (S235/St 37), 1.0401 (C15), 1.0503 (C45), 1.0570 (S355/St 52), 1.1213 (Cf53)
	P1.2	Structural, machining, case hardened and tempering steels, unalloyed	< 1,200 N/mm <sup>2</sup>	1.1249 (Cf70)
	P2.1	Nitriding, hardening and tempering steels, alloyed	< 900 N/mm <sup>2</sup>	1.7131 (16MnCr5)
	P2.2	Nitriding, hardening and tempering steels, alloyed	< 1,400 N/mm <sup>2</sup>	1.7227 (42CrMoS4)
	P3.1	Tool steels, roller bearing steels, spring steels and high-speed steels*	< 800 N/mm <sup>2</sup>	1.2343 (X37CrMoV5-1), 1.2762 (75CrMoNiW6-7)
	P3.2	Tool steels, roller bearing steels, spring steels and high-speed steels*	< 1,000 N/mm <sup>2</sup>	1.2367 (X38CrMoV5-3), 1.2713 (55NiCrMoV6)
	P3.3	Tool steels, roller bearing steels, spring steels and high-speed steels*	< 1,500 N/mm <sup>2</sup>	1.2379 (X153CrMoV12), 1.2738 (40CrMnNiMo8-6-4)
P4	P4.1	Stainless steels, ferritic and martensitic		1.4510 (X3CrTi17), 1.4589 (X5CrNiMoTi15-2)
P5	P5.1	Cast steel		1.7231 (G42CrMo4)
P6	P6.1	Stainless cast steels, ferritic and martensitic		
M	M1.1	Stainless steels, austenitic	< 700 N/mm <sup>2</sup>	1.4301 (V2A), 1.4571 (V4A)
	M1.2	Stainless steels, ferritic/austenitic (duplex)	< 1,000 N/mm <sup>2</sup>	1.4362 (Alloy 2304), 1.4501, 1.4662 (LDX 2404)
	M2.1	Stainless cast steel, austenitic	< 700 N/mm <sup>2</sup>	
M3	M3.1	Stainless cast steel, ferritic/austenitic (duplex)	< 1,000 N/mm <sup>2</sup>	
K	K1.1	Cast iron with lamellar graphite (grey cast iron), GJL	< 300 N/mm <sup>2</sup>	GJL-250 (GG-25), GJL-260 (GG-26 Cr)
	K2.1	Cast iron with spheroidal graphite, GJS	< 500 N/mm <sup>2</sup>	GJS-400 (GGG-40), GJS-450 (GGG-45)
	K2.2	Cast iron with spheroidal graphite, GJS	≤ 800 N/mm <sup>2</sup>	GJS-600 (GGG-60), GJS-800-2 (GGG-80), GJS-800-8 (ADI 800)
	K2.3	Cast iron with spheroidal graphite, GJS	> 800 N/mm <sup>2</sup>	GJS-900-2 (GGG-90), GJS-1000-5 (ADI 1000), GJS-1200-2 (ADI 1200), GJS-1400-1 (ADI 1400)
	K3.1	Cast iron with vermicular graphite, GJV; malleable cast iron, GJM	< 500 N/mm <sup>2</sup>	GJV-300, GJV-400, GJMW-400-5 (GTW-40)
K3.2	Cast iron with vermicular graphite, GJV; malleable cast iron, GJM	> 500 N/mm <sup>2</sup>	GJV-500, GJV-700	
N	N1.1	Aluminium, unalloyed and alloyed < 3% Si		Alloy 2024, Alloy 7075, A199
	N1.2	Aluminium, alloyed ≤ 7% Si		AlSi7
	N1.3	Aluminium, alloyed > 7 - 12% Si		AlSi9, AlSi9Cu
	N1.4	Aluminium, alloyed > 12% Si		AlSi12, AlSi17
	N2.1	Copper, unalloyed and low alloyed	< 300 N/mm <sup>2</sup>	SE-Cu
	N2.2	Copper, alloyed	> 300 N/mm <sup>2</sup>	CuSn6
	N2.3	Brass, bronze, gunmetal	< 1,200 N/mm <sup>2</sup>	CuZn33, CuAl9Mn3
	N3.1	Graphite, > 8 µm		
	N3.2	Graphite, ≤ 8 µm		
	N4.1	Plastic, thermoplastics		PA, PE, PC, PS, PVC, PP, PTFE, POM, PMMA
N4.2	Plastic, duroplastics		PU, PF, EP, UP, VE, CR	
N4.3	Plastic, foam materials		EPS, PUR, PVC-E, PS-E, PP-E	
C	C1.1	Plastic range, reinforced with aramid fibre (AFK)		Nomex, Kevlar, Twaron, KOREX
	C1.2	Plastic range (duroplastic), CFK/GFK		IMS, HTA
	C1.3	Plastic range (thermoplastic), CFK/GFK		GMT-PP, PEEK
	C2.1	Carbon range, reinforced with carbon fibre (CFC)		CF222, CF225, CF226, CF227, CF260
	C3.1	Metal matrix (MMC)		CeramTec AO-403 (AlSi9MgMn-Al2O3), Al/Cu/Mg-SiO2/Al2O3/AlN/TiC/SiC/BN/TiB2
	C4.1	Sandwich construction, honeycomb core (Honeycomb)		
	C4.2	Sandwich construction, foam core		PLASCORE PAMG-XR1 5052, PCGA-XR1 3003, PAMG-XR1 5056, Micro-Cell (core made of alloy 5052/5056)
	C5.1	Multilayer composite (stack), non-metallic non-ferrous metal composite		CFK-aluminium, IMS/HTA + Alloy 2024/6061/7075
	C5.2	Multilayer composite (stack), non-metallic metal composite		CFK-titanium, IMS/HTA + TiAl6V4/AMS4905
	C5.3	Multilayer composite (stack), non-metallic non-metal composite		CFK-CFK
	C5.4	Multilayer composite (stack), non-ferrous metallic non-ferrous metal composite		Aluminium-aluminium
C5.5	Multilayer composite (stack), non-ferrous metallic metal composite		Aluminium-titanium	
C5.6	Multilayer composite (stack), metallic metal composite		Titanium Inox	
S	S1.1	Titanium, titanium alloys	< 400 N/mm <sup>2</sup>	
	S2.1	Titanium, titanium alloys	< 1,200 N/mm <sup>2</sup>	TiAl6V4
	S2.2	Titanium, titanium alloys	> 1,200 N/mm <sup>2</sup>	
	S3.1	Nickel, unalloyed and alloyed	< 900 N/mm <sup>2</sup>	1.3912 (Invar, Ni36)
	S3.2	Nickel, unalloyed and alloyed	> 900 N/mm <sup>2</sup>	
S4.1	High-temperature super alloy, Ni-, Co-, and Fe-based		Hardox, Hastelloy, Incoloy, Inconel, NIMONIC, Stellite, Waspaloy	
S5.1	Molybdenum and tungsten alloys			
H	H1.1	Hardened steel / cast steel	< 44 HRC	1.2738 HH, 1.2085, Toolox 33, Toolox 44
	H1.2	Hardened steel / cast steel	< 55 HRC	1.2343, 1.2311, 1.2312, 1.2714, 1.2083, 1.2738
	H2.1	Hardened steel / cast steel	< 60 HRC	1.1730, 1.2379, 1.2358, 1.2767, 1.4112, ASP 2012
	H2.2	Hardened steel / cast steel	< 65 HRC	1.2379, 1.2363, 1.2436, 1.2842, ASP 2005, Vanadis 23
	H2.3	Hardened steel / cast steel	< 68 HRC	ASP 2017, ASP 2023, Vanadis 30, Vanadis 60
H3.1	Wear-resistant cast / chill casting, GJN			

\* If the alloy parts Cr, Mo, Ni, V, W are in total > 8%, select the next highest MAPAL machining group.



Discover tool and service solutions now that give you a lead:

## BORE MACHINING

REAMING | FINE BORING

DRILLING FROM SOLID | BORING | COUNTERSINKING

MILLING

CLAMPING

TURNING

ACTUATING

SETTING | MEASURING | DISPENSING

SERVICES

FOLLOW US

